



HP Officejet 8040 e-All-in-One series



---

# Table of contents

<b>1 How do I?</b> .....	<b>1</b>
<b>2 Get started</b> .....	<b>2</b>
Printer parts .....	3
Control panel and status lights .....	5
Use Neat® on HP Officejet 8040 .....	8
Paper basics .....	9
Load media .....	12
Load original .....	17
Open the HP printer software (Windows) .....	18
Sleep mode .....	19
Accessibility .....	20
<b>3 Print</b> .....	<b>21</b>
Print photos .....	22
Print documents .....	24
Print on both sides (duplexing) .....	25
Print using Near Field Communication (NFC) .....	26
Print with AirPrint .....	27
Print using the maximum dpi .....	28
Tips for print success .....	29
<b>4 Copy and scan</b> .....	<b>31</b>
Copy documents .....	32
Scan .....	33
Tips for copy and scan success .....	38
<b>5 Use Web Services</b> .....	<b>39</b>
What are Web Services? .....	40
Set up Web Services .....	41
Print with HP ePrint .....	43

Use HP Printables .....	45
Use the HP Connected website .....	46
Remove Web Services .....	47
Tips for using Web Services .....	48
<b>6 Fax .....</b>	<b>49</b>
Send a fax .....	50
Receive a fax .....	55
Set up phone book contacts .....	61
Change fax settings .....	64
Fax and digital phone services .....	68
Fax over Internet Protocol .....	69
Use reports .....	70
<b>7 Work with cartridges .....</b>	<b>74</b>
Check the estimated ink levels .....	75
Replace the cartridges .....	76
Order ink supplies .....	78
Use single-cartridge mode .....	79
Cartridge warranty information .....	80
Anonymous usage information storage .....	81
Tips for working with cartridges .....	82
<b>8 Connect Your Printer .....</b>	<b>83</b>
Set up the printer for wireless communication .....	84
Change network settings .....	90
Advanced printer management tools (for networked printers) .....	92
Tips for setting up and using a networked printer .....	94
<b>9 Solve a problem .....</b>	<b>95</b>
Jams and paper-feed issues .....	96
Ink cartridge issues .....	102
Printing issues .....	104
Copy issues .....	112
Scan issues .....	113
Fax issues .....	114
Network and connection issues .....	124
Printer hardware issues .....	126
HP support .....	128

<b>Appendix A Technical information</b> .....	<b>130</b>
Hewlett-Packard Company notices .....	131
Specifications .....	132
Environmental product stewardship program .....	134
Regulatory information .....	137
<b>Appendix B Additional fax setup</b> .....	<b>141</b>
Set up faxing (parallel phone systems) .....	142
Serial-type fax setup .....	165
Test fax setup .....	166
<b>Appendix C Errors (Windows)</b> .....	<b>167</b>
Low on ink .....	168
Very low on ink .....	169
Ink cartridge problem .....	170
Paper size mismatch .....	171
Ink cartridge carriage stalled .....	172
Paper jam or tray problem .....	173
Out of paper .....	174
Document failed to print .....	175
Printer failure .....	176
Door open .....	177
Ink cartridge failure .....	178
Counterfeit Cartridge Advisory .....	179
Incompatible ink cartridges .....	180
Paper too short .....	181
Paper too long to auto-duplex .....	182
Incompatible HP Instant Ink Cartridge .....	183
Used HP Instant Ink Cartridge .....	184
Please Connect Printer to HP Connected .....	185
Cannot Print .....	186
HP Protected Cartridge Installed .....	187
<b>Index</b> .....	<b>188</b>



---

# 1 How do I?

Learn how to use your HP Officejet 8040 series

- [Get started on page 2](#)
- [Print on page 21](#)
- [Use Web Services on page 39](#)
- [Copy and scan on page 31](#)
- [Fax on page 49](#)
- [Work with cartridges on page 74](#)
- [Connect Your Printer on page 83](#)
- [Technical information on page 130](#)
- [Solve a problem on page 95](#)

---

## 2 Get started

This section contains the following topics:

- [Printer parts](#)
- [Control panel and status lights](#)
- [Use Neat® on HP Officejet 8040](#)
- [Paper basics](#)
- [Load media](#)
- [Load original](#)
- [Open the HP printer software \(Windows\)](#)
- [Sleep mode](#)
- [Accessibility](#)



# Printer parts

## Front view

Figure 2-1 Front and top views of HP Officejet 8040 e-All-in-One series

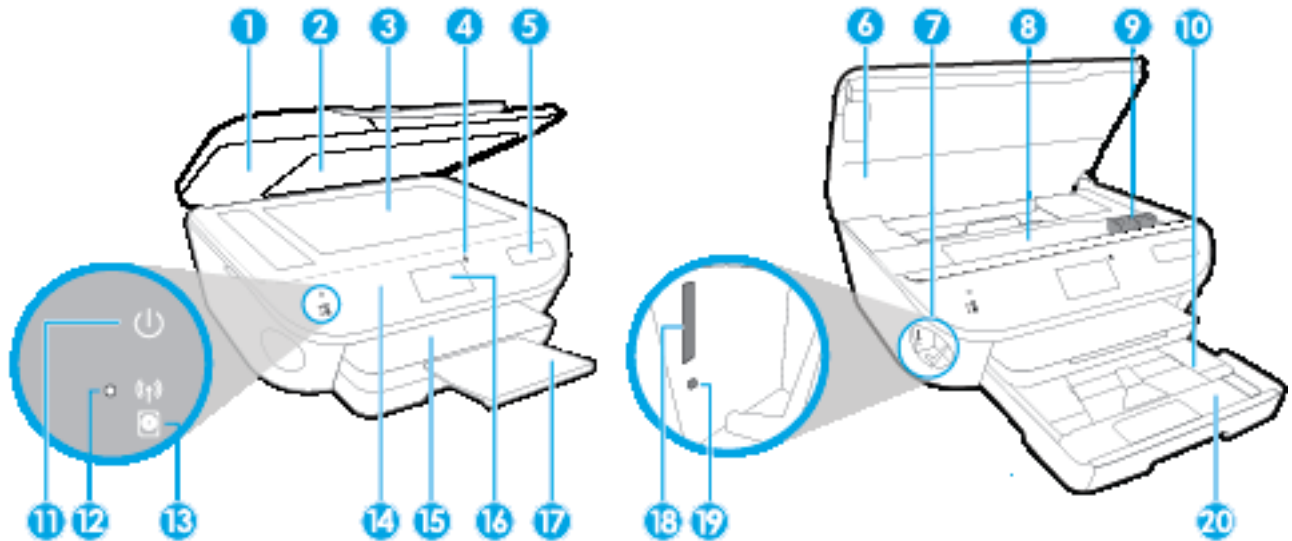

Feature	Description
1	Lid
2	Lid-backing
3	Scanner glass
4	Near Field Communication (NFC) button
5	Printer model name
6	Cartridge access door
7	Memory device area
8	Cartridge access area
9	Ink cartridges
10	Photo tray
11	On button (also referred to as the Power button)
12	Wireless status light
13	HP Officejet 8040 hard drive status light
14	Control panel
15	Output tray
16	Color graphics display (also referred to as the display)
17	Automatic output tray extender (also referred to as the tray extender)
18	Memory card slot

Feature	Description
19	Memory device light
20	Paper tray

## Back view

Figure 2-2 Rear view of HP Officejet 8040 e-All-in-One series

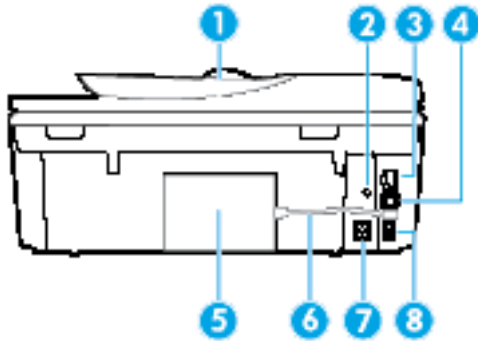

Feature	Description
1	Document feeder
2	Power light. The green light indicates the power cord is installed correctly.
3	Ethernet network port
4	Rear USB port
5	HP Officejet 8040 hard drive
6	HP Officejet 8040 hard drive USB cable
7	Power connection. Use only the power cord supplied by HP.
8	Fax ports: 2-EXT (top) and 1-LINE (bottom)

# Control panel and status lights

## Overview of buttons and lights

The following diagram and related table provides a quick reference to the printer control panel features.

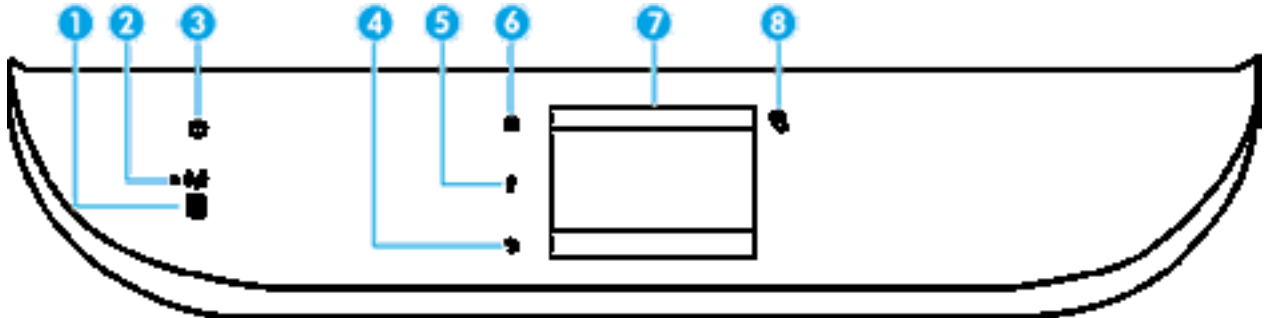









Label	Name and Description
1	HP Officejet 8040 hard drive status light
2	Wireless light: Indicates the status of the printer wireless connection. <ul style="list-style-type: none"><li>• Solid blue light indicates that wireless connection has been established and you can print.</li><li>• Slow blinking light indicates that wireless is on, but the printer is not connected to a network. Make sure your printer is within the range of wireless signal.</li><li>• Fast blinking light indicates wireless error. Refer to the message on the printer display.</li><li>• If wireless is turned off, the wireless light is off and the display screen shows <b>Wireless Off</b>.</li></ul>
3	<b>On</b> button: Turns the printer on or off.
4	<b>Back</b> button: Returns to the previous screen.
5	<b>Help</b> button: Opens the Help menu for the current operation.
6	<b>Home</b> button: Returns to the Home screen, the screen that is displayed when you first turn on the printer.
7	<b>Control panel display</b> : Touch the screen to select menu options, or scroll through the menu items.
8	<b>Near Field Communication (NFC)</b> button: Indicates the area where you can print documents and images from a mobile device (such as a smartphone or tablet) by touching the device on the printer.

## Control panel display icons



Icon	Purpose
	<b>Copy:</b> Opens the <b>Copy</b> menu where you can select a copy type or change the copy settings.
	<b>Scan:</b> Opens the <b>Scan</b> menu where you can select a destination for your scan.
	<b>Neat®:</b> Initiates scanning of your receipts, business cards, invoices, and other documents to <b>Neat®</b> , to easily organize and manage these documents.
	<b>HP Printables:</b> Provides a quick and easy way to access and print information from the web, such as coupons, coloring pages, puzzles, and more.
	<b>Photo:</b> Opens the <b>Photo</b> menu where you can view and print photos, or reprint a printed photo.
	<b>Fax:</b> Displays a screen where you can send a fax, or change fax settings.
	<b>Setup:</b> Opens the <b>Setup</b> menu where you can change preferences and use tools to perform maintenance functions.
	<b>Help:</b> Opens the Help menu where you can view How To videos, printer feature information, and tips.
	Near Field Communication (NFC) button: Indicates the area where you can print documents and images from a mobile device (such as a smartphone or tablet) by touching the device on the printer.
	ePrint icon: Opens the <b>Web Services Summary</b> menu, where you can check ePrint status details, change ePrint settings, or print an Info page.

Icon	Purpose
	Wi-Fi Direct icon: Opens the <b>Wi-Fi Direct</b> menu where you can turn on Wi-Fi Direct, turn off Wi-Fi Direct, and display the Wi-Fi Direct name and password.
	<p>Wireless icon: Opens the <b>Wireless Summary</b> menu where you can check wireless status and change wireless settings. You can also print a wireless test report, helping diagnose network connection issues.</p> <p><b>NOTE:</b>  (Ethernet) and  (Wireless) will not be displayed at the same time. Showing the Ethernet icon or the wireless icon depends on the way your printer is connected to the network. If the network connection of the printer has not been set up, by default, the printer control panel display shows  (Wireless).</p>
	Ethernet icon: Shows that an Ethernet network connection exists and also provides easy access to the network status screen.
	HP Officejet 8040 hard drive status icon: Displays status information for the Neat® function.
	Fax Status icon: Displays status information for the Auto Answer function, fax logs, and the fax sound volume.
	<p>Ink icon: Shows estimated ink levels by cartridge. Displays a warning symbol if the ink level is less than the minimum expected ink level.</p> <p><b>NOTE:</b> Ink level warnings and indicators provide estimates for planning purposes only. When you receive a low-ink warning message, consider having a replacement cartridge available to avoid possible printing delays. You do not need to replace cartridges until the print quality becomes unacceptable.</p>

## Use Neat® on HP Officejet 8040

The HP Officejet 8040 series printer includes an account and access to the Neat® Digital Filing System and functionality to scan receipts, business cards, and other documents directly to the Neat® service. By registering the printer and setting up an HP Connected account, you also setup a Neat® account to enable scanning directly to your account from the HP Officejet 8040 series.

The Neat® service organizes your scanned information and also provides a variety of other services to increase your productivity. Go to [www.neat.com](http://www.neat.com) for additional information on the Neat® service.

All documents in your Neat® account are also stored on the 1TB hard drive that is attached to your HP Officejet 8040 series. You can add files to your Neat® account by scanning directly from the printer, using the NeatMobile®, or using a web browser.

Learn more about Neat®. [Click here to go online for more information.](#)

# Paper basics

The printer is designed to work well with most types of office paper. It is best to test a variety of print paper types before buying large quantities. Use HP paper for optimum print quality. Visit the HP website at [www.hp.com](http://www.hp.com) for more information about HP paper.



HP recommends plain papers with the ColorLok logo for printing everyday documents. All papers with the ColorLok logo are independently tested to meet high standards of reliability and print quality, and produce documents with crisp, vivid color, bolder blacks, and that dry faster than ordinary plain papers. Look for papers with the ColorLok logo in a variety of weights and sizes from major paper manufacturers.

This section contains the following topics:

- [Recommended papers for printing](#)
- [Order HP paper supplies](#)
- [Tips for selecting and using paper](#)

## Recommended papers for printing

If you want the best print quality, HP recommends using HP papers that are specifically designed for the type of project you are printing.

Depending on your country/region, some of these papers might not be available.

### Photo printing

- **HP Premium Plus Photo Paper**

HP Premium Plus Photo Paper is HP's highest-quality photo paper for your best photos. With HP Premium Plus Photo Paper, you can print beautiful photos that are instant-dry so you can share them right off the printer. It is available in several sizes, including A4, 8.5 x 11 inches, 4 x 6 inches (10 x 15 cm), 5 x 7 inches (13 x 18 cm), and 11 x 17 inches (A3), and in two finishes - glossy or soft gloss (semi-gloss). Ideal for framing, displaying, or gifting your best photos and special photo projects. HP Premium Plus Photo Paper delivers exceptional results with professional quality and durability.

- **HP Advanced Photo Paper**

This thick photo paper features an instant-dry finish for easy handling without smudging. It resists water, smears, fingerprints, and humidity. Your prints have a look and feel comparable to a store-processed photo. It is available in several sizes, including A4, 8.5 x 11 inches, 10 x 15 cm (4 x 6 inches), 13 x 18 cm (5 x 7 inches), and two finishes - glossy or soft-gloss (satin matte). It is acid-free for longer lasting documents.

- **HP Everyday Photo Paper**

Print colorful, everyday snapshots at a low cost, using paper designed for casual photo printing. This affordable photo paper dries quickly for easy handling. Get sharp, crisp images when you

use this paper with any inkjet printer. It is available in glossy finish in several sizes, including A4, 8.5 x 11 inches, and 10 x 15 cm (4 x 6 inches). It is acid-free for longer lasting documents.

- **HP Photo Value Packs**

HP Photo Value Packs conveniently package original HP ink cartridges and HP Advanced Photo Paper to save you time and take the guesswork out of printing affordable, lab-quality photos with your HP printer. Original HP inks and HP Advanced Photo Paper have been designed to work together so your photos are long lasting and vivid, print after print. Great for printing out an entire vacation's worth of photos or multiple prints to share.

## Business documents

- **HP Premium Presentation Paper 120g Matte**

This paper is a heavy two-sided matte paper perfect for presentation, proposals, reports, and newsletters. It is heavyweight for an impressive look and feel.

- **HP Brochure Paper 180g Glossy or HP Professional Paper 180 Glossy**

These papers are glossy-coated on both sides for two-sided use. They are the perfect choice for near-photographic reproductions and business graphics for report covers, special presentations, brochures, mailers, and calendars.

- **HP Brochure Paper 180g Matte or HP Professional Paper 180 Matt**

These papers are matte-coated on both sides for two-sided use. They are the perfect choice for near-photographic reproductions and business graphics for report covers, special presentations, brochures, mailers, and calendars.

## Everyday printing

All the papers listed for everyday printing feature ColorLok Technology for less smearing, bolder blacks, and vivid colors.

- **HP Bright White Inkjet Paper**

HP Bright White Inkjet Paper delivers high-contrast colors and sharp text. It is opaque enough for two-sided color usage with no show-through, which makes it ideal for newsletters, reports, and flyers.

- **HP Printing Paper**

HP Printing Paper is a high-quality multifunction paper. It produces documents that look and feel more substantial than documents printed on standard multipurpose or copy paper. It is acid-free for longer lasting documents.

- **HP Office Paper**

HP Office Paper is a high-quality multifunction paper. It is suitable for copies, drafts, memos, and other everyday documents. It is acid-free for longer lasting documents.

- **HP Office Recycled Paper**

HP Office Recycled Paper is a high-quality multifunction paper made with 30% recycled fiber.



## Order HP paper supplies

The printer is designed to work well with most types of office paper. Use HP paper for optimum print quality.

To order HP papers and other supplies, go to [www.hp.com](http://www.hp.com). At this time, some portions of the HP website are available in English only.

HP recommends plain papers with the ColorLok logo for printing and copying of everyday documents. All papers with the ColorLok logo are independently tested to meet high standards of reliability and print quality, and produce documents with crisp, vivid color, bolder blacks and dry faster than ordinary plain papers. Look for papers with the ColorLok logo in a variety of weights and sizes from major paper manufacturers.

## Tips for selecting and using paper

For the best results, observe the following guidelines.

- Load only one type of paper at a time into a tray or document feeder.
- When loading the tray and document feeder, make sure the paper is loaded correctly.
- Do not overload the tray or document feeder.
- To prevent jams, poor print quality, and other printing problems, avoid loading the following paper in the tray or document feeder:
  - Multipart forms
  - Media that is damaged, curled, or wrinkled
  - Media with cutouts or perforations
  - Media that is heavily textured, embossed, or does not accept ink well
  - Media that is too lightweight or stretches easily
  - Media that contains staples or clips

# Load media

Select a paper size to continue.

## To load small-size paper

1. Pull out the photo tray.

Slide the paper-width guides outward, and then remove any previously loaded media.

If you do not see the photo tray, remove the output tray from the printer.

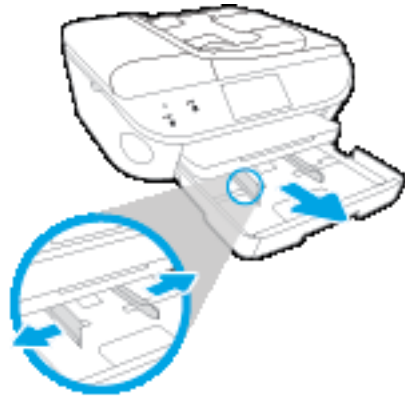

2. Load paper.

- Insert a stack of photo paper into the photo tray print side down.



- Slide the photo paper forward until it stops.
- Slide the paper-width guides inward until they stop at the edges of the paper.

3. Push the photo tray back in.
4. Change or retain the paper settings on the printer display.

## To load full-size paper

1. Pull out the paper tray, slide the paper-width guides outward, and then remove any previously loaded media.

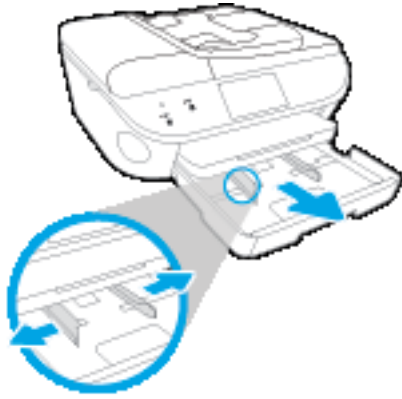

2. Load paper.

- Insert a stack of paper into the paper tray with the short edge forward and the print side down.
- Slide the paper forward until it stops.
- Slide the paper-width guides inward until they stop at the edges of the paper.

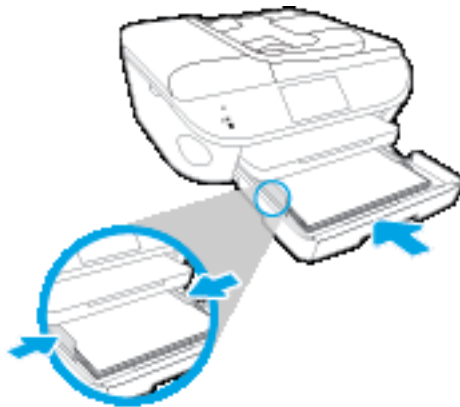

3. Push the paper tray back in.

4. Change or retain the paper settings on the printer display.

**To load legal paper**

1. Pull out the paper tray, slide the paper-width guides outward, and then remove any previously loaded media.

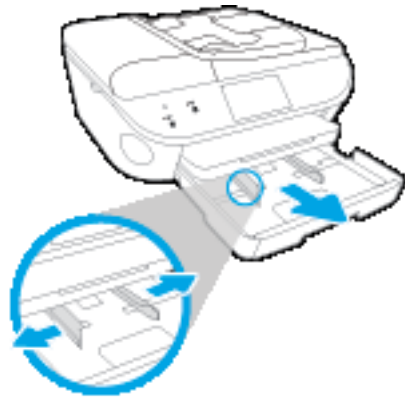

2. Unlock and open the front side of the paper tray.



3. Load paper.

- Insert a stack of paper into the paper tray with the short edge forward and the print side down.
- Slide the paper forward until it stops.



- Slide the paper-width guides inward until they stop at the edges of the paper.

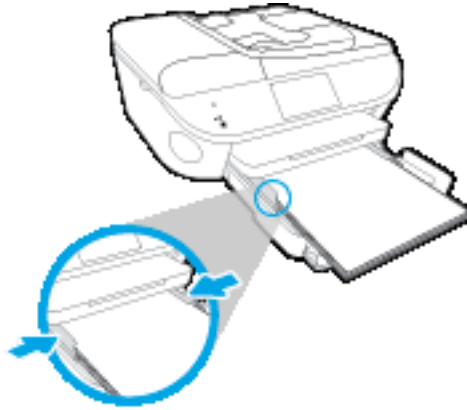

4. Push the paper tray back in.
5. Change or retain the paper settings on the printer display.

### To load envelopes

1. Pull out the paper tray, slide the paper-width guides outward, and then remove any previously loaded media.

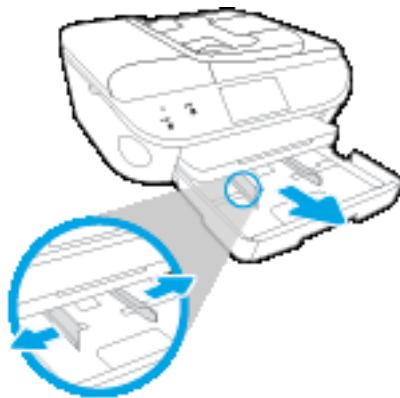

2. Load envelopes

- Insert one or more envelopes in the center of the paper tray. The print side should face down. The flap should be on the left side and facing up.
- Slide a stack of envelopes inward until it stops.

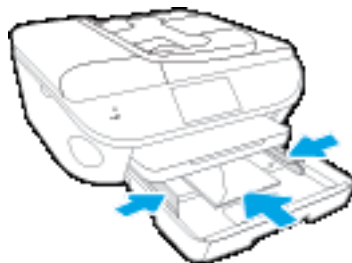

- Slide the paper-width guides inward against the stack of envelopes until they stop.

3. Push the paper tray back in.
4. Change or retain the paper settings on the printer display.

# Load original

## To load original on the scanner glass

1. Lift the scanner lid.



2. Load the original print side down on the right front corner of the glass.

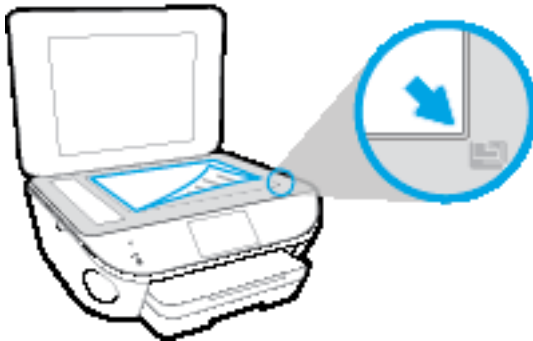

3. Close the scanner lid.

## To load an original in the document feeder

1. Slide paper-width guides outwards.
2. Load original print-side up in the document feeder.



3. Slide paper-width guides inward until they stop at the edge of paper.

## Open the HP printer software (Windows)

After installing the HP printer software, depending on your operating system, do one of the following:

- **Windows 8.1:** Click the down arrow in lower left corner of the Start screen, and then select the printer name.
- **Windows 8:** Right-click an empty area on the Start screen, click **All Apps** on the app bar, and then select the printer name.
- **Windows 7, Windows Vista, and Windows XP:** From the computer desktop, click **Start**, select **All Programs**, click **HP**, click the folder for the printer, and then select the icon with the printer's name.



# Sleep mode

- Power usage is reduced while in the Sleep mode.
- After initial setup of printer, the printer will enter the Sleep mode after five minutes of inactivity.
- The time to the Sleep mode can be changed from the control panel.

## To set the Sleep mode time

1. From the Home screen, touch  (Setup).
2. Touch **Preferences**.
3. Scroll through the options, and then touch **Sleep Mode**.
4. Touch **After 5 minutes** or **After 10 minutes**, or **After 15 minutes**.

# Accessibility

The printer provides a number of features that make it accessible for people with disabilities.

## Visual

The HP software provided with the printer is accessible for users with visual impairments or low vision by using your operating system's accessibility options and features. The software also supports most assistive technology such as screen readers, Braille readers, and voice-to-text applications. For users who are color blind, colored buttons and tabs used in the HP software have simple text or icon labels that convey the appropriate action.

## Mobility

For users with mobility impairments, the HP software functions can be executed through keyboard commands. The HP software also supports Windows accessibility options such as StickyKeys, ToggleKeys, FilterKeys, and MouseKeys. The printer doors, buttons, paper trays, and paper-width guides can be operated by users with limited strength and reach.

## Support

For more details about the accessibility of this printer and HP's commitment to product accessibility, visit HP's website at [www.hp.com/accessibility](http://www.hp.com/accessibility).

For accessibility information for Mac OS X, visit the Apple website at [www.apple.com/accessibility](http://www.apple.com/accessibility).

---

## 3 Print

Most print settings are automatically handled by the software application. Change the settings manually only when you want to change print quality, print on specific types of paper, or use special features.

This section contains the following topics:

- [Print photos](#)
- [Print documents](#)
- [Print on both sides \(duplexing\)](#)
- [Print using Near Field Communication \(NFC\)](#)
- [Print with AirPrint](#)
- [Print using the maximum dpi](#)
- [Tips for print success](#)

# Print photos

Make sure photo paper is loaded into the photo tray.

## To print photos from a memory device

1. Insert a memory device into the slot.



2. On the printer display, select a photo that you want to print and touch **Continue**.
3. Specify the number of photos to print.
4. Touch  (**Edit**) to change brightness, crop, or rotate the selected photo, or touch  (**Print Settings**) to use such features as **Red Eye Removal** or **Photo Fix**.
5. Touch **Continue** and preview the selected photo.
6. Touch **Print** to begin printing.

## To print a photo from the printer software

1. From your software, select **Print**.
2. Make sure your printer is selected.
3. Click the button that opens the **Properties** dialog box.

Depending on your software application, this button might be called **Properties**, **Options**, **Printer Setup**, **Printer Properties**, **Printer**, or **Preferences**.

4. Select the appropriate options.
  - On the **Layout** tab, select **Portrait** or **Landscape** orientation.
  - On the **Paper/Quality** tab, select the appropriate paper type from the **Media** drop-down list in the **Tray Selection** area, and then select the appropriate print quality in the **Quality Settings** area.
  - Click **Advanced** to select the appropriate paper size from the **Paper Size** drop-down list.
5. Click **OK** to return to the **Properties** dialog box.
6. Click **OK**, and then click **Print** or **OK** in the **Print** dialog box.

---

 **NOTE:** After the printing is finished, remove unused photo paper from the photo tray. Store the photo paper so it does not start to curl, which could reduce the quality of your printout.

---

## To print a photo from the computer (OS X)

1. Load paper in the tray. For more information, see [Load media on page 12](#).
2. From the **File** menu in your software, choose **Print**.
3. Make sure your printer is selected.
4. Set the print options.

If you do not see options on the Print dialog, click **Show Details**.

---

 **NOTE:** The following options are available for a USB connected printer. Locations for the options can vary from one application to another.

---

- a. Choose the appropriate paper size in the **Paper Size** pop-up menu.

---

 **NOTE:** If you change the **Paper Size** ensure that you have loaded the correct paper and set the paper size on the printer control panel to match.

---

- b. Select an **Orientation**.
  - c. From the pop-up menu, choose **Paper Type/Quality**, and then choose the following settings:
    - **Paper Type:** The appropriate photo paper type
    - **Quality: Best** or **Maximum dpi**
    - Click the **Color Options** disclosure triangle, and then choose the appropriate **Photo Fix** option.
      - **Off:** applies no changes to the image.
      - **Basic:** automatically focuses the image; moderately adjusts image sharpness.
5. Select any other print settings you want, and then click **Print**.

# Print documents

Make sure paper is loaded into the paper tray.

## To print a document

1. From your software, select **Print**.
2. Make sure your printer is selected.
3. Click the button that opens the **Properties** dialog box.

Depending on your software application, this button might be called **Properties**, **Options**, **Printer Setup**, **Printer Properties**, **Printer**, or **Preferences**.

4. Select the appropriate options.
  - On the **Layout** tab, select **Portrait** or **Landscape** orientation.
  - On the **Paper/Quality** tab, select the appropriate paper type from the **Media** drop-down list in the **Tray Selection** area, and then select the appropriate print quality in the **Quality Settings** area.
  - Click **Advanced** to select the appropriate paper size from the **Paper Size** drop-down list.
5. Click **OK** to close the **Properties** dialog box.
6. Click **Print** or **OK** to begin printing.

## To print documents (OS X)

1. Load paper in the tray. For more information, see [Load media on page 12](#).
2. From the **File** menu in your software, choose **Print**.
3. Make sure your printer is selected.
4. Specify the page properties.

If you do not see options on the Print dialog, click **Show Details**.

---

 **NOTE:** The following options are available for a USB connected printer. Locations for the options can vary from one application to another.

---

- Choose the paper size.

---

 **NOTE:** If you change the **Paper Size** ensure that you have loaded the correct paper and set the paper size on the printer control panel to match.

---

- Select the orientation.
- Enter the scaling percentage.

5. Click **Print**.

---

 **NOTE:** If your printed documents are not aligned within the margins of the paper, make sure that you have selected the correct language and region. On the printer display, select **Settings**, and then select **Preferences**. Select your language, and then region from the options provided. The correct language and country/region settings ensure that the printer will have the appropriate default paper size settings.

---

# Print on both sides (duplexing)

## To print on both sides of the page

You can print on both sides of a sheet of paper automatically by using the automatic two-sided printing mechanism (duplexer).

1. From your software, select **Print**.
2. Make sure your printer is selected.
3. Click the button that opens the **Properties** dialog box.

Depending on your software application, this button might be called **Properties**, **Options**, **Printer Setup**, **Printer Properties**, **Printer**, or **Preferences**.

4. Select the appropriate options.
  - On the **Layout** tab, select **Portrait** or **Landscape** orientation, and select **Flip on Long Edge** or **Flip on Short Edge** from the **Print on Both Sides** drop-down list.
  - On the **Paper/Quality** tab, select the appropriate paper type from the **Media** drop-down list in the **Tray Selection** area, and then select the appropriate print quality in the **Quality Settings** area.
  - Click the **Advanced** button, in the **Paper/Output** area, select the appropriate paper size from the **Paper Size** drop-down list.

---

 **NOTE:** If you change the **Paper Size** ensure that you have loaded the correct paper and set the paper size on the printer control panel to match.

---

5. Click **OK** to print.

---

 **NOTE:** After one page of the document has been printed, wait for the printer to reload the paper automatically to print on the other side. You do not need to take any action.

---

## To print on both sides of the page (OS X)

1. From the **File** menu in your software, choose **Print**.
2. In the Print dialog, choose **Layout** from the pop-up menu.
3. Choose the type of binding you want for your two-sided pages, and then click **Print**.

## Print using Near Field Communication (NFC)

With near field communication (NFC), you can quickly print documents and images from a mobile device (such as a smartphone or tablet) just by touching the device on the printer. Look for  on the front of the printer, near the printer control panel, and then touch your mobile device to this area to print—no additional setup required.



**NOTE:** This feature is available with some models of the printer.

---

To use this feature, make sure your mobile device supports NFC and make sure NFC is turned on in the printer.



## Print with AirPrint

Printing using Apple's AirPrint is supported for iOS 4.2 and Mac OS X 10.7 or later. Use AirPrint to print wirelessly to the printer from an iPad (iOS 4.2), iPhone (3GS or later), or iPod touch (third generation or later) in the following mobile applications:

- Mail
- Photos
- Safari
- Supported third-party applications, for example Evernote

To use AirPrint, ensure the following:

- The printer and the Apple device must be connected to the same network as your AirPrint enabled device. For more information about using AirPrint and about which HP products are compatible with AirPrint, go to [www.hp.com/go/mobileprinting](http://www.hp.com/go/mobileprinting).
- Load paper that matches the paper settings of the printer.

# Print using the maximum dpi

Use maximum dots per inch (dpi) mode to print high-quality, sharp images on photo paper.

Printing in maximum dpi takes longer than printing with other settings and requires a large amount of disk space.

## To print in maximum dpi mode

1. From your software, select **Print**.
2. Make sure your printer is selected.
3. Click the button that opens the **Properties** dialog box.  
Depending on your software application, this button might be called **Properties**, **Options**, **Printer Setup**, **Printer Properties**, **Printer**, or **Preferences**.
4. Click the **Paper/Quality** tab.
5. From the **Media** drop-down list, select the appropriate paper type and print quality.
6. Click the **Advanced** button.
7. In the **Printer Features** area, select **Yes** from the **Print in Max DPI** drop-down list.
8. Select the appropriate paper size from the **Paper Size** drop-down list.
9. Click **OK** to close the advanced options.
10. Confirm **Orientation** on the **Layout** tab, and then click **OK** to print.

## To print using maximum dpi (OS X)

1. From the **File** menu in your software, choose **Print**.
2. Make sure your printer is selected.
3. Set the print options.

If you do not see options on the Print dialog, click **Show Details**.

---

 **NOTE:** The following options are available for a USB connected printer. Locations for the options can vary from one application to another.

---

- a. Choose the appropriate paper size in the **Paper Size** pop-up menu.

---

 **NOTE:** If you change the **Paper Size** ensure that you have loaded the correct paper and set the paper size on the printer control panel to match.

---

- b. From the pop-up menu, choose **Paper Type/Quality**, and then choose the following settings:
  - **Paper Type:** The appropriate paper type
  - **Quality:** **Maximum dpi**
4. Select any other print settings that you want, and then click **Print**.

# Tips for print success

Use the following tips to print successfully.

## Tips for printing from a computer

For more information on printing documents, photos, or envelopes from a computer, use the following links to operating-system specific instructions.

- Learn how to print photos saved on your computer. [Click here to go online for more information.](#)
- Learn how to print envelopes from your computer. [Click here to go online for more information.](#)

## Tips for ink and paper

- Use original HP cartridges. Original HP cartridges are designed for and tested with HP printers to help you produce great results, time after time.
- Make sure the cartridges have sufficient ink. To view the estimated ink levels, touch  (Ink) from the Home screen.

To learn more tips about working with cartridges, see [Tips for working with cartridges on page 82](#) for more information.

- Load a stack of paper, not just one page. Use clean and flat paper of the same size. Make sure only one type of paper is loaded at a time.
- Adjust the paper-width guides in the paper tray to fit snugly against all paper. Make sure the paper-width guides do not bend the paper in the paper tray.
- Set the print quality and paper size settings according to the type and size of paper loaded in the paper tray.

## Printer settings tips

- On the **Paper/Quality** tab, select the appropriate paper type from the **Media** drop-down list in the **Tray Selection** area, and then select the appropriate print quality in the **Quality Settings** area.
- Select the appropriate paper size from the **Paper Size** drop-down list in the **Advanced Options** dialog box. Access the **Advanced Options** dialog box by clicking the **Advanced** button on the **Layout** or **Paper/Quality** tab.
- To change default print settings, click **Print, Scan & Fax**, and then click **Set Preferences** in the printer software.

Depending on your operating system, do one of the following to open the printer software:

- **Windows 8.1:** Click the down arrow in lower left corner of the Start screen, and then select the printer name.
- **Windows 8:** On the **Start** screen, right-click an empty area on the screen, click **All Apps** on the app bar, and then click the icon with the printer's name.
- **Windows 7, Windows Vista, and Windows XP:** From the computer desktop, click **Start**, select **All Programs**, click **HP**, click **HP Officejet 8040 series**, and then click **HP Officejet 8040 series**.
- If you want to print a black and white document using black ink only, click the **Advanced** button. From the **Print in Grayscale** drop-down menu, select **Black Ink Only**, then click the **OK** button.

### Printer settings tips

- On the Print dialog, use the **Paper Size** pop-up menu to select the size of paper loaded in the printer.
- On the Print dialog, choose the **Paper Type/Quality** pop-up menu and select the appropriate paper type and quality.
- To print a black and white document using only black ink, choose the **Paper Type/Quality** from the pop-up menu and choose **Grayscale** from the Color pop-up menu.

### Notes

- Original HP ink cartridges are designed and tested with HP printers and papers to help you easily produce great results, time after time.

---

 **NOTE:** HP cannot guarantee the quality or reliability of non-HP supplies. Product service or repairs required as a result of using a non-HP supply will not be covered under warranty.

If you believe you purchased original HP ink cartridges, go to:

[www.hp.com/go/anticounterfeit](http://www.hp.com/go/anticounterfeit)

---

- Ink level warnings and indicators provide estimates for planning purposes only.

---

 **NOTE:** When you receive a low-ink warning message, consider having a replacement cartridge available to avoid possible printing delays. You do not need to replace the cartridges until print quality becomes unacceptable.

---

- Software settings selected in the print driver only apply to printing, they do not apply to copying or scanning.
- You can print your document on both sides of the paper.

---



# 4 Copy and scan

- [Copy documents](#)
- [Scan](#)
- [Tips for copy and scan success](#)

# Copy documents

The **Copy** menu on the printer display allows you to easily select number of copies and color or black and white for copying on plain paper. You can also easily access advanced settings, such as changing the paper type and size, adjusting the darkness of the copy, and resizing the copy.

## Make a 1-sided copy

1. Load the original print side up into the document feeder, or load the original print side down on the right front corner of the scanner glass.
2. Specify number of copies and settings.
  - From the Home screen, touch **Copy**. Flick to the desired number of copies.
  - If the value for the **2-Sided** option is **1:2**, touch to select **1:1**.
  - Touch  (**Settings**) to specify paper size, paper type, quality, or other settings.
  - Touch  (**Back**) to return to the Copy screen.
3. Touch **Black** or **Color** to start the copy job.

## Make a 2-sided copy

1. Load the original print side up into the document feeder, or load the original print side down on the right front corner of the scanner glass.
2. Specify number of copies and settings.
  - From the Home screen, touch **Copy**. Flick to the desired number of copies.
  - If the value for the **2-Sided** option is **1:1**, touch to select **1:2**.
  - Touch  (**Settings**), scroll through the options, and then touch **Resize** to make sure **Actual** is selected.



---

**NOTE:** The 2-sided function does not work if the **Fit to Page** option is selected.

---

- From the **Settings** screen, specify paper size, paper type, quality, or other settings.
  - Touch  (**Back**) to return to the Copy screen.
3. Touch **Black** or **Color** to start the copy job.
  4. When prompted, load the second original and touch **OK**.

# Scan

You can scan documents, photos, and other paper types, and send them to a variety of destinations, such as a computer or an email recipient.

When scanning documents with the HP printer software, you can scan to a format that can be searched and edited.

When scanning a borderless original, use the scanner glass and not the document feeder.



**NOTE:** Some scan functions are only available after you have installed the HP printer software.

---

[Click here to go online for more information.](#)

- [Scan to a computer](#)
- [Scan to a memory device](#)
- [Scan to Email](#)
- [Scan using Webscan](#)

## Scan to a computer

Before scanning to a computer, make sure you have already installed the HP recommended printer software. The printer and computer must be connected and turned on.

In addition, on Windows computers, the printer software must be running prior to scanning.

### To enable the scan to a computer feature (Windows)

The scan to a computer feature is enabled by default from the factory. Follow these instructions if the feature has been disabled, and you wish to enable it again.

1. Open the HP printer software.
2. Go to the **Scan** section.
3. Select **Manage Scan to Computer**.
4. Click **Enable**.

### To enable the scan to a computer feature (OS X)

The scan to a computer feature is enabled by default from the factory. Follow these instructions if the feature has been disabled, and you wish to enable it again.

1. Open HP Utility.
2. Under **Scan Settings**, click **Scan to Computer**.
3. Ensure that **Enable Scan to Computer** is selected.

### To scan an original from the printer control panel

1. Load the original print side up into the document feeder, or load the original print side down on the right front corner of the scanner glass.
2. Touch **Scan**, and then select **Computer**.

3. Touch a computer that you want to scan to.
4. Choose the type of scan shortcut you want.
5. Touch **Start Scan**.

#### To scan an original from HP printer software (Windows)

1. Load the original print side up into the document feeder, or load the original print side down on the right front corner of the scanner glass.
2. Click the **Print, Scan & Fax** tab.
3. In the **Scan** area, click **Scan a Document or Photo**.
4. Select the type of scan that you want from the shortcut menu and then click **Scan**.



**NOTE:** If **Show Scan Preview** is selected, you can make adjustments to the scanned image in the preview screen.

5. Select **Save** if you want to keep the application open for another scan, or select **Done** to exit the application.
6. Click **Scan**.

After the scan is saved, Windows Explorer opens the directory with the saved scan.

#### To scan an original from HP printer software (OS X)

1. Open HP Scan.  
HP Scan is located in the **Applications/Hewlett-Packard** folder at the top level of the hard disk.
2. Choose the type of scan profile you want and follow the on-screen instructions.

## Scan to a memory device

#### To scan an original to a memory device from the printer control panel

1. Load the original print side up into the document feeder, or load the original print side down on the right front corner of the scanner glass.
2. Insert a memory device.



3. Touch **Scan**, and then select **Memory Device**.
4. Make changes to scan options, if needed.
5. Touch **Start Scan**.



## Scan to Email

The Scan-to-Email App is an application that allows you to quickly scan and email photos or documents to the specified recipients directly from your HP e-All-in-One printer. You can set up your email addresses, log in to your accounts with the given PIN codes, and then scan and email your documents.

This section contains the following topics:

- [Set up Scan to Email](#)
- [Use Scan to Email](#)
- [Change account settings](#)

### Set up Scan to Email

#### To set up Scan to Email

1. Touch **Scan**, and then touch **Email**.
2. On the **Welcome** screen, touch **Continue**.
3. Touch in the **Email:** box to enter your email address, and then touch **Done**.
4. Touch **Continue**.
5. A PIN will be sent to the email address you entered. Touch **Continue**.
6. Touch the **PIN** to enter your PIN and then touch **Done**.
7. Touch **Store Email** or **Auto-login**, depending upon how you want the printer to store your login information.
8. Select your scan type by touching **Photo** or **Document**.
9. For photos, select the can settings, and touch **Continue**.  
For documents, continue with the next step.
10. Verify the email information, and touch **Continue**.
11. Touch **Scan to Email**.
12. Touch **OK** when the scan completes, and then touch **Yes** to send another email, or **No** to finish.

### Use Scan to Email

#### To use Scan to Email

1. Load the original print side up into the document feeder, or load the original print side down on the right front corner of the scanner glass.
2. Touch **Scan**, and then touch **Email**.
3. On the control panel display, select the account that you want to use, and touch **Continue**.



**NOTE:** Select **My account is not listed** if you do not have an account. You will be prompted to enter your email address and receive a PIN.

4. If prompted, enter the PIN.
5. Select your scan type by touching **Photo** or **Document**.
6. For photos, select the scan settings, and touch **Continue**.  
For documents, continue with the next step.
7. To add or remove recipients, touch **Modify Recipient(s)**, and when finished touch **Done**.
8. Verify the email information and touch **Continue**.
9. Touch **Scan to Email**.
10. Touch **OK** when the scan completes, and then touch **Yes** to send another email, or **No** to finish.

## Change account settings

### To change account settings

1. Touch **Scan**, and then touch **Email**.
2. On the control panel display, select the account that you want to change, and touch **Modify**.
3. Select which setting you want to modify, and follow the onscreen prompts.
  - Auto-login
  - Store Email
  - Remove from list
  - Change PIN
  - Delete Account

## Scan using Webscan

Webscan is a feature of the embedded web server that lets you scan photos and documents from your printer to your computer using a web browser.

This feature is available even if you did not install the printer software on your computer.



**NOTE:** By default, Webscan is off. You can enable this feature from the EWS.

If you are unable to open Webscan in the EWS, your network administrator might have turned it off. For more information, contact your network administrator or the person who set up your network.

### To enable Webscan

1. Open the embedded web server. For more information, see [Open the embedded Web server on page 93](#).
2. Click the **Settings** tab.
3. In the **Security** section, click **Administrator Settings**.
4. Select **Webscan** to enable Webscan.
5. Click **Apply** and then click **OK**.

## To scan using Webscan

Scanning using Webscan offers basic scan options. For additional scan options or functionality, scan from the HP printer software.

1. Load the original print side up into the document feeder, or load the original print side down on the right front corner of the scanner glass.
2. Open the embedded web server. For more information, see [Open the embedded Web server on page 93](#).
3. Click the **Scan** tab.
4. Click **Webscan** in the left pane, change any settings, and then click **Start Scan**.

## Tips for copy and scan success

Use the following tips to copy and scan successfully:

- Keep the glass and the back of the lid clean. The scanner interprets anything it detects on the glass as part of the image.
- Load your original, print side down, on the right front corner of the glass.
- To make a large copy of a small original, scan the original into the computer, resize the image in the scanning software, and then print a copy of the enlarged image.
- If you want to adjust scan size, output type, scan resolution, or file type, and so on, start scan from the printer software.
- To avoid incorrect or missing scanned text, make sure the brightness is set appropriately in the software.
- If you want to scan a document with several pages into one file instead of multiple files, start the scan with the printer software instead of selecting **Scan** from the printer display.

---

# 5 Use Web Services

- [What are Web Services?](#)
- [Set up Web Services](#)
- [Print with HP ePrint](#)
- [Use HP Printables](#)
- [Use the HP Connected website](#)
- [Remove Web Services](#)
- [Tips for using Web Services](#)

# What are Web Services?

## ePrint

- **ePrint** is a free service from HP that allows you to print to your HP ePrint-enabled printer anytime, from any location. It's as simple as sending an email to the email address assigned to your printer when you enable Web Services on the printer. No special drivers or software are needed. If you can send an email, you can print from anywhere, using **ePrint**.

Once you have signed up for an account on HP Connected ([www.hpconnected.com](http://www.hpconnected.com)), you can sign in to view your **ePrint** job status, manage your **ePrint** printer queue, control who can use your printer's **ePrint** email address to print, and get help for **ePrint**.

## HP Printables

- HP Printables allow you to easily locate and print preformatted web content, directly from your printer. You can also scan and store your documents digitally on the Web.

HP Printables provide a wide range of content, from store coupons to family activities, news, travel, sports, cooking, photos, and many more. You can even view and print your online images from popular photo sites.

Certain HP Printables also allow you to schedule the delivery of app content to your printer.

Preformatted content designed specifically for your printer means no cut-off text and pictures and no extra pages with only one line of text. On some printers, you can also choose paper and print quality settings on the print preview screen.

# Set up Web Services

Before you set up Web Services, make sure your printer is connected to the Internet using either an Ethernet or wireless connection.

To set up Web Services, use one of the following methods.

## To set up Web Services using the printer control panel

1. From the printer control panel display, touch **Setup**.
2. Touch **Web Services Setup**.
3. Touch **Accept** to accept the Web Services terms of use and enable Web Services.
4. In the **Auto Update** screen, touch **Yes** to allow the printer to automatically check for and install product updates.

---

 **NOTE:** If a printer update is available, the printer will download and install the update, and then restart. You will have to repeat the instructions from step 1 to set up **ePrint**.

 **NOTE:** If prompted for proxy settings and if your network uses proxy settings, follow the on-screen instructions to set up a proxy server. If you do not have the proxy details, contact your network administrator or the person who set up the network.

---

5. When the printer is connected to the server, the printer prints an information page. Follow the instructions on the information page to finish the setup.

## To set up Web Services using the embedded web server

1. Open the EWS. For more information, see [Open the embedded Web server on page 93](#).
2. Click the **Web Services** tab.
3. In the **Web Services Settings** section, click **Setup**, click **Continue**, and follow the on-screen instructions to accept the terms of use.
4. If prompted, choose to allow the printer to check for and install printer updates.

---

 **NOTE:** If a printer update is available, the printer downloads and installs the update, and then restarts. Repeat the instructions from step 1 to set up **ePrint**.

 **NOTE:** If prompted for proxy settings and if your network uses proxy settings, follow the on-screen instructions to set up a proxy server. If you do not have the proxy details, contact your network administrator or the person who set up the network.

---

5. When the printer is connected to the server, the printer prints an information page. Follow the instructions on the information page to finish the setup.

## To set up Web Services using the HP printer software (Windows)

1. Open the HP printer software. For more information, see [Open the HP printer software \(Windows\) on page 18](#).
2. In the window that appears, double-click **Print, Scan & Fax** and then select **Connect Printer to the Web** under Print. The printer's home page (embedded web server) opens.
3. Click the **Web Services** tab.

4. In the **Web Services Settings** section, click **Setup**, click **Continue**, and follow the on-screen instructions to accept the terms of use.
5. If prompted, choose to allow the printer to check for and install printer updates.

---

 **NOTE:** If a printer update is available, the printer will download and install the update, and then restart. You will have to repeat the instructions from step 1 to set up **ePrint**.

 **NOTE:** If prompted for proxy settings and if your network uses proxy settings, follow the on-screen instructions to set up a proxy server. If you do not have the details, contact your network administrator or the person who set up the network.

---

6. When the printer is connected to the server, the printer prints an information page. Follow the instructions on the information page to finish the setup.



# Print with HP ePrint

HP ePrint is a free service from HP that allows you to print to your HP ePrint-enabled printer anywhere you can send an email. Just send your documents and photos to the email address assigned to your printer when you enable Web Services. No additional drivers or software are needed.

- Your printer needs to have a wireless network connection to the Internet. You will not be able to use HP ePrint via a USB connection to a computer.
- Attachments might print differently from the way they appear in the software program that created them, depending on the original fonts and layout options used.
- Free product updates are provided with HP ePrint. Some updates might be required to enable certain functionality.

Once you have signed up for an account on HP Connected ([www.hpconnected.com](http://www.hpconnected.com)), you can sign in to view your ePrint job status, manage your ePrint printer queue, control who can use your printer's ePrint email address to print, and get help for ePrint.

Before you can use ePrint, make sure that:

- The printer is connected to an active network providing Internet access.
- Web Services is turned on. If not, you will be prompted to turn it on.

## To ePrint a document from anywhere

1. Enable Web Services.
  - a. From the Home screen, touch the  (ePrint) icon.
  - b. Accept the Terms of Use, and then follow the onscreen instructions to enable Web Services.
  - c. Print the ePrint information page, and then follow the instructions on the page to sign up for an ePrint account.
2. Find your ePrint email address.
  - a. Touch the **ePrint** icon on the Home screen. You will see the **Web Services Settings** menu on the printer display.
  - b. The printer's email address appears in the **Web Services Settings** menu.
3. Email your document to the printer for printing.
  - a. Create a new email and attach the document to print.
  - b. Send the email to the printer email address.

The printer prints the attached document.

---

 **NOTE:** The **ePrint** server does not accept email print jobs if there are multiple email addresses included in the "To" or "Cc" fields. Only enter the HP ePrint email address in the "To" field. Do not enter any additional email addresses in the other fields.

---

---

 **NOTE:** The email will be printed once it is received. As with any email, there is no guarantee when or whether it will be received. You can check the print status on HP Connected ([www.hpconnected.com](http://www.hpconnected.com)).

 **NOTE:** Documents printed with **ePrint** may appear different from the original. Style, formatting, and text flow may differ from the original document. For documents that need to be printed with a higher quality (such as legal documents), we recommend that you print from the software application on your computer, where you will have more control over what your printout looks like.

---



[Click here to go online for more information.](#)

## Use HP Printables

Print pages from the web, without using a computer, by setting up HP Printables, a free service from HP. You can print coloring pages, calendars, puzzles, recipes, maps, and more, depending on the apps available in your country/region.

Touch the **Get More** icon on the HP Printables screen to connect to the Internet and add more apps. You need to have Web Services enabled in order to use apps.

Go to the HP Connected website for more information and specific terms and conditions:  
[www.hpconnected.com](http://www.hpconnected.com).



## Use the HP Connected website

Use HP's free HP Connected website to set up increased security for HP ePrint, and specify the email addresses that are allowed to send email to your printer. You can also get product updates, more apps, and other free services.

Go to the HP Connected website for more information and specific terms and conditions:  
[www.hpconnected.com](http://www.hpconnected.com).

# Remove Web Services

## To remove Web Services

1. From the printer control panel display, touch  (ePrint), and then touch  (Web Services Settings).
2. Touch **Remove Web Services**.

# Tips for using Web Services

Use the following tips to print apps and use HP ePrint.

## Tips for printing apps and using HP ePrint

- Learn how to share your photos online and order prints. [Click here to go online for more information.](#)
- Learn about apps for printing recipes, coupons, and other content from the web, simply and easily. [Click here to go online for more information.](#)

---

## 6 Fax

You can use the printer to send and receive faxes, including color faxes. You can schedule faxes to be sent at a later time and set up phone book contacts to send faxes quickly and easily to frequently used numbers. From the printer control panel, you can also set a number of fax options, such as resolution and the contrast between lightness and darkness on the faxes you send.

 **NOTE:** Before you begin faxing, make sure you have set up the printer correctly for faxing. You can verify the fax is set up correctly by running the fax setup test from the printer control panel.

Learn more about fax setup and test, [click here to go online for more information](#).

- [Send a fax](#)
- [Receive a fax](#)
- [Set up phone book contacts](#)
- [Change fax settings](#)
- [Fax and digital phone services](#)
- [Fax over Internet Protocol](#)
- [Use reports](#)

# Send a fax

You can send a fax in a variety of ways, depending on your situation or need.

- [Send a standard fax](#)
- [Send a standard fax from the computer](#)
- [Send a fax from a phone](#)
- [Send a fax using monitor dialing](#)
- [Send a fax from memory](#)
- [Send a fax to multiple recipients](#)
- [Send a fax in Error Correction Mode](#)

## Send a standard fax

You can easily send a single- or multiple-page black-and-white or color fax by using the printer control panel.



---

**NOTE:** If you need printed confirmation that your faxes were successfully sent, fax confirmation must be enabled.

---

### To send a standard fax from the printer control panel

1. Load the original print side up into the document feeder, or load the original print side down on the right front corner of the scanner glass.
2. From the printer control panel display, touch **Fax**.
3. Touch **Send Now**.
4. Enter the fax number by using the keypad.



---

**TIP:** To add a pause in the fax number you are entering, touch \* repeatedly, until a dash (-) appears on the display.

---

5. Touch **Black** or **Color**.

If the printer detects an original loaded in the document feeder, it sends the document to the number you entered.



---

**TIP:** If the recipient reports issues with the quality of the fax, try changing the resolution or contrast of your fax.

---

## Send a standard fax from the computer

You can fax a document directly from your computer without printing it first.

To use this feature, make sure you have installed the HP printer software on your computer, the printer is connected to a working telephone line, and the fax function is set up and functioning correctly.



### To send a standard fax from the computer (Windows)

1. Open the document on your computer that you want to fax.
2. On the **File** menu in your software application, click **Print**.
3. From the **Name** list, select the printer that has “**fax**” in the name.
4. To change settings (such as selecting to send the document as a black fax or a color fax), click the button that opens the **Properties** dialog box. Depending on your software application, this button might be called **Properties**, **Options**, **Printer Setup**, **Printer**, or **Preferences**.
5. After you have changed any settings, click **OK**.
6. Click **Print** or **OK**.
7. Enter the fax number and other information for the recipient, change any further settings for the fax, and then click **Send Fax**. The printer begins dialing the fax number and faxing the document.

### To send a standard fax from the computer (OS X)

1. Open the document on your computer that you want to fax.
2. From the **File** menu in your software, click **Print**.
3. Select the printer that has “**(Fax)**” in the name.
4. Enter a fax number or a name from your Contacts that already has a fax number entry.
5. When you have finished filling out the fax information, click **Fax**.

## Send a fax from a phone

You can send a fax using your telephone extension. This allows you to talk with the intended recipient before sending the fax.

### To send a fax from an extension phone

1. Load the original print side up into the document feeder, or load the original print side down on the right front corner of the scanner glass.
2. Dial the number by using the keypad on the phone that is connected to the printer.  
  
If the recipient answers the telephone, inform the recipient that they should receive the fax on their fax machine after they hear fax tones. If a fax machine answers the call, you will hear fax tones from the receiving fax machine.
3. From the printer control panel display, touch **Fax**.
4. Touch **Send Fax**.
5. When you are ready to send the fax, touch **Black** or **Color**.

The telephone is silent while the fax is transmitting. If you want to speak to the recipient after, remain on the line until the transmission is complete. If you were finished talking to the recipient, you can hang up the telephone as soon as the fax begins transmitting.

## Send a fax using monitor dialing

When you send a fax using monitor dialing, you can hear the dial tones, telephone prompts, or other sounds through the speakers on the printer. This enables you to respond to prompts while dialing, as well as control the pace of your dialing.

---

 **TIP:** If you are using a calling card and do not enter your PIN fast enough, the printer might start sending fax tones too soon and cause your PIN not to be recognized by the calling card service. If this is the case, you can create a phone book contact to store the PIN for your calling card. For more information, see [Set up phone book contacts on page 61](#).



 **NOTE:** Make sure the volume is turned on to hear a dial tone.

---

### To send a fax using monitor dialing from the printer control panel

1. Load the original print side up into the document feeder, or load the original print side down on the right front corner of the scanner glass.
2. From the printer control panel display, touch **Fax**.
3. Touch **Send Now**.
4. Touch **Black** or **Color**.
5. When you hear the dial tone, enter the number by using the keypad on the printer control panel.
6. Follow any prompts that might occur.

---

 **TIP:** If you are using a calling card to send a fax and you have your calling card PIN stored as a phone book contact, when prompted to enter your PIN, touch  (Phone book) to select the phone book contact where you have your PIN stored.

---

Your fax is sent when the receiving fax machine answers.

## Send a fax from memory

You can scan a black-and-white fax into memory and then send the fax from memory. This feature is useful if the fax number you are trying to reach is busy or temporarily unavailable. The printer scans the originals into memory and sends them once it is able to connect to the receiving fax machine. After the printer scans the pages into memory, you can immediately remove the originals from the document feeder tray or scanner glass.

---

 **NOTE:** You can only send a black-and-white fax from memory.

---

### To send a fax from memory

1. Ensure that **Scan and Fax Method** is turned on.
  - a. From the printer control panel display, touch **Setup**.
  - b. Touch **Fax Setup**, and then touch **Preferences**.
  - c. Set **Scan and Fax Method** to on.
2. Load the original print side up into the document feeder, or load the original print side down on the right front corner of the scanner glass.



3. From the printer control panel display, touch **Fax**.
4. Touch **Send Now**.
5. Enter the fax number by using the keypad, touch  (Phone book) to select a phone book contact or to select a previously dialed or received number.
6. Touch **Black**.

The printer sends the fax when the receiving fax machine is available.

## Send a fax to multiple recipients

You can send a fax to multiple recipients by creating a group phone book contact made up of two or more individual recipients.

### To send a fax to multiple recipients using group phone book

1. Load the original print side up into the document feeder, or load the original print side down on the right front corner of the scanner glass.
2. From the printer control panel display, touch **Fax**.
3. Touch **Send Now**.
4. Touch  (Phone book).
5. Touch  (**Group Phone Book Contact**).
6. Touch the name of the group phone book contact.
7. Touch **Send Fax**.

If the printer detects an original loaded in the document feeder, it sends the document to each number in the Group Phone Book contact.

---

 **TIP:** If the recipient reports issues with the quality of the fax, try changing the resolution or contrast of your fax.

---

## Send a fax in Error Correction Mode

**Error Correction Mode** (ECM) prevents loss of data due to poor phone lines by detecting errors that occur during transmission and automatically requesting retransmission of the erroneous portion. Phone charges are unaffected, or might even be reduced, on good phone lines. On poor phone lines, ECM increases sending time and phone charges, but sends the data much more reliably. The default setting is **On**. Turn ECM off only if it increases phone charges substantially, and if you can accept poorer quality in exchange for reduced charges.

If you turn ECM off:

- The quality and transmission speed of faxes you send and receive are affected.
- The **Fax Speed** is automatically set to **Medium**.
- You can no longer send or receive faxes in color.

### To change the ECM setting from the control panel

1. From the printer control panel display, touch **Setup**.
2. Touch **Fax Setup**.
3. Touch **Preferences**.
4. Scroll to **Error Correction Mode** and touch to turn the feature on or off.

# Receive a fax

You can receive faxes automatically or manually. If you turn off the **Auto Answer** option, you must receive faxes manually. If you turn on the **Auto Answer** option (the default setting), the printer automatically answers incoming calls and receives faxes after the number of rings that are specified by the **Rings to Answer** setting. (The default **Rings to Answer** setting is five rings.)

If you receive a Legal-size or larger fax and the printer is not currently set to use Legal-size paper, the printer reduces the fax so that it fits on the paper that is loaded. If you have disabled the **Automatic Reduction** feature, the printer prints the fax on two pages.

---

 **NOTE:** If you are copying a document when a fax arrives, the fax is stored in the printer memory until the copying finishes.

---

- [Receive a fax manually](#)
- [Set up backup fax](#)
- [Reprint received faxes from memory](#)
- [Forward faxes to another number](#)
- [Set automatic reduction for incoming faxes](#)
- [Block unwanted fax numbers](#)
- [Receive faxes using HP Digital Fax](#)

## Receive a fax manually

When you are on the phone, the person you are speaking with can send you a fax while you are still connected. You can pick up the handset to talk or listen for fax tones.

You can receive faxes manually from a phone that is directly connected to the printer (on the 2-EXT port).

### To receive a fax manually

1. Make sure the printer is turned on and you have paper loaded in the main tray.
2. Remove any originals from the document feeder tray.
3. Set the **Rings to Answer** setting to a high number to allow you to answer the incoming call before the printer answers. Or, turn off the **Auto Answer** setting so that the printer does not automatically answer incoming calls.
4. If you are currently on the phone with the sender, instruct the sender to press **Start** on their fax machine.
5. When you hear fax tones from a sending fax machine, do the following:
  - a. From the printer control panel display, touch **Fax**, touch **Send and Receive**, and then touch **Receive Now**.
  - b. After the printer begins to receive the fax, you can hang up the phone or remain on the line. The phone line is silent during fax transmission.

## Set up backup fax

Depending on your preference and security requirements, you can set up the printer to store all the faxes it receives, only the faxes it receives while the printer is in an error condition, or none of the faxes it receives.

### To set backup fax from the printer control panel

1. From the printer control panel display, touch **Setup**.
2. Touch **Fax Setup**.
3. Touch **Preferences**.
4. Touch **Backup Fax Reception**.
5. Touch the required setting.

---

<b>On</b>	The default setting. When <b>Backup fax</b> is <b>On</b> , the printer stores all received faxes in memory. This enables you to reprint up to 30 of the most recently printed faxes if they are still saved in memory.  <b>NOTE:</b> When printer memory is low, it overwrites the oldest, printed faxes as it receives new faxes. If the memory becomes full of unprinted faxes, the printer stops answering incoming fax calls.  <b>NOTE:</b> If you receive a fax that is too large, such as a very detailed color photo, it might not be stored in memory due to memory limitations.
<b>On Error Only</b>	Causes the printer to store faxes in memory only if an error condition exists that prevents the printer from printing the faxes (for example, if the printer runs out of paper). The printer continues to store incoming faxes as long as there is memory available. (If the memory becomes full, the printer stops answering incoming fax calls.) When the error condition is resolved, the faxes stored in memory print automatically, and then they are deleted from memory.
<b>Off</b>	Faxes are never stored in memory. For example, you might want to turn off <b>Backup fax</b> for security purposes. If an error condition occurs that prevents the printer from printing (for example, the printer runs out of paper), the printer stops answering incoming fax calls.

---

## Reprint received faxes from memory

The received faxes that are not printed out are stored in memory.



**NOTE:** After the memory becomes full, the printer cannot receive the new fax until you print or delete the faxes from memory. You might also want to delete the faxes in memory for security or privacy purposes.

Depending on the sizes of the faxes in memory, you can reprint up to 30 of the most recently printed faxes, if they are still in memory. For example, you might need to reprint your faxes if you lost the copy of your last printout.

### To reprint faxes in memory from the printer control panel

1. Load paper in the main paper tray.
2. From the printer control panel display, touch **Fax**.

3. Touch **Reprint** and then touch **Print All**.

The faxes are printed in the reverse order from which they were received with the most recently received fax printed first, and so on.

4. If you want to stop reprinting the faxes in memory, touch (Cancel).

## Forward faxes to another number

You can set up the printer to forward your faxes to another fax number. All faxes are forwarded in black and white, regardless of how they were originally sent.

HP recommends that you verify the number you are forwarding to is a working fax line. Send a test fax to make sure the fax machine is able to receive your forwarded faxes.

### To forward faxes from the printer control panel

1. From the printer control panel display, touch **Setup**.
2. Touch **Fax Setup**.
3. Touch **Preferences**.
4. Touch **Fax Forwarding**.
5. Touch **On (Print and Forward)** to print and forward the fax, or select **On (Forward)** to forward the fax.

---

 **NOTE:** If the printer is not able to forward the fax to the designated fax machine (for example, if it is not turned on), the printer prints the fax. If you set up the printer to print error reports for received faxes, it also prints an error report.

---

6. At the prompt, enter the number of the fax machine intended to receive the forwarded faxes, and then touch **Done**. Enter the required information for each of the following prompts: start date, start time, end date, and end time.
7. Fax forwarding is activated. Touch **OK** to confirm.

If the printer loses power when fax forwarding is set up, it saves the fax forwarding setting and phone number. When the power is restored to the printer, the fax forwarding setting is still **On**.

---

 **NOTE:** You can cancel fax forwarding by selecting **Off** from the **Fax Forwarding** menu.

---

## Set automatic reduction for incoming faxes

The **Automatic Reduction** setting determines what the printer does if it receives a fax that is too large for the loaded paper size. This setting is turned on by default, so the image of the incoming fax is reduced to fit on one page, if possible. If this feature is turned off, information that does not fit on the first page is printed on a second page. **Automatic Reduction** is useful when you receive a Legal-size fax and Letter-size paper is loaded in the main tray.

### To set automatic reduction from the printer control panel

1. From the printer control panel display, touch **Setup**.
2. Touch **Fax Setup**.

3. Touch **Preferences**.
4. Touch **Automatic Reduction** to turn on or off.

## Block unwanted fax numbers

If you subscribe to a caller ID service through your phone provider, you can block specific fax numbers so the printer does not receive faxes received from those numbers. When an incoming fax call is received, the printer compares the number to the list of junk fax numbers to determine if the call should be blocked. If the number matches a number in the blocked fax numbers list, the fax is not received. (The maximum number of fax numbers you can block varies by model.)

---

 **NOTE:** This feature is not supported in all countries/regions. If it is not supported in your country/region, **Junk Fax Blocking** does not appear in the **Preferences** menu.

 **NOTE:** If no phone numbers are added in the Caller ID list, it is assumed that you are not subscribed to a Caller ID service.

---

You can block specific fax numbers by adding them to the junk fax list, unblock these numbers by removing them from the junk fax list, and print a list of blocked junk fax numbers.

### To add a number to the junk fax list

1. From the printer control panel display, touch **Setup**.
2. Touch **Fax Setup**.
3. Touch **Preferences**.
4. Touch **Junk Fax Blocking**.
5. Touch **+** (Plus Sign).
6. Do one of the following.
  - To select a fax number to block from the call history list, touch  (Received Call History).
  - Manually enter a fax number to block, and touch **Add**.

---

 **NOTE:** Make sure you enter the fax number as it appears on the control panel display, and not the fax number that appears on the fax header of the received fax, as these numbers can be different.

---

### To remove numbers from the junk fax list

If you no longer want to block a fax number, you can remove it from the junk fax list.

1. From the printer control panel display, touch **Setup**.
2. Touch **Fax Setup**.
3. Touch **Preferences**.
4. Touch **Junk Fax Blocking**.
5. Touch the number you want to remove, and then touch **Remove**.



## To print a junk fax list

1. From the printer control panel display, touch **Setup**.
2. Touch **Fax Setup**, and then touch **Reports**.
3. Touch **Print Fax Reports**.
4. Touch **Junk Fax Report**.
5. Touch **Print** to begin printing.

## Receive faxes using HP Digital Fax

You can use HP Digital Fax to automatically receive faxes and save them directly to your computer. This saves paper and ink.

Received faxes are saved as TIFF (Tagged Image File Format) or PDF (Portable Document Format).

The files are named in the following method: XXXX\_YYYYYYYY\_ZZZZZZ.tif, where X is the sender's information, Y is the date, and Z is the time that the fax was received.



---

**NOTE:** Fax to Computer is available for receiving black-and-white faxes only. Color faxes will be printed.

---

- [HP Digital Fax requirements](#)
- [Activate HP Digital Fax](#)
- [Modify HP Digital Fax settings](#)

## HP Digital Fax requirements

- The destination folder of the computer must be available at all times. The destination computer must also be awake, faxes will not be saved if the computer is asleep or in hibernate mode.
- Paper must be loaded in the input tray.

## Activate HP Digital Fax

### To set up HP Digital Fax (Windows)

1. Open the HP printer software. For more information, see [Open the HP printer software \(Windows\) on page 18](#).
2. Click **Print, Scan & Fax** and click **Digital Fax Setup Wizard**.
3. Follow the on-screen instructions.

### To set up HP Digital Fax (OS X)

1. Open HP Utility.  
HP Utility is located in the **Hewlett-Packard** folder in the **Applications** folder at the top level of the hard disk.
2. Select the printer.
3. Click **Digital Fax Archive** in the Fax Settings section.

## Modify HP Digital Fax settings

You can turn off HP Digital Fax and disable printing faxes from the printer control panel.

### To modify settings from the printer control panel

1. From the printer control panel display, touch **Setup**.
2. Touch **Fax Setup**.
3. Touch **Preferences**, and then touch **HP Digital Fax**.
4. Select the setting that you want to change. You can change the following settings:
  - **Fax Printing:** Choose this option to print faxes as they are received. If you turn off printing, color faxes will still print.
  - **Turn Off HP Digital Fax:** Choose this option to turn off HP Digital Fax.



---

**NOTE:** Use the HP printer software on your computer to turn on HP Digital Fax.

---

### To modify settings from the HP printer software (Windows)

1. Open the HP printer software. For more information, see [Open the HP printer software \(Windows\) on page 18](#).
2. Click **Print, Scan & Fax** and click **Digital Fax Setup Wizard**.
3. Follow the on-screen instructions.

### To modify settings from the HP printer software (OS X)

1. Open HP Utility.  
HP Utility is located in the **Hewlett-Packard** folder in the **Applications** folder at the top level of the hard disk.
2. Select the printer.
3. Click **Digital Fax Archive** in the Fax Settings section.

### Turn off HP Digital Fax

1. From the printer control panel display, touch **Setup**.
2. Touch **Fax Setup**.
3. Touch **Preferences** and then touch **HP Digital Fax**.
4. Touch **Turn Off HP Digital Fax**.
5. Touch **Yes**.

# Set up phone book contacts

You can set up frequently used fax numbers as phone book contacts. This lets you quickly dial those numbers using the printer control panel.



 **TIP:** In addition to creating and managing phone book contacts from the printer control panel, you can also use tools available on your computer, such as the HP software included with the printer and the printer EWS. For more information, see [Advanced printer management tools \(for networked printers\) on page 92](#).

- [Set up and change phone book contacts](#)
- [Set up and change group phone book contacts](#)
- [Delete phone book contacts](#)
- [Print a list of phone book contacts](#)

## Set up and change phone book contacts

You can store fax numbers as phone book contacts.



### To set up phone book contacts

1. From the printer control panel display, touch **Fax**.
2. Touch **Send Now**.
3. Touch  (Phone book).
4. Touch  (**Phone Book Contact**).
5. Touch  (**Plus Sign**) to add a contact.
6. Touch **Name** and then type the name of the phone book contact, and then touch **Done**.
7. Touch **Fax Number** and type the fax number for the phone book contact, and then touch **Done**.

 **NOTE:** Be sure to include any pauses or other required numbers, such as an area code, an access code for numbers outside a PBX system (usually a 9 or 0), or a long-distance prefix.

8. Touch **Add**.

### To change phone book contacts

1. From the printer control panel display, touch **Fax**.
2. Touch **Send Now**.
3. Touch  (Phone book).
4. Touch  (**Phone Book Contact**).
5. Touch  (**Edit**) to edit a contact.
6. Touch the phone book contact that you want to edit.
7. Touch **Name** and then edit the name of the Phone Book contact, and then touch **Done**.

8. Touch **Fax Number** and edit the fax number for the phone book contact, and then touch **Done**.

---

 **NOTE:** Be sure to include any pauses or other required numbers, such as an area code, an access code for numbers outside a PBX system (usually a 9 or 0), or a long-distance prefix.

---

9. Touch **Done**.

## Set up and change group phone book contacts



You can store groups of fax numbers as group phone book contacts.

### To set up group phone book contacts



---

 **NOTE:** Before you can create a group phone book contact, you must have already created at least one phone book contact.

---



1. From the printer control panel display, touch **Fax**.
2. Touch **Send Now**.
3. Touch  (Phone book).
4. Touch  (Group Phone Book Contact).
5. Touch **+** (**Plus Sign**) to add a group.
6. Touch **Name** and then type the name of the group, and then touch **Done**.
7. Touch **Number of Members**, select the phone book contacts you want to include in this group, and then touch **Select**.
8. Touch **Create**.

### To change group phone book contacts

1. From the printer control panel display, touch **Fax**.
2. Touch **Send Now**.
3. Touch  (Phone book).
4. Touch  (Group Phone Book Contact).
5. Touch  (**Edit**) to edit a group.
6. Touch the group phone book contact that you want to edit.
7. Touch **Name** and then edit the name of the group phone book contact, and then touch **Done**.
8. Touch **Number of Members**.
9. Deselect the phone book contacts you want to delete from this group, or touch **+** (**Plus Sign**) to add a contact to the group.
10. Touch **Done**.

## Delete phone book contacts

You can delete phone book contacts or group phone book contacts.

1. From the printer control panel display, touch **Fax**.
2. Touch **Send Now**.
3. Touch  (Phone book).
4. Touch  (Phone Book Contact).
5. Touch  (Edit).
6. Touch the name of the phone book contact you want to delete.
7. Touch **Delete**.
8. Touch **Yes** to confirm.

## Print a list of phone book contacts

You can print a list of your phone book contacts.

1. Load paper in the main paper tray.
2. From the printer control panel, touch **Setup**.
3. Touch **Fax Setup**, and then touch **Reports**.
4. Touch **Print Phone Book**.

## Change fax settings

After completing the steps in the getting started guide that came with the printer, use the following steps to change the initial settings or to configure other options for faxing.

- [Configure the fax header](#)
- [Set the answer mode \(Auto answer\)](#)
- [Set the number of rings before answering](#)
- [Change the answer ring pattern for distinctive ring](#)
- [Set the dial type](#)
- [Set the redial options](#)
- [Set the fax speed](#)
- [Set the fax sound volume](#)

### Configure the fax header

The fax header prints your name and fax number on the top of every fax you send. HP recommends that you set up the fax header by using the HP software provided with the printer. You can also set up the fax header from the printer control panel, as described here.



---

**NOTE:** In some countries/regions, the fax header information is a legal requirement.

---

#### To set or change the fax header

1. From the printer control panel display, touch **Setup**.
2. Touch **Fax Setup**, and then touch **Preferences**.
3. Touch **Fax Header**.
4. Enter your personal or company name, and then touch **Done**.
5. Enter your fax number, and then touch **Done**.

### Set the answer mode (Auto answer)

The answer mode determines whether the printer answers incoming calls.

- Turn on the **Auto Answer** setting if you want the printer to answer faxes **automatically**. The printer answers all incoming calls and faxes.
- Turn off the **Auto Answer** setting if you want to receive faxes **manually**. You must be available to respond in person to the incoming fax call or else the printer does not receive faxes.

#### To set the answer mode

1. From the printer control panel display, touch **Setup**.
2. Touch **Fax Setup**, and then touch **Preferences**.
3. Touch **Auto Answer** to turn it on or off.

You may also access this feature by touching  (the **Fax Status** icon) on the Home screen.

## Set the number of rings before answering

If you turn on the **Auto Answer** setting, you can specify how many rings occur before incoming calls are automatically answered.

The **Rings to Answer** setting is important if you have an answering machine on the same phone line as the printer, because you want the answering machine to answer the phone before the printer does. The number of rings to answer for the printer should be greater than the number of rings to answer for the answering machine.

For example, set your answering machine to a low number of rings and the printer to answer in the maximum number of rings. (The maximum number of rings varies by country/region.) In this setup, the answering machine answers the call and the printer monitors the line. If the printer detects fax tones, it receives the fax. If the call is a voice call, the answering machine records the incoming message.

### To set the number of rings before answering

1. From the printer control panel display, touch **Setup**.
2. Touch **Fax Setup**, and then touch **Preferences**.
3. Touch **Rings to Answer**.
4. Touch the number of rings.
5. Touch **Done** to accept the setting.

## Change the answer ring pattern for distinctive ring

Many phone companies offer a distinctive ring feature that allows you to have several phone numbers on one phone line. When you subscribe to this service, each number is assigned a different ring pattern. You can set up the printer to answer incoming calls that have a specific ring pattern.

If you connect the printer to a line with distinctive ring, have your telephone company assign one ring pattern to voice calls and another ring pattern to fax calls. HP recommends that you request double or triple rings for a fax number. When the printer detects the specified ring pattern, it answers the call and receives the fax.

---

 **TIP:** You can also use the Ring Pattern Detection feature in the printer control panel to set distinctive ring. With this feature, the printer recognizes and records the ring pattern of an incoming call and, based on this call, automatically determines the distinctive ring pattern assigned by your telephone company to fax calls.

---

If you do not have a distinctive ring service, use the default ring pattern, which is **All Rings**.

---

 **NOTE:** The printer cannot receive faxes when the main phone number is off the hook.

---

### To change the answer ring pattern for distinctive ring

1. Verify that the printer is set to answer fax calls automatically.
2. From the printer control panel display, touch **Setup**.
3. Touch **Fax Setup**, and then select **Preferences**.

4. Touch **Distinctive Ring**.
5. A message appears stating that this setting should not be changed unless you have multiple numbers on the same telephone line. Touch **Yes** to continue.
6. Do one of the following:
  - Touch the ring pattern assigned by your telephone company to fax calls.
  - Touch **Ring Pattern Detection**, and then follow the instructions on the printer control panel.

---

 **NOTE:** If the Ring Pattern Detection feature cannot detect the ring pattern or if you cancel the feature before it finishes, the ring pattern is automatically set to the default, which is **All Rings**.

 **NOTE:** If you are using a PBX phone system that has different ring patterns for internal and external calls, you must call the fax number from an external number.

---

## Set the dial type

Use this procedure to set tone-dialing or pulse-dialing mode. The factory-set default is **Tone**. Do not change the setting unless you know that your phone line cannot use tone dialing.

---

 **NOTE:** The pulse-dialing option is not available in all countries/regions.

---

### To set the dial type

1. From the printer control panel display, touch **Setup**.
2. Touch **Fax Setup**, and then touch **Preferences**.
3. Touch **Dial Type**.
4. Touch to select **Tone Dialing** or **Pulse Dialing**.

## Set the redial options

If the printer was unable to send a fax because the receiving fax machine did not answer or was busy, the printer attempts to redial based on the settings for the redial options. Use the following procedure to turn the options on or off.

- **Busy redial:** If this option is turned on, the printer redials automatically if it receives a busy signal. The default is **On**.
- **No answer redial:** If this option is turned on, the printer redials automatically if the receiving fax machine does not answer. The default is **Off**.
- **Connection problem redial:** If this option is turned on, the printer redials automatically if there has been a problem connecting with the receiving fax machine. Connection problem redial works only for sending faxes from memory. The default is **On**.

### To set the redial options

1. From the printer control panel display, touch **Setup**.
2. Touch **Fax Setup**, and then touch **Preferences**.



3. Touch **Auto Redial**.
4. Touch **Busy Redial**, or **No Answer Redial**, or **Connection Problem Redial**, and then select the appropriate options.

## Set the fax speed

You can set the fax speed used to communicate between your printer and other fax machines when sending and receiving faxes.

If you use one of the following, setting the fax speed to a slower speed might be required:

- An Internet phone service
- A PBX (private branch exchange) system
- Fax over Internet Protocol (FoIP)
- An integrated services digital network (ISDN) service

If you experience problems sending and receiving faxes, try using a slower **Fax Speed**. The following table provides the available fax speed settings.

Fax speed setting	Fax speed
Fast	v.34 (33600 baud)
Medium	v.17 (14400 baud)
Slow	v.29 (9600 baud)

### To set the fax speed

1. From the printer control panel display, touch **Setup**.
2. Touch **Fax Setup**, and then touch **Preferences**.
3. Touch **Fax Speed**.
4. Touch to select an option.

## Set the fax sound volume

You can change the volume of fax sounds.

### To set the fax sound volume

1. From the printer control panel display, touch **Setup**.
2. Touch **Fax Setup**, and then touch **Preferences**.
3. Touch **Volume**.
4. Touch to select **Soft**, **Loud**, or **Off**.

## Fax and digital phone services

Many telephone companies provide their customers with digital phone services, such as the following:

- DSL: A Digital subscriber line (DSL) service through your telephone company. (DSL might be called ADSL in your country/region.)
- PBX: A private branch exchange (PBX) phone system.
- ISDN: An integrated services digital network (ISDN) system.
- FoIP: A low-cost phone service that allows you to send and receive faxes with your printer by using the Internet. This method is called Fax over Internet Protocol (FoIP).

For more information, see [Fax over Internet Protocol on page 69](#).

HP printers are designed specifically for use with traditional analog phone services. If you are in a digital phone environment (such as DSL/ADSL, PBX, or ISDN), you might need to use digital-to-analog filters or converters when setting up the printer for faxing.



---

**NOTE:** HP does not guarantee that the printer will be compatible with all digital service lines or providers, in all digital environments, or with all digital-to-analog converters. It is always recommended that you discuss with the telephone company directly for the correct setup options based on their line services provided.

---

# Fax over Internet Protocol

You might be able to subscribe to a low cost phone service that allows you to send and receive faxes with your printer by using the Internet. This method is called Fax over Internet Protocol (FoIP).

You probably use a FoIP service (provided by your telephone company) when you:

- Dial a special access code along with the fax number.
- Have an IP converter box that connects to the Internet and provides analog phone ports for the fax connection.



---

**NOTE:** You can only send and receive faxes by connecting a phone cord to the port labeled "1-LINE" on the printer. This means that your connection to the Internet must be done either through a converter box (which supplies regular analog phone jacks for fax connections) or your telephone company.



**TIP:** Support for traditional fax transmission over any Internet protocol telephone systems are often limited. If you experience problems faxing, try using a slower fax speed or disabling the fax error-correction mode (ECM). However, if you turn off ECM, you cannot send and receive color faxes.

For more information about changing the fax speed, see [Set the fax speed on page 67](#). For more information about using ECM, see [Send a fax in Error Correction Mode on page 53](#).

---

If you have questions about Internet faxing, contact your Internet faxing services support department or your local service provider for further assistance.

## Use reports

You can set up the printer to print error reports and confirmation reports automatically for each fax you send and receive. You can also manually print system reports as required; these reports provide useful system information about the printer.

By default, the printer is set to print a report only if there is a problem sending or receiving a fax. A confirmation message that indicates whether a fax was successfully sent appears briefly on the control panel display after each transaction.

---

 **NOTE:** If the reports are not legible, you can check the estimated ink levels from the control panel or the HP software. For more information, see [Check the estimated ink levels on page 75](#).

 **NOTE:** Ink level alerts and indicators provide estimates for planning purposes only. When you receive a low-ink alert, consider having a replacement cartridge available to avoid possible printing delays. You do not need to replace the ink cartridges until the print quality becomes unacceptable.

 **NOTE:** Ensure that the cartridges are in good conditions and installed properly. For more information, see [Work with cartridges on page 74](#).

---

This section contains the following topics:

- [Print fax confirmation reports](#)
- [Print fax error reports](#)
- [Print and view the fax log](#)
- [Clear the fax log](#)
- [Print the details of the last fax transaction](#)
- [Print a Caller ID Report](#)
- [View the Call History](#)

## Print fax confirmation reports

You can print a confirmation report either when a fax is sent, or when any fax is sent or received. The default setting is **On (Fax Send)**. When turned off, a confirmation message appears briefly on the control panel after each fax is sent or received.

---

 **NOTE:** You can include an image of the first page of the fax on the Fax Sent Confirmation report if you select **On (Fax Send)** or **On (Fax Send and Fax Receive)**, and if you scan the fax to send from memory or use the **Scan and Fax** option.

---

### To enable fax confirmation

1. From the printer control panel display, touch **Setup**.
2. Touch **Fax Setup**.
3. Touch **Reports** and touch **Fax Confirmation**.
4. Touch to select one of the following options.

---

<b>Off</b>	Does not print a fax confirmation report when you send and receive faxes successfully. This is the default setting.
------------	---

---

<b>On (Fax Send)</b>	Prints a fax confirmation report for every fax you send.
<b>On (Fax Receive)</b>	Prints a fax confirmation report for every fax you receive.
<b>On (Fax Send and Fax Receive)</b>	Prints a fax confirmation report for every fax you send and receive.

### To include an image of the fax on the report

1. From the printer control panel display, touch **Setup**.
2. Touch **Fax Setup**.
3. Touch **Reports** and touch **Fax Confirmation**.
4. Touch **On (Fax Send)** or **On (Fax Send and Fax Receive)**.
5. Touch **Fax confirmation with image**.

## Print fax error reports

You can configure the printer so that it automatically prints a report when there is an error during transmission or reception.

### To set the printer to print fax error reports automatically

1. From the printer control panel display, touch **Setup**.
2. Touch **Fax Setup**.
3. Touch **Reports** and touch **Fax Error Report**.
4. Touch to select one of the following.

<b>On (Fax Send and Fax Receive)</b>	Prints whenever a fax error occurs.
<b>Off</b>	Does not print any fax error reports.
<b>On (Fax Send)</b>	Prints whenever a transmission error occurs. This is the default setting.
<b>On (Fax Receive)</b>	Prints whenever a receiving error occurs.

## Print and view the fax log

You can print a log of faxes that have been received and sent by the printer.

### To print the fax log from the printer control panel

1. From the printer control panel display, touch **Setup**.
2. Touch **Fax Setup**, and then touch **Reports**.
3. Touch **Print Fax Reports**.
4. Touch **Last 30 Transactions Fax Logs**.
5. Touch **Print** to begin printing.

## Clear the fax log

Clearing the fax log also deletes all faxes stored in memory.

### To clear the fax log

1. From the printer control panel display, touch **Setup**.
2. Touch **Fax Setup**, and then touch **Tools**.
3. Touch **Clear Fax Log**.

## Print the details of the last fax transaction

The Last Fax Transaction report prints the details of the last fax transaction to occur. Details include the fax number, number of pages, and the fax status.

### To print the Last Fax Transaction report

1. From the printer control panel display, touch **Setup**.
2. Touch **Fax Setup**, and then touch **Reports**.
3. Touch **Print Fax Reports**.
4. Touch **Last Transaction**.
5. Touch **Print** to begin printing.

## Print a Caller ID Report

You can print a list of Caller ID fax numbers.

### To print a Caller ID History Report

1. From the printer control panel display, touch **Setup**.
2. Touch **Fax Setup**, and then touch **Reports**.
3. Touch **Print Fax Reports**.
4. Touch **Caller ID Report**.
5. Touch **Print** to begin printing.

## View the Call History

You can view a list of all the calls placed from the printer.





---

**NOTE:** You cannot print the call history.

---

### To view the call history

1. From the printer control panel display, touch **Fax**.
2. Touch **Send Now**.

3. Touch  (Phone book).
4. Touch  (Call history).

---

# 7 Work with cartridges

- [Check the estimated ink levels](#)
- [Replace the cartridges](#)
- [Order ink supplies](#)
- [Use single-cartridge mode](#)
- [Cartridge warranty information](#)
- [Anonymous usage information storage](#)
- [Tips for working with cartridges](#)



# Check the estimated ink levels

## To check the estimated ink levels from the printer control panel

- ▲ From the Home screen, touch the  (Ink icon) to display the estimated ink levels.

## To check the ink levels from the printer software (Windows)

1. Open the HP printer software.
2. In the printer software, click **Estimated Ink Levels**.

## To check the ink levels from HP Utility

1. Open HP Utility.

HP Utility is located in the **Hewlett-Packard** folder in the **Applications** folder at the top level of the hard disk.

2. Select the HP Officejet 8040 series from the list of devices at the left of the window.
3. Click **Supplies Status**.

The estimated ink levels appear.

4. Click **All Settings** to return to the **Information and Support** pane.

---

 **NOTE:** If you have installed a refilled or remanufactured cartridge, or a cartridge that has been used in another printer, the ink level indicator might be inaccurate or unavailable.

 **NOTE:** Ink level warnings and indicators provide estimates for planning purposes only. When you receive a low-ink warning message, consider having a replacement cartridge available to avoid possible printing delays. You do not have to replace the cartridges until the print quality is unacceptable.

 **NOTE:** Ink from the cartridges is used in the printing process in a number of different ways, including in the initialization process, which prepares the product and cartridges for printing, and in printhead servicing, which keeps print nozzles clear and ink flowing smoothly. In addition, some residual ink is left in the cartridge after it is used. For more information, see [www.hp.com/go/inkusage](http://www.hp.com/go/inkusage).

---

# Replace the cartridges

## To replace the cartridges

1. Check that power is on.
2. Remove the old cartridge.
  - a. Open the access door.



- b. Remove the cartridge from the slot.
3. Insert a new cartridge.
  - a. Remove the cartridge from packaging.

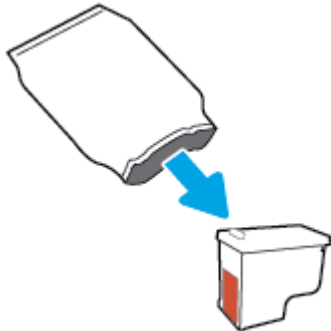

- b. Remove plastic tape using the pull tab.

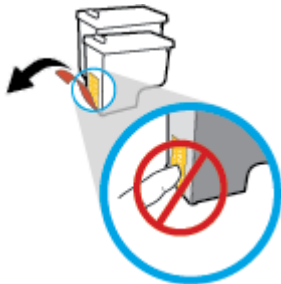

- c. Slide the new cartridge in the slot until it clicks.



4. Close the cartridge access door.



---

 **NOTE:** The HP printer software prompts you to align the ink cartridges when you print a document after installing a new ink cartridge.

---

# Order ink supplies

Before ordering cartridges, locate the correct cartridge number.

## Locate the cartridge number on the printer

- ▲ The cartridge number is located inside the cartridge access door.



## Locate the cartridge number in the printer software

1. Depending on your operating system, do one of the following to open the printer software:
  - **Windows 8.1:** Click the down arrow in lower left corner of the Start screen, and then select the printer name.
  - **Windows 8:** Right-click an empty area on the Start screen, click **All Apps** on the app bar, and then select the printer name.
  - **Windows 7, Windows Vista, and Windows XP:** From the computer desktop, click **Start**, select **All Programs**, click **HP**, click the folder for the printer, and then select the icon with the printer's name.
2. In the printer software, click **Shop**, and then click **Shop For Supplies Online**.

The correct cartridge number appears when you use this link.

## To find the print cartridge reorder numbers

1. Open HP Utility.

 **NOTE:** HP Utility is located in the **Hewlett-Packard** folder in the **Applications** folder at the top level of the hard disk.

2. Click **Supplies Info**.

The print cartridge ordering numbers appear.

3. Click **All Settings** to return to the **Information and Support** pane.

To order original HP supplies for the HP Officejet 8040 series, go to [www.hp.com/buy/supplies](http://www.hp.com/buy/supplies). If prompted, choose your country/region, and then follow the prompts to find the right cartridges for your printer.

 **NOTE:** Ordering ink cartridges online is not supported in all countries/regions. If it is not available in your country/region, you may still view supplies information and print a list for reference when shopping at a local HP reseller.

## Use single-cartridge mode

Use the single-cartridge mode to operate the HP Officejet 8040 series with only one ink cartridge. The single-cartridge mode is initiated when an ink cartridge is removed from the ink cartridge carriage. During single-cartridge mode, the printer can copy documents, copy photos, and print jobs from the computer.

---

 **NOTE:** When the HP Officejet 8040 series operates in single-cartridge mode, a message is displayed on the printer display. If the message is displayed and two ink cartridges are installed in the printer, verify that the protective piece of plastic tape has been removed from each ink cartridge. When plastic tape covers the ink cartridge contacts, the printer cannot detect that the ink cartridge is installed.

---

### Exit single-cartridge mode

- Install two ink cartridges in the HP Officejet 8040 series to exit single-cartridge mode.

## Cartridge warranty information

The HP cartridge warranty is applicable when the cartridge is used in its designated HP printing device. This warranty does not cover HP ink cartridges that have been refilled, remanufactured, refurbished, misused, or tampered with.

During the warranty period the cartridge is covered as long as the HP ink is not depleted and the end of warranty date has not been reached. The end of warranty date, in YYYY/MM format, may be found on the cartridge as indicated:

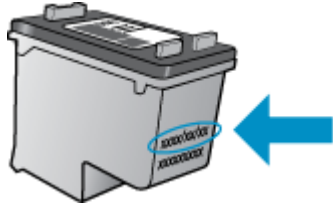

For a copy of the HP Limited Warranty Statement for the printer, see the printed documentation that came with the product.

# Anonymous usage information storage

The HP cartridges used with this printer contain a memory chip that assists in the operation of the printer. In addition, this memory chip stores a limited set of anonymous information about the usage of the printer, which might include the following: the number of pages printed using the cartridge, the page coverage, frequency of printing, and the printing modes used.

This information helps HP design future printers to meet our customers' printing needs. The data collected from the cartridge memory chip does not contain information that can be used to identify a customer or user of the cartridge or their printer.

HP collects a sampling of the memory chips from cartridges returned to HP's free return and recycling program (HP Planet Partners: [www.hp.com/recycle](http://www.hp.com/recycle)). The memory chips from this sampling are read and studied in order to improve future HP printers. HP partners who assist in recycling this cartridge might have access to this data, as well.

Any third party possessing the cartridge might have access to the anonymous information on the memory chip. If you prefer to not allow access to this information, you can render the chip inoperable. However, after you render the memory chip inoperable, the cartridge cannot be used in an HP printer.

If you are concerned about providing this anonymous information, you can make this information inaccessible by turning off the memory chip's ability to collect the printer's usage information.

## To disable the usage information function

1. From the printer control panel, touch **Setup**.
2. Touch **Preferences**.
3. Flick to the end of the option list and switch off the **Automatically Send Anonymous Data** and **Store Anonymous Usage Information** options.



---

**NOTE:** You can continue to use the cartridge in the HP printer if you turn off the memory chip's ability to collect the printer's usage information.

---

## Tips for working with cartridges

Use the following tips to work with cartridges:

- To protect the cartridges from drying out, always turn the printer off using the On button, and wait until the On button light goes out.
- Do not open or untape cartridges until you are ready to install them. Leaving tape on the cartridges reduces ink evaporation.
- Insert the cartridges into the correct slots. Match the color and icon of each cartridge to the color and icon for each slot. Make sure the cartridges snap into place.
- Alignment is automatic after new cartridge installation. Alignment can also help later, in cases of blurred or jagged lines. See [Fix print quality issues on page 107](#) for more information.
- When the Estimated Ink Levels screen shows one or both cartridges in a low state, consider getting replacement cartridges to avoid possible printing delays. You do not need to replace the cartridges until print quality becomes unacceptable. See [Replace the cartridges on page 76](#) for more information.
- If you remove a cartridge from the printer for any reason, try to replace it again as soon as possible. Outside of the printer, if unprotected, cartridges begin to dry out.



---

# 8 Connect Your Printer

Additional advanced settings are available from the printer's home page (embedded web server or EWS). For more information, see [Open the embedded Web server on page 93](#).

This section contains the following topics:

- [Set up the printer for wireless communication](#)
- [Change network settings](#)
- [Advanced printer management tools \(for networked printers\)](#)
- [Tips for setting up and using a networked printer](#)

# Set up the printer for wireless communication

- [Before you begin](#)
- [Set up the printer on your wireless network](#)
- [Change the connection type](#)
- [Test the wireless connection](#)
- [Turn on or off the wireless capability of the printer](#)
- [Connect wirelessly to the printer without a router](#)

## Before you begin

Ensure the following:

- The printer is not connected to the network using an Ethernet cable.
- The wireless network is set up and working properly.
- The printer and the computers that use the printer are on the same network (subnet).

While connecting the printer, you might be prompted to enter the wireless network name (SSID) and a wireless password.

- The wireless network name is the name of your wireless network.
- The wireless password prevents other people from connecting to your wireless network without your permission. Depending on the level of security required, your wireless network might use either a WPA passphrase or WEP key.

If you have not changed the network name or the security passkey since setting up your wireless network, you can sometimes find them on the back or side of the wireless router.

If you cannot find the network name or the security password or cannot remember this information, see the documentation provided with your computer or with the wireless router. If you still cannot find this information, contact your network administrator or the person who set up the wireless network.

## Set up the printer on your wireless network

Use the Wireless Setup Wizard from the printer control panel display to set up wireless communication.



---

**NOTE:** Before you proceed, go through the list at [Before you begin on page 84](#).

---

1. From the printer control panel, touch (Wireless).
2. Touch (Settings).
3. Touch **Wireless Settings**.
4. Touch **Wireless Setup Wizard**.
5. Follow the display instructions to complete the setup.

## Change the connection type

After you have installed the HP printer software and connected the printer to your computer or to a network, you can use the software to change the connection type (for example, from a USB connection to a wireless connection).



**NOTE:** Connecting an Ethernet cable turns off the wireless capability of the printer.

---

### To change from an Ethernet connection to a wireless connection (Windows)

1. Remove the Ethernet cable from the printer.
2. Open the printer software after the installation.  
Run the Wireless Setup Wizard to make the wireless connection.

### To change from a USB connection to a wireless network (Windows)

Before you proceed, go through the list at [Before you begin on page 84](#).

1. Depending on your operating system, do one of the following:
  - **Windows 8.1:** Click the down arrow in lower left corner of the Start screen, select the printer name, and then click **Utilities**.
  - **Windows 8:** Right-click an empty area on the Start screen, click **All Apps** on the app bar, select the printer name, and then click **Utilities**.
  - **Windows 7, Windows Vista, and Windows XP:** From the computer desktop, click **Start**, select **All Programs**, click **HP**, click the folder of your printer.
2. Click **Printer Setup & Software**.
3. Select **Convert a USB connected printer to wireless**. Follow the on-screen instructions.

### To change from a USB or Ethernet connection to a wireless connection (OS X)

Before you proceed, go through the list at [Before you begin on page 84](#).

1. Connect the printer to your wireless network.
2. Open **System Preferences**.
3. Depending on your operating system, click **Print & Fax**, **Print, Scan & Fax**, or **Printers & Scanners** in the **Hardware** section.
4. Select your printer in the left pane and click - at the bottom of the list. Do the same for the fax entry, if there is one for the current connection.
5. Open HP Utility.  
HP Utility is located in the **Hewlett-Packard** folder in the **Applications** folder at the top level of the hard disk.
6. Choose **Devices > HP Auto Wireless Connect** and follow the prompts.



Learn more about how to change from a USB to wireless connection. [Click here to go online for more information.](#) At this time, this website might not be available in all languages.

### To change from a wireless connection to a USB or Ethernet connection (Windows)

- Connect the USB or Ethernet cable to the printer.

### To change from a wireless connection to a USB or Ethernet connection (OS X)



Add the printer to the print queue.

1. Open **System Preferences**.
2. Depending on your operating system, click **Print & Fax**, **Print, Scan & Fax**, or **Printers & Scanners** in the **Hardware** section.
3. Select your printer in the left pane and click - at the bottom of the list. Do the same for the fax entry, if there is one for the current connection.
4. Open HP Utility.  
  
HP Utility is located in the **Hewlett-Packard** folder in the **Applications** folder at the top level of the hard disk.
5. Choose **Devices > Setup New Device** and follow the prompts.

## Test the wireless connection

Print the wireless test report for information about the printer wireless connection. The wireless test report provides information about the printer status, hardware (MAC) address, and IP address. If the printer is connected to a network, the test report displays details about the network settings.

To print the wireless test report

1. From the printer control panel, touch  (Wireless), and then touch  (**Settings**).
2. Touch **Print Reports**
3. Touch **Wireless Test Report**.

## Turn on or off the wireless capability of the printer

The blue Wireless light on the printer control panel is lit when the wireless capability of the printer is on.



---

**NOTE:** Connecting an Ethernet cable to the printer automatically turns off the wireless capability and the Wireless light.

---

1. From the printer control panel, touch **Setup** and then touch **Network Setup**.
2. Touch **Wireless Settings**.
3. Touch **Wireless** to turn it on or off.

## Connect wirelessly to the printer without a router

With Wi-Fi Direct, you can print wirelessly from a computer, smart phone, tablet, or other wireless-capable device—without connecting to an existing wireless network.

### Guidelines for using Wi-Fi Direct

- Make sure your computer or mobile device has the necessary software.  
If you are using a computer, make sure you have installed the printer software provided with the printer.
- If you have not installed the HP printer software on the computer, connect to Wi-Fi Direct first and then install the printer software. Select **Wireless** when prompted by the printer software for a connection type.
- If you are using a mobile device, make sure you have installed a compatible printing app. For more information about mobile printing, visit [www.hp.com/global/us/en/eprint/mobile\\_printing\\_apps.html](http://www.hp.com/global/us/en/eprint/mobile_printing_apps.html).
- Make sure Wi-Fi Direct is turned on in the printer and, if necessary, security is enabled.
- Up to five computers and mobile devices can use the same Wi-Fi Direct connection.
- Wi-Fi Direct can be used while the printer is also connected either to a computer using a USB cable or to a network using a wireless connection.
- Wi-Fi Direct cannot be used to connect a computer, mobile device, or printer to the Internet.

### To turn on Wi-Fi Direct

Wi-Fi Direct should be turned on by default. If it was turned off, follow the instructions below to turn it on again.

1. From the printer control panel, touch  (Wi-Fi Direct).
2. If **Status** is **Off**, touch  (**Wi-Fi Direct Settings**) and turn Wi-Fi Direct on.

---

 **TIP:** You can also turn on Wi-Fi Direct from the EWS. For more information about using the EWS, see [Open the embedded Web server on page 93](#).

---

### To print from a wireless-capable mobile device

Make sure you have installed a compatible printing app on your mobile device. For more information, visit [www.hp.com/global/us/en/eprint/mobile\\_printing\\_apps.html](http://www.hp.com/global/us/en/eprint/mobile_printing_apps.html).

1. Make sure you have turned on Wi-Fi Direct on the printer.
2. Turn on the Wi-Fi connection on your mobile device. For more information, see the documentation provided with the mobile device.

---

 **NOTE:** If your mobile device does not support Wi-Fi, you are not able to use Wi-Fi Direct.

---

3. From the mobile device, connect to a new network. Use the process you normally use to connect to a new wireless network or hotspot. Choose the Wi-Fi Direct name from the list of

wireless networks shown such as DIRECT-\*\*-HP Officejet-8040 (where \*\* are the unique characters to identify your printer).

Enter the Wi-Fi Direct password when prompted.

4. Print your document.

#### To print from a wireless-capable computer (Windows)

1. Make sure you have turned on Wi-Fi Direct on the printer.
2. Turn on the computer's Wi-Fi connection. For more information, see the documentation provided with the computer.



---

**NOTE:** If your computer does not support Wi-Fi, you are not able to use Wi-Fi Direct.

---

3. From the computer, connect to a new network. Use the process you normally use to connect to a new wireless network or hotspot. Choose the Wi-Fi Direct name from the list of wireless networks shown such as DIRECT-\*\*-HP Officejet-8040 (where \*\* are the unique characters to identify your printer and XXXX is the printer model located on the printer).

Enter the Wi-Fi Direct password when prompted.

4. Proceed to step 5 if the printer has been installed and connected to the computer over a wireless network. If the printer has been installed and connected to your computer with a USB cable, follow the steps below to install the printer software using the HP Wi-Fi Direct connection.

- a. Depending on your operating system, do one of the following:

- **Windows 8.1:** Click the down arrow in lower left corner of the Start screen, select the printer name, and then click **Utilities**.
- **Windows 8:** Right-click an empty area on the Start screen, click **All Apps** on the app bar, select the printer name, and then click **Utilities**.
- **Windows 7, Windows Vista, and Windows XP:** From the computer desktop, click **Start**, select **All Programs**, click **HP**, click the folder of your printer.

- b. Click **Printer Setup & Software**, and then select **Connect a new printer**.

- c. When the **Connection Options** software screen appears, select **Wireless**.

Select your HP printer software from the list of detected printers.

- d. Follow the on-screen instructions.

5. Print your document.

#### To print from a wireless-capable computer (OS X)

1. Make sure you have turned on Wi-Fi Direct on the printer.
2. Turn on Wi-Fi on the computer.

For more information, see the documentation provided by Apple.

3. Click the Wi-Fi icon and choose the Wi-Fi Direct name, such as DIRECT-\*\*-HP Officejet-8040 (where \*\* are the unique characters to identify your printer and XXXX is the printer model located on the printer).

If Wi-Fi Direct is turned on with security, enter the password when prompted.

4. Add the printer.
  - a. Open **System Preferences**.
  - b. Depending on your operating system, click **Print & Fax**, **Print, Scan & Fax**, or **Printers & Scanners** in the **Hardware** section.
  - c. Click + below the list of printers at the left.
  - d. Select the printer from the list of detected printers (the word “Bonjour” is listed the right column beside the printer name), and click **Add**.



[Click here](#) for online troubleshooting for Wi-Fi Direct, or for more help with setting up Wi-Fi

Direct. At this time, this website might not be available in all languages.

# Change network settings

From the printer control panel, you can set up and manage your printer wireless connection and perform a variety of network management tasks. This includes viewing and changing network settings, restoring network defaults, and turning the wireless function on or off.

---

 **CAUTION:** Network settings are provided for your convenience. However, unless you are an advanced user, you should not change some of these settings (such as the link speed, IP settings, default gateway, and firewall settings).

---

## To print the network configuration page

1. From the printer control panel, touch **Setup**.
2. Touch **Reports** and then touch **Network Configuration Report**.

## To set the link speed

You can change the speed at which data is transmitted over the network. The default is **Automatic**.

1. From the printer control panel, touch **Setup** and then touch **Network Setup**.
2. Touch **Ethernet Settings**.
3. Select **Advanced Settings**.
4. Touch **Link Speed**.
5. Touch the appropriate option that matches your network hardware.

## To change IP settings

The default IP setting for the IP settings is **Automatic**, which sets the IP settings automatically. If you are an advanced user and want to use different settings (such as the IP address, subnet mask, or the default gateway), you can change them manually.

---

 **CAUTION:** Be careful when manually assigning an IP address. If you enter an invalid IP address during the installation, your network components cannot connect with the printer.

---

1. From the printer control panel, touch **Setup** and then touch **Network Setup**.
2. Touch **Ethernet Settings** or **Wireless Settings**.
3. Touch **Advanced Settings**.
4. Touch **IP Settings**.
5. A message appears warning that changing the IP address removes the printer from the network. Touch **OK** to continue.
6. **Automatic** is selected by default. To change the settings manually, touch **Manual**, and then enter the appropriate information for the following settings:
  - **IP Address**
  - **Subnet Mask**



- **Default Gateway**
  - **DNS Address**
7. Enter your changes, and then touch **Done**.
  8. Touch **OK**.

# Advanced printer management tools (for networked printers)

To view or change some settings, you might need a password.

---

 **NOTE:** You can open and use the embedded Web server without being connected to the Internet. However, some features are not available.

---

This section contains the following topics:

- [Toolbox \(Windows\)](#)
- [HP Utility \(OS X\)](#)
- [Open the embedded Web server](#)
- [About cookies](#)

## Toolbox (Windows)

The Toolbox provides maintenance information about the printer.

---

 **NOTE:** The Toolbox can be installed from the HP Software CD if the computer meets the system requirements. System requirements can be found in the Readme file, which is available on the HP printer software CD provided with your printer.

---

### To open the Toolbox

1. Depending on your operating system, do one of the following:
  - **Windows 8.1:** Click the down arrow in lower left corner of the Start screen, and then select the printer name.
  - **Windows 8:** Right-click an empty area on the Start screen, click **All Apps** on the app bar, and then select the printer name.
  - **Windows 7, Windows Vista, and Windows XP:** From the computer desktop, click **Start**, select **All Programs**, click **HP**, click the folder for the printer, and then select the icon with the printer's name.
2. Click **Print, Scan & Fax**.
3. Click **Maintain Your Printer**.

## HP Utility (OS X)

HP Utility contains tools to configure print settings, calibrate the printer, order supplies online, and find website support information.

---

 **NOTE:** The features available in HP Utility vary depending on the selected printer.

---

Ink level warnings and indicators provide estimates for planning purposes only. When you receive a low-ink warning message, consider having a replacement cartridge available to avoid possible printing delays. You do not need to replace cartridges until the print quality becomes unacceptable.

---

Double-click HP Utility in the **Hewlett-Packard** folder in the **Applications** folder at the top level of the hard disk.

## Open the embedded Web server

You can access the embedded Web server via either the network or Wi-Fi Direct.

### To open the embedded Web server via network

---



 **NOTE:** The printer must be on a network and must have an IP address. The IP address for the printer can be found by pressing the Wireless icon or by printing a network configuration page.

---

- In a supported Web browser on your computer, type the IP address or hostname that has been assigned to the printer.

For example, if the IP address is 192.168.0.12, type the following address into a Web browser: `http://192.168.0.12`.

### To open the embedded Web server using Wi-Fi Direct

1. From the Home screen, touch  (**Wireless**) and then touch  (**Settings**).
2. If the display shows that Wi-Fi Direct is **Off**, touch **Wi-Fi Direct** and then switch it on.
3. From your wireless computer, turn wireless on, search for and connect to the Wi-Fi Direct name, for example: DIRECT-\*\*-HP Officejet-8040 (where \*\* are the unique characters to identify your printer). Enter the Wi-Fi Direct password when prompted.
4. In a supported Web browser on your computer, type the following address: `http://192.168.223.1`.

## About cookies

The embedded Web server (EWS) places very small text files (cookies) on your hard drive when you are browsing. These files let the EWS recognize your computer the next time you visit. For example, if you have configured the EWS language, a cookie helps remember which language you have selected so that the next time you access the EWS, the pages are displayed in that language. Some cookies (such as the cookie that stores customer-specific preferences) are stored on the computer until you clear them manually.

You can configure your browser to accept all cookies, or you can configure it to alert you every time a cookie is offered, which allows you to decide which cookies to accept or refuse. You can also use your browser to remove unwanted cookies.

---

 **NOTE:** Depending on your printer, if you disable cookies, you also disable one or more of the following features:

---

- Starting where you left the application (especially useful when using setup wizards)
- Remembering the EWS browser language setting
- Personalizing the EWS Home page

For information about how to change your privacy and cookie settings and how to view or delete cookies, see the documentation available with your Web browser.

## Tips for setting up and using a networked printer

Use the following tips to set up and use a networked printer:

- When setting up the wireless networked printer, make sure your wireless router is powered on. The printer searches for wireless routers, then lists the detected network names on the display.



---

**NOTE:** If your printer has not been setup with a wireless connection, touch **Wireless** and then touch **Settings** on the printer display to start the Wireless Setup Wizard.

---

- To check the wireless connection on the printer, touch the **Wireless** on the control panel to open the Wireless Summary menu. If it shows **Wireless Off** or **Not Connected**, touch **Settings** and then touch **Wireless Setup Wizard**. Follow the on-screen instructions to set up your printer wireless connection.
- If your computer is connected to a Virtual Private Network (VPN), you need to disconnect from the VPN before you can access any other device on your network, including the printer.
- Learn more about configuring your network and the printer for wireless printing. [Click here to go online for more information.](#)
- Learn how to find your network security settings. [Click here to go online for more information.](#)
- Learn about the Print and Scan Doctor (Windows only) and other troubleshooting tips. [Click here to go online for more information.](#)
- Learn how to change from a USB to wireless connection. [Click here to go online for more information.](#)
- Learn how to work with your firewall and anti-virus programs during printer setup. [Click here to go online for more information.](#)

---

# 9 Solve a problem

This section contains the following topics:

- [Jams and paper-feed issues](#)
- [Ink cartridge issues](#)
- [Printing issues](#)
- [Copy issues](#)
- [Scan issues](#)
- [Fax issues](#)
- [Network and connection issues](#)
- [Printer hardware issues](#)
- [HP support](#)

# Jams and paper-feed issues

What do you want to do?

## Clear a paper jam

<a href="#">Solve paper jam issues.</a>	Use an HP online troubleshooting wizard  Instructions for clearing the jam in the printer or in the automatic document feeder and resolving issues with paper or the paper feed.
---	--

 **NOTE:** The HP online troubleshooting wizards may not be available in all languages.

## Read general instructions in the Help for clearing paper jams

Paper jams can occur in several locations inside the printer.

 **CAUTION:** To prevent possible damage to the printhead, clear paper jams as soon as possible.

## To clear an internal paper jam

 **CAUTION:** Avoid pulling jammed paper from the front of the printer. Instead follow the steps below to clear the jam. Pulling out jammed paper from the front of the printer might cause the paper to tear and leave torn pieces inside the printer; this could result in more jams later.

1. Press the  (**Power** button) to turn the printer off.
2. Open the ink cartridge access door.



3. Check the paper path inside the printer.
  - a. Lift the handle of the paper path cover and remove the cover.

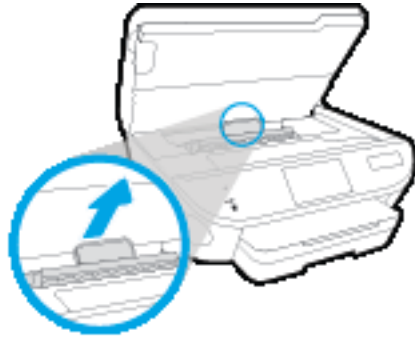

- b. Locate any jammed paper inside the printer, grasp it with both hands and pull it towards you.



---

**⚠ CAUTION:** If the paper tears when you are removing it from the rollers, check the rollers and wheels for torn pieces of paper that might be remaining inside the printer.

If you do not remove all the pieces of paper from the printer, more paper jams are likely to occur.

---

- c. Reinsert the paper path cover until it snaps into place.
4. If the problem is not resolved, check the print carriage area inside the printer.

---

**⚠ CAUTION:** During the process, avoid touching the cable attached to the print carriage.

---

- a. If there is any jammed paper, move the print carriage to the far right of the printer, grasp the jammed paper with both hands, and then pull it towards you.

---

**⚠ CAUTION:** If the paper tears when you are removing it from the rollers, check the rollers and wheels for torn pieces of paper that might be remaining inside the printer.

If you do not remove all the pieces of paper from the printer, more paper jams are likely to occur.

---

- b. Move the carriage to the far left of the printer, and do the same as in the previous step to remove any torn pieces of paper.
5. Close the ink cartridge access door.
  6. If the problem is still not resolved, check the tray area.
    - a. Pull out the input tray to extend it.

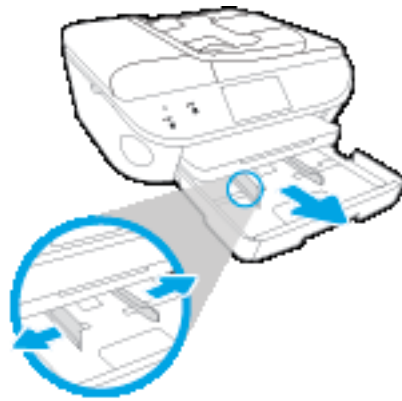

- b. Carefully turn the printer on its side to expose the bottom of the printer.
- c. Check the gap in the printer where the input tray was. If there is any jammed paper, reach into the gap, grasp the paper with both hands and pull it towards you.

---

**⚠ CAUTION:** If the paper tears when you are removing it from the rollers, check the rollers and wheels for torn pieces of paper that might be remaining inside the printer.

If you do not remove all of the pieces of paper from the printer, more paper jams are likely to occur.

---

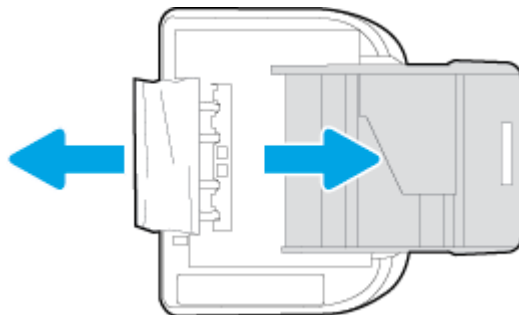





- d. Carefully turn the printer up again.
  - e. Push the paper tray back in.
7. Press the  (**Power** button) again to turn the printer on.

### To clear a paper jam in the document feeder

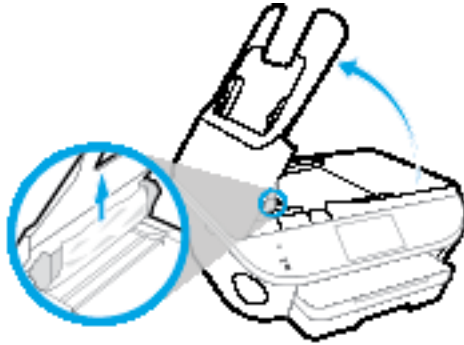
1. Lift the cover of the document feeder.



2. Gently pull the jammed paper out of the rollers.

 **CAUTION:** If the paper tears when you are removing it from the rollers, check the rollers and wheels for torn pieces of paper that might remain inside the printer.

If you do not remove all the pieces of paper from the printer, more paper jams are likely to occur.

3. Close the document feeder cover, pressing down firmly until it snaps into place.

## Clear a print carriage jam

[Resolve a print carriage jam.](#)

Use an HP online troubleshooting wizard

If something is blocking the print carriage or it does not move easily, get step-by-step instructions.

 **NOTE:** The HP online troubleshooting wizards may not be available in all languages.

### Read general instructions in the Help for clearing a print carriage jams

1. Remove any objects, such as paper, that are blocking the print carriage.

 **NOTE:** Do not use any tools or other devices to remove jammed paper. Always use caution when removing jammed paper from inside the printer

2. To get help from the print display, touch **Help** from the Home screen. Touch the directional button to navigate through help topics, touch **Troubleshoot and Support**, and then touch **Clear Carriage Jam**.

## Learn how to avoid paper jams

To help avoid paper jams, follow these guidelines.

- Remove printed papers from the output tray frequently.
- Make sure that you are printing with paper that is not wrinkled, folded, or damaged.
- Prevent curled or wrinkled paper by storing all unused paper flat in a resealable bag.
- Do not use paper that is too thick or too thin for the printer.
- Make sure that the trays are loaded correctly and are not too full. For more information, see [Load media on page 12](#).
- Ensure that paper loaded in the input tray lays flat and the edges are not bent or torn.
- Do not place too much paper in the document feeder tray. For information on the maximum number of sheets allowed in the document feeder, see [Specifications on page 132](#).
- Do not combine different paper types and paper sizes in the input tray; the entire stack of paper in the input tray must be the same size and type.
- Adjust the paper-width guides in the input tray to fit snugly against all paper. Make sure the paper-width guides do not bend the paper in the input tray.
- Do not force paper too far inside the input tray.
- If you are printing on both sides of a page, do not print highly saturated images on light weight paper.
- Use paper types that are recommended for the printer. For more information, see [Paper basics on page 9](#).
- If the printer is about to run out of paper, allow the printer to run out of paper first, and then add paper. Do not load paper when the printer is printing.

## Solve paper-feed problems

What kind of problem are you having?

- **Paper is not picked up from a tray**
  - Make sure paper is loaded in the tray. For more information, see [Load media on page 12](#). Fan the paper before loading.
  - Make sure the paper-width guides are set to the correct markings in the tray for the paper size you are loading. Also make sure the paper guides are snug, but not tight, against the stack.
  - Make sure paper in the tray is not curled. Uncurl paper by bending it in the opposite direction of the curl.
- **Pages are skewing**

- Make sure the paper loaded in the input tray is aligned to the paper-width guides. If needed, pull out the input tray from the printer and reload the paper correctly, making sure that the paper guides are aligned correctly.
- Load paper into the printer only when it is not printing.
- **Multiple pages are being picked up**
  - Make sure the paper-width guides are set to the correct markings in the tray for the paper size you are loading. Also make sure the paper-width guides are snug, but not tight, against the stack.
  - Make sure the tray is not overloaded with paper.
  - Use HP paper for optimum performance and efficiency.

# Ink cartridge issues

First try removing and reinserting the ink cartridges. Make sure the cartridges are in the correct slots. If this does not work, clean the cartridge contacts. If your problem is still not resolved, see [Replace the cartridges on page 76](#) for more information.

## To clean cartridge contacts

**CAUTION:** The cleaning procedure should take only a few minutes. Make sure that the ink cartridges are reinstalled in the product as soon as possible. It is not recommended to leave the ink cartridges outside of the product longer than 30 minutes. This could result in damage to the ink cartridges.

1. Check that power is on.
2. Open the cartridge access door.



3. Remove the cartridge indicated in the error message.
4. Hold the ink cartridge by its sides with the bottom pointing up and locate the electrical contacts on the ink cartridge. The electrical contacts are the small gold-colored dots on the ink cartridge.

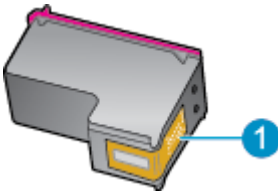

Feature	Description
1	Electrical contacts

5. Wipe only the contacts with a damp lint-free cloth.

**CAUTION:** Be careful to touch only the contacts, and do not smear any of the ink or other debris elsewhere on the cartridge.

6. On the inside of the printer, locate the contacts in the print carriage. The contacts look like a set of gold-colored bumps positioned to meet the contacts on the ink cartridge.
7. Wipe only the contacts with a damp lint-free cloth.
8. Reinstall the ink cartridge.

9. Close the access door, and check if the error message has gone away.
10. If you still receive the error message, turn the product off, and then on again.



---

**NOTE:** If one ink cartridge is causing problems, you can remove it and use the single-cartridge mode to operate the HP Officejet 8040 series with only one cartridge.

---

# Printing issues

What do you want to do?

## Fix problems with page not printing (unable to print)

<a href="#">HP Print and Scan Doctor</a>	The HP Print and Scan Doctor is a utility that will try to diagnose and fix the issue automatically.
<a href="#">Troubleshoot problems with print jobs not printing.</a>	Use an HP online troubleshooting wizard Get step-by-step instructions if the printer is not responding or printing.

 **NOTE:** The HP Print and Scan Doctor and the HP online troubleshooting wizards may not be available in all languages.

## Read general instructions in the Help for unable to print issues

### Resolve print issues

 **NOTE:** Make sure that the printer is turned on and that there is paper in the tray. If you are still unable to print, try the following in order:

1. Check for error messages from the printer display and resolve them by following the onscreen instructions.
2. If your computer is connected to the printer with a USB cable, disconnect and reconnect the USB cable. If your computer is connected to the printer with a wireless connection, confirm that the connection is working.
3. Verify that the printer is not paused or offline.

#### To verify that the printer is not paused or offline

- a. Depending on your operating system, do one of the following:
  - **Windows 8.1 and Windows 8:** Point to or tap the upper-right corner of the screen to open the Charms bar, click the **Settings** icon, click or tap **Control Panel**, and then click or tap **View devices and printers**.
  - **Windows 7:** From the Windows **Start** menu, click **Devices and Printers**.
  - **Windows Vista:** From the Windows **Start** menu, click **Control Panel**, and then click **Printers**.
  - **Windows XP:** From the Windows **Start** menu, click **Control Panel**, and then click **Printers and Faxes**.
- b. Either double-click the icon for your printer or right-click the icon for your printer and select **See what's printing** to open the print queue.
- c. On the **Printer** menu, make sure there are no check marks next to **Pause Printing** or **Use Printer Offline**.
- d. If you made any changes, try to print again.

4. Verify that the printer is set as the default printer.

#### To verify that the printer is set as the default printer

- a. Depending upon your operating system, do one of the following:
    - **Windows 8.1 and Windows 8:** Point to or tap the upper-right corner of the screen to open the Charms bar, click the **Settings** icon, click or tap **Control Panel**, and then click or tap **View devices and printers**.
    - **Windows 7:** From the Windows **Start** menu, click **Devices and Printers**.
    - **Windows Vista:** From the Windows **Start** menu, click **Control Panel**, and then click **Printers**.
    - **Windows XP:** From the Windows **Start** menu, click **Control Panel**, and then click **Printers and Faxes**.
  - b. Make sure the correct printer is set as the default printer.

The default printer has a check mark in a black or green circle next to it.
  - c. If the wrong printer is set as the default printer, right-click the correct printer and select **Set as Default Printer**.
  - d. Try using your printer again.
5. Restart the print spooler.

#### To restart the print spooler

- a. Depending upon your operating system, do one of the following:
  - Windows 8.1 and Windows 8**
    - i. Point to or tap the upper-right corner of the screen to open the Charms bar, and then click the **Settings** icon.
    - ii. Click or tap **Control Panel**, and then click or tap **System and Security**.
    - iii. Click or tap **Administrative Tools**, and then double-click or double-tap **Services**.
    - iv. Right-click or touch and hold **Print Spooler**, and then click **Properties**.
    - v. On the **General** tab, next to **Startup type**, make sure that **Automatic** is selected.
    - vi. If the service is not already running, under **Service status**, click or tap **Start**, and then click or tap **OK**.

#### Windows 7

- i. From the Windows **Start** menu, click **Control Panel**, **System and Security**, and then **Administrative Tools**.
- ii. Double-click **Services**.
- iii. Right-click the **Print Spooler**, and then click **Properties**.

- iv. On the **General** tab, next to **Startup type**, make sure that **Automatic** is selected.
- v. If the service is not already running, under **Service status**, click **Start**, and then click **OK**.

### Windows Vista

- i. From the Windows **Start** menu, click **Control Panel, System and Maintenance, Administrative Tools**.
- ii. Double-click **Services**.
- iii. Right-click the **Print Spooler service**, and then click **Properties**.
- iv. On the **General** tab, next to **Startup type**, make sure that **Automatic** is selected.
- v. If the service is not already running, under **Service status**, click **Start**, and then click **OK**.

### Windows XP

- i. From the Windows **Start** menu, right click **My Computer**.
  - ii. Click **Manage**, and then click **Services and Applications**.
  - iii. Double-click **Services**, and then select **Print Spooler**.
  - iv. Right-click **Print Spooler**, and click **Restart** to restart the service.
- b. Make sure the correct printer is set as the default printer.
- The default printer has a check mark in a black or green circle next to it.
- c. If the wrong printer is set as the default printer, right-click the correct printer and select **Set as Default Printer**.
- d. Try using your printer again.
6. Restart the computer.
7. Clear the print queue.

### To clear the print queue

- a. Depending upon your operating system, do one of the following:
  - **Windows 8.1 and Windows 8:** Point to or tap the upper-right corner of the screen to open the Charms bar, click the **Settings** icon, click or tap **Control Panel**, and then click or tap **View devices and printers**.
  - **Windows 7:** From the Windows **Start** menu, click **Devices and Printers**.
  - **Windows Vista:** From the Windows **Start** menu, click **Control Panel**, and then click **Printers**.
  - **Windows XP:** From the Windows **Start** menu, click **Control Panel**, and then click **Printers and Faxes**.
- b. Double-click the icon for your printer to open the print queue.



- c. On the **Printer** menu, click **Cancel all documents** or **Purge Print Document**, and then click **Yes** to confirm.
- d. If there are still documents in the queue, restart the computer and try printing again after the computer has restarted.
- e. Check the print queue again to make sure it is clear, and then try to print again.

### To check the power connection and reset the printer

1. Make sure the power cord is firmly connected to the printer.

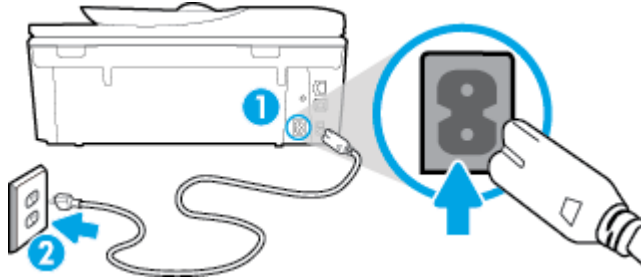

1	Power connection to the printer
2	Connection to a power outlet

2. Look inside the printer and check for a green light indicating the printer is receiving electrical power. If it is not lit, make sure the cord is fully plugged into the printer, or connect to another power outlet.
3. Look at the On button located on the printer. If it is not lit, the printer is turned off. Press the On button to turn on the printer.



**NOTE:** If the printer is not receiving electrical power, connect it to another power outlet.

4. With the printer turned on, disconnect the power cord from the side of the printer under the cartridge access door.
5. Unplug the power cord from the wall outlet.
6. Wait at least 15 seconds.
7. Plug the power cord back into the wall outlet.
8. Reconnect the power cord to the side of the printer under the cartridge access door.
9. If the printer does not turn on by itself, press the On button to turn on the printer.
10. Try using the printer again.

## Fix print quality issues

<a href="#">Step-by-step instructions for resolving most print quality issues.</a>	Troubleshoot print quality issues online
--	--

## Read general instructions in the Help for resolving print quality issues

 **NOTE:** To avoid print quality problems, always turn the printer off using the **On** button, and wait until the **On** button light goes out before you pull the plug or turn off a power strip. This allows the printer to move the cartridges to a capped position, where they are protected from drying out.

### To improve print quality

1. Make sure you are using original HP ink cartridges.
2. Check the printer software to make sure you have selected the appropriate paper type from the **Media** drop-down list and print quality from the **Quality Settings** drop-down list.
  - In the printer software, click **Print, Scan & Fax** and then click **Set Preferences** to access the print properties.
3. Check the estimated ink levels to determine if the cartridges are low on ink. For more information, see [Check the estimated ink levels on page 75](#). If the ink cartridges are low on ink consider replacing them.
4. Align the cartridges.

### To align the cartridges from the printer software

 **NOTE:** Aligning the cartridges ensures the high-quality output. The HP All-in-One prompts you to align the cartridges every time you install a new cartridge. If you remove and reinstall the same ink cartridge, the HP All-in-One will not prompt you to align the ink cartridges. The HP All-in-One remembers the alignment values for that ink cartridge, so you do not need to realign the ink cartridges.

- a. Load letter or A4 unused plain white paper into the paper tray.
- b. Depending on your operating system, do one of the following to open the printer software:
- c. In the printer software, click **Print, Scan & Fax**, and then click **Maintain Your Printer** to access the **Printer Toolbox**.
- d. In **Printer Toolbox**, click **Align Ink Cartridges** on the **Device Services** tab. The printer prints an alignment sheet.
- e. Load the cartridge alignment sheet print side down on the right front corner of the scanner glass.

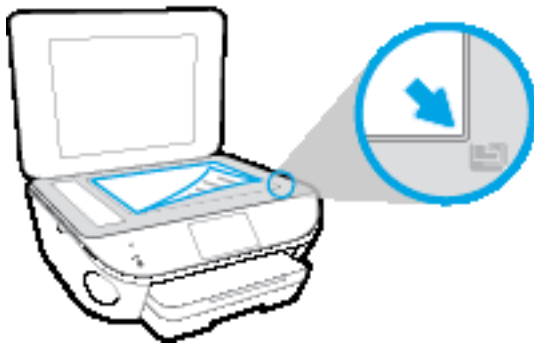

- f. Follow the instructions on the printer display to align the cartridges. Recycle or discard the cartridge alignment sheet.

### To align the cartridges from the printer display

- a. Load Letter or A4 unused plain white paper into the input tray.
  - b. From the printer control panel display, touch **Setup**.
  - c. Touch **Printer Maintenance**, select **Align Printhead**, and then follow the on-screen instructions.
5. Print a diagnostics page if the cartridges are not low on ink.

### To print a diagnostics page from the printer software

- a. Load letter or A4 unused plain white paper into the paper tray.
- b. Depending on your operating system, do one of the following to open the printer software:
- c. In the printer software, click **Print, Scan & Fax**, and then click **Maintain Your Printer** to access the printer toolbox.
- d. Click **Print Diagnostic Information** on the **Device Reports** tab to print a diagnostics page. Review the blue, magenta, yellow, and black boxes on the diagnostics page. If you are seeing streaks in the color and black boxes, or no ink in portions of the boxes, then automatically clean the cartridges.

### To print a diagnostics page from the printer display

- a. Load letter or A4 unused plain white paper into the paper tray.
  - b. From the printer control panel, touch **Setup**.
  - c. Touch **Reports**.
  - d. Touch **Print Quality Report**.
6. Clean the ink cartridges automatically, if the diagnostic page shows streaks or missing portions of the color and black boxes.

### To clean the cartridges from the printer software

- a. Load letter or A4 unused plain white paper into the paper tray.
- b. Depending on your operating system, do one of the following to open the printer software:
  - **Windows 8.1:** Click the down arrow in lower left corner of the Start screen, and then select the printer name.
  - **Windows 8:** Right-click an empty area on the Start screen, click **All Apps** on the app bar, and then select the printer name.
  - **Windows 7, Windows Vista, and Windows XP:** From the computer desktop, click **Start**, select **All Programs**, click **HP**, click the folder for the printer, and then select the icon with the printer's name.
- c. In the printer software, click **Print, Scan & Fax** and then click **Maintain Your Printer** to access the **Printer Toolbox**.
- d. Click **Clean Ink Cartridges** on the **Device Services** tab. Follow the on-screen instructions.

### To clean the cartridges from the printer display

- a. Load Letter or A4 unused plain white paper into the input tray.
- b. From the printer control panel display, touch **Setup**.
- c. Touch **Printer Maintenance**, select **Clean Printhead**, and then follow the on-screen instructions.

If cleaning the printhead does not solve the problem, contact HP support. Go to [www.hp.com/support](http://www.hp.com/support). This website provides information and utilities that can help you correct many common printer problems. If prompted, select your country/region, and then click **All HP Contacts** for information on calling for technical support.

### To improve print quality

1. Make sure you are using original HP cartridges.
2. Make sure you have selected the appropriate paper type and print quality in the **Print** dialog.
3. Check the estimated ink levels to determine if the cartridges are low on ink.  
Consider replacing the print cartridges if they are low on ink.
4. Align the printer cartridges

### To align print cartridges from the software

- a. Load Letter or A4 plain, white paper in the paper tray.
- b. Open HP Utility.



---

**NOTE:** HP Utility is located in the **Hewlett-Packard** folder in the **Applications** folder at the top level of the hard disk.

---

- c. Select the HP Officejet 8040 series from the list of devices at the left of the window.
  - d. Click **Align**.
  - e. Click **Align** and follow the on-screen instructions.
  - f. Click **All Settings** to return to the **Information and Support** pane.
5. Print a test page.

### To print a test page

- a. Load Letter or A4 plain, white paper in the paper tray.
- b. Open HP Utility.



---

**NOTE:** HP Utility is located in the **Hewlett-Packard** folder in the **Applications** folder at the top level of the hard disk.

---

- c. Select the HP Officejet 8040 series from the list of devices at the left of the window.

- d. Click **Test Page**.
  - e. Click the **Print Test Page** button, and follow the on-screen instructions.  
Check the test page for jagged lines in the text or streaks in the text and colored boxes. If you are seeing jagged lines, or streaks, or no ink in portions of the boxes, then automatically clean the cartridges.
6. If the diagnostic page shows streaks or missing portions of the text or colored boxes, clean the print cartridges automatically.

#### To automatically clean the print head

- a. Load Letter or A4 plain, white paper in the paper tray.
- b. Open HP Utility.

---

 **NOTE:** HP Utility is located in the **Hewlett-Packard** folder in the **Applications** folder at the top level of the hard disk.

---

- c. Select the HP Officejet 8040 series from the list of devices at the left of the window.
- d. Click **Clean Printheads**.
- e. Click **Clean**, and follow the on-screen instructions.

---

 **CAUTION:** Clean the print head only when necessary. Unnecessary cleaning wastes ink and shortens the life of the print head.

---

 **NOTE:** If print quality still seems poor after you complete cleaning, try aligning the printer. If print quality problems persist after cleaning and aligning, contact HP support.

---

- f. Click **All Settings** to return to the **Information and Support** pane.

### Fix ink smears on printouts

If a printout shows smears of ink, for subsequent prints, try using the Clean Ink Smear function from the printer display. This process takes several minutes to complete. Full-size plain paper needs to be loaded and will be moved back and forth during the cleaning. Mechanical noises are normal at this time.

1. Load Letter or A4 unused plain white paper into the input tray.
2. From the printer control panel display, touch **Setup**.
3. Touch **Printer Maintenance**, select the desired option, and then follow the on-screen instructions.

---

 **NOTE:** You can also do the same from the HP printer software or embedded web server (EWS). To access the software or EWS, see [Open the HP printer software \(Windows\) on page 18](#) or [Open the embedded Web server on page 93](#).

---

## Copy issues

---

[Troubleshoot copy problems.](#)

Use an HP online troubleshooting wizard

Get step-by-step instructions if the printer does not create a copy, or if your printouts are low quality.

---



**NOTE:** The HP online troubleshooting wizards may not be available in all languages.

---

[Tips for copy and scan success on page 38](#)

## Scan issues

<a href="#">HP Print and Scan Doctor</a>	The HP Print and Scan Doctor is a utility that will try to diagnose and fix the issue automatically.
<a href="#">Solve scan problems</a>	Use an HP online troubleshooting wizard Get step-by-step instructions if you cannot create a scan or if your scans are low quality.

 **NOTE:** The HP Print and Scan Doctor and the HP online troubleshooting wizards may not be available in all languages.

[Tips for copy and scan success on page 38](#)

# Fax issues

Run the fax test report first to see if there is a problem with your fax setup. If the test passes and you are still having problems faxing, check the fax settings listed in the report to verify that the settings are correct.

## Run the fax test

You can test your fax setup to check the status of the printer and to make sure it is set up correctly for faxing. Perform this test only after you have completed fax setup on the printer. The test does the following:

- Tests the fax hardware
- Verifies that the correct type of phone cord is connected to the printer
- Checks that the phone cord is plugged into the correct port
- Checks for a dial tone
- Tests the status of your phone line connection
- Checks for an active phone line

### To test fax setup via the printer control panel

1. Set up the printer for faxing according to your particular home or office setup instructions.
2. Make sure the ink cartridges are installed and that full-size paper is loaded in the input tray before starting the test.
3. On the **Fax** screen, flick to the right and touch **Setup**, touch **Setup Wizard**, and then follow the onscreen instructions.

The printer displays the status of the test on the display and prints a report.

4. To test fax setup via the printer control panel
5. Review the report.
  - If the fax test failed, review the solutions below.
  - If the fax test passed and you are still having problems faxing, verify that the fax settings listed in the report are correct. You can also use HP's online troubleshooting wizard.

## What to do if the fax test failed

If you ran a fax test and the test failed, review the report for basic information about the error. For more detailed information, check the report to see which part of the test failed, and then review the appropriate topic in this section for solutions to try.



### The "Fax Hardware Test" failed

- Turn the printer off by pressing  (Power button) located on the printer control panel and then unplug the power cord from the back of the printer. After a few seconds, plug the power cord in again, and then turn the power on. Run the test again. If the test fails again, continue reviewing the troubleshooting information in this section.
- Try to send or receive a test fax. If you can send or receive a fax successfully, there might not be a problem.
- If you are running the test from the **Fax Setup Wizard** (Windows) or **HP Utility** (OS X), make sure the printer is not busy completing another task, such as receiving a fax or making a copy. Check the display for a message indicating that the printer is busy. If it is busy, wait until it is finished and in the idle state before running the test.
- Make sure you use the phone cord that came with the printer. If you do not use the supplied phone cord to connect from the telephone wall jack to the printer, you might not be able to send or receive faxes. After you plug in the phone cord that came with the printer, run the fax test again.
- If you are using a phone splitter, this can cause faxing problems. (A splitter is a two-cord connector that plugs into a telephone wall jack.) Try removing the splitter and connecting the printer directly to the telephone wall jack.

After you resolve any problems found, run the fax test again to make sure it passes and the printer is ready for faxing. If the **Fax Hardware Test** continues to fail and you experience problems faxing, contact HP support. Go to [www.hp.com/support](http://www.hp.com/support). This website provides information and utilities that can help you correct many common printer problems. If prompted, select your country/region, and then click **All HP Contacts** for information on calling for technical support.

### The "Fax Connected to Active Telephone Wall Jack" test failed

- Check the connection between the telephone wall jack and the printer to make sure the phone cord is secure.
- Make sure you use the phone cord that came with the printer. If you do not use the supplied phone cord to connect from the telephone wall jack to the printer, you might not be able to send or receive faxes. After you plug in the phone cord that came with the printer, run the fax test again.
- Make sure you have correctly connected the printer to the telephone wall jack. Using the phone cord supplied in the box with the printer, connect one end to your telephone wall jack, then connect the other end to the port labeled 1-LINE on the back of the printer.

Learn more about fax setup and test, [click here to go online for more information](#).

- If you are using a phone splitter, this can cause faxing problems. (A splitter is a two-cord connector that plugs into a telephone wall jack.) Try removing the splitter and connecting the printer directly to the telephone wall jack.
- Try connecting a working phone and phone cord to the telephone wall jack that you are using for the printer and check for a dial tone. If you do not hear a dial tone, contact your telephone company and have them check the line.
- Try to send or receive a test fax. If you can send or receive a fax successfully, there might not be a problem.

After you resolve any problems found, run the fax test again to make sure it passes and the printer is ready for faxing.

### The "Phone Cord Connected to Correct Port on Fax" test failed

Make sure you use the phone cord that came with the printer. If you do not use the supplied phone cord to connect from the telephone wall jack to the printer, you might not be able to send or receive faxes. After you plug in the phone cord that came with the printer, run the fax test again.

If you are using a phone splitter, this can cause faxing problems. (A splitter is a two-cord connector that plugs into a telephone wall jack.) Try removing the splitter and connecting the printer directly to the telephone wall jack.

#### Plug the phone cord into the correct port

1. Using the phone cord supplied in the box with the printer, connect one end to your telephone wall jack, then connect the other end to the port labeled 1-LINE on the back of the printer.

 **NOTE:** If you use the 2-EXT port to connect to the telephone wall jack, you cannot send or receive faxes. The 2-EXT port should only be used to connect other equipment, such as an answering machine.

Figure 9-1 Back view of the printer



1	Telephone wall jack
2	Use the phone cord supplied in the box with the printer to connect to the "1-LINE" port

2. After you have connected the phone cord to the port labeled 1-LINE, run the fax test again to make sure it passes and the printer is ready for faxing.
3. Try to send or receive a test fax.

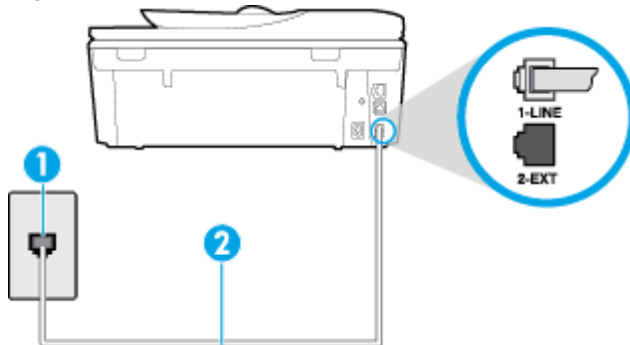
### The "Using Correct Type of Phone Cord with Fax" test failed

- Make sure you used the phone cord supplied in the box with the printer to connect to the telephone wall jack. One end of the phone cord should be connected to the port labeled 1-LINE on the back of the printer, and the other end to your telephone wall jack, as shown in the illustration.

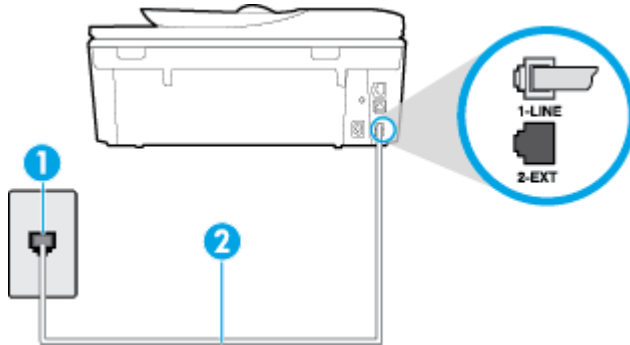

1	Telephone wall jack
2	Use the phone cord supplied in the box with the printer to connect to the "1-LINE" port

- If the phone cord that came with the printer is not long enough, you can use a longer 2-wire phone cord to extend the length. You can purchase the cord at an electronics store that carries phone accessories.
- Check the connection between the telephone wall jack and the printer to make sure the phone cord is secure.
  - Make sure you use the phone cord that came with the printer. If you do not use the supplied phone cord to connect from the telephone wall jack to the printer, you might not be able to send or receive faxes. After you plug in the phone cord that came with the printer, run the fax test again.
  - If you are using a phone splitter, this can cause faxing problems. (A splitter is a two-cord connector that plugs into a telephone wall jack.) Try removing the splitter and connecting the printer directly to the telephone wall jack.

### The "Dial Tone Detection" test failed

- Other equipment, which uses the same phone line as the printer, might be causing the test to fail. To find out if other equipment is causing a problem, disconnect everything from the phone line, and then run the test again. If the **Dial Tone Detection Test** passes without the other equipment, then one or more pieces of the equipment is causing problems; try adding them back one at a time and rerunning the test each time, until you identify which piece of equipment is causing the problem.
- Try connecting a working phone and phone cord to the telephone wall jack that you are using for the printer and check for a dial tone. If you do not hear a dial tone, contact your telephone company and have them check the line.
- Make sure you have correctly connected the printer to the telephone wall jack. Using the phone cord supplied in the box with the printer, connect one end to your telephone wall jack, then connect the other end to the port labeled 1-LINE on the back of the printer.

- If you are using a phone splitter, this can cause faxing problems. (A splitter is a two-cord connector that plugs into a telephone wall jack.) Try removing the splitter and connecting the printer directly to the telephone wall jack.
- If your telephone system is not using a standard dial tone, such as some private branch exchange (PBX) systems, this might cause the test to fail. This does not cause a problem sending or receiving faxes. Try sending or receiving a test fax.
- Check to make sure the country/region setting is set appropriately for your country/region. If the country/region setting is not set or is set incorrectly, the test might fail and you might have problems sending and receiving faxes.
- Make sure you connect the printer to an analog phone line or you cannot send or receive faxes. To check if your phone line is digital, connect a regular analog phone to the line and listen for a dial tone. If you do not hear a normal sounding dial tone, it might be a phone line set up for digital phones. Connect the printer to an analog phone line and try sending or receiving a fax.
- Make sure you use the phone cord that came with the printer. If you do not use the supplied phone cord to connect from the telephone wall jack to the printer, you might not be able to send or receive faxes. After you plug in the phone cord that came with the printer, run the fax test again.

After you resolve any problems found, run the fax test again to make sure it passes and the printer is ready for faxing. If the **Dial Tone Detection** test continues to fail, contact your telephone company and have them check the phone line.

#### The "Fax Line Condition" test failed

- Make sure you connect the printer to an analog phone line or you cannot send or receive faxes. To check if your phone line is digital, connect a regular analog phone to the line and listen for a dial tone. If you do not hear a normal sounding dial tone, it might be a phone line set up for digital phones. Connect the printer to an analog phone line and try sending or receiving a fax.
- Check the connection between the telephone wall jack and the printer to make sure the phone cord is secure.
- Make sure you have correctly connected the printer to the telephone wall jack. Using the phone cord supplied in the box with the printer, connect one end to your telephone wall jack, then connect the other end to the port labeled 1-LINE on the back of the printer.
- Other equipment, which uses the same phone line as the printer, might be causing the test to fail. To find out if other equipment is causing a problem, disconnect everything from the phone line, and then run the test again.
  - If the **Fax Line Condition Test** passes without the other equipment, then one or more pieces of the equipment is causing problems; try adding them back one at a time and rerunning the test each time, until you identify which piece of equipment is causing the problem.
  - If the **Fax Line Condition Test** fails without the other equipment, connect the printer to a working phone line and continue reviewing the troubleshooting information in this section.
- If you are using a phone splitter, this can cause faxing problems. (A splitter is a two-cord connector that plugs into a telephone wall jack.) Try removing the splitter and connecting the printer directly to the telephone wall jack.
- Make sure you use the phone cord that came with the printer. If you do not use the supplied phone cord to connect from the telephone wall jack to the printer, you might not be able to send

or receive faxes. After you plug in the phone cord that came with the printer, run the fax test again.

After you resolve any problems found, run the fax test again to make sure it passes and the printer is ready for faxing. If the **Fax Line Condition** test continues to fail and you experience problems faxing, contact your telephone company and have them check the phone line.

## Troubleshoot fax problems.

<a href="#">Troubleshoot fax problems.</a>	Use an HP online troubleshooting wizard Resolve problems sending or receiving a fax or faxing to your computer.
--	--



**NOTE:** The HP online troubleshooting wizards may not be available in all languages.



## Read general instructions in the Help for specific fax problems

What kind of fax problem are you having?

### The display always shows Phone Off Hook

- You are using the wrong type of phone cord. Make sure you are using the 2-wire phone cord that came with the printer to connect the printer to your phone line. If the phone cord that came with the printer is not long enough, you can use a longer phone cord to extend the length. You can purchase the cord at an electronics store that carries phone accessories.
- Other equipment that uses the same phone line as the printer might be in use. Make sure extension phones (phones on the same phone line, but not connected to the printer) or other equipment are not in use or off the hook. For example, you cannot use the printer for faxing if an extension phone is off the hook, or if you are using a computer dial-up modem to send email or access the Internet.

### The printer is having problems sending and receiving faxes

- Make sure the printer is turned on. Look at the display on the printer. If the display is blank and  (the Power button) light is not lit, the printer is turned off. Make sure the power cord is firmly connected to the printer and plugged into a power outlet. Press  (the Power button) to turn on the printer.

After turning on the printer, HP recommends you wait five minutes before sending or receiving a fax. The printer cannot send or receive faxes while it is initializing after being turned on.

- If HP Digital Fax has been enabled, you might not be able to send or receive faxes if the fax memory is full (limited by printer memory).

- Make sure you used the phone cord supplied in the box with the printer to connect to the telephone wall jack. One end of the phone cord should be connected to the port labeled 1-LINE on the back of the printer and the other end to your telephone wall jack, as shown in the illustration.

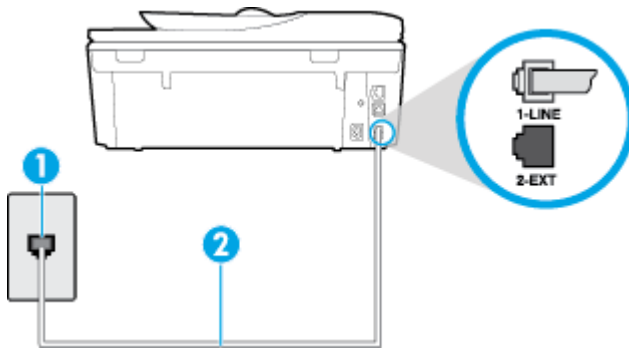

1	Telephone wall jack
2	Use the phone cord supplied in the box with the printer to connect to the "1-LINE" port

If the phone cord that came with the printer is not long enough, you can use a longer 2-wire phone cord to extend the length. You can purchase the cord at an electronics store that carries phone accessories.

- Try connecting a working phone and phone cord to the telephone wall jack that you are using for the printer and check for a dial tone. If you do not hear a dial tone, call your local telephone company for service.
- Other equipment, which uses the same phone line as the printer, might be in use. For example, you cannot use the printer for faxing if an extension phone is off the hook, or if you are using a computer dial-up modem to send an email or access the Internet.
- Check to see if another process has caused an error. Check the display or your computer for an error message providing information about the problem and how to solve it. If there is an error, the printer cannot send or receive a fax until the error condition is resolved.
- The phone line connection might be noisy. Phone lines with poor sound quality (noise) can cause faxing problems. Check the sound quality of the phone line by plugging a phone into the telephone wall jack and listening for static or other noise. If you hear noise, turn **Error Correction Mode (ECM)** off and try faxing again. For information about changing ECM, see [Send a fax in Error Correction Mode on page 53](#). If the problem persists, contact your telephone company.
- If you are using a digital subscriber line (DSL) service, make sure that you have a DSL filter connected or you cannot fax successfully. [Click here to go online for more information](#).
- Make sure the printer is not connected to a telephone wall jack that is set up for digital phones. To check if your phone line is digital, connect a regular analog phone to the line and listen for a dial tone. If you do not hear a normal sounding dial tone, it might be a phone line set up for digital phones.
- If you are using either a private branch exchange (PBX) or an integrated services digital network (ISDN) converter/terminal adapter, make sure the printer is connected to the correct port and the terminal adapter is set to the correct switch type for your country/region, if possible. [Click here to go online for more information](#).

- If the printer shares the same phone line with a DSL service, the DSL modem might not be grounded correctly. If the DSL modem is not grounded correctly, it can create noise on the phone line. Phone lines with poor sound quality (noise) can cause faxing problems. You can check the sound quality of the phone line by plugging a phone into the telephone wall jack and listening for static or other noise. If you hear noise, turn off your DSL modem and completely remove power for at least 15 minutes. Turn the DSL modem back on and listen to the dial tone again.



**NOTE:** You might notice static on the phone line again in the future. If the printer stops sending and receiving faxes, repeat this process.

If the phone line is still noisy, contact your telephone company. For information on turning your DSL modem off, contact your DSL provider for support.

- If you are using a phone splitter, this can cause faxing problems. (A splitter is a two-cord connector that plugs into a telephone wall jack.) Try removing the splitter and connecting the printer directly to the telephone wall jack.

## The printer cannot receive faxes, but can send faxes

- If you are not using a distinctive ring service, check to make sure that the **Distinctive Ring** feature on the printer is set to **All Rings**. For more information, see [Change the answer ring pattern for distinctive ring on page 65](#).
- If **Auto Answer** is set to **Off**, you need to receive faxes manually; otherwise, the printer cannot receive the fax. For information on receiving faxes manually, see [Receive a fax manually on page 55](#).
- If you have a voice mail service at the same phone number you use for fax calls, you must receive faxes manually, not automatically. This means that you must be available to respond in person to incoming fax calls. Learn more about setting up the printer when you have a voice mail service, [click here to go online for more information](#). For information on receiving faxes manually, see [Receive a fax manually on page 55](#).
- If you have a computer dial-up modem on the same phone line with the printer, check to make sure that the software that came with your modem is not set to receive faxes automatically. Modems that are set up to receive faxes automatically take over the phone line to receive all incoming faxes, which prevents the printer from receiving fax calls.
- If you have an answering machine on the same phone line with the printer, you might have one of the following problems:
  - Your answering machine might not be set up correctly with the printer.
  - Your outgoing message might be too long or too loud to allow the printer to detect fax tones, and the sending fax machine might disconnect.
  - Your answering machine might not have enough quiet time after your outgoing message to allow the printer to detect fax tones. This problem is most common with digital answering machines.

The following actions might help solve these problems:

- When you have an answering machine on the same phone line you use for fax calls, try connecting the answering machine directly to the printer, [click here to go online for more information](#).
- Make sure the printer is set to receive faxes automatically. For information on setting up the printer to receive faxes automatically, see [Receive a fax on page 55](#).
- Make sure the **Rings to Answer** setting is set to a greater number of rings than the answering machine. For more information, see [Set the number of rings before answering on page 65](#).
- Disconnect the answering machine and then try receiving a fax. If faxing is successful without the answering machine, the answering machine might be causing the problem.
- Reconnect the answering machine and record your outgoing message again. Record a message that is approximately 10 seconds in duration. Speak slowly and at a low volume when recording your message. Leave at least 5 seconds of silence at the end of the voice message. There should be no background noise when recording this silent time. Try to receive a fax again.



**NOTE:** Some digital answering machines might not retain the recorded silence at the end of your outgoing message. Play back your outgoing message to check.

- If the printer shares the same phone line with other types of phone equipment, such as an answering machine, a computer dial-up modem, or a multi-port switch box, the fax signal level might be reduced. The signal level can also be reduced if you use a splitter or connect extra cables to extend the length of your phone. A reduced fax signal can cause problems during fax reception.

To find out if other equipment is causing a problem, disconnect everything except the printer from the phone line, and then try to receive a fax. If you can receive faxes successfully without the other equipment, one or more pieces of the other equipment is causing problems; try adding them back one at a time and receiving a fax each time, until you identify which equipment is causing the problem.

- If you have a special ring pattern for your fax phone number (using a distinctive ring service through your telephone company), make sure that the **Distinctive Ring** feature on the printer is set to match. For more information, see [Change the answer ring pattern for distinctive ring on page 65](#).

## The printer cannot send faxes, but can receive faxes

- The printer might be dialing too fast or too soon. You might need to insert some pauses in the number sequence. For example, if you need to access an outside line before dialing the phone number, insert a pause following the access number. If your number is 95555555, and 9 accesses an outside line, you might insert pauses as follows: 9-555-5555. To enter a pause in the fax number you are typing, touch the \* repeatedly, until a dash (-) appears on the display.

You can also send the fax using monitor dialing. This enables you to listen to the phone line as you dial. You can set the pace of your dialing and respond to prompts as you dial. For more information, see [Send a fax using monitor dialing on page 52](#).

- The number you entered when sending the fax is not in the proper format or the receiving fax machine is having problems. To check this, try calling the fax number from a telephone and listen for fax tones. If you cannot hear fax tones, the receiving fax machine might not be turned on or connected, or a voice mail service could be interfering with the recipient's phone line. You can also ask the recipient to check the receiving fax machine for any problems.



## Fax tones are recorded on my answering machine

- When you have an answering machine on the same phone line you use for fax calls, try connecting the answering machine directly to the printer, [click here to go online for more information](#). If you do not connect the answering machine as recommended, fax tones might be recorded on your answering machine.
- Make sure the printer is set to receive faxes automatically and that the **Rings to Answer** setting is correct. The number of rings to answer for the printer should be greater than the number of rings to answer for the answering machine. If the answering machine and the printer are set to the same number of rings to answer, both devices answer the call and fax tones are recorded on the answering machine.
- Set your answering machine to a low number of rings and the printer to answer in the maximum number of rings supported. (The maximum number of rings varies by country/region.) In this setup, the answering machine answers the call and the printer monitors the line. If the printer detects fax tones, the printer receives the fax. If the call is a voice call, the answering machine records the incoming message. For more information, see [Set the number of rings before answering on page 65](#).

## The computer cannot receive faxes (HP Digital Fax)

- The computer selected to receive faxes is turned off. Make sure the computer selected to receive faxes is switched on at all times.
- Different computers are configured for setup and receiving faxes and one of them may be switched off. If the computer receiving faxes is different from the one used for setup, both computers should be switched on at all times.
- HP Digital Fax is not activated or the computer is not configured to receive faxes. Activate HP Digital Fax and make sure the computer is configured to receive faxes.

# Network and connection issues

What do you want to do?

## Fix wireless connection



Choose one of the following troubleshooting options.

<a href="#">HP Print and Scan Doctor</a>	The HP Print and Scan Doctor is a utility that will try to diagnose and fix the issue automatically.
Use an HP online troubleshooting wizard	<ul style="list-style-type: none"><li>• <a href="#">Troubleshoot your wireless problem</a>, whether your printer has never been connected or it was connected and is no longer working.</li><li>• <a href="#">Troubleshoot a firewall or antivirus issue</a>, if you suspect that it is preventing your computer from connecting to the printer.</li></ul>

 **NOTE:** The HP Print and Scan Doctor and the HP online troubleshooting wizards may not be available in all languages.

### Read general instructions in the Help for wireless troubleshooting

Check the network configuration or print the wireless test report to assist in diagnosing network connection issues.

1. From the Home screen, touch  (**Wireless**) and then touch  (**Settings**).
2. Touch **Print Reports**. and then touch **Display Network Configuration** or **Print Wireless Test Report**.

## Find network settings for wireless connection

Choose one of the following troubleshooting options.

<a href="#">HP Print and Scan Doctor</a>	The HP Print and Scan Doctor is a utility that can tell you the network name (SSID) and password (network key).
<a href="#">Use an HP online troubleshooting wizard</a>	Learn how to find your network name (SSID) and wireless password.

 **NOTE:** The HP Print and Scan Doctor and the HP online troubleshooting wizards may not be available in all languages.

## Fix Wi-Fi Direct connection

<a href="#">Use an HP online troubleshooting wizard</a>	Troubleshoot your Wi-Fi Direct problem or learn how to configure Wi-Fi Direct.
---	--

 **NOTE:** The HP online troubleshooting wizards may not be available in all languages.

### Read general instructions in the Help for Wi-Fi Direct troubleshooting

1. Check the printer to confirm that Wi-Fi Direct is turned on:

- a. From the printer control panel, touch  (Wi-Fi Direct).
- b. If **Status** is **Off**, touch  (**Wi-Fi Direct Settings**) and turn Wi-Fi Direct on.
2. From your wireless computer or mobile device, turn on the Wi-Fi connection, and then search for and connect to the Wi-Fi Direct name of your printer.
3. Enter the Wi-Fi Direct password when prompted.
4. If you are using a mobile device, make sure you have installed a compatible printing app. For more information about mobile printing, visit [www.hp.com/global/us/en/eprint/mobile\\_printing\\_apps.html](http://www.hp.com/global/us/en/eprint/mobile_printing_apps.html).

## Convert USB connection to wireless

Choose one of the following troubleshooting options.

<a href="#">HP Print and Scan Doctor</a>	The HP Print and Scan Doctor is a utility that will try to diagnose and fix the issue automatically.
<a href="#">Use an HP online troubleshooting wizard</a>	Convert a USB connection to wireless or Wi-Fi Direct.

 **NOTE:** The HP Print and Scan Doctor and the HP online troubleshooting wizards may not be available in all languages.

[Change the connection type on page 85](#)

## Fix Ethernet connection

Check the following:

- The network is operational and the network hub, switch, or router is turned on.
- The Ethernet cable is plugged into the printer properly and the Ethernet light near the connector is turned on.
- Antivirus programs, including spyware protection programs, are not impacting your network connection to the printer. If you know that antivirus or firewall software is preventing your computer from connecting to the printer, [use the HP online firewall troubleshooter](#) to help solve the problem.
- [HP Print and Scan Doctor](#)

Run the HP Print and Scan Doctor to troubleshoot the issue automatically. The utility will try to diagnose and fix the issue. The HP Print and Scan Doctor may not be available in all languages.

# Printer hardware issues

## To extract the automatic output tray extender manually

If the automatic output tray extender does not deploy automatically, you can extract it manually.

1. Remove the output tray from the printer.



2. On the bottom of the output tray, move the output tray lock to the unlocked position, and then shift the release lever to release the tray extender.

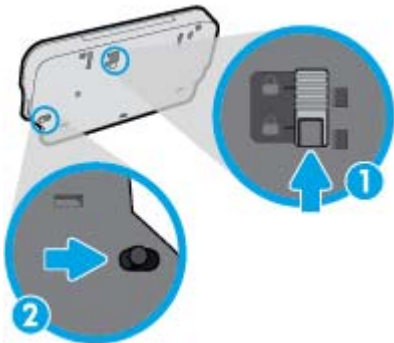

3. Insert the output tray back into the printer leaving the tray extender in the released position.

## The printer shuts down unexpectedly

- Check the power and power connections.
- Make sure the printer's power cord is connected firmly to a functioning power outlet.

## Printhead alignment fails

- If the alignment process fails, make sure you have loaded unused, plain white paper into the input tray. If you have colored paper loaded in the input tray when you align the ink cartridges, the alignment fails.
- If the alignment process fails repeatedly, you may need to clean the printhead, or you might have a defective sensor.
- If cleaning the printhead does not solve the problem, contact HP support. Go to [www.hp.com/support](http://www.hp.com/support). This website provides information and utilities that can help you correct many common printer problems. If prompted, select your country/region, and then click **All HP Contacts** for information on calling for technical support.

### Resolve printer failure.

- ▲ Turn the printer off, then on. If that does not resolve the problem, contact HP.

For more information about contacting HP support, see [HP support on page 128](#).

# HP support

- [Register printer](#)
- [Support process](#)
- [HP support by phone](#)
- [Additional warranty options](#)

## Register printer

By taking just a few quick minutes to register, you can enjoy quicker service, more efficient support, and product support alerts. If you did not register your printer while installing the software, you can register now at <http://www.register.hp.com>.

## Support process

If you have a problem, follow these steps:

1. Check the documentation that came with the printer.
2. Visit the HP online support website at [www.hp.com/support](http://www.hp.com/support).

HP online support is available to all HP customers. It is the fastest source for up-to-date product information and expert assistance, and includes the following features:

- Fast access to qualified online support specialists
  - Software and driver updates for the printer
  - Valuable troubleshooting information for common problems
  - Proactive printer updates, support alerts, and HP newsgrams that are available when you register the printer
3. Call HP support.

Support options and availability vary by printer, country/region, and language.

## HP support by phone

Phone support options and availability vary by product, country/region, and language.

This section contains the following topics:

- [Phone support period](#)
- [Placing a call](#)
- [Support phone numbers](#)
- [After the phone support period](#)

## Phone support period

One year of phone support is available in North America, Asia Pacific, and Latin America (including Mexico). To determine the duration of phone support in Europe, the Middle East, and Africa, go to [www.hp.com/support](http://www.hp.com/support). Standard phone company charges apply.

## Placing a call

Call HP support while you are in front of the computer and the printer. Be prepared to provide the following information:

- Product name (Located on the printer, such as HP Officejet 8040)
- Product number (located inside the cartridge access door)



- Serial number (located on the back or bottom of the printer)
- Messages that appear when the situation occurs
- Answers to these questions:
  - Has this situation happened before?
  - Can you recreate it?
  - Did you add any new hardware or software to your computer at about the time that this situation began?
  - Did anything else occur prior to this situation (such as a thunderstorm, the printer was moved, etc.)?

## Support phone numbers

For the most current HP list of telephone support numbers and call costs information, see [www.hp.com/support](http://www.hp.com/support).

## After the phone support period

After the phone support period, help is available from HP at an additional cost. Help may also be available at the HP online support website: [www.hp.com/support](http://www.hp.com/support). Contact your HP dealer or call the support phone number for your country/region to learn more about support options.

## Additional warranty options

Extended service plans are available for the HP Officejet 8040 series at additional costs. Go to [www.hp.com/support](http://www.hp.com/support), select your country/region and language, then explore the services and warranty area for information about the extended service plans.

---

# A Technical information

The technical specifications and international regulatory information for the HP Officejet 8040 series are provided in this section.

For additional specifications, see the printed documentation that came with the HP Officejet 8040 series.

This section contains the following topics:

- [Hewlett-Packard Company notices](#)
- [Specifications](#)
- [Environmental product stewardship program](#)
- [Regulatory information](#)



# Hewlett-Packard Company notices

The information contained herein is subject to change without notice.

All rights reserved. Reproduction, adaptation, or translation of this material is prohibited without prior written permission of Hewlett-Packard, except as allowed under the copyright laws. The only warranties for HP products and services are set forth in the express warranty statements accompanying such products and services. Nothing herein should be construed as constituting an additional warranty. HP shall not be liable for technical or editorial errors or omissions contained herein.

© 2014 Hewlett-Packard Development Company, L.P.

Microsoft®, Windows®, Windows® XP, Windows Vista®, Windows® 7, Windows® 8, and Windows® 8.1 are U.S. registered trademarks of Microsoft Corporation.

# Specifications

Technical specifications for the HP Officejet 8040 series are provided in this section. For more product specifications, see the Product Data Sheet at [www.hp.com/support](http://www.hp.com/support).

- [System requirements](#)
- [Environmental specifications](#)
- [Print specifications](#)
- [Scan specifications](#)
- [Copy specifications](#)
- [Cartridge yield](#)
- [Print resolution](#)

## System requirements

Software and system requirements are located in the Readme file.

For information about future operating system releases and support, visit the HP online support website at [www.hp.com/support](http://www.hp.com/support).

## Environmental specifications

- Recommended operating temperature range: 15°C to 32°C (59°F to 90°F)
- Allowable operating temperature range: 5°C to 40°C (41°F to 104°F)
- Humidity: 20% to 80% RH non-condensing (recommended); 25°C maximum dewpoint
- Non-operating (Storage) temperature range: -40°C to 60°C (-40°F to 140°F)
- In the presence of high electromagnetic fields, it is possible the output from the HP Officejet 8040 series may be slightly distorted.
- HP recommends using a USB cable less than or equal to 3 m (10 feet) in length to minimize injected noise due to potential high electromagnetic fields.

## Print specifications

- Print speeds vary according to the complexity of the document.
- Method: drop-on-demand thermal inkjet
- Language: PCL3 GUI

## Scan specifications

- Optical Resolution: up to 1200 dpi
- Hardware Resolution: up to 1200 x 1200 dpi
- Enhanced Resolution: up to 1200 x 1200 dpi

- Bitdepth: 24-bit color, 8-bit grayscale (256 levels of gray)
- Maximum scan size from glass: 21.6 x 29.7 cm (8.5 x 11.7 inches)
- Supported File Types: BMP, JPEG, PNG, TIFF, PDF
- Twain Version: 1.9

## Copy specifications

- Digital image processing
- Maximum number of copies varies by model.
- Copy speeds vary according to the complexity of the document and model.

## Cartridge yield

Visit [www.hp.com/go/learnaboutsupplies](http://www.hp.com/go/learnaboutsupplies) for more information on estimated cartridge yields.

## Print resolution

**Table A-1 Print resolution**

<b>Draft mode</b>	<ul style="list-style-type: none"> <li>• Color Input/Black Render: 300x300dpi</li> <li>• Output (Black/Color): Automatic</li> </ul>
<b>Normal mode</b>	<ul style="list-style-type: none"> <li>• Color Input/Black Render: 600x600dpi</li> <li>• Output (Black/Color): Automatic</li> </ul>
<b>Plain-Best mode</b>	<ul style="list-style-type: none"> <li>• Color Input/Black Render: 600x600dpi</li> <li>• Output (Black/Color): Automatic</li> </ul>
<b>Photo-Best mode</b>	<ul style="list-style-type: none"> <li>• Color Input/Black Render: 600x600dpi</li> <li>• Output (Black/Color): Automatic</li> </ul>
<b>Max DPI mode</b>	<ul style="list-style-type: none"> <li>• Color Input/Black Render: 1200x1200dpi</li> <li>• Output: Automatic (Black/Color), 4800x1200 optimized dpi (Photo Paper, Color)</li> </ul>

# Environmental product stewardship program

Hewlett-Packard is committed to providing quality products in an environmentally sound manner. Design for recycling has been incorporated into this product. The number of materials has been kept to a minimum while ensuring proper functionality and reliability. Dissimilar materials have been designed to separate easily. Fasteners and other connections are easy to locate, access, and remove using common tools. High priority parts are designed for efficient disassembly and repair.

For more information, visit HP's Commitment to the Environment website at:

[www.hp.com/hpinfo/globalcitizenship/environment/index.html](http://www.hp.com/hpinfo/globalcitizenship/environment/index.html).

This section contains the following topics:

- [Eco-Tips](#)
- [Paper use](#)
- [Plastics](#)
- [Material safety data sheets](#)
- [Recycling program](#)
- [HP inkjet supplies recycling program](#)
- [Power consumption](#)
- [Disposal of waste equipment by users](#)
- [California Perchlorate Material Notice](#)
- [EPEAT](#)

## Eco-Tips

HP is committed to helping customers reduce their environmental footprint. Please visit the HP Environmental Programs and Initiatives website for more information on HP's environmental initiatives.

[www.hp.com/hpinfo/globalcitizenship/environment/](http://www.hp.com/hpinfo/globalcitizenship/environment/)

## Paper use

This product is suited for the use of recycled paper according to DIN 19309 and EN 12281:2002.

## Plastics

Plastic parts over 25 grams are marked according to international standards that enhance the ability to identify plastics for recycling purposes at the end of product life.

## Material safety data sheets

Material safety data sheets (MSDS) can be obtained from the HP website at:

[www.hp.com/go/msds](http://www.hp.com/go/msds)

## Recycling program

HP offers an increasing number of product return and recycling programs in many countries/regions, and partners with some of the largest electronic recycling centers throughout the world. HP conserves resources by reselling some of its most popular products. For more information regarding recycling of HP products, please visit:

[www.hp.com/recycle](http://www.hp.com/recycle)

## HP inkjet supplies recycling program

HP is committed to protecting the environment. The HP Inkjet Supplies Recycling Program is available in many countries/regions, and lets you recycle used print cartridges and ink cartridges free of charge. For more information, go to the following website:

[www.hp.com/hpinfo/globalcitizenship/environment/recycle/](http://www.hp.com/hpinfo/globalcitizenship/environment/recycle/)

## Power consumption

Hewlett-Packard printing and imaging equipment marked with the ENERGY STAR® logo is qualified to the U.S. Environmental Protection Agency's ENERGY STAR specifications for imaging equipment. The following mark will appear on ENERGY STAR qualified imaging products:



Additional ENERGY STAR qualified imaging product model information is listed at: [www.hp.com/go/energystar](http://www.hp.com/go/energystar)

## Disposal of waste equipment by users



This symbol means do not dispose of your product with your other household waste. Instead, you should protect human health and the environment by handing over your waste equipment to a designated collection point for the recycling of waste electrical and electronic equipment. For more information, please contact your household waste disposal service, or go to <http://www.hp.com/recycle>.

## California Perchlorate Material Notice

### **California Perchlorate Material Notice**

Perchlorate material - special handling may apply. See:  
<http://www.dtsc.ca.gov/hazardouswaste/perchlorate/>

This product's real-time clock battery or coin cell battery may contain perchlorate and may require special handling when recycled or disposed of in California.

## EPEAT

### **EPEAT**

Most HP products are designed to meet EPEAT. EPEAT is a comprehensive environmental rating that helps identify greener electronics equipment. For more information on EPEAT go to [www.epeat.net](http://www.epeat.net). For information on HP's EPEAT registered products go to [www.hp.com/hpinfo/globalcitizenship/environment/pdf/epeat\\_printers.pdf](http://www.hp.com/hpinfo/globalcitizenship/environment/pdf/epeat_printers.pdf).

# Regulatory information

The printer meets product requirements from regulatory agencies in your country/region.

This section contains the following topics:

- [Regulatory model identification number](#)
- [FCC statement](#)
- [Notice to users of the U.S. telephone network: FCC requirements](#)
- [Declaration of conformity](#)
- [Regulatory information for wireless products](#)

## Regulatory model identification number

For regulatory identification purposes, your product is assigned a Regulatory Model Number. The Regulatory Model Number for your product is SDGOB-1401-03. This regulatory number should not be confused with the marketing name (HP Officejet 8040 e-All-in-One series, etc.) or product numbers (F5A16-F5A19, etc.).

## FCC statement

### FCC statement

The United States Federal Communications Commission (in 47 CFR 15.105) has specified that the following notice be brought to the attention of users of this product.

This equipment has been tested and found to comply with the limits for a Class B digital device, pursuant to Part 15 of the FCC Rules. These limits are designed to provide reasonable protection against harmful interference in a residential installation. This equipment generates, uses and can radiate radio frequency energy and, if not installed and used in accordance with the instructions, may cause harmful interference to radio communications. However, there is no guarantee that interference will not occur in a particular installation. If this equipment does cause harmful interference to radio or television reception, which can be determined by turning the equipment off and on, the user is encouraged to try to correct the interference by one or more of the following measures:

- Reorient or relocate the receiving antenna.
- Increase the separation between the equipment and the receiver.
- Connect the equipment into an outlet on a circuit different from that to which the receiver is connected.
- Consult the dealer or an experienced radio/TV technician for help.

For further information, contact:

Manager of Corporate Product Regulations  
Hewlett-Packard Company  
3000 Hanover Street  
Palo Alto, Ca 94304  
(650) 857-1501

Modifications (part 15.21)

The FCC requires the user to be notified that any changes or modifications made to this device that are not expressly approved by HP may void the user's authority to operate the equipment.

This device complies with Part 15 of the FCC Rules. Operation is subject to the following two conditions: (1) this device may not cause harmful interference, and (2) this device must accept any interference received, including interference that may cause undesired operation.

## Notice to users of the U.S. telephone network: FCC requirements

### Notice to users of the U.S Telephone network: FCC requirements

This equipment complies with Part 68 of the FCC rules and the requirements adopted by the ACTA. On the rear (or bottom) of this equipment is a label that contains, among other information, a product identifier in the format US:AAAEQ##TXXXX. If requested, this number must be provided to the telephone company.

Applicable connector jack Universal Service Order Codes ("USOC") for the Equipment is: RJ-11C.

A plug and jack used to connect this equipment to the premises wiring and telephone network must comply with the applicable FCC Part 68 rules and requirements adopted by the ACTA. A compliant telephone cord and modular plug is provided with this product. It is designed to be connected to a compatible modular jack that is also compliant. See installation instructions for details.

The REN is used to determine the number of devices that may be connected to a telephone line. Excessive RENs on a telephone line may result in the devices not ringing in response to an incoming call. In most but not all areas, the sum of RENs should not exceed five (5.0). To be certain of the number of devices that may be connected to a line, as determined by the total RENs, contact the local telephone company. For products approved after July 23, 2001, the REN for this product is part of the product identifier that has the format US:AAAEQ##TXXXX. The digits represented by ## are the REN without a decimal point (e.g., 00 is a REN of 0.0).

If this equipment causes harm to the telephone network, the telephone company will notify you in advance that temporary discontinuance of service may be required. But if advance notice isn't practical, the telephone company will notify the customer as soon as possible. Also, you will be advised of your right to file a complaint with the FCC if you believe it is necessary.

The telephone company may make changes in its facilities, equipment, operations or procedures that could affect the operation of the equipment. If this happens the telephone company will provide advance notice in order for you to make necessary modifications to maintain uninterrupted service.

If trouble is experienced with this equipment, please contact the manufacturer, or look elsewhere in this manual, for repair or warranty information. If the equipment is causing harm to the telephone network, the telephone company may request that you disconnect the equipment until the problem is resolved.

Connection to party line service is subject to state tariffs. Contact the state public utility commission, public service commission or corporation commission for information.

If your home has specially wired alarm equipment connected to the telephone line, ensure the installation of this equipment does not disable your alarm equipment. If you have questions about what will disable alarm equipment, consult your telephone company or a qualified installer.

WHEN PROGRAMMING EMERGENCY NUMBERS AND/OR MAKING TEST CALLS TO EMERGENCY NUMBERS:

- 1) Remain on the line and briefly explain to the dispatcher the reason for the call.
- 2) Perform such activities in the off-peak hours, such as early morning or late evenings.



**Note** The FCC hearing aid compatibility rules for telephones are not applicable to this equipment.

The Telephone Consumer Protection Act of 1991 makes it unlawful for any person to use a computer or other electronic device, including FAX machines, to send any message unless such message clearly contains in a margin at the top or bottom of each transmitted page or on the first page of the transmission, the date and time it is sent and an identification of the business or other entity, or other individual sending the message and the telephone number of the sending machine or such business, other entity, or individual. (The telephone number provided may not be a 900 number or any other number for which charges exceed local or long-distance transmission charges.)

In order to program this information into your FAX machine, you should complete the steps described in the software.



## Declaration of conformity



### DECLARATION OF CONFORMITY

according to ISO 17050-1

**DoC #: SDG0B-1401-03**

**Supplier's Name:** Hewlett-Packard Company  
**Supplier's Address:** 16399 West Bernardo Drive, San Diego, CA 92127-1899, USA  
**declares, that the product**  
**Product Name and Model:**<sup>2)</sup> HP ENVY 8000 e-All-in-One Printer  
HP Officejet 8040 e-All-in-One Printer  
**Regulatory Model Number:**<sup>1)</sup> SDG0B-1401-03  
**Product Options:** All  
**Radio Module:** SDG0B-1392 (802.11 b/g/n)  
**Power Adapter:** N/A

**conforms to the following Product Specifications and Regulations:**

**EMC:** Class B  
FCC CFR 47 Part 15

**Safety:**  
IEC 60950-1: 2005 + A1: 2009

**Telecom:**  
FCC Rules and Regulations 47 CFR Part 68, TIA-968-B, TIA-1096-A

This device complies with part 15 of the FCC Rules. Operation is subject to the following two conditions:

(1) This device may not cause harmful interference, and (2) this device must accept any interference received, including interference that may cause undesired operation.

#### **Additional Information:**

- 1) This product is assigned a Regulatory Model Number which stays with the regulatory aspects of the design. The Regulatory Model Number is the main product identifier in the regulatory documentation and test reports, this number should not be confused with the marketing name or the product numbers.

**February 2014**  
San Diego, CA

#### **Local contact for regulatory topics only:**

U.S.: Hewlett-Packard, 3000 Hanover St., Palo Alto, CA 94304, U.S.A. 650-857-1501

## Regulatory information for wireless products

This section contains the following regulatory information pertaining to wireless products:

- [Exposure to radio frequency radiation](#)

## Exposure to radio frequency radiation

### Exposure to radio frequency radiation



**Caution** The radiated output power of this device is far below the FCC radio frequency exposure limits. Nevertheless, the device shall be used in such a manner that the potential for human contact during normal operation is minimized. This product and any attached external antenna, if supported, shall be placed in such a manner to minimize the potential for human contact during normal operation. In order to avoid the possibility of exceeding the FCC radio frequency exposure limits, human proximity to the antenna shall not be less than 20 cm (8 inches) during normal operation.

---

## B Additional fax setup

After completing all the steps in the getting started guide, use the instructions in this section to complete your fax setup. Keep your getting started guide for later use.

In this section, you learn how to set up the printer so that faxing works successfully with equipment and services you might already have on the same phone line.

---

 **TIP:** You can also use the Fax Setup Wizard (Windows) or HP Utility (OS X) to help you quickly set up some important fax settings such as the answer mode and fax header information. You can access these tools through the HP software you installed with the printer. After you run these tools, follow the procedures in this section to complete your fax setup.

---

This section contains the following topics:

- [Set up faxing \(parallel phone systems\)](#)
- [Serial-type fax setup](#)
- [Test fax setup](#)

## Set up faxing (parallel phone systems)

Before you begin setting up the printer for faxing, determine which kind of phone system your country/region uses. The instructions for fax setup differ depending on whether you have a serial- or parallel-type phone system.

- If you do not see your country/region listed in the table, you probably have a serial-type phone system. In a serial-type phone system, the connector type on your shared telephone equipment (modems, phones, and answering machines) does not allow a physical connection to the "2-EXT" port on the printer. Instead, all equipment must be connected at the telephone wall jack.

 **NOTE:** In some countries/regions that use serial-type phone systems, the phone cord that came with the printer might have an additional wall plug attached to it. This enables you to connect other telecom devices to the wall jack where you plug in the printer.

You might need to connect the supplied phone cord to the adapter provided for your country/region.

- If your country/region is listed in the table, you probably have a parallel-type telephone system. In a parallel-type phone system, you are able to connect shared telephone equipment to the phone line by using the "2-EXT" port on the back of the printer.

 **NOTE:** If you have a parallel-type phone system, HP recommends you use the 2-wire phone cord supplied with the printer to connect it to the telephone wall jack.

**Table B-1** Countries/regions with a parallel-type phone system

Argentina	Australia	Brazil
Canada	Chile	China
Colombia	Greece	India
Indonesia	Ireland	Japan
Korea	Latin America	Malaysia
Mexico	Philippines	Poland
Portugal	Russia	Saudi Arabia
Singapore	Spain	Taiwan
Thailand	USA	Venezuela
Vietnam		

If you are unsure which kind of telephone system you have (serial or parallel), check with your telephone company.

This section contains the following topics:

- [Select the correct fax setup for your home or office](#)
- [Case A: Separate fax line \(no voice calls received\)](#)
- [Case B: Set up the printer with DSL](#)
- [Case C: Set up the printer with a PBX phone system or an ISDN line](#)

- [Case D: Fax with a distinctive ring service on the same line](#)
- [Case E: Shared voice/fax line](#)
- [Case F: Shared voice/fax line with voice mail](#)
- [Case G: Fax line shared with computer modem \(no voice calls received\)](#)
- [Case H: Shared voice/fax line with computer modem](#)
- [Case I: Shared voice/fax line with answering machine](#)
- [Case J: Shared voice/fax line with computer modem and answering machine](#)
- [Case K: Shared voice/fax line with computer dial-up modem and voice mail](#)

## Select the correct fax setup for your home or office

To fax successfully, you need to know what types of equipment and services (if any) share the same phone line with the printer. This is important because you might need to connect some of your existing office equipment directly to the printer, and you might also need to change some fax settings before you can fax successfully.

1. Determine if your telephone system is serial or parallel.

For more information, see [Set up faxing \(parallel phone systems\) on page 142](#).

- a. Serial-type telephone system—See [Serial-type fax setup on page 165](#).
  - b. Parallel-type telephone system—Go to step 2.
2. Select the combination of equipment and services sharing your fax line.
    - DSL: A Digital subscriber line (DSL) service through your telephone company. (DSL might be called ADSL in your country/region.)
    - PBX: A private branch exchange (PBX) phone system.
    - ISDN: An integrated services digital network (ISDN) system.
    - Distinctive ring service: A distinctive ring service through your telephone company provides multiple telephone numbers with different ring patterns.
    - Voice calls: Voice calls are received at the same phone number you use for fax calls on the printer.
    - Computer dial-up modem: A computer dial-up modem is on the same phone line as the printer. If you answer Yes to any of the following questions, you are using a computer dial-up modem:
      - Do you send and receive faxes directly to and from your computer software applications through a dial-up connection?
      - Do you send and receive email messages on your computer through a dial-up connection?
      - Do you access the Internet from your computer through a dial-up connection?

- Answering machine: An answering machine that answers voice calls at the same phone number you use for fax calls on the printer.
- Voice mail service: A voice mail subscription through your telephone company at the same number you use for fax calls on the printer.

3. From the following table, select the combination of equipment and services applicable to your home or office setting. Then look up the recommended fax setup. Step-by-step instructions are included for each case in the sections that follow.



**NOTE:** If your home or office setup is not described in this section, set up the printer as you would a regular analog phone. Make sure you use the phone cord supplied in the box to connect one end to your telephone wall jack and the other end to the port labeled 1-LINE on the back of the printer. If you use another phone cord, you might experience problems sending and receiving faxes.

You might need to connect the supplied phone cord to the adapter provided for your country/region.

Other equipment or services sharing your fax line							Recommended fax setup
DSL	PBX	Distinctive ring service	Voice calls	Computer dial-up modem	Answering machine	Voice mail service	
							<a href="#">Case A: Separate fax line (no voice calls received) on page 145</a>
✓							<a href="#">Case B: Set up the printer with DSL on page 146</a>
	✓						<a href="#">Case C: Set up the printer with a PBX phone system or an ISDN line on page 147</a>
		✓					<a href="#">Case D: Fax with a distinctive ring service on the same line on page 148</a>
			✓				<a href="#">Case E: Shared voice/fax line on page 149</a>
			✓			✓	<a href="#">Case F: Shared voice/fax line with voice mail on page 150</a>
				✓			<a href="#">Case G: Fax line shared with computer modem (no voice calls received) on page 151</a>
			✓	✓			<a href="#">Case H: Shared voice/fax line with computer modem on page 153</a>
			✓		✓		<a href="#">Case I: Shared voice/fax line with answering machine on page 157</a>

Other equipment or services sharing your fax line							Recommended fax setup
DSL	PBX	Distinctive ring service	Voice calls	Computer dial-up modem	Answering machine	Voice mail service	
			✓	✓	✓		<a href="#">Case J: Shared voice/fax line with computer modem and answering machine on page 158</a>
			✓	✓		✓	<a href="#">Case K: Shared voice/fax line with computer dial-up modem and voice mail on page 162</a>

## Case A: Separate fax line (no voice calls received)

If you have a separate phone line on which you receive no voice calls, and you have no other equipment connected on this phone line, set up the printer as described in this section.

**Figure B-1** Back view of the printer

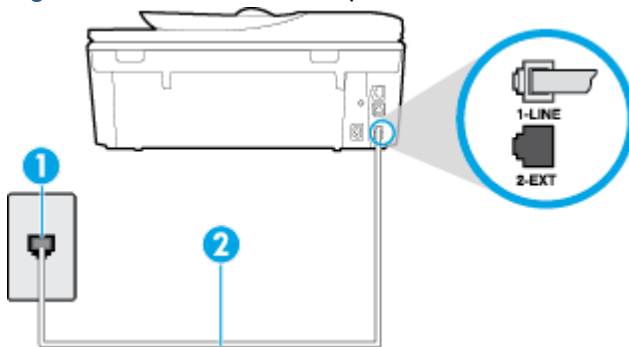

1	Telephone wall jack
2	Use the phone cord supplied in the box with the printer to connect to the 1-LINE port.  You might need to connect the supplied phone cord to the adapter provided for your country/region.

### To set up the printer with a separate fax line

- Using the phone cord supplied in the box with the printer, connect one end to your telephone wall jack, then connect the other end to the port labeled 1-LINE on the back of the printer.

**NOTE:** You might need to connect the supplied phone cord to the adapter provided for your country/region.

If you do not use the supplied cord to connect from the telephone wall jack to the printer, you might not be able to fax successfully. This special phone cord is different from the phone cords you might already have in your home or office.

- Turn on the **Auto Answer** setting.
- (Optional) Change the **Rings to Answer** setting to the lowest setting (two rings).
- Run a fax test.

When the phone rings, the printer answers automatically after the number of rings you set in the **Rings to Answer** setting. The printer begins emitting fax reception tones to the sending fax machine and receives the fax.

## Case B: Set up the printer with DSL

If you have a DSL service through your telephone company, and do not connect any equipment to the printer, use the instructions in this section to connect a DSL filter between the telephone wall jack and the printer. The DSL filter removes the digital signal that can interfere with the printer, so the printer can communicate correctly with the phone line. (DSL might be called ADSL in your country/region.)

 **NOTE:** If you have a DSL line and you do not connect the DSL filter, you cannot send and receive faxes with the printer.

**Figure B-2** Back view of the printer

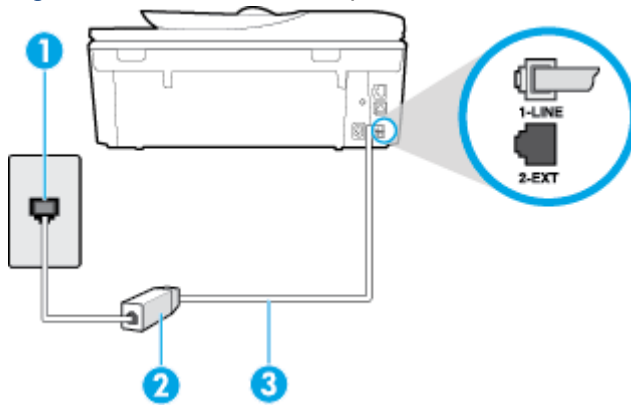

1	Telephone wall jack
2	DSL (or ADSL) filter and cord supplied by your DSL provider
3	Use the phone cord supplied in the box with the printer to connect to the 1-LINE port.  You might need to connect the supplied phone cord to the adapter provided for your country/region.

### To set up the printer with DSL

1. Obtain a DSL filter from your DSL provider.
2. Using the phone cord supplied in the box with the printer, connect one end to the open port on the DSL filter, and then connect the other end to the port labeled 1-LINE on the back of the printer.

 **NOTE:** You might need to connect the supplied phone cord to the adapter provided for your country/region.

If you do not use the supplied cord to connect from the DSL filter to the printer, you might not be able to fax successfully. This special phone cord is different from the phone cords you might already have in your home or office.

As only one phone cord is supplied, you might need to obtain additional phone cords for this setup.



3. Connect an additional phone cord from the DSL filter to the telephone wall jack.
4. Run a fax test.

If you encounter problems setting up the printer with optional equipment, contact your local service provider or vendor for further assistance.

## Case C: Set up the printer with a PBX phone system or an ISDN line

If you are using either a PBX phone system or an ISDN converter/terminal adapter, make sure you do the following:

- If you are using either a PBX or an ISDN converter/terminal adaptor, connect the printer to the port that is designated for fax and phone use. Also, make sure that the terminal adapter is set to the correct switch type for your country/region, if possible.

---

 **NOTE:** Some ISDN systems allow you to configure the ports for specific phone equipment. For example, you might have assigned one port for telephone and Group 3 fax and another port for multiple purposes. If you have problems when connected to the fax/phone port of your ISDN converter, try using the port designated for multiple purposes; it might be labeled "multi-combi" or something similar.

---

- If you are using a PBX phone system, set the call waiting tone to "off."

---

 **NOTE:** Many digital PBX systems include a call-waiting tone that is set to "on" by default. The call waiting tone interferes with any fax transmission, and you cannot send or receive faxes with the printer. Refer to the documentation that came with your PBX phone system for instructions on how to turn off the call-waiting tone.

---

- If you are using a PBX phone system, dial the number for an outside line before dialing the fax number.
- Make sure you use the supplied cord to connect from the telephone wall jack to the printer. If you do not, you might not be able to fax successfully. This special phone cord is different from the phone cords you might already have in your home or office. If the supplied phone cord is too short, you can purchase a longer 2-wire phone cord from your local electronics store and extend it.

You might need to connect the supplied phone cord to the adapter provided for your country/region.

If you encounter problems setting up the printer with optional equipment, contact your local service provider or vendor for further assistance.

## Case D: Fax with a distinctive ring service on the same line

If you subscribe to a distinctive ring service (through your telephone company) that allows you to have multiple phone numbers on one phone line, each with a different ring pattern, set up the printer as described in this section.

Figure B-3 Back view of the printer

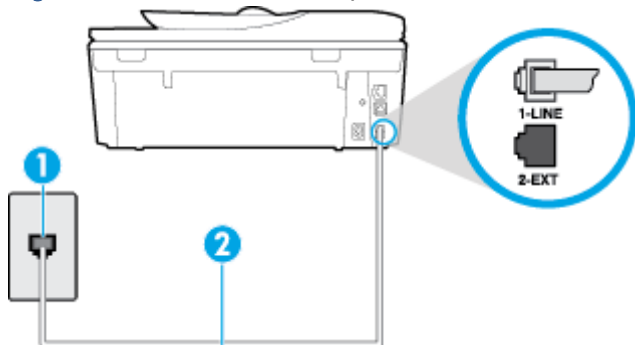

1	Telephone wall jack
2	Use the phone cord supplied in the box with the printer to connect to the 1-LINE port. You might need to connect the supplied phone cord to the adapter provided for your country/region.

### To set up the printer with a distinctive ring service

1. Using the phone cord supplied in the box with the printer, connect one end to your telephone wall jack, then connect the other end to the port labeled 1-LINE on the back of the printer.

 **NOTE:** You might need to connect the supplied phone cord to the adapter provided for your country/region.

If you do not use the supplied cord to connect from the telephone wall jack to the printer, you might not be able to fax successfully. This special phone cord is different from the phone cords you might already have in your home or office.

2. Turn on the **Auto Answer** setting.
3. Change the **Distinctive Ring** setting to match the pattern that the telephone company assigned to your fax number.

 **NOTE:** By default, the printer is set to answer all ring patterns. If you do not set the **Distinctive Ring** to match the ring pattern assigned to your fax number, the printer might answer both voice calls and fax calls or it might not answer at all.

 **TIP:** You can also use the Ring Pattern Detection feature in the printer control panel to set distinctive ring. With this feature, the printer recognizes and records the ring pattern of an incoming call and, based on this call, automatically determines the distinctive ring pattern assigned by your telephone company to fax calls. For more information, see [Change the answer ring pattern for distinctive ring on page 65](#).

4. (Optional) Change the **Rings to Answer** setting to the lowest setting (two rings).
5. Run a fax test.

The printer automatically answers incoming calls that have the ring pattern you selected (**Distinctive Ring** setting) after the number of rings you selected (**Rings to Answer** setting). The printer begins emitting fax reception tones to the sending fax machine and receives the fax.

If you encounter problems setting up the printer with optional equipment, contact your local service provider or vendor for further assistance.

## Case E: Shared voice/fax line

If you receive both voice calls and fax calls at the same phone number, and you have no other office equipment (or voice mail) on this phone line, set up the printer as described in this section.

**Figure B-4** Back view of the printer

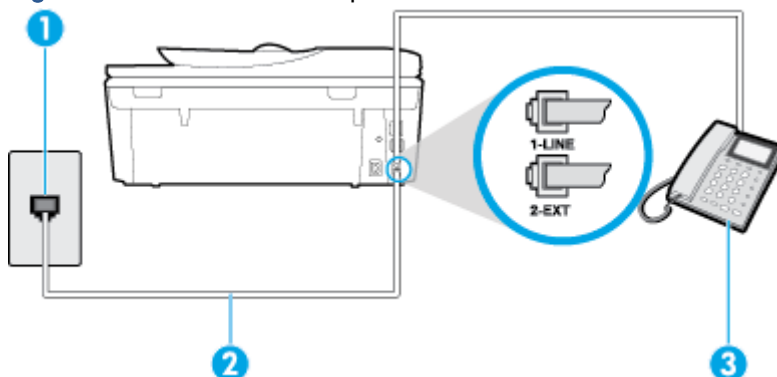

1	Telephone wall jack
2	Use the phone cord supplied in the box with the printer to connect to the 1-LINE port. You might need to connect the supplied phone cord to the adapter provided for your country/region.
3	Telephone (optional)

### To set up the printer with a shared voice/fax line

1. Using the phone cord supplied in the box with the printer, connect one end to your telephone wall jack, then connect the other end to the port labeled 1-LINE on the back of the printer.

 **NOTE:** You might need to connect the supplied phone cord to the adapter provided for your country/region.

If you do not use the supplied cord to connect from the telephone wall jack to the printer, you might not be able to fax successfully. This special phone cord is different from the phone cords you might already have in your home or office.

2. Do one of the following:
  - If you have a parallel-type phone system, remove the white plug from the port labeled 2-EXT on the back of the printer, and then connect a phone to this port.
  - If you have a serial-type phone system, you might plug your phone directly on top of the printer cable which has a wall plug attached to it.
3. Now you need to decide how you want the printer to answer calls, automatically or manually:

- If you set up the printer to answer calls **automatically**, it answers all incoming calls and receives faxes. The printer cannot distinguish between fax and voice calls in this case; if you suspect the call is a voice call, you need to answer it before the printer answers the call. To set up the printer to answer calls automatically, turn on the **Auto Answer** setting.
- If you set up the printer to answer faxes **manually**, you must be available to respond in person to incoming fax calls or the printer cannot receive faxes. To set up the printer to answer calls manually, turn off the **Auto Answer** setting.

4. Run a fax test.

If you pick up the phone before the printer answers the call and hear fax tones from a sending fax machine, you need to answer the fax call manually.

If you encounter problems setting up the printer with optional equipment, contact your local service provider or vendor for further assistance.

## Case F: Shared voice/fax line with voice mail

If you receive both voice calls and fax calls at the same phone number, and you also subscribe to a voice mail service through your telephone company, set up the printer as described in this section.

 **NOTE:** You cannot receive faxes automatically if you have a voice mail service at the same phone number you use for fax calls. You must receive faxes manually; this means you must be available to respond in person to incoming fax calls. If you want to receive faxes automatically instead, contact your telephone company to subscribe to a distinctive ring service, or to obtain a separate phone line for faxing.

Figure B-5 Back view of the printer



1 Telephone wall jack

2 Use the phone cord supplied in the box with the printer to connect to the 1-LINE port.

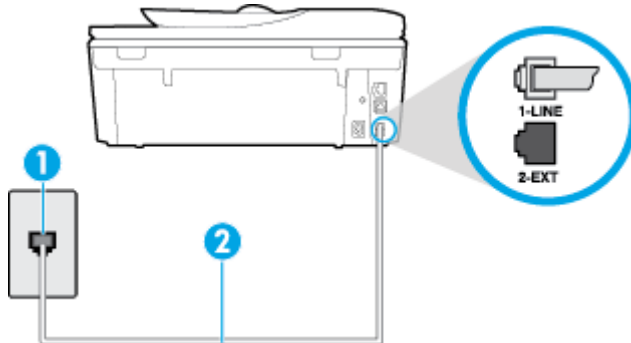
You might need to connect the supplied phone cord to the adapter provided for your country/region.

### To set up the printer with voice mail

1. Using the phone cord supplied in the box with the printer, connect one end to your telephone wall jack, then connect the other end to the port labeled 1-LINE on the back of the printer.

You might need to connect the supplied phone cord to the adapter provided for your country/region.

 **NOTE:** You might need to connect the supplied phone cord to the adapter provided for your country/region.

If you do not use the supplied cord to connect from the telephone wall jack to the printer, you might not be able to fax successfully. This special phone cord is different from the phone cords you might already have in your home or office.

2. Turn off the **Auto Answer** setting.
3. Run a fax test.

You must be available to respond in person to incoming fax calls, or the printer cannot receive faxes. You must initiate the manual fax before voicemail picks up the line.

If you encounter problems setting up the printer with optional equipment, contact your local service provider or vendor for further assistance.

## Case G: Fax line shared with computer modem (no voice calls received)

If you have a fax line on which you receive no voice calls, and you also have a computer modem connected on this line, set up the printer as described in this section.

 **NOTE:** If you have a computer dial-up modem, your computer dial-up modem shares the phone line with the printer. You cannot use both your modem and the printer simultaneously. For example, you cannot use the printer for faxing while you are using your computer dial-up modem to send an email or access the Internet.

- [Set up the printer with a computer dial-up modem](#)
- [Set up the printer with a computer DSL/ADSL modem](#)

### Set up the printer with a computer dial-up modem

If you are using the same phone line for sending faxes and for a computer dial-up modem, follow these directions for setting up the printer.

**Figure B-6** Back view of the printer

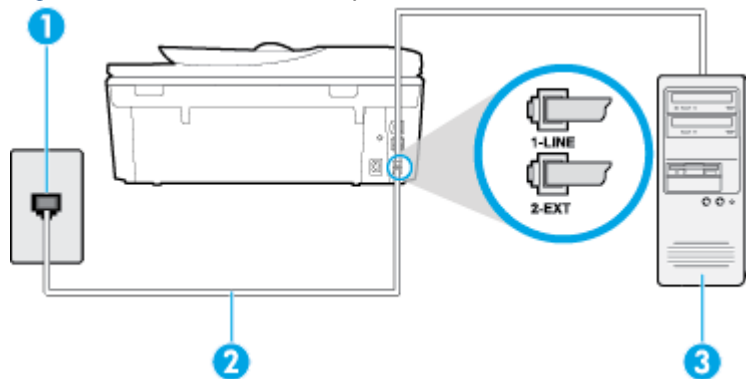

1	Telephone wall jack
2	Use the phone cord supplied in the box with the printer to connect to the 1-LINE port. You might need to connect the supplied phone cord to the adapter provided for your country/region.
3	Computer with modem

## To set up the printer with a computer dial-up modem

1. Remove the white plug from the port labeled 2-EXT on the back of the printer.
2. Find the phone cord that connects from the back of your computer (your computer dial-up modem) to a telephone wall jack. Disconnect the cord from the telephone wall jack and plug it into the port labeled 2-EXT on the back of the printer.
3. Using the phone cord supplied in the box with the printer, connect one end to your telephone wall jack, then connect the other end to the port labeled 1-LINE on the back of the printer.

 **NOTE:** You might need to connect the supplied phone cord to the adapter provided for your country/region.

If you do not use the supplied cord to connect from the telephone wall jack to the printer, you might not be able to fax successfully. This special phone cord is different from the phone cords you might already have in your home or office.

4. If your modem software is set to receive faxes to your computer automatically, turn off that setting.

 **NOTE:** If you do not turn off the automatic fax reception setting in your modem software, the printer cannot receive faxes.

5. Turn on the **Auto Answer** setting.
6. (Optional) Change the **Rings to Answer** setting to the lowest setting (two rings).
7. Run a fax test.

When the phone rings, the printer automatically answers after the number of rings you set in the **Rings to Answer** setting. The printer begins emitting fax reception tones to the sending fax machine and receives the fax.

If you encounter problems setting up the printer with optional equipment, contact your local service provider or vendor for further assistance.

## Set up the printer with a computer DSL/ADSL modem

If you have a DSL line and use that phone line to send faxes, follow these instructions to set up your fax.

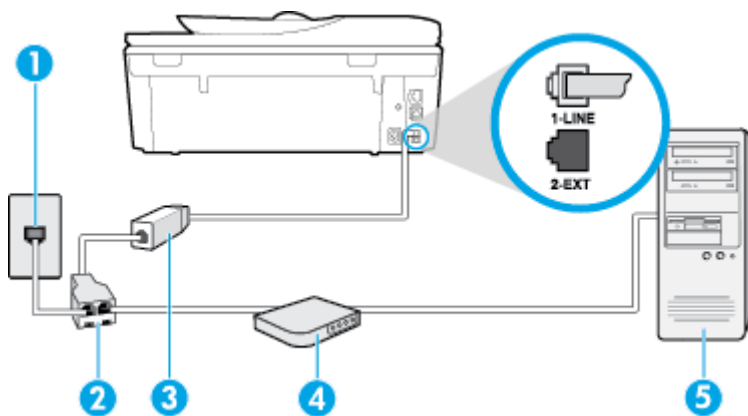

1 Telephone wall jack

2	Parallel splitter
3	DSL/ADSL filter
	Connect one end of the phone jack that was supplied with the printer to connect to the 1-LINE port on the back of the printer. Connect the other end of the cord to the DSL/ADSL filter.
	You might need to connect the supplied phone cord to the adapter provided for your country/region.
4	Computer
5	Computer DSL/ADSL modem

 **NOTE:** You need to purchase a parallel splitter. A parallel splitter has one RJ-11 port on the front and two RJ-11 ports on the back. Do not use a 2-line phone splitter, a serial splitter, or a parallel splitter which has two RJ-11 ports on the front and a plug on the back.

**Figure B-7** Example of a parallel splitter



### To set up the printer with a computer DSL/ADSL modem

1. Obtain a DSL filter from your DSL provider.
2. Using the phone cord provided in the box with the printer, connect one end to the DSL filter, and then connect the other end to the port labeled 1-LINE on the back of the printer.

 **NOTE:** You might need to connect the supplied phone cord to the adapter provided for your country/region.

If you do not use the supplied cord to connect from the DSL filter to the back of the printer, you might not be able to fax successfully. This special phone cord is different from the phone cords you might already have in your home or office.

3. Connect the DSL filter to the parallel splitter.
4. Connect the DSL modem to the parallel splitter.
5. Connect the parallel splitter to the wall jack.
6. Run a fax test.

When the phone rings, the printer automatically answers after the number of rings you set in the **Rings to Answer** setting. The printer begins emitting fax reception tones to the sending fax machine and receives the fax.

If you encounter problems setting up the printer with optional equipment, contact your local service provider or vendor for further assistance.

## Case H: Shared voice/fax line with computer modem

There are two different ways to set up the printer with your computer based on the number of phone ports on your computer. Before you begin, check your computer to see if it has one or two phone ports.

**NOTE:** If your computer has only one phone port, you need to purchase a parallel splitter (also called a coupler), as shown in the illustration. (A parallel splitter has one RJ-11 port on the front and two RJ-11 ports on the back. Do not use a two-line phone splitter, a serial splitter, or a parallel splitter which has two RJ-11 ports on the front and a plug on the back.)

- [Shared voice/fax with computer dial-up modem](#)
- [Shared voice/fax with computer DSL/ADSL modem](#)

## Shared voice/fax with computer dial-up modem

If you use your phone line for both fax and telephone calls, use these instructions to set up your fax.

There are two different ways to set up the printer with your computer based on the number of phone ports on your computer. Before you begin, check your computer to see if it has one or two phone ports.

**NOTE:** If your computer has only one phone port, you need to purchase a parallel splitter (also called a coupler), as shown in the illustration. (A parallel splitter has one RJ-11 port on the front and two RJ-11 ports on the back. Do not use a two-line phone splitter, a serial splitter, or a parallel splitter which has two RJ-11 ports on the front and a plug on the back.)

**Figure B-8** Example of a parallel splitter



**Figure B-9** Back view of the printer

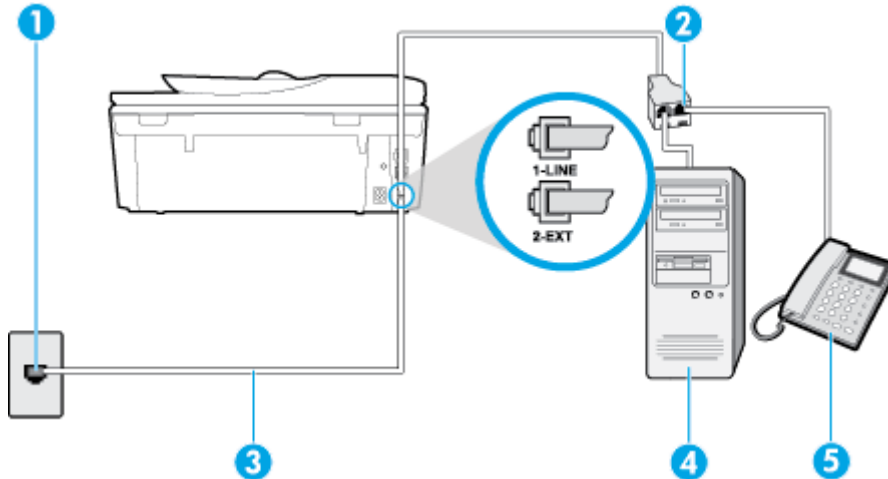

1	Telephone wall jack
2	Use the phone cord supplied in the box with the printer to connect to the 1-LINE port.
3	Parallel splitter
4	Computer with modem
5	Telephone



## To set up the printer on the same phone line as a computer with two phone ports

1. Remove the white plug from the port labeled 2-EXT on the back of the printer.
2. Find the phone cord that connects from the back of your computer (your computer dial-up modem) to a telephone wall jack. Disconnect the cord from the telephone wall jack and plug it into the port labeled 2-EXT on the back of the printer.
3. Connect a phone to the "OUT" port on the back of your computer dial-up modem.
4. Using the phone cord supplied in the box with the printer, connect one end to your telephone wall jack, then connect the other end to the port labeled 1-LINE on the back of the printer.

---

 **NOTE:** You might need to connect the supplied phone cord to the adapter provided for your country/region.

If you do not use the supplied cord to connect from the telephone wall jack to the printer, you might not be able to fax successfully. This special phone cord is different from the phone cords you might already have in your home or office.

---

5. If your modem software is set to receive faxes to your computer automatically, turn off that setting.

---

 **NOTE:** If you do not turn off the automatic fax reception setting in your modem software, the printer cannot receive faxes.

---

6. Now you need to decide how you want the printer to answer calls, automatically or manually:
  - If you set up the printer to answer calls **automatically**, it answers all incoming calls and receives faxes. The printer cannot distinguish between fax and voice calls in this case; if you suspect the call is a voice call, you need to answer it before the printer answers the call. To set up the printer to answer calls automatically, turn on the **Auto Answer** setting.
  - If you set up the printer to answer faxes **manually**, you must be available to respond in person to incoming fax calls or the printer cannot receive faxes. To set up the printer to answer calls manually, turn off the **Auto Answer** setting.

7. Run a fax test.

If you pick up the phone before the printer answers the call and hear fax tones from a sending fax machine, you need to answer the fax call manually.

If you use your phone line for voice, fax, and your computer dial-up modem, follow these directions to set up your fax.

If you encounter problems setting up the printer with optional equipment, contact your local service provider or vendor for further assistance.

## Shared voice/fax with computer DSL/ADSL modem

Use these instructions if your computer has a DSL/ADSL modem

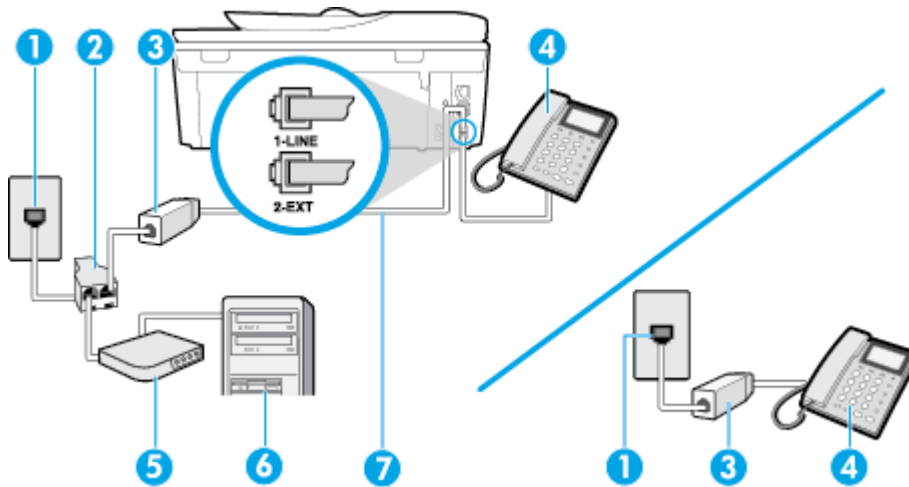

1	Telephone wall jack
2	Parallel splitter
3	DSL/ADSL filter
4	Use the phone cord provided to connect to the 1-LINE port on the back of the printer. You might need to connect the supplied phone cord to the adapter provided for your country/region.
5	DSL/ADSL modem
6	Computer
7	Telephone

**NOTE:** You need to purchase a parallel splitter. A parallel splitter has one RJ-11 port on the front and two RJ-11 ports on the back. Do not use a 2-line phone splitter, a serial splitter, or a parallel splitter which has two RJ-11 ports on the front and a plug on the back.

**Figure B-10** Example of a parallel splitter



### To set up the printer with a computer DSL/ADSL modem

1. Obtain a DSL filter from your DSL provider.

**NOTE:** Phones in other parts of the home/office sharing the same phone number with DSL service need to be connected to additional DSL filters to avoid noise when making voice calls.

2. Using the phone cord supplied in the box with the printers, connect one end to the DSL filter, then connect the other end to the port labeled 1-LINE on the back of the printer.

**NOTE:** You might need to connect the supplied phone cord to the adapter provided for your country/region.

If you do not use the supplied cord to connect from the DSL filter to the printer, you might not be able to fax successfully. This special phone cord is different from phone cords you might already have in your home or office.

3. If you have a parallel-type phone system, remove the white plug from the port labeled 2-EXT on the back of the printer, and then connect a phone to this port.
4. Connect the DSL filter to the parallel splitter.
5. Connect the DSL modem to the parallel splitter.
6. Connect the parallel splitter to the wall jack.
7. Run a fax test.

When the phone rings, the printer automatically answers after the number of rings you set in the **Rings to Answer** setting. The printer begins emitting fax reception tones to the sending fax machine and receives the fax.

If you encounter problems setting up the printer with optional equipment, contact your local service provider or vendor for further assistance.

## Case I: Shared voice/fax line with answering machine

If you receive both voice calls and fax calls at the same phone number, and you also have an answering machine that answers voice calls at this phone number, set up the printer as described in this section.

**Figure B-11** Back view of the printer

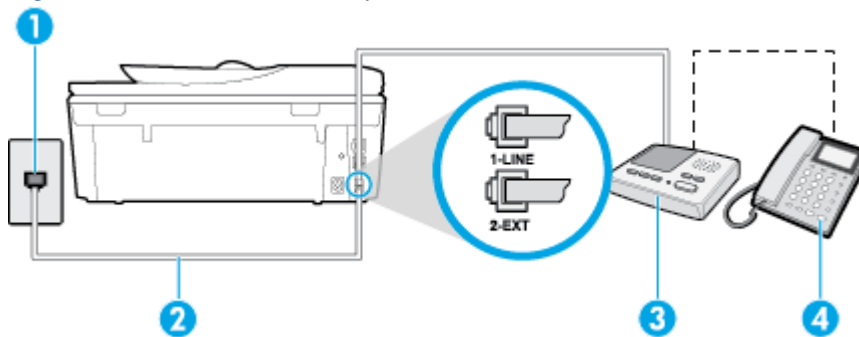

1	Telephone wall jack
2	Use the phone cord provided to connect to the 1-LINE port on the back of the printer  You might need to connect the supplied phone cord to the adapter provided for your country/region.
3	Answering machine
4	Telephone (optional)

### To set up the printer with a shared voice/fax line with answering machine

1. Remove the white plug from the port labeled 2-EXT on the back of the printer.
2. Unplug your answering machine from the telephone wall jack, and connect it to the port labeled 2-EXT on the back of the printer.

**NOTE:** If you do not connect your answering machine directly to the printer, fax tones from a sending fax machine might be recorded on your answering machine, and you might not receive faxes with the printer.

- Using the phone cord supplied in the box with the printer, connect one end to your telephone wall jack, then connect the other end to the port labeled 1-LINE on the back of the printer.

---

 **NOTE:** You might need to connect the supplied phone cord to the adapter provided for your country/region.

If you do not use the supplied cord to connect from the telephone wall jack to the printer, you might not be able to fax successfully. This special phone cord is different from the phone cords you might already have in your home or office.

---

- (Optional) If your answering machine does not have a built-in phone, for convenience you might want to connect a phone to the back of your answering machine at the "OUT" port.

---

 **NOTE:** If your answering machine does not let you connect an external phone, you can purchase and use a parallel splitter (also known as a coupler) to connect both the answering machine and telephone to the printer. You can use standard phone cords for these connections.

---

- Turn on the **Auto Answer** setting.
- Set your answering machine to answer after a low number of rings.
- Change the **Rings to Answer** setting on the printer to the maximum number of rings supported by your printer. (The maximum number of rings varies by country/region.)
- Run a fax test.

When the phone rings, your answering machine answers after the number of rings you have set, and then plays your recorded greeting. The printer monitors the call during this time, "listening" for fax tones. If incoming fax tones are detected, the printer emits fax reception tones and receives the fax; if there are no fax tones, the printer stops monitoring the line and your answering machine can record a voice message.

If you encounter problems setting up the printer with optional equipment, contact your local service provider or vendor for further assistance.

## Case J: Shared voice/fax line with computer modem and answering machine

If you receive both voice calls and fax calls at the same phone number, and you also have a computer modem and answering machine connected on this phone line, set up the printer as described in this section.

---

 **NOTE:** Since your computer dial-up modem shares the phone line with the printer, you cannot use both your modem and the printer simultaneously. For example, you cannot use the printer for faxing while you are using your computer dial-up modem to send an email or access the Internet.

---

- [Shared voice/fax line with computer dial-up modem and answering machine](#)
- [Shared voice/fax line with computer DSL/ADSL modem and answering machine](#)

## Shared voice/fax line with computer dial-up modem and answering machine

There are two different ways to set up the printer with your computer based on the number of phone ports on your computer. Before you begin, check your computer to see if it has one or two phone ports.

**NOTE:** If your computer has only one phone port, you need to purchase a parallel splitter (also called a coupler), as shown in the illustration. (A parallel splitter has one RJ-11 port on the front and two RJ-11 ports on the back. Do not use a two-line phone splitter, a serial splitter, or a parallel splitter which has two RJ-11 ports on the front and a plug on the back.)

**Figure B-12** Example of a parallel splitter



**Figure B-13** Back view of the printer

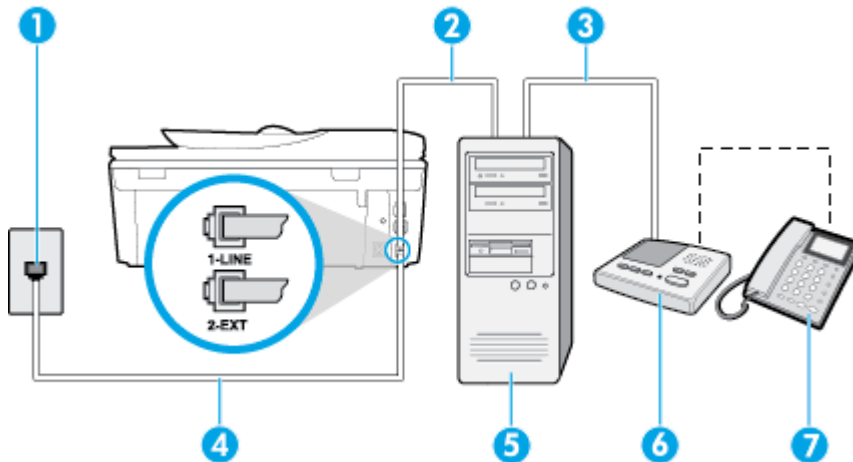

1	Telephone wall jack
2	"IN" phone port on your computer
3	"OUT" phone port on your computer
4	Telephone (optional)
5	Answering machine
6	Computer with modem
7	Use the phone cord supplied in the box with the printer to connect to the 1-LINE port. You might need to connect the supplied phone cord to the adapter provided for your country/region.

### To set up the printer on the same phone line as a computer with two phone ports

1. Remove the white plug from the port labeled 2-EXT on the back of the printer.
2. Find the phone cord that connects from the back of your computer (your computer dial-up modem) to a telephone wall jack. Disconnect the cord from the telephone wall jack and plug it into the port labeled 2-EXT on the back of the printer.
3. Unplug your answering machine from the telephone wall jack, and connect it to the port labeled "OUT" on the back of the computer (the computer dial-up modem).

- Using the phone cord supplied in the box with the printer, connect one end to your telephone wall jack, then connect the other end to the port labeled 1-LINE on the back of the printer.



---

**NOTE:** You might need to connect the supplied phone cord to the adapter provided for your country/region.

If you do not use the supplied cord to connect from the telephone wall jack to the printer, you might not be able to fax successfully. This special phone cord is different from the phone cords you might already have in your home or office.

---

- (Optional) If your answering machine does not have a built-in phone, for convenience you might want to connect a phone to the back of your answering machine at the "OUT" port.



---

**NOTE:** If your answering machine does not let you connect an external phone, you can purchase and use a parallel splitter (also known as a coupler) to connect both the answering machine and telephone to the printer. You can use standard phone cords for these connections.

---

- If your modem software is set to receive faxes to your computer automatically, turn off that setting.



---

**NOTE:** If you do not turn off the automatic fax reception setting in your modem software, the printer cannot receive faxes.

---

- Turn on the **Auto Answer** setting.
- Set your answering machine to answer after a low number of rings.
- Change the **Rings to Answer** setting on the printer to the maximum number of rings supported by the product. (The maximum number of rings varies by country/region.)
- Run a fax test.

When the phone rings, your answering machine answers after the number of rings you have set, and then plays your recorded greeting. The printer monitors the call during this time, "listening" for fax tones. If incoming fax tones are detected, the printer emits fax reception tones and receives the fax; if there are no fax tones, the printer stops monitoring the line and your answering machine can record a voice message.

If you encounter problems setting up the printer with optional equipment, contact your local service provider or vendor for further assistance.

## Shared voice/fax line with computer DSL/ADSL modem and answering machine

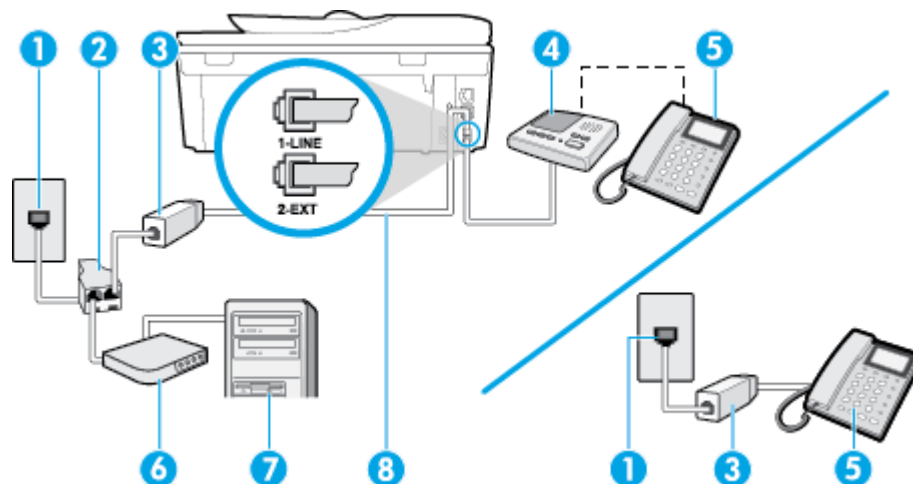

1	Telephone wall jack
2	Parallel splitter
3	DSL/ADSL filter
4	Phone cord provided with the printer connected to the 1-LINE port on the back of the printer You might need to connect the supplied phone cord to the adapter provided for your country/region.
5	DSL/ADSL modem
6	Computer
7	Answering machine
8	Telephone (optional)

 **NOTE:** You need to purchase a parallel splitter. A parallel splitter has one RJ-11 port on the front and two RJ-11 ports on the back. Do not use a 2-line phone splitter, a serial splitter, or a parallel splitter which has two RJ-11 ports on the front and a plug on the back.

**Figure B-14** Example of a parallel splitter



## To set up the printer with a computer DSL/ADSL modem

1. Obtain a DSL/ADSL filter from your DSL/ADSL provider.

---

 **NOTE:** Phones in other parts of the home/office sharing the same phone number with DSL/ADSL service need to be connected to additional DSL/ADSL filters, to avoid noise when making voice calls.

---

2. Using the phone cord supplied in the box with the printer, connect one end to the DSL/ADSL filter, then connect the other end to the port labeled 1-LINE on the back of the printer.

---

 **NOTE:** You might need to connect the supplied phone cord to the adapter provided for your country/region.

---

If you do not use the supplied cord to connect from the DSL/ADSL filter to the printer, you might not be able to fax successfully. This special phone cord is different from the phone cords you might already have in your home or office.

---

3. Connect the DSL/ADSL filter to the splitter.
4. Unplug the answering machine from the telephone wall jack, and connect it to the port labeled 2-EXT on the back of the printer.

---

 **NOTE:** If you do not connect your answering machine directly to the printer, fax tones from a sending fax machine might be recorded on your answering machine, and you might not receive faxes with the printer.

---

5. Connect the DSL modem to the parallel splitter.
6. Connect the parallel splitter to the wall jack.
7. Set your answering machine to answer after a low number of rings.
8. Change your **Rings to Answer** setting on the printer to the maximum number of rings supported by the printer.

---

 **NOTE:** The maximum number of rings varies by country/region.

---

9. Run a fax test.

When the phone rings, your answering machine answers after the number of rings you have set, and then play your recorded greeting. The printer monitors the call during this time, “listening” for fax tones. If incoming fax tones are detected, the printer emits fax reception tones and receive the fax; if there are no fax tones, the printer stops monitoring the line and your answering machine can record a voice message.

If you use the same phone line for telephone, fax, and have a computer DSL modem, follow these instructions to set up your fax.

If you encounter problems setting up the printer with optional equipment, contact your local service provider or vendor for further assistance.

## Case K: Shared voice/fax line with computer dial-up modem and voice mail

If you receive both voice calls and fax calls at the same phone number, use a computer dial-up modem on the same phone line, and subscribe to a voice mail service through your telephone company, set up the printer as described in this section.



**NOTE:** You cannot receive faxes automatically if you have a voice mail service at the same phone number you use for fax calls. You must receive faxes manually; this means you must be available to respond in person to incoming fax calls. If you want to receive faxes automatically instead, contact your telephone company to subscribe to a distinctive ring service, or to obtain a separate phone line for faxing.

Since your computer dial-up modem shares the phone line with the printer, you cannot use both your modem and the printer simultaneously. For example, you cannot use the printer for faxing if you are using your computer dial-up modem to send an email or access the Internet.

There are two different ways to set up the printer with your computer based on the number of phone ports on your computer. Before you begin, check your computer to see if it has one or two phone ports.

- If your computer has only one phone port, you need to purchase a parallel splitter (also called a coupler), as shown in the illustration. (A parallel splitter has one RJ-11 port on the front and two RJ-11 ports on the back. Do not use a two-line phone splitter, a serial splitter, or a parallel splitter which has two RJ-11 ports on the front and a plug on the back.)

**Figure B-15** Example of a parallel splitter



- If your computer has two phone ports, set up the printer as follows:

**Figure B-16** Back view of the printer

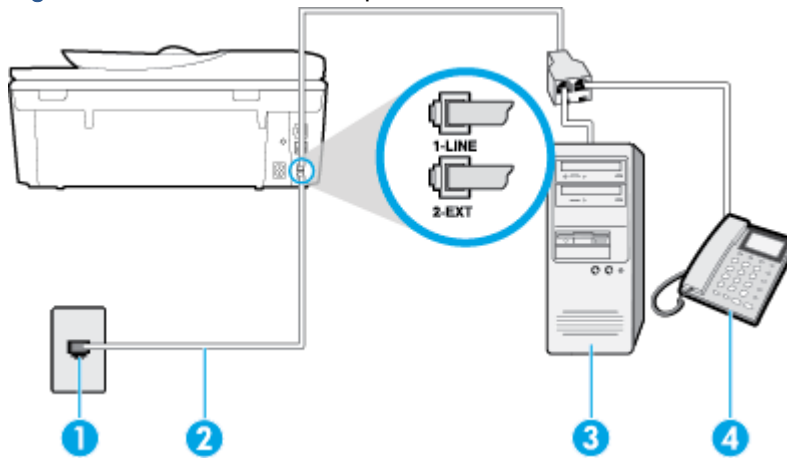

1	Telephone wall jack
2	Use the phone cord supplied in the box with the printer to connect to the 1-LINE port You might need to connect the supplied phone cord to the adapter provided for your country/region.
3	Computer with modem
4	Telephone

## To set up the printer on the same phone line as a computer with two phone ports

1. Remove the white plug from the port labeled 2-EXT on the back of the printer.
2. Find the phone cord that connects from the back of your computer (your computer dial-up modem) to a telephone wall jack. Disconnect the cord from the telephone wall jack and plug it into the port labeled 2-EXT on the back of the printer.
3. Connect a phone to the "OUT" port on the back of your computer dial-up modem.
4. Using the phone cord supplied in the box with the printer, connect one end to your telephone wall jack, then connect the other end to the port labeled 1-LINE on the back of the printer.

---

 **NOTE:** You might need to connect the supplied phone cord to the adapter provided for your country/region.

If you do not use the supplied cord to connect from the telephone wall jack to the printer, you might not be able to fax successfully. This special phone cord is different from the phone cords you might already have in your home or office.

---

5. If your modem software is set to receive faxes to your computer automatically, turn off that setting.

---

 **NOTE:** If you do not turn off the automatic fax reception setting in your modem software, the printer cannot receive faxes.

---

6. Turn off the **Auto Answer** setting.
7. Run a fax test.

You must be available to respond in person to incoming fax calls, or the printer cannot receive faxes.

If you encounter problems setting up the printer with optional equipment, contact your local service provider or vendor for further assistance.

## Serial-type fax setup

For information on setting up the printer for faxing using a serial-type phone system, see the Fax Configuration website for your country/region.

Austria	<a href="http://www.hp.com/at/faxconfig">www.hp.com/at/faxconfig</a>
Germany	<a href="http://www.hp.com/de/faxconfig">www.hp.com/de/faxconfig</a>
Switzerland (French)	<a href="http://www.hp.com/ch/fr/faxconfig">www.hp.com/ch/fr/faxconfig</a>
Switzerland (German)	<a href="http://www.hp.com/ch/de/faxconfig">www.hp.com/ch/de/faxconfig</a>
United Kingdom	<a href="http://www.hp.com/uk/faxconfig">www.hp.com/uk/faxconfig</a>
Finland	<a href="http://www.hp.fi/faxconfig">www.hp.fi/faxconfig</a>
Denmark	<a href="http://www.hp.dk/faxconfig">www.hp.dk/faxconfig</a>
Sweden	<a href="http://www.hp.se/faxconfig">www.hp.se/faxconfig</a>
Norway	<a href="http://www.hp.no/faxconfig">www.hp.no/faxconfig</a>
Netherlands	<a href="http://www.hp.nl/faxconfig">www.hp.nl/faxconfig</a>
Belgium (Dutch)	<a href="http://www.hp.be/nl/faxconfig">www.hp.be/nl/faxconfig</a>
Belgium (French)	<a href="http://www.hp.be/fr/faxconfig">www.hp.be/fr/faxconfig</a>
Portugal	<a href="http://www.hp.pt/faxconfig">www.hp.pt/faxconfig</a>
Spain	<a href="http://www.hp.es/faxconfig">www.hp.es/faxconfig</a>
France	<a href="http://www.hp.com/fr/faxconfig">www.hp.com/fr/faxconfig</a>
Ireland	<a href="http://www.hp.com/ie/faxconfig">www.hp.com/ie/faxconfig</a>
Italy	<a href="http://www.hp.com/it/faxconfig">www.hp.com/it/faxconfig</a>

## Test fax setup

You can test your fax setup to check the status of the printer and to make sure it is set up correctly for faxing. Perform this test after you have completed setting up the printer for faxing. The test does the following:

- Tests the fax hardware
- Verifies the correct type of phone cord is connected to the printer
- Checks that the phone cord is plugged into the correct port
- Checks for a dial tone
- Checks for an active phone line
- Tests the status of your phone line connection

The printer prints a report with the results of the test. If the test fails, review the report for information on how to fix the problem and rerun the test.

### To test fax setup via the printer control panel

1. Set up the printer for faxing according to your particular home or office setup instructions.
2. Make sure the ink cartridges are installed, and that full-size paper is loaded in the input tray before starting the test.
3. From the printer control panel, touch **Setup**.
4. Touch **Fax Setup**.
5. Touch **Tools**, and then touch **Run Fax Test**.

The printer displays the status of the test on the display and prints a report.

6. Review the report.
  - If the test passes and you are still having problems faxing, check the fax settings listed in the report to verify the settings are correct. A blank or incorrect fax setting can cause problems faxing.
  - If the test fails, review the report for more information on how to fix any problems found.

---

## C Errors (Windows)

- [Low on ink](#)
- [Very low on ink](#)
- [Ink cartridge problem](#)
- [Paper size mismatch](#)
- [Ink cartridge carriage stalled](#)
- [Paper jam or tray problem](#)
- [Out of paper](#)
- [Document failed to print](#)
- [Printer failure](#)
- [Door open](#)
- [Ink cartridge failure](#)
- [Counterfeit Cartridge Advisory](#)
- [Incompatible ink cartridges](#)
- [Paper too short](#)
- [Paper too long to auto-duplex](#)
- [Incompatible HP Instant Ink Cartridge](#)
- [Used HP Instant Ink Cartridge](#)
- [Please Connect Printer to HP Connected](#)
- [Cannot Print](#)
- [HP Protected Cartridge Installed](#)

## Low on ink

The ink cartridge identified in the message is low on ink.

Ink level warnings and indicators provide estimates for planning purposes only. When you receive a low ink warning message, consider having a replacement cartridge available to avoid possible printing delays. You do not need to replace cartridges until the print quality becomes unacceptable.

For information about replacing ink cartridges, see [Replace the cartridges on page 76](#). For information about ordering ink cartridges, see [Order ink supplies on page 78](#).



**NOTE:** Ink from the cartridges is used in the printing process in a number of different ways, including in the initialization process, which prepares the printer and cartridges for printing. In addition, some residual ink is left in the cartridge after it is used. For more information see [www.hp.com/go/inkusage](http://www.hp.com/go/inkusage).

---

## Very low on ink

The ink cartridge identified in the message is very low on ink.

Ink level warnings and indicators provide estimates for planning purposes only. When you receive a very low ink warning message, HP recommends having a replacement cartridge available to avoid possible printing delays. You do not need to replace cartridges until the print quality is unacceptable.

For information about replacing ink cartridges, see [Replace the cartridges on page 76](#). For information about ordering ink cartridges, see [Order ink supplies on page 78](#).



**NOTE:** Ink from the cartridges is used in the printing process in a number of different ways, including in the initialization process, which prepares the printer and cartridges for printing. In addition, some residual ink is left in the cartridge after it is used. For more information see [www.hp.com/go/inkusage](http://www.hp.com/go/inkusage).

---

## Ink cartridge problem

The ink cartridge identified in the message is missing, damaged, incompatible, or inserted into the wrong slot in the printer.



---

**NOTE:** If the cartridge is identified in the message as incompatible, see [Order ink supplies on page 78](#) for information about obtaining cartridges for the printer.

---

To solve this problem, try the following solutions. Solutions are listed in order, with the most likely solution first. If the first solution does not solve the problem, continue trying the remaining solutions until the issue is resolved.

- Solution 1: Turn the printer off and on.
- Solution 2: Install the ink cartridges correctly.

### **Solution 1: Turn the printer off and on**

Turn off the printer, and then turn it on again.

If the problem persists, try the next solution.

### **Solution 2: Install the ink cartridges correctly**

Make sure all of the ink cartridges are properly installed:

1. Gently pull open the ink cartridge access door.
2. Remove the ink cartridge by pushing it in to release it, and then pulling it firmly toward you.
3. Insert the cartridge into the slot. Press firmly on the cartridge to ensure proper contact.
4. Close the ink cartridge access door and check if the error message has gone away.



## Paper size mismatch

The paper size or type selected in the printer driver does not match the paper loaded in the printer. Make sure that the correct paper is loaded in the printer, and then print the document again. For more information, see [Load media on page 12](#).



---

**NOTE:** If the paper loaded in the printer is the correct size, change the selected paper size in the printer driver, and then print the document again.

---

## Ink cartridge carriage stalled

Something is blocking the ink cartridge carriage (the part of the printer that holds the ink cartridges).

To clear the obstruction check the printer for jams.

For more information, see [Jams and paper-feed issues on page 96](#).

## Paper jam or tray problem

Paper has become jammed in the printer.

Before you try to clear the jam, check the following:

- Make sure that you have loaded paper that meets specifications and is not wrinkled, folded, or damaged. For more information, see [Paper basics on page 9](#).
- Make sure that the printer is clean.
- Make sure that the trays are loaded correctly and are not too full. For more information, see [Load media on page 12](#).

For instructions on clearing jams, as well as more information about how to avoid jams, see [Jams and paper-feed issues on page 96](#).

## Out of paper

The default tray is empty.

Load more paper, and then touch **OK**.

For more information, see [Load media on page 12](#).



## Document failed to print

The printer could not print the document because a problem occurred in the printing system.

For information about solving printing problems, see [Printer hardware issues on page 126](#).

## Printer failure

There was a problem with the printer or ink system. Usually, you can resolve such problems by completing the following steps:

1. Press  (the Power button) to turn off the printer.
2. Unplug the power cord, and then plug in the power cord again.
3. Press  (the Power button) to turn on the printer.

If this problem persists, write down the error code provided in the message, and then contact HP support. For more information about contacting HP support, see [HP support on page 128](#).

## Door open

Before the printer can print documents, all doors and covers must be closed.

---

 **TIP:** When completely closed, most doors and covers snap into place.

---

If the problem persists after you've securely closed all doors and covers, contact HP support. For more information, see [HP support on page 128](#).

## Ink cartridge failure

The cartridges listed in the message are damaged or have failed.

See [Replace the cartridges on page 76](#).



## Counterfeit Cartridge Advisory

The installed cartridge is not a new, genuine HP cartridge. Contact the store where this cartridge was purchased. To report suspected fraud, visit HP at [www.hp.com/go/anticounterfeit](http://www.hp.com/go/anticounterfeit). To continue using the cartridge, click **Continue**.

## Incompatible ink cartridges

The ink cartridge is not compatible with your printer.

Solution: Remove this cartridge immediately and replace with a compatible ink cartridge. For information about how to install new cartridges, see [Replace the cartridges on page 76](#).

## Paper too short

The paper loaded is shorter than the minimum requirement. Paper that meets the printer requirements must be loaded. For more information, see [Paper basics on page 9](#) and [Load media on page 12](#).

## Paper too long to auto-duplex

The paper loaded is longer than supported by the printer automatic duplexing. You can manually duplex it by selecting "manual duplex" or "print odd pages" and "print even pages" in your printer software (if supported). For more information, see [Paper basics on page 9](#) and [Load media on page 12](#).

## Incompatible HP Instant Ink Cartridge

This cartridge can only be used in a printer that is currently enrolled in HP Instant Ink.

If you believe your printer should accept this cartridge, please contact [www.hp.com/buy/supplies](http://www.hp.com/buy/supplies).

## Used HP Instant Ink Cartridge

The HP Instant Ink cartridge(s) listed on the printer control panel display can only be used in the HP Instant Ink printer that initially installed the cartridge. The cartridge must be replaced.

For information about replacing ink cartridges, see [Replace the cartridges on page 76](#). For information about ordering ink cartridges, see [Order ink supplies on page 78](#).

## Please Connect Printer to HP Connected

The printer must be connected to HP Connected, otherwise you will be unable to print soon without further warning. See the printer control panel for instructions on connecting.

## Cannot Print

The printer needs to be connected to HP Connected to update its Instant Ink status.

You will be unable to print until the printer has been connected to update the Instant Ink status. See the printer control panel for instructions on connecting.



## HP Protected Cartridge Installed

The ink cartridge listed on the printer control panel can only be used in the printer that initially protected the cartridge using the HP Cartridge Protection feature. The ink cartridge must be replaced in this printer.

For information about how to install a new ink cartridge, see [Replace the cartridges on page 76](#).

---

# Index

- A**
  - accessibility 20
  - ADSL, fax setup with
    - parallel phone systems 146
  - after the support period 129
  - answer ring pattern
    - change 65
    - parallel phone systems 148
  - answering machine
    - fax tones recorded 123
    - set up with fax (parallel phone systems) 157
    - set up with fax and modem 158
  - automatic fax reduction 57
- B**
  - backup fax 56
  - baud rate 67
  - black and white pages
    - fax 49
  - blocked fax numbers
    - set up 58
  - both sides, print on 25
  - broadcast faxing
    - send 53
  - buttons, control panel 5
- C**
  - carriage
    - clear carriage jams 99
  - clear
    - fax logs 72
  - computer modem
    - shared with fax (parallel phone systems) 151
    - shared with fax and answering machine (parallel phone systems) 158
  - shared with fax and voice line (parallel phone systems) 153
  - shared with fax and voice mail (parallel phone systems) 162
  - confirmation reports, fax 70
  - connectors, locating 4
  - control panel
    - buttons 5
    - features 5
    - lights 5
    - status icons 6
  - copy
    - specifications 133
  - correct port test, fax 116
  - customer support
    - warranty 129
- D**
  - dial tone test, failure 117
  - dial type, setting 66
  - dial-up modem
    - shared with fax (parallel phone systems) 151
    - shared with fax and answering machine (parallel phone systems) 158
    - shared with fax and voice line (parallel phone systems) 153
    - shared with fax and voice mail (parallel phone systems) 162
  - distinctive ringing
    - change 65
    - parallel phone systems 148
  - double-sided printing 25
- DSL, fax setup with
  - parallel phone systems 146
- E**
  - ECM. *See* error correction mode
  - embedded web server
    - Webscan 36
  - environment
    - Environmental product
      - stewardship program 134
    - environmental specifications 132
  - error correction mode 53
  - error reports, fax 71
- F**
  - fax
    - answer mode 64
    - answering machine and modem, shared with (parallel phone systems) 158
    - answering machine
      - troubleshoot 123
    - answering machine, set up (parallel phone systems) 157
    - auto answer 64
    - backup fax 56
    - blocking numbers 58
    - confirmation reports 70
    - dial tone test, failed 117
    - dial type, setting 66
    - distinctive ringing setup (parallel phone systems) 148
    - distinctive ringing, change pattern 65
    - DSL, set up (parallel phone systems) 146

- error correction mode 53
- error reports 71
- forwarding 57
- header 64
- Internet Protocol, over 69
- ISDN line, set up (parallel phone systems) 147
- line condition test, failed 118
- log, clear 72
- log, print 71
- manual receive 55
- modem and answering machine, shared with (parallel phone systems) 158
- modem and voice line, shared with (parallel phone systems) 153
- modem and voice mail, shared with (parallel phone systems) 162
- modem, shared with (parallel phone systems) 151
- monitor dialing 52, 53
- parallel phone systems 142
- PBX system, set up (parallel phone systems) 147
- phone cord connection test, failed 116
- phone cord type test, failed 117
- print last transaction details 72
- receive 55
- receive, troubleshoot 119, 121
- redial options 66
- reduction 57
- reports 70
- reprint 56
- rings to answer 65
- send 50
- send, troubleshoot 119, 122
- separate line setup (parallel phone systems) 145
- settings, change 64
- setup types 143
- shared phone line setup (parallel phone systems) 149
- sound volume 67

- speed 67
- test failed 114
- test setup 166
- troubleshoot 114
- voice mail, set up (parallel phone systems) 150
- wall jack test, failed 115
- Fax screen 6
- FoIP 69
- forwarding faxes 57

**G**

- glass, scanner locating 3

**H**

- hardware, fax setup test 115
- header, fax 64
- Help button 6
- HP Utility (OS X) opening 92

**I**

- ink cartridges 4
- Internet Protocol fax, using 69
- IP settings 90
- ISDN line, set up with fax parallel phone systems 147

**J**

- jams clear 96
  - paper to avoid 11
- junk fax mode 58

**L**

- lights, control panel 5
- line condition test, fax 118
- link speed, setting 90
- log, fax print 71

**M**

- manual faxing
  - receive 55
  - send 51, 52
- media duplexing 25

- memory
  - reprint faxes 56
  - save faxes 56
- modem
  - shared with fax (parallel phone systems) 151
  - shared with fax and answering machine (parallel phone systems) 158
  - shared with fax and voice line (parallel phone systems) 153
  - shared with fax and voice mail (parallel phone systems) 162
- monitor dialing 52, 53
- multi-feeds, troubleshoot 101

**N**

- networks
  - connector illustration 4
  - IP settings 90
  - link speed 90
  - settings, change 90
  - wireless communication setup 84

**O**

- OS X
  - HP Utility 92
- output tray
  - locating 3

**P**

- paper
  - clear jams 96
  - HP, order 11
  - selecting 11
  - skewed pages 100
  - troubleshoot feeding 100
- paper-feed problems, troubleshoot 100
- parallel phone systems
  - answering machine setup 157
  - countries/regions with 142
  - distinctive ringing setup 148
  - DSL setup 146
  - ISDN setup 147
  - modem and answering machine setup 158

- modem and voice mail setup 162
- modem setup 151
- modem shared with voice line setup 153
- PBX setup 147
- separate line setup 145
- setup types 143
- shared line setup 149
- PBX system, set up with fax parallel phone systems 147
- phone book
  - change contact 61
  - change group contacts 62
  - delete contacts 63
  - print list 63
  - send fax 50
  - set up 61
  - set up group contacts 62
- phone cord
  - connected to correct port test failed 116
  - correct type test failed 117
- phone line, answer ring pattern 65
- phone support 128
- phone support period
  - period for support 129
- phone, fax from
  - receive 55
  - send, 51
- power
  - troubleshoot 126
- power input, locating 4
- print
  - double-sided 25
  - fax logs 71
  - fax reports 70
  - faxes 56
  - last fax details 72
  - specifications 132
  - troubleshoot 126
- printer control panel
  - locating 3
  - network settings 90
  - send faxes 50
- printer software (Windows)
  - about 92
  - opening 18, 92
- pulse dialing 66

**R**

- radio interference
  - regulatory information 139
- rear access panel
  - illustration 4
- receive faxes
  - auto answer mode 64
  - automatically 55
  - blocking numbers 58
  - forwarding 57
  - manually 55
  - rings to answer 65
  - troubleshoot 119, 121
- recycle
  - ink cartridges 135
- redial options, setting 66
- reduce fax 57
- regulatory information 137, 139
- regulatory notices
  - regulatory model identification number 137
- reports
  - confirmation, fax 70
  - error, fax 71
  - fax test failed 114
- reprint
  - faxes from memory 56
- rings to answer 65

**S**

- save
  - faxes in memory 56
- scan
  - from Webscan 36
  - scan specifications 132
- scanner glass
  - locating 3
- send faxes
  - basic fax 50
  - from a phone 51
  - memory, from 52
  - monitor dialing 52, 53
  - troubleshoot 119, 122
- serial phone systems
  - countries/regions with 142
  - setup types 143
- settings
  - network 90
  - speed, fax 67
  - volume, fax 67

setup

- answering machine (parallel phone systems) 157
- answering machine and modem (parallel phone systems) 158
- computer modem (parallel phone systems) 151
- computer modem and answering machine (parallel phone systems) 158
- computer modem and voice line (parallel phone systems) 153
- computer modem and voice mail (parallel phone systems) 162
- distinctive ringing 65
- distinctive ringing (parallel phone systems) 148
- DSL (parallel phone systems) 146
- fax scenarios 143
- fax, with parallel phone systems 142
- ISDN line (parallel phone systems) 147
- PBX system (parallel phone systems) 147
- separate fax line (parallel phone systems) 145
- shared phone line (parallel phone systems) 149
- test fax 166
- voice mail (parallel phone systems) 150
- voice mail and computer modem (parallel phone systems) 162

skew, troubleshoot  
print 100

software  
Webscan 36

status icons 6

subscriber identification code 64

support process 128

system requirements 132

## T

### technical information

- copy specifications 133
- environmental specifications 132
- print specifications 132
- scan specifications 132
- system requirements 132

### telephone line, answer ring

pattern 65

### telephone wall jack, fax 115

### telephone, fax from

- receive 55
- send 51

### tests, fax

- dial tone, failed 117
- failed 114
- fax line condition 118
- fax phone cord type test failed 117
- hardware, failed 115
- port connection, failed 116
- setup 166
- telephone wall jack 115

### tone dialing 66

### trays

- clear paper jams 96
- locating 3
- paper-width guides illustration 3
- troubleshoot feeding 100

### troubleshoot

- answering machines 123
- fax 114
- fax dial tone test failed 117
- fax hardware test failed 115
- fax line test failed 118
- fax phone cord connection test failed 116
- fax phone cord type test failed 117
- fax tests 114
- fax wall jack test, failed 115
- multiple pages are picked 101
- paper not picked up from tray 100
- paper-feed problems 100
- power 126
- print 126
- receive faxes 119, 121

send faxes 119, 122

skewed pages 100

two-sided printing 25

## U

### USB connection

port, locating 3, 4

## V

### voice mail

- set up with fax (parallel phone systems) 150
- set up with fax and computer modem (parallel phone systems) 162

### volume

fax sounds 67

## W

wall jack test, fax 115

warranty 129

Webscan 36

### websites

accessibility information 20

### wireless communication

- regulatory information 139
- set up 84