

PIXMA iX5000 / iX4000

SERVICE MANUAL

Revision 0

QY8-13AP-000

COPYRIGHT©2006 CANON INC. CANON PIXMA iX5000 / iX4000 0206 XX 0.00-0

Scope

This manual has been issued by Canon Inc., to provide the service technicians of this product with the information necessary for qualified persons to learn technical theory, installation, maintenance, and repair of products. The manual covers information applicable in all regions where the product is sold. For this reason, it may contain information that is not applicable to your region.

Revision

This manual could include technical inaccuracies or typographical errors due to improvements or changes made to the product. When changes are made to the contents of the manual, Canon will release technical information when necessary. When substantial changes are made to the contents of the manual, Canon will issue a revised edition.

The following do not apply if they do not conform to the laws and regulations of the region where the manual or product is used:

Trademarks

Product and brand names appearing in this manual are registered trademarks or trademarks of the respective holders.

Copyright

All rights reserved. No parts of this manual may be reproduced in any form or by any means or translated into another language without the written permission of Canon Inc., except in the case of internal business use.

Copyright © 2005 by Canon Inc.
CANON INC.
Inkjet Device Quality Assurance Div. 2
451, Tsukagoshi 3-chome, Saiwai-ku, Kawasaki-shi, Kanagawa 212-8530, Japan



I. MANUAL OUTLINE

This manual consists of the following three parts to provide information necessary to service the PIXMA iX5000 / iX4000:

Part 1: Maintenance

Information on maintenance and troubleshooting of the PIXMA iX5000 / iX4000

Part 2: Technical Reference

New technology and technical information such as FAQ's (Frequently Asked Questions) of the PIXMA iX5000 / iX4000

Part 3: Appendix

Block diagrams and pin layouts of the PIXMA iX5000 / iX4000

Reference:

This manual does not provide sufficient information for disassembly and reassembly procedures. Refer to the graphics in the separate Parts Catalog.



II. TABLE OF CONTENTS

Part 1: MAINTENANCE

1. MAINTENANCE
 - 1-1. Adjustment, Periodic Maintenance, Periodic Replacement Parts, and Replacement Consumables by Service Engineer
 - 1-2. Customer Maintenance
 - 1-3. Product Life
 - 1-4. Special Tools
 - 1-5. Serial Number Location
2. LIST OF ERROR DISPLAY / INDICATION
 - 2-1. Operator Call Errors
 - 2-2. Service Call Errors
 - 2-3. Warnings
 - 2-4. Troubleshooting by Symptom
3. REPAIR
 - 3-1. Notes on Service Part Replacement (and Disassembling / Reassembling)
 - 3-2. Special Notes on Repair Servicing
 - 3-3. Adjustment / Settings
 - (1) Paper feed motor adjustment
 - (2) Grease application
 - (3) Waste ink counter setting
 - (4) User mode
 - (5) Service mode
 - Service test print, EEPROM initialization, Waste ink counter reset
 - Destination settings
 - 3-4. Verification Items
 - (1) Service test print
 - (2) EEPROM information print
4. PRINTER TRANSPORTATION

Part 2: TECHNICAL REFERENCE

1. NEW TECHNOLOGIES
2. CLEANING MODE AND AMOUNT OF INK PURGED
3. PRINT MODE
 - 3-1. Normal Color Printing
 - 3-2. Normal Grayscale Printing
 - 3-3. Borderless Printing
 - 3-4. Camera Direct Printing
4. FAQ (Problems Specific to the iP4000 and Corrective Actions)

Part 3: APPENDIX

1. BLOCK DIAGRAM
2. CONNECTOR LOCATION AND PIN LAYOUT
 - 2-1. Logic Board Ass'y
 - 2-2. Carriage Board (Print Head Connector)
3. PIXMA iX5000 / iX4000 Specifications

Part 1

MAINTENANCE



1. MAINTENANCE

1-1. Adjustment, Periodic Maintenance, Periodic Replacement Parts, and Replacement Consumables by Service Engineer

(1) Adjustment

Adjustment	Timing	Purpose	Tool	Approx. time
Destination settings (EEPROM settings)	At logic board replacement	To set the destination.	None. Perform in the service mode.	1 min.
Waste ink counter resetting (EEPROM settings)	- At logic board replacement - At waste ink absorber replacement	To reset the waste ink counter.	None. Perform in the service mode.	1 min.
Paper feed motor position adjustment	At paper feed motor replacement	To adjust the belt tension. (Position the paper feed motor so that the belt is stretched tight.)	None.	5 min.
Grease application	- At carriage unit replacement - At PS gear replacement	- To maintain sliding properties of the carriage shaft. - To protect the printer's sliding portions (gears).	FLOIL KG-107A	1 min.
Ink system function check	- At logic board replacement - At platen unit replacement - At carriage unit replacement	To maintain detection functionality for presence of the ink tanks and each ink tank position.	None. Perform in the service mode.	1 min.

Note: DO NOT loosen the red screws at both ends of the carriage shaft, securing the print head position, as they are not re-adjustable. The red screws securing the paper feed motor may be loosened only at replacement of the paper feed motor unit.

(2) Periodic maintenance

No periodic maintenance is necessary.

(3) Periodic replacement parts

There are no parts in this printer that require periodic replacement by a service engineer.

(4) Replacement consumables

There are no consumables that require replacement by a service engineer.

1-2. Customer Maintenance

Adjustment	Timing	Purpose	Tool	Approx. time
Print head alignment	At print head replacement.	To ensure accurate dot placement.	- Printer buttons - Computer (automatic settings via the printer driver)	3 min.
Print head cleaning	When print quality is not satisfying.	To improve nozzle conditions.	- Printer buttons - Computer (settings via the printer driver)	1 min.
Print head deep cleaning	When print quality is not satisfying, and not improved by print head cleaning.	To improve nozzle conditions.	Computer (settings via the printer driver)	2 min.
Ink tank replacement	When an ink tank becomes empty. ("No ink error" via the computer, or ink tank LED flashing fast in red)	----	----	2 min.
Paper feed roller cleaning	When necessary	To clean the paper feed rollers.	Printer buttons	2 min.
Bottom plate cleaning	When the back side of the paper is smeared	To clean the platen ribs.	- Plain paper - Computer (settings via the printer driver)	1 min.

1-3. Product Life

(1) Printer

Specified print volume (I) or the years of use (II), whichever comes first.

(I) Print volume: 24,000 pages

Black	1,500 character pattern	13,600 pages
Color	A4, 7.5% duty per color pattern	4,400 pages
	A4, photo, borderless printing	3,600 pages
	4 x 6, photo, borderless printing	600 pages
	Postcard, photo, borderless printing	1,800 pages

(II) Years of use: 5 years of use

(2) Print head

Print volume: 24,000 pages

Black	1,500 character pattern	13,600 pages
Color	A4, 7.5% duty per color pattern	4,400 pages
	A4, photo, borderless printing	3,600 pages
	4 x 6, photo, borderless printing	600 pages
	Postcard, photo, borderless printing	1,800 pages

(3) Ink tank (target value)

Pattern	Ink tank used	Print yield
Black text	PGI-5BK	Approx. 800 pages
Color chart	PGI-5BK	Approx. 1,400 pages
	CLI-8C	Approx. 710 pages
	CLI-8M	Approx. 470 pages
	CLI-8Y	Approx. 460 pages
Photo chart	PGI-5BK	Approx. 3,800 pages
	CLI-8C	Approx. 380 pages
	CLI-8M	Approx. 250 pages
	CLI-8Y	Approx. 250 pages

Black text: When printing the Canon standard pattern (1,500 characters per page) on A4 size plain paper, with the default settings in the Windows XP driver, using Word 2003.

Color chart: When printing the ISO/JIS-SCID N5 pattern on A4 size plain paper in bordered printing, with the default settings in the Windows XP driver, using Photoshop 7.0.

Photo chart: When printing the Canon standard pattern on 4" x 6" Photo Paper Plus Glossy in borderless printing, with the default settings in the Windows XP driver, using Windows XP Photo Printing Wizard.

The print yield in the table above is an average value measured in continuous printing, using the ink tank immediately after it is unsealed, until the ink is out. Ink yield may vary depending on texts and photos printed, application software, print mode, and type of paper used.

When the machine is turned on and while printing, each ink may be used for protecting the print head and maintaining print quality.

1-4. Special Tools

Name	Tool No.	Application	Remarks
FLOIL KG-107A	QY9-0057-000	To be applied to the sliding portions of the carriage shaft, and printer's sliding portions (gears).	In common with the S520.

1-5. Serial Number Location

On the carriage flexible cable holder (visible on the right of the carriage after the printer is turned on, the access cover is opened, and the carriage moves to the center).

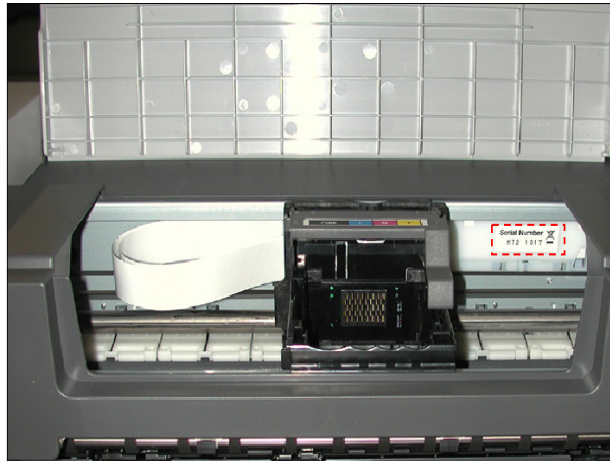

[To the table of contents](#)

[To the top](#)

[←](#) <Part 1: 1. MAINTENANCE> [→](#)

2. LIST OF ERROR DISPLAY / INDICATION

Errors are indicated by the LED, and warnings are displayed on the monitor of the computer connected to the printer.

2-1. Operator Call Errors (by Alarm LED Blinking in Orange)

Alarm LED blinking in orange	Error [Error code]	Solution	Remarks
2 times	No paper. (ASF) [1000]	Set the paper in the ASF, and press the Resume/Cancel button.	
3 times	Paper jam. [1300]	Remove the jammed paper, and press the Resume/Cancel button.	Error in paper feeding from the ASF.
	Paper output support error. [1300]	Remove any obstacles, if any, from the paper output support, and press the Resume/Cancel button.	The first time the phenomenon occurs, it is indicated as the paper output support error. The second time and thereafter (such as when the phenomenon persists even after the Resume/Cancel button is pressed), it is indicated as the PS cam sensor error (service call error).
4 times	No ink. [1600]	Replace the empty ink tank(s), or press the Resume/Cancel button.	Pressing the Resume/Cancel button will exit the error without ink tank replacement, however, ink may run out during printing.
	Ink tank not installed. [1660]	Install the applicable ink tank(s) properly, and confirm that the LED's of all the ink tanks light red.	
5 times	The print head is not installed [1401], or it is not properly installed (Print head temperature sensor error [1403] / Faulty EEPROM data of the print head [1405]).	Install the print head properly.	
7 times	Multiple ink tanks of the same color installed. [1681]	Replace the wrong ink tank(s) with the correct one(s).	
	Ink tank in a wrong position. [1680]	Install the ink tank(s) in the correct position.	
8 times	Warning: The waste ink absorber becomes almost full. [1700]	Pressing the Resume/Cancel button will exit the error, and enable printing.	The service call error, indicating the waste ink absorber is full, is likely to occur soon.
9 times	The connected digital camera or digital video camera does not support Camera Direct Printing. [2001]	Remove the cable between the camera and the printer.	
11 times	Failed in automatic print head alignment. [2500]	Press the Resume/Cancel button. - If paper is being fed at error occurrence, the error is indicated after the paper is ejected. - If the error occurs, the print head alignment values are not changed. - After exit from the error by the Resume/Cancel button, the automatic print head alignment will not be re-done.	The error is indicated when the pattern is not printed due to no ink or non-ejection of ink, or when the sensor's AD value is incorrect.
13 times	The remaining ink amount unknown. [1683]	An ink tank which has once been empty is installed. Replace the applicable ink tank with a new one.	Printing with a once-empty or refilled ink tank can damage the print head. To continue printing without replacing the ink tank, press the Resume/Cancel button for 5 sec. or longer to record the use of a refilled ink tank. Note: After the above operation, the function to detect the remaining ink amount is disabled.
14 times	Ink tank not recognized. [1684]	A non-supported ink tank is installed (the ink tank LED is turned off). Install the supported ink tanks.	

15 times	Ink tank not recognized. [1410 to 1419]	An error occurred in an ink tank (the ink tank LED is turned off). Replace the ink tank(s).
	Access cover open. [1200]	Close the access cover.

2-2. Service Call Errors (by Cyclic Blinking in Orange (Alarm LED) and Green (Power LED), or Alarm LED Lit in Orange)

Cycles of blinking in orange (Alarm LED) and green (Power LED)	Error [Error code]	Solution (Replacement of listed parts, which are likely to be faulty)
2 times	Carriage error [5100]	- Carriage unit (QM2-3361) - Timing slit strip film (QC1-8750) - Logic board ass'y (QM2-3393 / QM3-1654)*1 - Carriage motor (QK1-1500)
3 times	Line feed error [6000]	- Timing sensor unit (QM2-2683) - Timing slit disk film (QC1-4375) - Feed roller ass'y (QL2-1291) - Platen unit (QM2-3353) - Logic board ass'y (QM2-3393 / QM3-1654)*1 - Paper feed motor (QK1-1996)
4 times	Purge cam sensor error [5C00]	- Purge unit (QM2-3370) - Logic board ass'y (QM2-3393 / QM3-1654)*1
5 times	ASF (cam) sensor error [5700]	- Sheet feed unit (QM2-3367)
6 times	Internal temperature error [5400]	- Logic board ass'y (QM2-3393 / QM3-1654)*1
7 times	Waste ink absorber full [5B00]	- Ink absorber kit (QY5-0164)
8 times	Print head temperature rise error [5200]	- Print head (QY6-0064) - Logic board ass'y (QM2-3393 / QM3-1654)*1
9 times	EEPROM error [6800]	- Logic board ass'y (QM2-3393 / QM3-1654)*1
12 times	PG position error [5C10]	- Sheet feed unit (QM2-3367) - Logic board ass'y (QM2-3393 / QM3-1654)*1 - Purge unit (QM2-3370)
13 times	AH position error [5710]	- Sheet feed unit (QM2-3367) - Logic board ass'y (QM2-3393 / QM3-1654)*1 - Output support unit (QM2-3358) - Output support gear unit (QM2-3359)
14 times	PS cam sensor error [5750]	- Sheet feed unit (QM2-3367) - Logic board ass'y (QM2-3393 / QM3-1654)*1 - Output support unit (QM2-3358) - Output support gear unit (QM2-3359)
15 times	USB Host VBUS overcurrent [9000]	- Logic board ass'y (QM2-3393 / QM3-1654)*1
16 times	Valve sensor error [6C00]	- Logic board ass'y (QM2-3393 / QM3-1654)*1 - Purge unit (QM2-3370)
17 times	Motor driver error [6D00]	- Logic board ass'y (QM2-3393 / QM3-1654)*1
19 times	Ink tank position sensor error [6502]	- Platen unit (QM2-3353) - Logic board ass'y (QM2-3393 / QM3-1654)*1
20 times	Other hardware error [6500]	- Logic board ass'y (QM2-3393 / QM3-1654)*1
Continuous alternate blinking	ROM error	- Logic board ass'y (QM2-3393 / QM3-1654)*1
Alarm LED lit	RAM error	- Logic board ass'y (QM2-3393 / QM3-1654)*1

*1: Before replacement of the logic board ass'y, check the waste ink amount (by service test print or EEPROM information print). If the waste ink amount is 7% or more, also replace the ink absorber kit (QY5-0164) when replacing the logic board ass'y.

QM2-3393: iX5000 logic board ass'y

QM3-1654: iX4000 logic board ass'y

[See Section 3-3. Adjustment / Settings, (5) Service mode, for details.]

2-3. Warnings

Printer (no LED indications):

Displayed warning	Remarks
Low ink	Status indication only.
Print head temperature rise	If the print head temperature is high when the access cover is opened, the warning is displayed*1. When the print head temperature falls, the warning is released.
Protection of excess rise of the print head temperature	If the print head temperature exceeds the specified limit, a Wait is inserted during printing.

*1: If the warning is displayed, the carriage does not move to the ink tank replacement position when the access cover is opened.

2-4. Troubleshooting by Symptom

	Symptom	Solution	Remarks
Faulty operation	The power does not turn on. The power turns off immediately after power-on.	Replace the - AC adapter, or - logic board ass'y*1.	
	A strange noise occurs.	Remove foreign material, or attach a removed part if any.	
	Printing stops mid-way.	Replace the logic board ass'y*1.	
Paper feed problems	Multiple sheets feed.	Replace the sheet feed unit.	
	Paper does not feed.	Remove foreign material, or replace the sheet feed unit.	
	Paper feeds at an angle.	Remove foreign material, adjust the paper guide, or replace the sheet feed unit.	
Unsatisfactory print quality	No printing, or no color ejected.	Replace the - ink tank, - print head*2, or - logic board ass'y*1, remove foreign material from the purge unit caps, if any, or replace the purge unit.	
	Printing is faint, or white lines appear on printouts even after print head cleaning. Line(s) not included in the print data appears on printouts.	Remove and re-install the print head, or replace the - ink tank, - print head*2, - purge unit, or - logic board ass'y*1.	
	Paper gets smeared.	Feed several sheets of paper, perform bottom plate cleaning, or clean the paper path with cotton swab or cloth.	
	A part of a line is missing on printouts.	Replace the - ink tank, or - print head*2.	
	Color hue is incorrect.	Replace the - ink tank, or - print head*2, or perform print head alignment.	
	Printing is incorrect.	Replace the logic board ass'y*1.	

No ejection of black ink.	Replace the <ul style="list-style-type: none"> - ink tank, or - print head*2, or remove foreign material from the purge unit caps, if any, or replace the purge unit.
Graphic or text is enlarged on printouts.	When enlarged in the carriage movement direction, clean grease or oil off the timing slit strip film, or replace the <ul style="list-style-type: none"> - timing slit strip film, - carriage unit, or - logic board ass'y*1. When enlarged in the paper feed direction, clean grease or oil off the timing slit disk film, or replace the <ul style="list-style-type: none"> - timing slit disk film, - timing sensor unit, or - logic board ass'y*1.

*1: Before replacement of the logic board ass'y, check the waste ink amount (by service test print or EEPROM information print). If the waste ink amount is 7% or more, also replace the ink absorber kit (QY5-0164) when replacing the logic board ass'y.
[\[See Section 3-3. Adjustment / Settings, \(5\) Service mode, for details.\]](#)

*2: Replace the print head only after the print head deep cleaning is performed 2 times, and when the problem persists.

[To the table of contents](#)

[To the top](#)



3. REPAIR

3-1. Notes on Service Part Replacement (and Disassembling / Reassembling)

Service part	Notes on replacement*1	Adjustment / settings	Operation check
Logic board ass'y QM2-3393 (iX5000) QM3-1654 (iX4000)	<ul style="list-style-type: none"> - Before removal of the logic board ass'y, remove the power cord, and allow for approx. 1 minute (for discharge of capacitor's accumulated charges), to prevent damages to the logic board ass'y. - Before replacement, check the waste ink amount (by service test print or EEPROM information print). If the waste ink amount is 7% or more, also replace the ink absorber kit when replacing the logic board ass'y. <p>[See 3-3. Adjustment / Settings, (5) Service mode, for details.]</p>	<p>After replacement:</p> <ol style="list-style-type: none"> 1. Initialize the EEPROM. 2. Reset the waste ink counter. 3. Set the destination in the EEPROM. 4. Check the ink system function. <p>[See 3-3. Adjustment / Settings, (5) Service mode, for details of 1 to 4]</p> <ol style="list-style-type: none"> 5. Perform the print head alignment in the user mode. 	<ul style="list-style-type: none"> - EEPROM information print - Service test print - Printing via USB connection - Direct printing from a digital camera
Ink absorber kit QY5-0164		<p>After replacement:</p> <ol style="list-style-type: none"> 1. Reset the waste ink counter. <p>[See 3.3. Adjustment / Settings, (5) Service mode.]</p>	<ul style="list-style-type: none"> - Service test print - EEPROM information print
Carriage unit QM2-3361		<p>At replacement:</p> <ol style="list-style-type: none"> 1. Apply grease to the sliding portions. <p>[See 3-3. Adjustment / Settings, (2) Grease application.]</p> <p>After replacement:</p> <ol style="list-style-type: none"> 1. Check the ink system function. <p>[See 3.3. Adjustment / Settings, (5) Service mode.]</p> <ol style="list-style-type: none"> 2. Perform the print head alignment in the user mode. 	<ul style="list-style-type: none"> - Service test print (Confirm ink system function.)
Paper feed motor QK1-1996	<ul style="list-style-type: none"> - The red screws securing the paper feed motor are allowed to be loosened. (DO NOT loosen any other red screws.) 	<p>At replacement:</p> <ol style="list-style-type: none"> 1. Adjust the paper feed motor. <p>[See 3-3. Adjustment / Settings, (1) Paper feed motor adjustment.]</p>	
Platen unit QM2-3353		<p>After replacement:</p> <ol style="list-style-type: none"> 1. Check the ink system function. <p>[See 3-3. Adjustment / Settings, (5) Service mode.]</p>	<ul style="list-style-type: none"> - Service test print
Platen unit: QM2-3353 Carriage unit: QM2-3361 Feed roller ass'y Output support unit: QM2-3358	<ul style="list-style-type: none"> - Replace the ink absorbers (QC1-8876, QC1-8877) to the new ones, since they get torn in removal and installation of the platen unit. 	<p>After replacement:</p> <ol style="list-style-type: none"> 1. After the platen unit is installed, attach a new ink absorber to the platen unit and output support unit. <p>[See 3-2. Special Notes on Repair Servicing, (2) Platen unit removal and reassembly.]</p>	
Purge unit: QM2-3370 Waste ink tube: QC1-6458 Output support unit: QM2-3358	<ul style="list-style-type: none"> - Attach the tube cover (QC2-2480) properly. 	<p>At replacement:</p> <ol style="list-style-type: none"> 1. To protect the waste ink tube from being pinched when reassembling the printer unit chassis into the bottom case unit, attach the tube cover. <p>[See 3-2. Special Notes on Repair Servicing, (3) Printer unit assembly.]</p>	
Timing slit strip film QC1-6394	<ul style="list-style-type: none"> - Upon contact with the film, wipe the film with ethanol. - Confirm no grease is on the film. 	<p>After replacement:</p> <ol style="list-style-type: none"> 1. Perform the print head alignment in the user mode. 	<ul style="list-style-type: none"> - Service test print

Timing slit disk film QC1-6229	(Wipe off any grease thoroughly with ethanol.) - Do not bend the film.		
Print head QY6-0059		After replacement: 1. Perform the print head alignment in the user mode.	- Service test print

*1: General notes:

- Make sure that the flexible cables and wires in the harness are in the proper position and connected correctly.
[See 3-2. Special Notes on Repair Servicing, (1) Flexible cable and harness wiring, connection, for details.]
- Do not drop the ferrite core, which may cause damage.
- Protect electrical parts from damage due to static electricity.
- Before removing a unit, after removing the power cord, allow the printer to sit for approx. 1 minute (for capacitor discharging to protect the logic board ass'y from damages).
- Do not touch the timing slit strip film and timing slit disk film. No grease or abrasion is allowed.
- Protect the units from soiled with ink.
- Protect the housing from scratches.
- Exercise caution with the red screws, as follows:
 - i. The red screws of the paper feed motor may be loosened only at replacement of the paper feed motor unit (DO NOT loosen them in other cases).
 - ii. DO NOT loosen the red screws on both sides of the main chassis, securing the carriage shaft positioning (they are not adjustable in servicing).

[To the table of contents](#)

[To the top](#)

← <Part 1: 3. REPAIR; 3-1. Notes on Service Part Replacement> →

3-2. Special Notes on Repair Servicing

(1) Flexible cable and harness wiring, connection

Be cautious of wiring of the flexible cables and harness. Improper wiring or connection may cause breakage of a line, leading to ignition or emission of smoke.

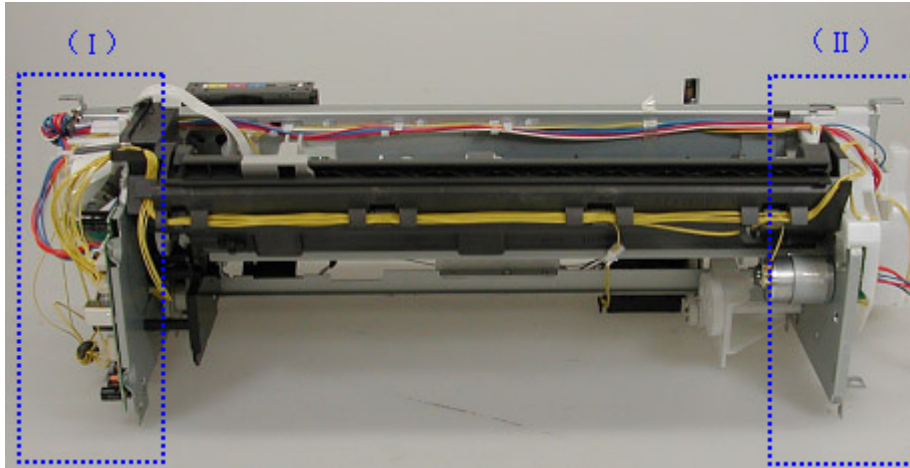

(I) Logic board ass'y wiring

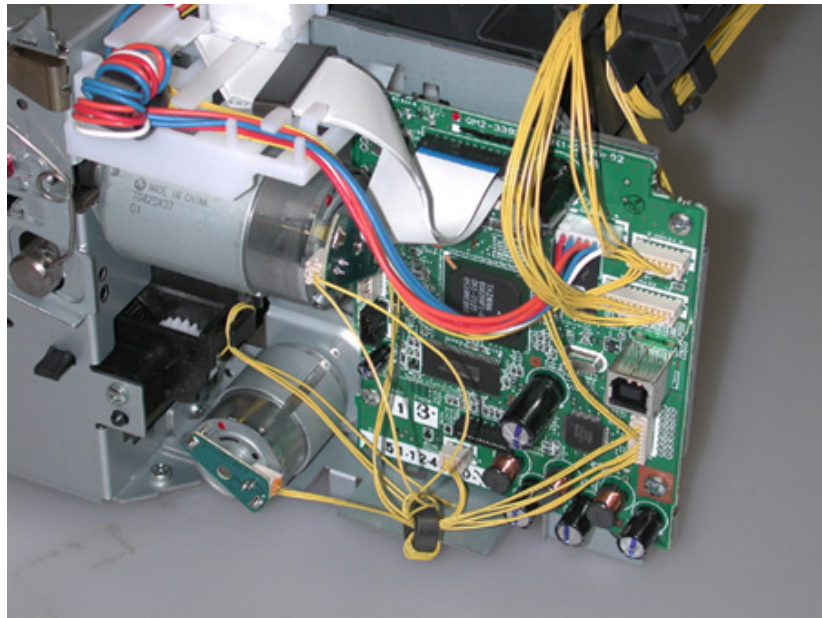

(II) Paper feed motor side wiring

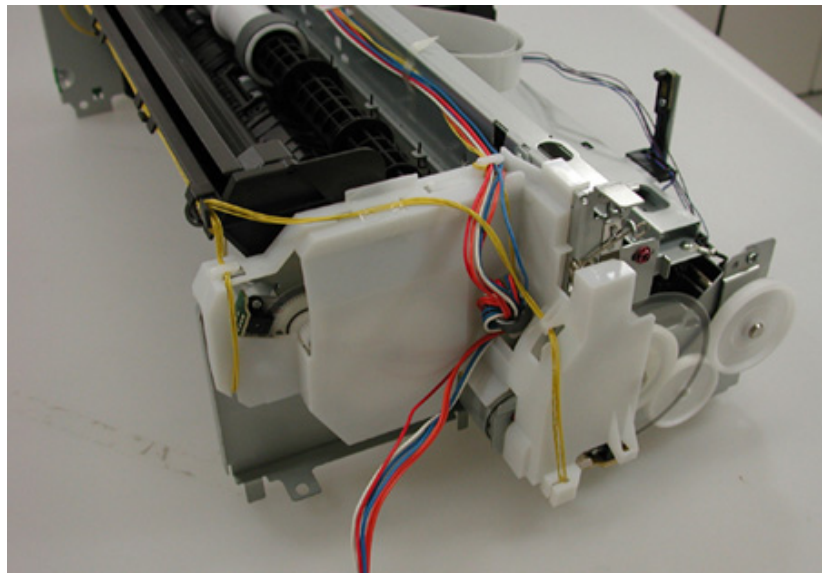

(2) Platen unit removal and reassembly

When the platen unit is removed from the printer unit, the ink absorbers* (QC1-8876, QC1-8877) will be cut. After the platen unit is assembled into the printer unit, attach new ink absorbers.

* The ink absorbers transfer ink off the paper edge in borderless printing to the waste ink absorber in the bottom case, and they are attached to the platen unit through to the output support unit.

When the platen unit is removed from the printer unit, the ink absorbers will be torn. To prevent possible ink leakage due to improper ink flow via the torn absorbers, replace the ink absorbers to the new ones.



How to attach the ink absorbers:

(I) Along the folding line marked on the absorber (the red line in the photo below), fold the ink absorber so that the double-sided adhesive will be the inside.

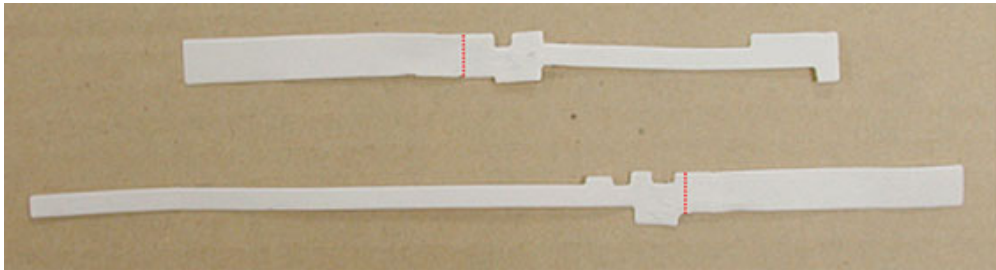

Ink absorbers folded

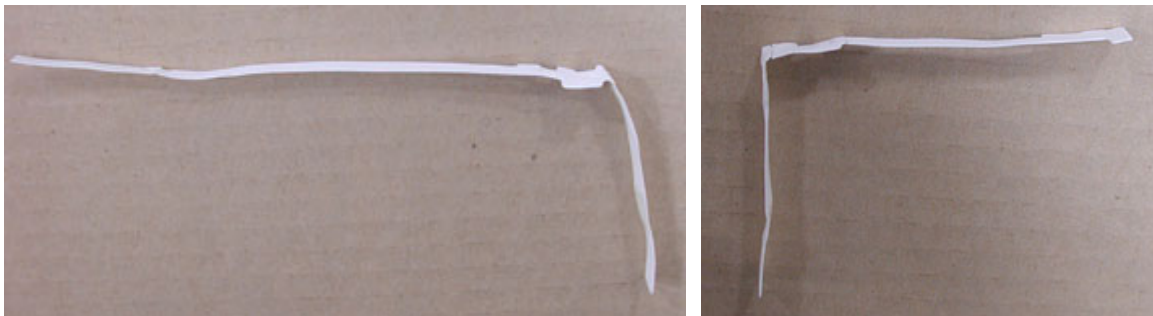

(II) Peel off the cover sheet from the adhesive tape, attach the ink absorber to the platen unit, and insert the remaining portion of the ink absorber into the slot of the platen unit (indicated by the blue circle in the photo below).



Ink absorber on the right (same as the one on the left)

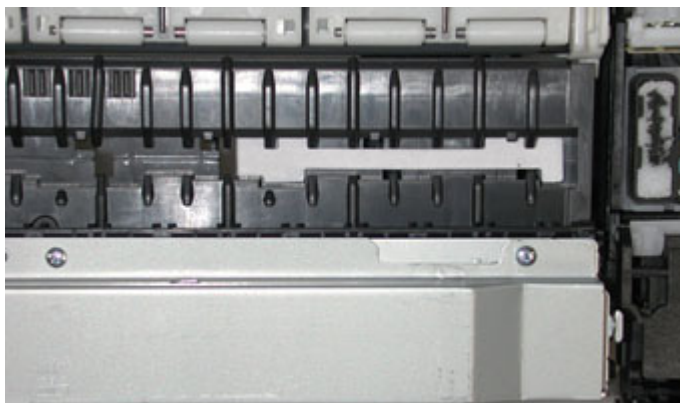

(III) Confirm that the ink absorbers come out from the slots under the output support unit (indicated by the blue circles in the photo below), then peel off the adhesive cover sheet, and attach the ink absorbers to the output support unit as shown in the photo.

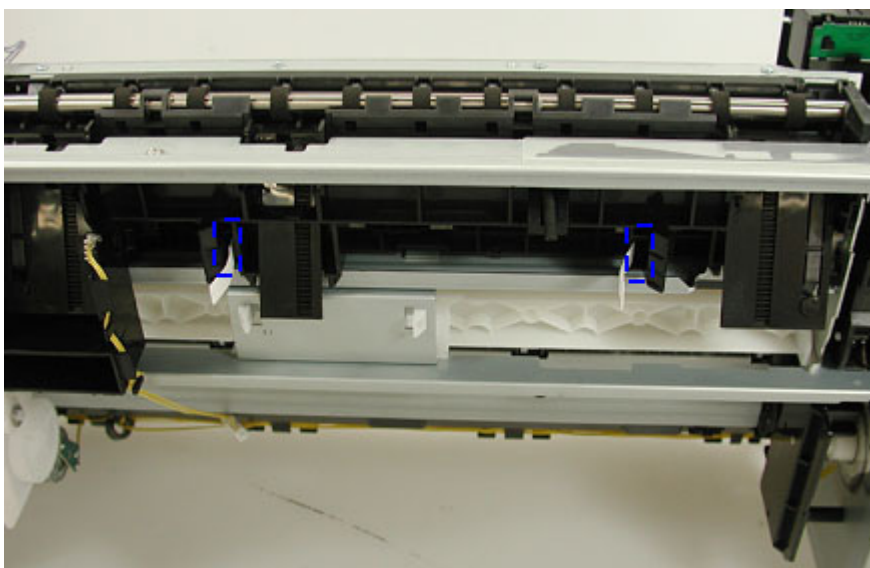

Ink absorbers attached to the output support unit

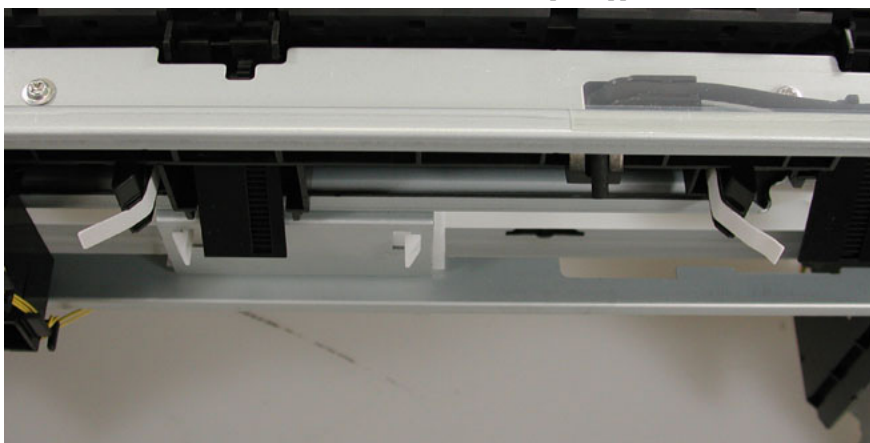

(3) Printer unit assembly

At replacement of the purge unit (QM2-3370), output support unit (QM2-3358), or waste ink tube (QC1-6458), be sure to attach the new tube cover (QC2-2480).

Without the tube cover, the tube may be pinched and blocked when assembling the printer unit into the bottom case, preventing proper purging, resulting in ink leakage or strange noise.

Tube cover location:

Align the left edge of the tube cover to the small slot, as shown in the photo below.

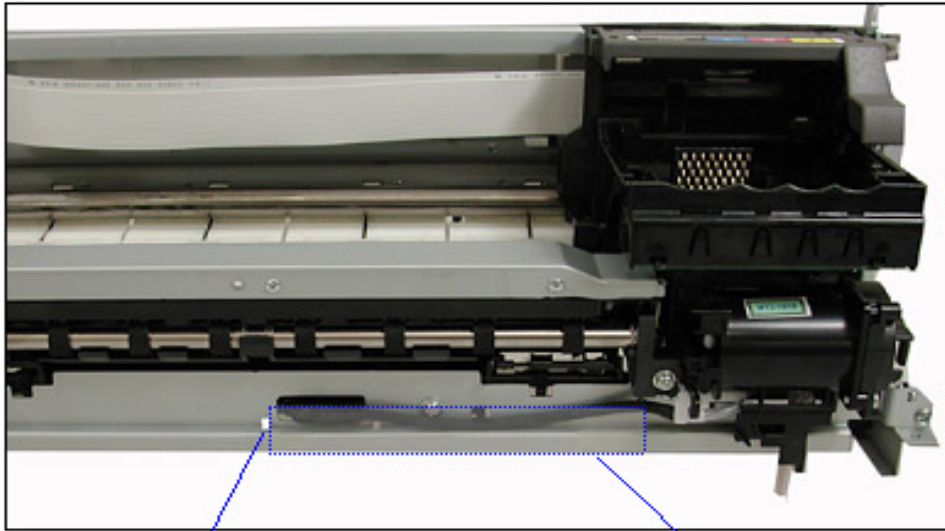

SLOT

TUBE COVER

[To the table of contents](#)

[To the top](#)

[←](#) <Part 1: 3. REPAIR; 3-2. Special Notes on Repair Servicing> [→](#)

3-3. Adjustment / Settings

(1) Paper feed motor adjustment

Perform the following adjustments when the paper feed motor unit is replaced:

- 1) When attaching the motor, fasten the screws so that the belt is properly stretched (in the direction indicated by the blue arrow in the figure below).
- 2) After replacement, be sure to perform the service test print, and confirm that no strange noise or faulty print operation (due to dislocation of the belt or gear, or out-of-phase motor, etc.) occurs.

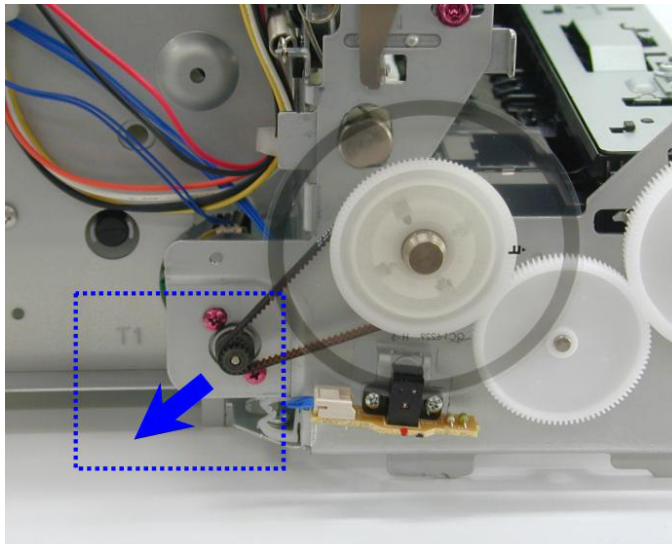

Note: The red screws securing the paper feed motor may be loosened only at replacement of the paper feed motor unit. DO NOT loosen them in other cases.

(2) Grease application

No	Part name		Where to apply grease	Grease name	Grease amount (mg)	Number of drops*	Number of locations to apply grease
1	Chassis ass'y	①	Entire surface of the slide sheet where the gap lever contacts	Floil KG107A	42 to 84	5	1
2	Carriage shaft	②	Entire surface of the carriage shaft where the carriage unit slides	Floil KG107A	270 to 530		1
3	PS gear B1	③	L Chassis B1 sliding portion	Floil KG107A	9 to 18	1	1
4	Paper Guide B1	④	Contact point of the paper guide and platen B1 on the opposite side of the home position	Floil KG107A	18 to 36	2	1

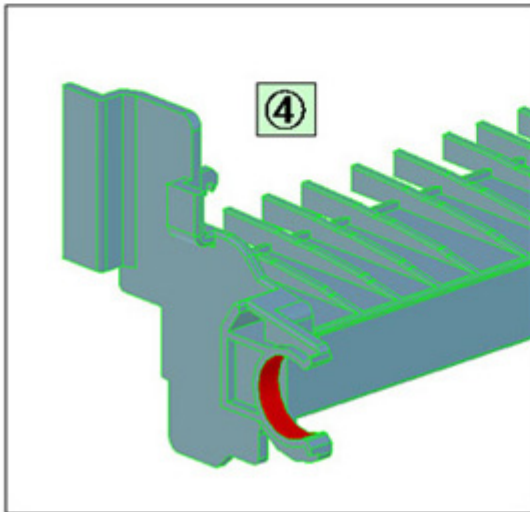
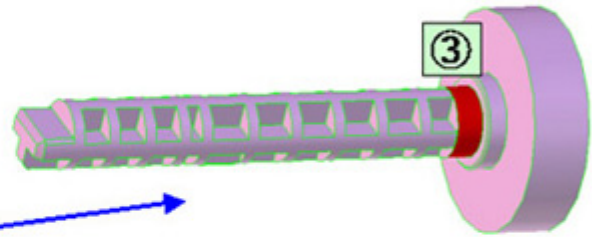
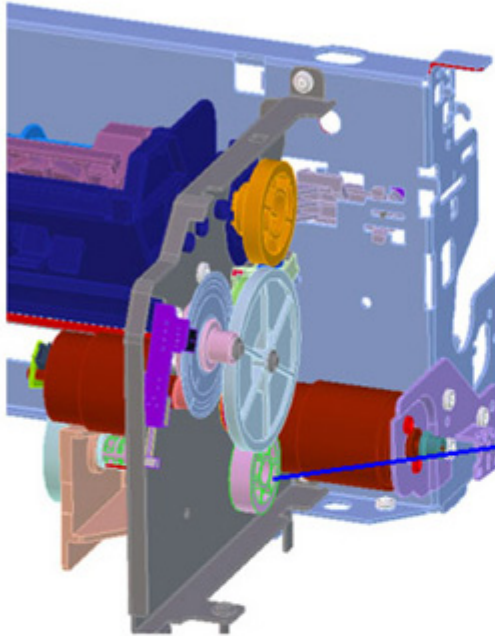
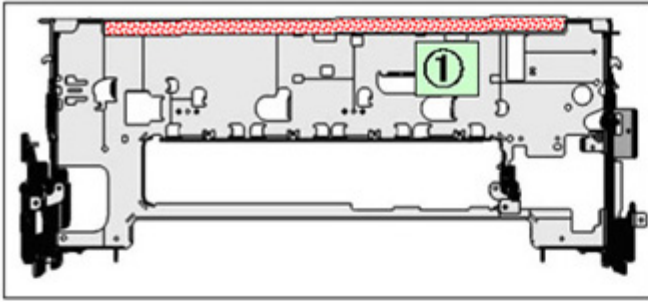

[To the table of contents](#)

[To the top](#)

[←](#) <Part 1: 3. REPAIR; 3-3. Adjustment / Settings, (1) to (2)> [→](#)

(3) Waste ink counter setting

When the logic board ass'y is replaced, reset the waste ink counter. In addition, according to the waste ink amount, replace the waste ink absorber (ink absorber kit). The standard amount for waste ink absorber replacement is given in the table below.

Waste ink amount*1	Ink absorber kit replacement
Less than 7%	Not required.
7% or more	Required.

*1: Check the waste ink amount by service test print or EEPROM information print.

[See 3.3. Adjustment / Settings, (5) Service mode, for details.]

(4) User mode

Function	Procedures	Remarks
Print head manual cleaning	- Cleaning both black and color: See "Standalone printer operation" below. - Cleaning black or color separately, or both black and color: Perform from the printer driver Maintenance tab.	
Print head deep cleaning	- Cleaning black or color separately, or both black and color: Perform from the printer driver Maintenance tab.	
Paper feed roller cleaning	See "Standalone printer operation" below.	
Nozzle check pattern printing	See "Standalone printer operation" below.	Also available from the printer driver Maintenance tab.
Print head alignment	See "Standalone printer operation" below.	In Custom Settings of the printer driver Maintenance tab, manual print head alignment (by selecting the optimum values) as with the conventional models can be performed.
Bottom plate cleaning	Perform from the printer driver Maintenance tab.	Cleaning of the platen ribs when the back side of paper gets smeared.
Print head replacement	The print head is replaceable at the same position as for ink tank replacement. (Open the access cover. When the carriage stops at the center, the print head can be replaced.)	

<Standalone printer operation>

- 1) Turn on the printer.
- 2) Press and hold the Resume/Cancel button until the Power LED blinks in green the specified number of times listed in the table below, and release it. The operation starts.

Power LED blinking	Operation	Remarks
1 time	Print head manual cleaning	
2 times	Nozzle check pattern printing	Set a sheet of plain paper (A4 or letter) in the ASF.
3 times	Paper feed roller cleaning	
4 times	Automatic print head alignment	Set a sheet of plain paper (A4 or letter) in the ASF.
5 times	Bottom plate cleaning	Fold a sheet of plain paper (A4 or letter) in half, then unfold and set it in the ASF with the folded ridge facing down.
6 times	Unspecified	
7 times	Head-to-paper distance setting to the widest	
8 times or more	Unspecified	

(5) Service mode

Function	Procedures	Remarks
Service test print - Model name - Destination - ROM version	See "Service mode operation procedures" below.	Set a sheet of A3 or LDR size paper. For print sample, see 3-4. Verification Items, (1) Service test print, <Service test print sample>.

- USB serial number - Waste ink amount - Ink system function check result		
EEPROM initialization	See "Service mode operation procedures" below.	The following items are NOT initialized, and the shipment arrival flag is not on: - USB serial number - Destination settings - Waste ink counter
Waste ink counter reset	See "Service mode operation procedures" below.	If the waste ink amount is 7% or more, replace the ink absorber kit.
Destination settings	See "Service mode operation procedures" below.	

Note: At the end of the service mode, press the Power button. The paper lifting plate of the sheet feed unit will be raised.

<Service mode operation procedures>

- 1) With the printer power turned off, while pressing the Resume/Cancel button, press and hold the Power button. (DO NOT release the buttons. The Power LED lights in green to indicate that a function is selectable.)
- 2) While holding the Power button, release the Resume/Cancel button. (DO NOT release the Power button.)
- 3) While holding the Power button, press the Resume/Cancel button 2 times, and then release both the Power and Resume/Cancel buttons. (Each time the Resume/Cancel button is pressed, the Alarm and Power LEDs light alternately, Alarm in orange and Power in green, starting with Alarm LED.)
- 4) When the Power LED lights in green*¹, press the Resume/Cancel button the specified number of time(s) according to the function listed in the table below. (Each time the Resume/Cancel button is pressed, the Alarm and Power LEDs light alternately, Alarm in orange and Power in green, starting with Alarm LED.)

Time(s)	LED indication	Function	Remarks
0 times	Green (Power)	Power off	When the print head is not installed, the carriage returns and locks in the home position capped.
1 time	Orange (Alarm)	Service test print	See 3-4. Verification Items, (1) Service test print.
2 times	Green (Power)	EEPROM information print	See 3-4. Verification Items, (2) EEPROM information print.
3 times	Orange (Alarm)	EEPROM initialization	
4 times	Green (Power)	Waste ink counter resetting	
5 times	Orange (Alarm)	Destination settings	After entering the destination settings mode, press the Resume/Cancel button the specified number of time(s) to select the destination. For detail, see "Destination settings procedures" below.
6 times	Green (Power)	Print head deep cleaning	(Cleaning of both black and color)
7 times	Orange (Alarm)	Reserved	
8 to 13 times	Green at even numbers (Power) Orange at odd numbers (Alarm)	Return to the menu selection	
14 times	Green (Power)	Reserved	
15 to 21 times* ²	Green at even numbers (Power) Orange at odd numbers (Alarm)	Return to the menu selection	

*1: If the LED does not light in green (the printer does not enter the service mode), disconnect the power cord and plug it again. Then start from step 1) to start the printer in the service mode again.

If the automatic power-on function is enabled in the printer, the printer enters the service mode for the first time, but it will never enter the service mode if the printer is turned off by the Power button. This is because the printer remains to be turned on internally if the power is turned off by the Power button. To prevent this, disconnection of the power cord is required before starting the printer in the service mode.

*2: If the Resume/Cancel button is pressed 22 or more times, the Alarm or Power LED lights steadily without any changes.

<Destination settings procedures>

In the destination settings mode, press the Resume/Cancel button the specified number of time(s) according to the destination listed in the table below, and press the Power button.

Time(s)	LED indication	Destination
0 times	Green (Power)	No change of the destination
1 time	Orange (Alarm)	Japan
2 times	Green (Power)	Korea
3 times	Orange (Alarm)	US
4 times	Green (Power)	Europe
5 times	Orange (Alarm)	Australia
6 times	Green (Power)	Asia
7 times	Orange (Alarm)	China
8 times	Green (Power)	Taiwan
9 times or more	Orange (Alarm)	Return to the menu selection

Note: After setting the destination, confirm the model name and destination in service test print or EEPROM information print.
[See 3.4. Verification Items, (1) Service test print, or (2) EEPROM information print.]

[To the table of contents](#)

[To the top](#)

 <Part 1: 3. REPAIR; 3-3. Adjustment / Settings, (3) to (5)> 

3-4. Verification Items

(1) Service test print

<EEPROM information contents>

On the service test print (sample below), confirm the EEPROM information as shown below. (The information is given in the upper portion of the printout.)

iX5000 (iX4000): Model name

JPN: Destination

Vx.xx: ROM version

USB (xxxxxx): USB serial number

FA = xx xx xx: Reserved for plant use

D = xxx.x: Waste ink amount (%)

AB (C = OK Y = ...): Ink system check result

Note: The waste ink amount should be confirmed by EEPROM information print (not by service test print).

<Print check items>

On the service test print (sample below), confirm the following items:

- Check 1, top of form accuracy: The lines shall not extend off the paper.
- Check 2, EEPROM information
- Check 3, nozzle check pattern: Ink shall be ejected from all nozzles.
- Check 4, check pattern for uneven printing due to line feeding: There shall be no remarkable streaks or unevenness.
- Check 5, check pattern for uneven printing due to carriage movement (standard mode): There shall be no remarkable unevenness.
- Check 6, check pattern for uneven printing due to carriage movement (highest print quality mode): There shall be no remarkable unevenness.
- Check 7, check pattern for paper thickness lever operation: The line shall slide at the center.
- Check 8, check pattern for straight line and carriage accuracy: There shall be no misalignment or breakage of the lines.

<Service test print sample>

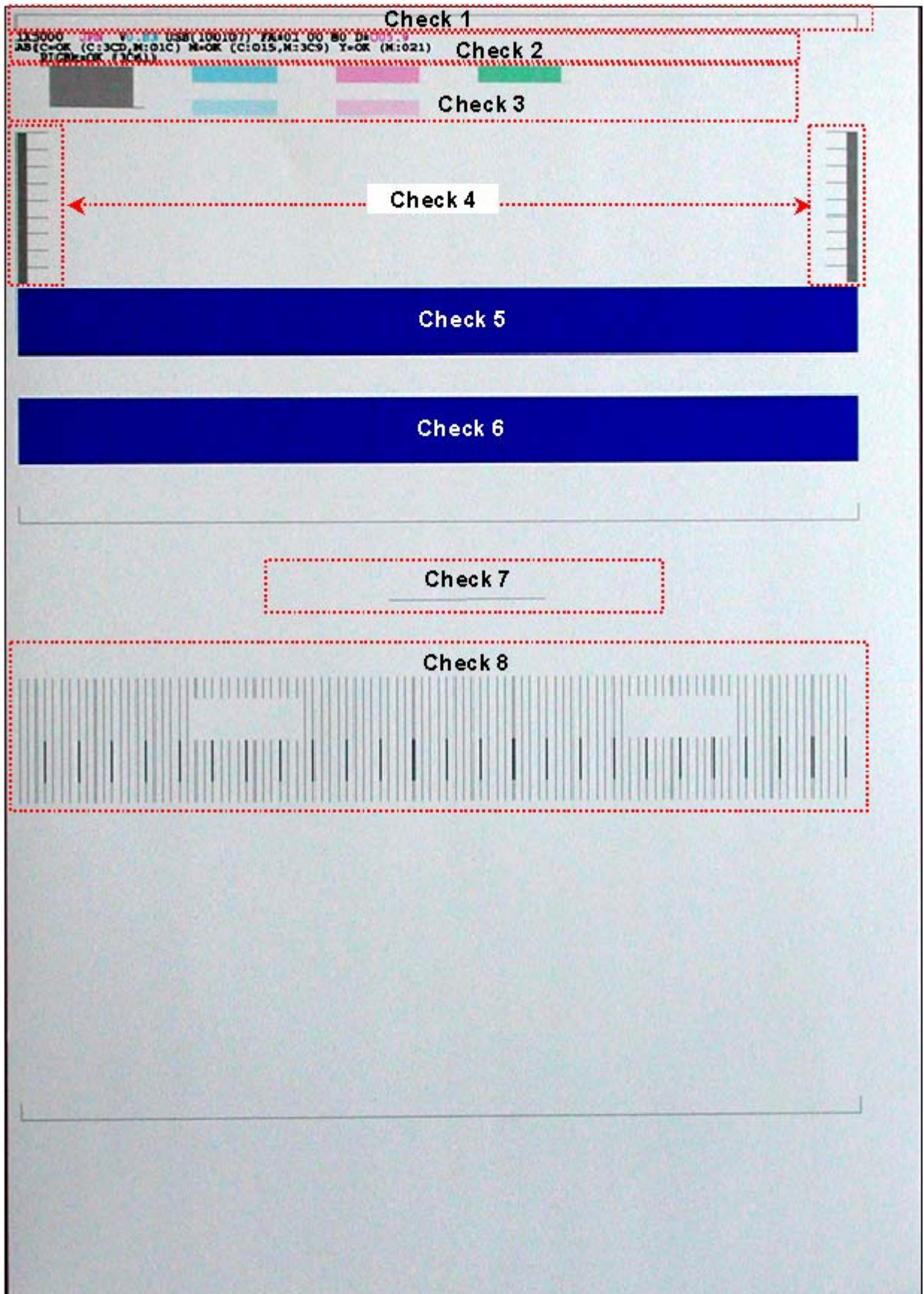

(2) EEPROM information print

<How to read EEPROM information print>

Print sample:

iX5000 JPN V1.04 IF(USB2=1) D=004.5 ST=2005/12/27-18:30
ER(ER0=1000 ER1=5100) LPT=2006/02/09-09:09
PC(M=002 R=000 T=001 D=009 C=009)
CLT(BK=2006/02/25-18:30 CL=2006/02/25-18:30)
CH=00002 CT(PBK=040 C=109 M=012 Y=113) IS(PBK=1 C=1 M=1 Y=1)
P_ON(S=00009) A_REG=1 M_REG=0
UR(A(BKoe)=000 B(Coe)=000 C(Moe)=000 D(SCoe)=000 E(SMoe)=000
F(BKbi)=000 G(CLbi)=000 H(BK-CL)=000 I(SCLbi)=000 J(C-SC)=000 K(S-SM)=000
L(NZctr)=000 M(NZedge)=000

WP=0024 CDIN(PB=000) MSD(015)
PAGE(All=00083 PP=00035 HR+MP=00003 PR+SP+SG =00000 GP =00000 PC=00000 EV=00000)
CDPAGE(All=00000 A3=00000 A4=00000) EDGE=(All=00000 A3=00000 A4=00000)
SIZE=(A3=00020 A4=00050) 2L=00000) L=00000 PC=00013)
Head TempBK=18.5 Head TempC=17.5 Env Temp=30.0 FF(3F 3F 3F)

HDEEPROM
V0001 SN=0318-A43D
LN(00000 00000 00001 00003 00001 00000 00000) ID=00
IL=(PBK=000 BK=000 Y=001 M=001 M2=001 C=000 C2=001)

Printed items:

1. Model name
2. ROM version
3. Connected I/F (USB2)
4. Waste ink amount
5. Installation date
6. Operator call/service call error record
7. Last printing time
8. Purging count (manual/deep cleaning/timer/dot count/ink tank replacement)
9. Cleaning time (BK/CL)
10. Print head replacement count
11. Ink tank replacement count (PBK/Y/M/C)
12. Ink status (PBK/Y/M/C)
13. Power-on count (soft)
14. Automatic print head alignment by user
15. Manual print head alignment by user
16. User print head alignment values (Bkoe/Coe/Moe/SCoe/SMoe/ Bkbi/CLbi/BK-CL/SCLbi/C-SC/M-SM/ NZctr/NZedge)
17. Wiping count
18. Camera Direct Print-supported device connection record
19. Longest period where printing stops
20. ASF feed pages (total, plain paper, High Resolution Paper & Matte Photo Paper, Photo Paper Pro & Photo Paper Plus Glossy & Photo Paper Plus Semi-gloss, Glossy Photo Paper, postcard, envelope)
21. Camera Direct print pages (total, A3, A4)
22. Borderless print pages (total, A3, A4)
23. Print pages by paper size (A3, A4, 5x6, 4x6, postcard)
24. Print head temperature (BK/CL)
25. Inside temperature
26. Line inspection information

HDEEPROM
27. Version
28. Serial number
29. Lot number
30. Print head ID
31. Ink ejection level (PBK, Y, M, M2, C, C2)

[To the table of contents](#)

[To the top](#)

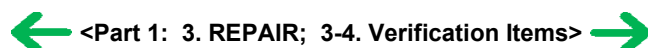

4. PRINTER TRANSPORTATION

This section describes the procedures for transporting the printer for returning after repair, etc.

- 1) In the service mode, press the Power button to finish the mode, and confirm that the paper lifting plate of the sheet feed unit is raised.
- 2) Keep the print head and ink tanks installed in the carriage.
[See Caution 1 below.]
- 3) Turn off the printer to securely lock the carriage in the home position. (When the printer is turned off, the carriage is automatically locked in place.)
[See Caution 2 below.]

Caution:

- (1) If the print head is removed from the printer and left alone by itself, ink (especially the pigment black ink) is likely to dry. For this reason, keep the print head installed in the printer even during transportation.
- (2) Securely lock the carriage in the home position, to prevent the carriage from moving and applying stress to the carriage flexible cable, or causing ink leakage, during transportation.

Memo:

If the print head must be removed from the printer and transported alone, perform the following:

- (1) Attach the protective cap (used when the packing was opened) to the print head (to protect the print head face from damage due to shocks).

[To the table of contents](#)

[To the top](#)



Part 2

TECHNICAL REFERENCE



1. NEW TECHNOLOGIES

(1) New ink tank system (PGI-5, CLI-8)

An LED is installed in each ink tank.

By the LED indication, wrong installation of the ink tanks will be prevented, and the remaining ink level can be visually recognized with the ink tanks seated in the carriage.

The combination of the new pigment-based black ink with higher resistance against bleeding or marker pens and the new dye-based inks with higher photo quality and weather resistance makes the new ink system strong in both photo and text printing.

(2) Super-photo quality printing

By the FINE technologies, 2 pl of ultra-fine ink droplet is adopted. The iX5000 / iX4000 provides excellent super-photo print quality without graininess at the maximum resolution of 4,800 dpi x 1,200 dpi^{*1}, which is equal to that of a 6-color printer.

*1: Printing at the minimum distance of 1/4800 inch between the dots.

(3) Speed

Approx. 42 sec. in 4 x 6 borderless printing (standard mode, Photo Paper Pro, Full Page SCID No.2)

For reference:

iX5000: 25 ppm in monochrome print and 17 ppm in color print

iX4000: 18 ppm in monochrome print and 14 ppm in color print

(4) Direct Printing Function

The Camera Direct Print standard, PictBridge, is supported.

The Bubble Jet Direct is not supported..

(5) USB 2.0 Hi-Speed supported

The iX5000 / iX4000 supports USB 2.0 Hi-Speed, enabling high speed data transfer in use with the computer, OS, and USB hub. However, the parallel I/F (IEEE1284) is removed.

(6) Borderless printing supported (iX4000)

The iX4000 supports borderless printing, which the i6100 (the least-expensive in the existing A3 models) does not support.

[To the table of contents](#)

[To the top](#)



2. CLEANING MODE AND AMOUNT OF INK PURGED

To prevent printing problems due to bubbles, dust, or ink clogging, print head cleaning is performed before the start of printing (when the cleaning flag is on), except in the following cases:

- Cleaning on arrival: Performed when the access cover is closed.
- Manual cleaning / deep cleaning: Performed manually.

<Cleaning mode list>

Black: Pigment-based black

Color: Dye-based cyan, magenta, yellow

Condition	Details	Amount of ink used (g) (in the normal temperature/humidity environment)	Est. required time (sec.) (not including the time of opening the caps)
On arrival of the printer (All in sequence)	First to third cleaning after shipped from the plant.	0.65 (Black) 1.54 (Color)	85
Dot count cleaning (Black)	When the specified number of dots are printed since the previous Black cleaning.	0.20 (Black)	35 (Black)
Timer cleaning - 0* ¹ (Black only)	If 24 to 60 hours have elapsed since the previous Black cleaning till the start of the next printing.	0.20 (Black)	35 (Black)
Timer cleaning - 1 (Black only)	If 60 to 120 hours have elapsed since the previous Black cleaning till the start of the next printing.		
Timer cleaning - 2* ² (Black/Color)	If 120 to 336 hours have elapsed since the previous Black/Color cleaning till the start of the next printing.	0.20 (Black) 0.60 (Color)	35 (Black) 40 (Color)
Timer cleaning - 3 (All in sequence)	If 336 to 1,080 hours have elapsed since the previous Black/Color cleaning till the start of the next printing.	0.65 (Black) 1.07 (Color)	70
Timer cleaning - 4 (All in sequence)	If 1,080 to 2,160 hours have elapsed since the previous Black/Color cleaning till the start of the next printing.	1.08 (Black) 1.07 (Color)	70
Timer cleaning - 5 (All in sequence)	If 2,160 to 4,320 hours have elapsed since the previous Black/Color cleaning till the start of the next printing.	2.02 (Black) 1.07 (Color)	70
Timer cleaning - 6 (All in sequence)	If 4,320 or longer hours have elapsed since the previous Black/Color cleaning till the start of the next printing.	2.02 (Black) 1.07 (Color)	70
At print head replacement (All in sequence)	When the print head is removed and installed.	0.65 (Black) 1.54 (Color)	85
At ink tank replacement* ³ (Black/Color/All in sequence)	When an ink tank is replaced (without the print head removal or re-installation)	0.40 (Black) 1.07 (Color)	65 (All in sequence) 35 (Black) 55 (Color)
Manual cleaning (Black/Color/All at the same time)	- Via the operation panel (All at the same time only) - Via the printer driver (Selectable from Black, Color, or All at the same time)	0.20 (Black) 0.60 (Color)	35 (All at the same time) 30 (Black) 30 (Color)
Deep cleaning (Black/Color/All at the same time)	Via the printer driver (Selectable from Black, Color, or All at the same time)	2.02 (Black) 1.07 (Color)	75 (All at the same time) 40 (Black) 55 (Color)
If the print head has not been capped before power-on (All in sequence)		0.40 (Black) 1.07 (Color)	65 (All in sequence)

- *1: When 24 to 60 hours have elapsed since the previous Black cleaning, timer cleaning - 0 is performed. However, this cleaning will be conducted up to 5 times from the printer installation, and no further timer cleaning - 0 will be performed.
- *2: The period of time since the previous cleaning is counted by Black and Color separately. For this reason, the cleaning mode may differ according to Black or Color.
- *3: If a black ink is removed for 10 seconds or longer, Black cleaning is performed.

If one of the color ink tanks is removed for 60 seconds or longer, Color cleaning is performed.

(Cleaning is performed according to the period of time an ink tank is removed from the print head, regardless of whether the ink tank is actually replaced or not. If the same ink tank is removed and installed back multiple number of times, cleaning is performed based on the accumulated period of time the ink tank is removed.)

In the above condition, when only the black ink tank is removed, Black cleaning is performed. When one of the color ink tanks is removed, Color cleaning is performed. Both the black and color ink tanks are removed, All-at-the-same-time cleaning is performed.

[To the table of contents](#)

[To the top](#)

 <Part 2: 2. CLEANING MODE AND AMOUNT OF INK PURGED> 

3. PRINT MODE

	Default setting
	Selectable in the printer driver Main tab
	Selectable after clicking Custom in the Main tab

Ink used BK: PGI-5BK
 C: CLI-8C(5pl)
 M: CLI-8M(5pl)
 Y: CLI-8Y(5pl)
 c: CLI-8C(2pl)
 m: CLI-8M(2pl)

Print control Bi Bi-directional
 Uni Uni-directional

3-1. Normal Color Printing

Paper type	Item	Printer driver Custom setting				
		5	4	3	2	1
Plain paper	Print quality Print control Ink used & resolution	Custom 1pass, Bi BK : 300x300 YMC :600x600	Fast 1pass, Bi BK : 300x300 YMC : 600x600	Standard 1pass, Bi BKY : 600x600 MC : 1200x1200	High 4passes, Bi BK : 600x600 YMCmc : 1200x1200	
Photo Paper Pro (PR-101)	Print quality Print control Ink used & resolution			Standard 4passes, Bi YMC : 1200x1200 mc : 1200x1200	High 6passes, Bi YMC : 1200x1200 mc : 1200x1200	Custom 16passes, Bi YMC : 2400x1200 mc : 4800x1200
Photo Paper Plus Glossy Photo Paper Plus Semi-gloss (PP-101/SG-101)	Print quality Print control Ink used & resolution		Fast 3passes, Bi YMC : 1200x1200 mc : 1200x1200	Standard 4passes, Bi YMC : 1200x1200 mc : 1200x1200	High 6passes, Bi YMC : 1200x1200 mc : 1200x1200	
Photo Paper Plus Double sided (PP-101D)	Print quality Print control Ink used & resolution			Standard 4passes, Bi YMC : 1200x1200 mc : 1200x1200	High 6passes, Bi YMC : 1200x1200 mc : 1200x1200	
Matte Photo Paper (MP-101)	Print quality Print control Ink used & resolution			Standard 4passes, Bi YMC : 1200x1200 mc : 1200x1200	High 6passes, Bi YMC : 1200x1200 mc : 1200x1200	
Glossy Photo Paper (GP-401/501)	Print quality Print control Ink used & resolution			Standard 4passes, Bi YMC : 1200x1200 mc : 1200x1200	High 6passes, Bi YMC : 1200x1200 mc : 1200x1200	
High Resolution Paper (HR-101)	Print quality Print control Ink used & resolution			Standard 4passes, Bi YMC : 1200x1200 mc : 1200x1200	High 6passes, Bi YMC : 1200x1200 mc : 1200x1200	
Envelope	Print quality Print control Ink used & resolution			Standard 3passes, Bi BKY : 600x600 MC : 1200x600	High 4passes, Bi BK : 600x600 YMCmc:1200x1200	
T-Shirt Transfer (TR-301)	Print quality Print control Ink used & resolution			Standard 6passes, Bi YMC : 1200x1200		
Transparency (CF-102)	Print quality Print control Ink used & resolution			Standard 2passes, Bi BK : 600x600 YMC : 1200x1200	High 6passes, Bi BK : 600x600 YMC : 1200x1200	
Other photo paper (swellable polymer paper)	Print quality Print control Ink used & resolution			Standard 8passes, Bi YMC : 1200x1200 mc : 1200x1200		

3-2. Normal Grayscale Printing

Paper type	Item	Printer driver Custom setting				
		5	4	3	2	1
Plain paper	Print quality Print control Ink used & resolution	Custom 1pass, Bi BK : 300x300	Fast 1pass, Bi BK : 300x300	Standard 1pass, Bi BK : 600x600	High 4passes, Bi BK:600x600	
Envelope	Print quality Print control Ink used & resolution			Standard 2passes, Uni BK : 600x600	High 4passes, Uni BK : 600x600	

3-3. Borderless Printing

Paper type	Item	Printer driver Custom setting				
		5	4	3	2	1
Plain paper	Print quality Print control Ink used & resolution			Standard 2passes, Bi Y : 600x600 MC : 1200X1200		
Photo Paper Pro (PR-101)	Print quality Print control Ink used & resolution			Standard 4 pass, Bi YMC: 1200x1200 mc : 1200x1200	High 6passes, Bi YMC : 1200x1200 mc : 1200x1200	Custom 16passes, Bi YMC : 2400x1200 mc : 4800x1200
Matte Photo Paper (MP-101)	Print quality Print control Ink used & resolution			Standard 4passes, Bi YMC : 1200x1200 mc : 1200x1200	High 6passes, Bi YMC : 1200x1200 mc : 1200x1200	
Photo Paper Plus Glossy Photo Paper Semi-gloss (PP-101/SG-101)	Print quality Print control Ink used & resolution		Fast 3passes, Bi YMC : 1200x1200 mc : 1200x1200	Standard 4passes, Bi YMC : 1200x1200 mc : 1200x1200	High 6passes, Bi YMC : 1200x1200 mc : 1200x1200	
Glossy Photo Paper (GP-401/501)	Print quality Print control Ink used & resolution			Standard 4passes, Bi YMC : 1200x1200 mc : 1200X1200	High 6passes, Bi YMC : 1200x1200 mc : 1200x1200	
Photo Paper Plus Double sided (PP-101D)	Print quality Print control Ink used & resolution			Standard 4passes, Bi YMC : 1200x1200 mc : 1200x1200	High 6passes, Bi YMC : 1200x1200 mc : 1200x1200	

3-4. Camera Direct Printing

Paper type	Item	Printer driver Custom setting				
		5	4	3	2	1
Plain paper	Print quality Print control Ink used & resolution				High 4passes, Bi BK :600x600 YMCmc : 1200x1200	
Photo Paper Pro (PR-101)	Print quality Print control Ink used & resolution				High 6 ass, Bi CMY : 1200x1200 mc : 1200x1200	
Photo Paper Plus Glossy Photo Paper Plus Semi-gloss (PP-101/SG-101)	Print quality Print control Ink used & resolution				High 6passes, Bi CMY : 1200x1200 mc : 1200x1200	

[To the table of contents](#)

[To the top](#)



4. FAQ (Problems Specific to the iX5000 / iX4000 and Corrective Actions)

No.	*	Function	Phenomenon	Condition	Cause	Corrective action	Possible call or complaint
1	A	Print results	Soiling on the back side of paper (lines or streaks parallel to the paper feed direction)	<ul style="list-style-type: none"> - After continuous borderless printing of small sized paper (such as 4 x 6), when a larger sized paper (such as A4) is printed. - With Photo Paper Plus Double Sided or postcards, the phenomenon is likely to be noticeable and to be complained of by users, as printing is performed on both sides of such paper. 	In borderless printing, printing is performed to the size slightly larger than the paper size, and ink off the paper is absorbed by the platen's ink absorber. Absorbed ink may attach to the platen rib(s) after several dozen sheets are printed, causing soiling at the leading edge of paper or on the back side of paper.	<ol style="list-style-type: none"> 1. Perform Bottom plate cleaning (from the printer driver) up to 3 times*1. 2. If soiling on the paper still remains after 3 times of Bottom plate cleaning, wipe the platen rib(s) and their surroundings with a cotton swab. 	<ul style="list-style-type: none"> - Paper gets smeared. - The back side of paper gets smeared.
2	C	Setup	Carriage error during setup	- The protective material is not removed from inside the printer, when the printer is turned on.	A user missed the step to remove the protective material which is given in the Easy Setup Instructions.	While following the instructions in the Easy Setup Instructions, pull the tape to remove the right and left protective material, then turn the printer off and turn it on again.	<ul style="list-style-type: none"> - An error occurs. - The Power and Alarm lamps alternately blink 2 times. - A strange noise is heard.

*1: Change the paper in each Bottom plate cleaning. The cleaning can end when paper does not get any soiling.

* Occurrence level:

A: The symptom is likely to occur frequently. (Caution required)

B: The symptom may occur under certain conditions, but likeliness is assumed very low in practical usage.

C: The symptom is unlikely to be recognized by the user, and no practical issues are assumed.

[To the table of contents](#)

[To the top](#)

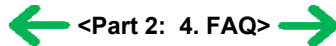

Part 3

APPENDIX



1. BLOCK DIAGRAM

1-1. PIXMA iX5000 / iX4000

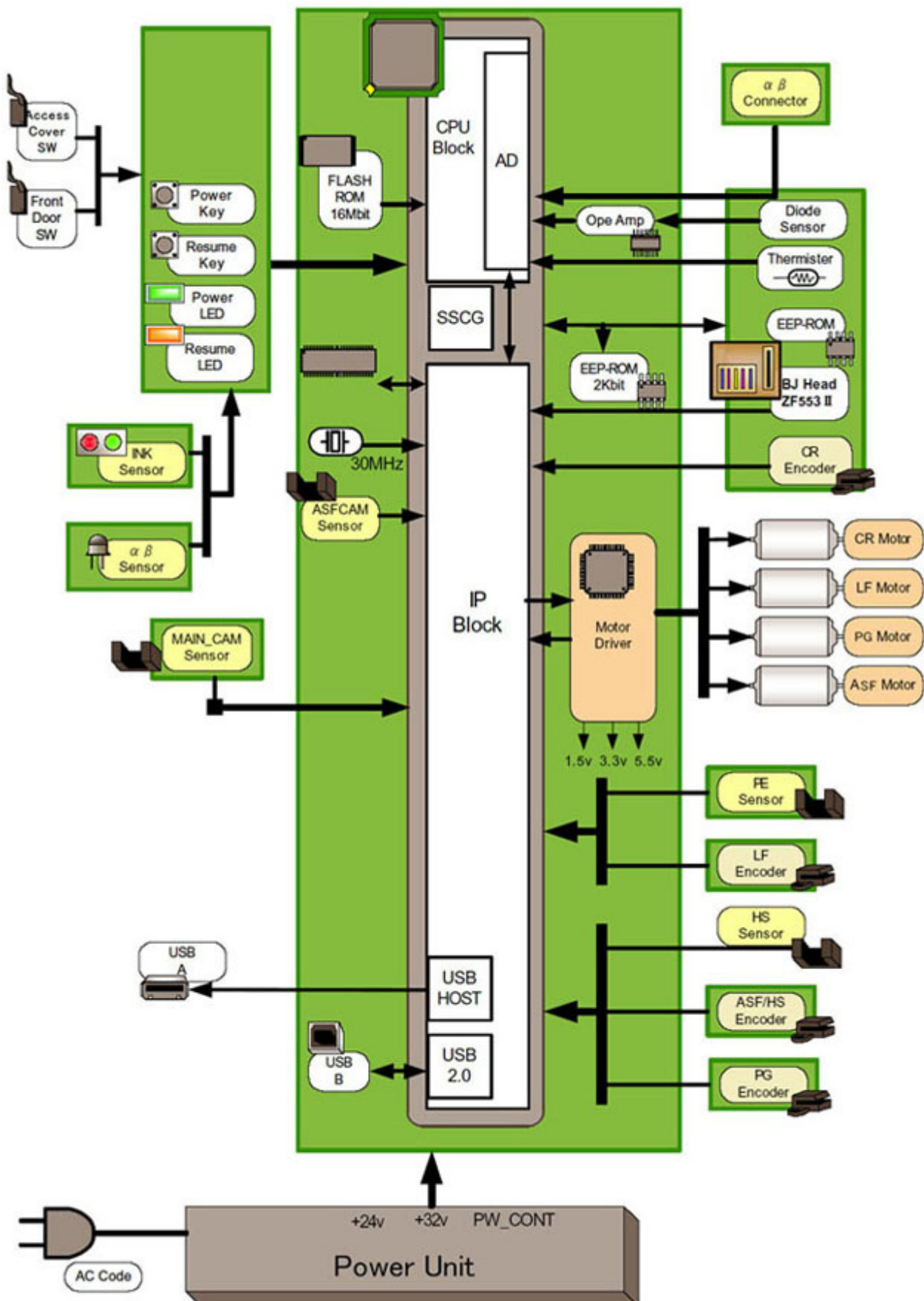

[To the table of contents](#)

[To the top](#)

[← Part 3: 1. BLOCK DIAGRAM →](#)

2. CONNECTOR LOCATION AND PIN LAYOUT

2-1. Logic Board Ass'y

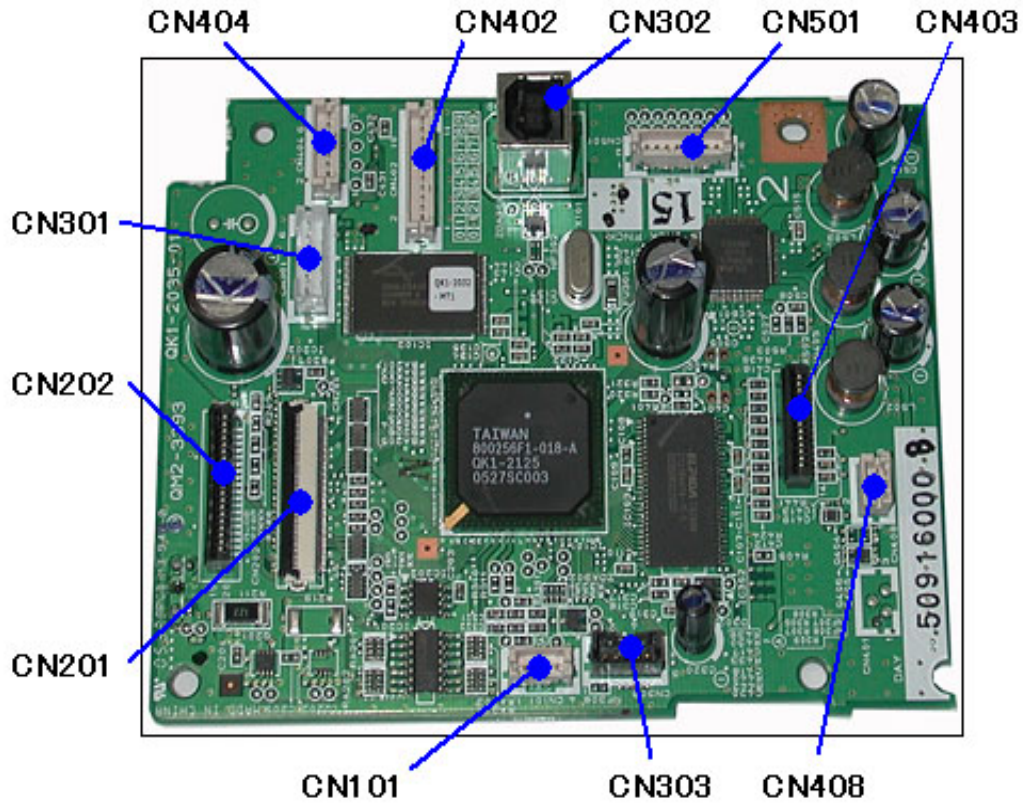

CN101 Not used

CN201 (Print head 1/2 [Carriage unit])

No.	Signal name	Function	Input / Output
1	AB_PWR	AB power supply	-
2	AB_DATA	AB data signal	BUS
3	AB_PWR	AB power supply	-
4	AB_CLK	AB clock signal	BUS
5	LOGIC_GND	Logic ground	-
6	H_D3	Head data (SC1)	OUT
7	H_D0	Head data (BK1)	OUT
8	H_D1	Head data (BK2)	OUT
9	H_D5	Head data (SM1)	OUT
10	H_ENB0	Head heat enable signal 0 (BK)	OUT
11	LOGIC_GND	Logic ground	-
12	DIA0	Diode sensor anode 0	IN
13	LOGIC_GND	Logic ground	-
14	H_D2	Head data (C1)	OUT
15	H_D4	Head data (M1)	OUT
16	H_ENB3	Head heat enable signal 3 (SCol)	OUT
17	H_D8	Head data (Y1)	OUT
18	H_ENB1	Head heat enable signal 1 (Col-1)	OUT
19	H_LATCH	Head data latch signal	OUT
20	H_EEPROM_CS	Head EEPROM chip select signal	OUT

21	H_EEPROM_SK	Head EEPROM serial clock signal	OUT
22	H_D10	Head data (SM2)	OUT
23	LOGIC_GND	Logic ground	-
24	H_CLK	Head data transfer clock signal	OUT
25	H_EEPROM_DIO	Head EEPROM data signal	OUT
26	H_D12	Head data (SC2)	OUT
27	H_D6	Head data (PBK1)	OUT
28	LOGIC_GND	Logic ground	-
29	CR_ENCB	Carriage encoder phase B	IN
30	LOGIC_GND	Logic ground	-
31	CR_ENCA	Carriage encoder phase A	IN
32	LOGIC_GND	Logic ground	-
33	DIA1	Diode sensor anode 1	IN
34	LOGIC_GND	Logic ground	-
35	H_D7	Head data (PBK2)	OUT
36	H_D11	Head data (M2)	OUT
37	H_D9	Head data (Y2)	OUT
38	H_D13	Head data (C2)	OUT
39	SNS_CDR_P	CDR position sensor signal (not used)	-
40	THERMO	Carriage temperature sensor signal	IN
41	DIK	DIK (Logic ground)	-
42	H_ENB2	Head heat enable signal 2 (Col-2)	OUT
43	VSEN_CDRS	Power supply for CDR sensor (not used)	-
44	VSEN_3.3V	Power supply for sensor 3.3V	OUT
45	LOGIC_GND	Logic ground	-

CN202 (Print head 2/2 [Carriage unit])

No.	Signal name	Function	Input / Output
1 to 3	H_GND	Head ground	-
4 to 6	HVH_24V	Head drive power supply 24V	OUT
7 to 10	H_GND	Head ground	-
11 to 12	HVH_16V	Head drive power supply 16V	OUT
13 to 16	HVH_24V	Head drive power supply 24V	OUT
17	LOGIC_GND	Logic ground	-
18	HVDD_3.3V	Head logic drive power supply 3.3V	OUT
19	LOGIC_GND	Logic ground	-
20	HVDD_3.3V	Head logic drive power supply 3.3V	OUT

CN301 (AC adapter)

No.	Signal name	Function	Input / Output
1	VH1	Head power supply	IN
2	H1_GND	Head ground	-
3	VM	Motor power supply	IN
4	VM	Motor power supply	IN
5	M_GND	Motor ground	-
6	PW_CONT	Power supply control signal	OUT

CN302 (USB I/F)

No.	Signal name	Function	Input / Output
1	SNS_USB	USB: VBUS power supply sense	IN
2	D-	USB: D- signal	BUS
3	D+	USB: D+ signal	BUS
4	GND	Ground	-
5 to 9	GND	Ground	-

CN303 (DSC harness)

No.	Signal name	Function	Input / Output
1	GND	Ground	-
2	GND	Ground	-
3	D+	DSC-USB: D+ signal	BUS
4	D-	DSC-USB: D- signal	BUS
5	PWR	DSC-USB: VBUS signal	OUT

CN402 (Sensor multi 1 harness)

No.	Signal name	Function	Input / Output
1	VSEN_3.3V	Power supply for sensor 3.3V	OUT
2	GND	Ground	-
3	SNS_PF_PE	PF/PE sensor	IN
4	GND	Ground	-
5	APCL_ENCA	APCL encoder phase A	IN
6	VSEN_3.3V	Power supply for sensor 3.3V	OUT
7	APCL_ENCB	APCL encoder phase B	IN
8	GND	Ground	-
9	PF_ENCA	PF encoder phase A	IN
10	VSEN_3.3V	Power supply for sensor 3.3V	OUT
11	PF_ENCB	PF encoder phase B	IN

CN403 (Operation panel ass'y)

No.	Signal name	Function	Input / Output
1	RESUME_SW	Resume/Cancel button switch	IN
2	LED_BIN1	Bin 1 LED display (not used)	-
3	LED_RESUME (ORANGE)	Resume/Cancel LED display	OUT
4	LED_BIN2	Bin 2 LED display (not used)	-
5	POW_SW	Power button switch	IN
6	BIN_SW	Bin switch (not used)	-
7	LED_POWER(GREEN)	Power LED display	OUT
8	GND	Ground	-
9	SNS_FRONT_CVR	Front cover sensor	IN
10	AB_POW	Power supply for AB	OUT

11	DOOR	Door sensor	IN
12	AB_SNS	AB sensor	IN
13	INK_CDRS_PWM	CD-R LED control signal (not used)	-
14	SNS_INKS	Ink sensor	IN

CN404 (PE sensor / LF encoder harness)

No.	Signal name	Function	Input / Output
1	VSEN_3.3V	Power supply for sensor 3.3V	OUT
2	GND	Ground	-
3	SNS_PE	Paper empty sensor	IN
4	GND	Ground	-
5	LF_ENCA	LF encoder phase A	IN
6	VSEN_3.3V	Power supply for sensor 3.3V	OUT
7	LF_ENCB	LF encoder phase B	IN

CN408 (Main_cam)

No.	Signal name	Function	Input / Output
1	VSEN_3.3V	Power supply for sensor 3.3V	OUT
2	GND	Ground	-
3	SNS_MAIN_CAM	Main cam sensor	IN

CN501 (Motor multi harness)

No.	Signal name	Function	Input / Output
1	CR_M	CR motor +	OUT
2	CR_MN	CR motor -	OUT
3	PF_MN	PF motor -	OUT
4	PF_M	PF motor +	OUT
5	AP_M	AP motor +	OUT
6	AP_MN	AP motor -	OUT
7	LF_M	LF motor +	OUT
8	LF_MN	LF motor -	OUT

[To the table of contents](#)

[To the top](#)

← <Part 3: 2. CONNECTOR LOCATION AND PIN LAYOUT; 2-1. Logic Board Ass'y> →

2-2. Carriage Board (Print Head Connector)

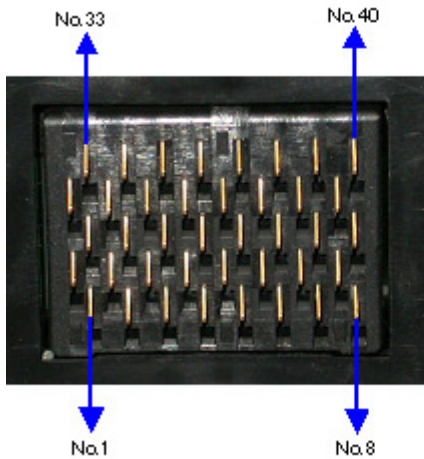

No.	Signal name	Function	Input / Output
1, 2	A_GNDH	Head ground	-
3	HD2_C1	Head data C1	OUT
4	HD8_Y1	Head data Y1	OUT
5	VSS	Logic ground	-
6	HD6_PBK1	Head data PBK1	OUT
7, 8	B_GNDH	Head ground	-
9	HD3_SC1	Head data SC1	OUT
10	HD5_SM1	Head data SM1	OUT
11	HD4_M1	Head data M1	OUT
12	HENB1	Head heat enable signal 1	OUT
13	HD10_SM2	Head data SM2	OUT
14	VSS	Logic ground	-
15	HD11_M2	Head data M2	OUT
16	DIK	Diode sensor cathode	IN
17	HD0_K1	Head data BK1	OUT
18	HENB0	Head heat enable signal 0	OUT
19	HENB3	Head heat enable signal 3	OUT
20	HLAT	Head data latch signal	OUT
21	HD12_SC2	Head data SC2	OUT
22	HD7_PBK2	Head data PBK2	OUT
23	HD9_Y2	Head data Y2	OUT
24	HENB2	Head heat enable signal 2	OUT
25	HD1_K2	Head data BK2	OUT
26	DIA0	Diode sensor anode 0	IN
27	HVDD_3.3V	Head logic power supply 3.3V	OUT
28	ROM_CS	Head EEPROM chip select signal	OUT
29	HCLK	Head clock signal	OUT
30	ROM_DIO (O)	Head EEPROM data signal	IN
31	HD13_C2	Head data C2	OUT
32	B_VH_16V	Head drive power supply 16V	OUT

33,34	A_VH_24V	Head drive power supply 24V	OUT
35	HVDD_3.3V	Head logic power supply 3.3V	OUT
36	ROM_SK	Head EEPROM serial clock signal	OUT
37	ROM_DIO (I)	Head EEPROM data signal	OUT
38	DIA1	Diode sensor anode 1	IN
39	VHT	Head drive power supply 24V	OUT
40	B_VH_24V	Head drive power supply 24V	OUT

[To the table of contents](#)

[To the top](#)

[<Part 3: 2. CONNECTOR LOCATION AND PIN LAYOUT; 2-2. Carriage Board>](#)

3. PIXMA iX5000 / iX4000 Specifications

<Printer>

Type	Desktop serial color bubble jet printer																															
Paper feeding method	Auto sheet feed																															
Resolution	4,800 x 1,200dpi (Max.)																															
Throughput (target value)	- 4 x 6, borderless printing: Approx. 42 sec. (standard mode, PR-101, Full Page SCID No. 2) - Camera Direct Printing: Approx. 79 sec. (4 x 6, borderless printing, PP-101, default settings) For reference: <table border="0" style="width: 100%; border-collapse: collapse;"> <tr> <td style="width: 30%;"><u>iX5000</u></td> <td style="width: 20%; text-align: center;">Max Speed</td> <td style="width: 20%; text-align: center;">Standard</td> <td style="width: 30%;"></td> </tr> <tr> <td>Black (Fine Black)</td> <td style="text-align: center;">25ppm</td> <td style="text-align: center;">12.3ppm</td> <td></td> </tr> <tr> <td>Color (Fine Color)</td> <td style="text-align: center;">17ppm</td> <td style="text-align: center;">9.6ppm</td> <td></td> </tr> <tr> <td colspan="4"> </td> </tr> <tr> <td><u>iX4000</u></td> <td style="text-align: center;">Max Speed</td> <td style="text-align: center;">Standard</td> <td></td> </tr> <tr> <td>Black (Fine Black)</td> <td style="text-align: center;">18ppm</td> <td style="text-align: center;">11.4ppm</td> <td></td> </tr> <tr> <td>Color (Fine Color)</td> <td style="text-align: center;">14ppm</td> <td style="text-align: center;">9.0ppm</td> <td></td> </tr> </table>				<u>iX5000</u>	Max Speed	Standard		Black (Fine Black)	25ppm	12.3ppm		Color (Fine Color)	17ppm	9.6ppm						<u>iX4000</u>	Max Speed	Standard		Black (Fine Black)	18ppm	11.4ppm		Color (Fine Color)	14ppm	9.0ppm	
<u>iX5000</u>	Max Speed	Standard																														
Black (Fine Black)	25ppm	12.3ppm																														
Color (Fine Color)	17ppm	9.6ppm																														
<u>iX4000</u>	Max Speed	Standard																														
Black (Fine Black)	18ppm	11.4ppm																														
Color (Fine Color)	14ppm	9.0ppm																														
Printing direction	Bi-directional, uni-directional																															
Print width	Max. 322.2mm (329mm in borderless printing)																															
Interface	USB 2.0 Hi-Speed																															
ASF stacking capacity	Plain paper: Max. 13mm (Approx. 150 sheets of 64g/m ² paper)																															
Paper weight	64 to 105g/m ²																															
Detection functions	Access cover open, Presence of print head / ink tanks, Opening / Closing of front door, Remaining ink amount (optical / dot count), Printing position, Paper presence, Paper end sensor, Waste ink amount, Internal temperature, Pick-up roller, Paper feed roller position, Carriage position, Head-to-paper distance, Supported camera direct printing device																															
Acoustic noise (Highest print quality)	- Highest print quality settings: Approx. 36.6dB - Quiet mode: Approx. 35.2dB																															
Environmental requirements	During operation	Temperature	5C to 35C (41F to 95F)																													
		Humidity	10%RH to 90%RH (no condensation)																													
	Non operation	Temperature	0C to 40C (32F to 104F)																													
		Humidity	5%RH to 95%RH (no condensation)																													
Power supply	Power supply voltage, frequency	Power consumption	Standby	Power-off																												
	AC 100 to 240V, 50/60Hz	Approx. 17W	Approx. 0.8W	Approx. 0.5W																												
External dimensions	Printer: With the paper support and output tray retracted: Approx. 601 (W) x 318 (D) x 194 (H)mm With the paper support and output tray extended: Approx. 601 (W) x 839 (D) x 372 (H)mm																															
Weight	Approx. 9.3kg, not including print head and optional units																															
Related standards (Printer, Adapter)	Electromagnetic radiance: VCCI, CE Mark, SATO, Gost-R, C-Tick, CCC (EMC), Korea (MIC) Electrical safety: Electrical Appliance and Material Safety Law (DENAN), CB Report, CE Mark, GS, Gost-R, FT, SASO, CCC, SPRING, RPC, Korea EK Environmental regulations: RoHS (EU), WEEE (EU), Korea Package Recycle Law, Green Point (Germany), Energy Star, Blue Angel, Eco Mark, Law on Promoting Green Purchasing																															
Serial number location	On the carriage flexible cable holder (visible on the right of the carriage after the printer is turned on, the access cover is opened, and the carriage moves to the center.)																															
Remaining ink amount detection	Available (automatic detection by optical method and dot count, enabled at default)																															
Paper type detection	Not available																															
Print head alignment	Available (automatic or manual alignment via driver utilities, or automatic alignment via the Resume/Cancel button in Camera Direct Printing, automatic alignment at default)																															

<Print head>

Type	Single head with 4 removable ink tanks (each color)
Print head	Black: 320 nozzles (600dpi), 30pl (pigment-based black) Color: 256 nozzles x 5 (1,200dpi), 2pl / 5pl (cyan, magenta), 5pl (yellow)
Ink color	Pigment-based black, Dye-based cyan, magenta, yellow
Ink tank	PGI-5BK (pigment-based), CLI-8C/M/Y (dye-based)
Weight (Net)	Print head, approx. 56g
Supply method	As a service part (not including ink tanks)
Part number	QY6-0064-000

<Supported ink tanks>

Model name and destination		Pigment-based ink		Dye-based ink					
		PGI-5BK	BCI-9BK	CLI-8C	CLI-8M	CLI-8Y	BCI-7eC	BCI-7eM	BCI-7eY
PIXMA iX5000 / iX4000	Other than Japan	O	X	O	O	O	X	X	X
PIXUS iX5000	Japan	X	O	X	X	X	O	O	O

O: Usable

X: Not usable

Note: The ink tanks for the Japanese models are not compatible with those for the non-Japanese models. Be sure to use the appropriate ink tanks in servicing.

[To the table of contents](#)

[To the top](#)



<Part 3: 3. PIXMA iX5000 / iX4000 Specifications>