



LBP6680x / LBP6670dn

Before You Start	11
Legal Notices	12
Legal Limitations on the Usage of Your Product and the Use of Images	14
Using the e-Manual	15
How to Use the e-Manual	16
Operating Environment	17
Installing the e-Manual	18
Uninstalling the e-Manual	21
Screen Layout of the e-Manual	22
Top Page	23
Topic Page	25
Contents Page	26
Search Method	27
Viewing the e-Manual	28
Disclaimer	30
Copyright	31
Trademarks	32
Important Safety Instructions	33
Installation	34
Power Supply	36
Handling	37
Maintenance and Inspections	39
Consumables	41
Others	42
About This Printer	43
Printer Specifications	44
Introduction of the Optional Accessories	48
Names and Dimensions of Each Part	50
Control Panel	54
Introduction of the Utilities	57
Energy-saving Mode	59
Cautions for Handling the Printer	60
Consumables	61
Maintenance	62
Toner Cartridge Replacement	63
Attention (Toner Cartridge)	65
Before Replacing the Toner Cartridge	67
Replacing the Toner Cartridge	69
Storing Toner Cartridges	72
Adjusting the Printing Position	73
Adjusting the Printing Position for All the Jobs	74
Adjusting the Printing Position for Each Paper Source	76
Moving the Printer	81
Cleaning and Maintaining the Printer	84
Cleaning the Inside of the Printer	85
Cleaning the Fixing Roller of the Printer	86
Cleaning the Outside of the Printer	89
Attention (Cleaning)	91
Location of the Serial Number	92

Printer Installation	93
Attention (Printer Installation)	95
Confirming the Supplied Accessories and Checking the Installation Site	97
Removing the Packing Materials	99
Installing the Paper Feeder	104
Installing the Printer	109
Installing ROM	112
Installing ROM	113
Checking the ROM Installation	118
Removing ROM	120
Installing SD Card (LBP6680x Only)	121
Installing SD Card	122
Checking the SD Card Installation	126
Removing SD Card	128
Specifying the Printer's Initial Settings	129
Turning the Power On and Specifying a Language	130
Specifying a Type of Printer Driver	132
Connecting to a Computer	134
Installing the Software	137
For Windows	138
Selecting the Appropriate Printer Driver	139
Installation	140
Other Software Programs	141
For Macintosh	142
Installation	143
Basic Printer Operations	144
Usable Paper	145
Precautions for Paper	148
Printable Area	150
Paper Loading and Output	152
Loading Paper in the Paper Drawer	154
Attention (Paper Drawer)	157
Loading Custom Size Paper	158
Loading Paper in the Multi-purpose Tray	161
Attention (Multi-purpose Tray)	164
Registering the Paper Size	165
Configuring the Printer Driver and Printing	167
Attention (Printer Driver Configuration)	171
Turning the Printer ON/OFF	172
Attention (Turning the Printer ON/OFF)	175
Online and Offline	176
Canceling a Job	178
Operations from the Computer	179
Cancelling from the Printer Control Panel	181
Outputting Data (Forced Output)	183
Canceling the Process Currently Being Performed (Soft Reset)	185
Canceling All the Jobs (Hard Reset)	186
Checking the Printer Status	187
Printing on Various Types of Paper	188

Printing on Plain Paper, Heavy Paper, or Index Card	189
Printing on Transparencies	190
Printing on Labels	191
Printing on Envelopes	192
Printing on Custom Size Paper	194
Paper Loading Orientation	195
Useful Printing Functions	197
Printing from a Computer (Windows)	199
Printing Fundamentals	200
Printing with the Printer Driver	201
Configuring the Print Settings Beforehand	203
Setting the Printer Options	205
Viewing the Online Help	207
Printing Functions	208
Common Functions	209
[Page Setup] Sheet	210
[Finishing] Sheet	211
[Paper Source] Sheet	212
[Quality] Sheet	213
[Device Settings] Sheet	214
Scaling Documents	215
Printing Multiple Pages on One Sheet	217
1-sided Printing and 2-sided Printing	219
Attention (1-sided Printing and 2-sided Printing)	222
Booklet Printing	223
Poster Printing	226
Watermark Printing	228
Combining and Printing Multiple Files	230
Selecting a Profile for Printing	233
Registering a Profile for Printing	234
Printing from a Computer (Macintosh)	236
Printing Fundamentals	237
Printing with the Printer Driver	238
Configuring the Page Settings Beforehand	241
Setting the Printer Options	243
Viewing the Online Help	246
Viewing the Driver Guide	248
Printing Functions	249
Common Functions	250
[Layout] Preferences Pane	251
[Finishing] Preferences Pane	252
[Paper Source] Preferences Pane	253
[Quality] Preferences Pane	254
[Special Features] Preferences Pane	255
Scaling Documents	256
Printing Multiple Pages on One Sheet	258
1-sided/2-sided Printing	260
Using [Presets] for Printing	263
Setting Priority (When Specifying the Same Item Using Multiple Methods)	265

Functions Which Can Be Specified from the Control Panel	266
Printing without the Printer Driver (Direct Print)	267
Printing the PDF File Using the Direct Print Function	269
Printing the PS/EPS File Using the Direct Print Function	276
Printing the TIFF/JPEG File Using the Direct Print Function	280
Printing the XPS File Using the Direct Print Function (LBP6680x Only)	286
Direct Printing from Command Prompt	292
Printing Files Directly from USB Memory Devices (USB Direct Print) (LBP6680x Only)	293
Printing Directly from USB Memory Device	294
Print Setting Menu List	297
Changing the Default Print Settings and File Sorting Criteria	300
Remove the USB Memory Device	301
Receiving E-mail Data on the Mail Server and Printing (E-mail Print)	303
Printing a Fax Document Transferred from a Multi-function Machine	306
How to Specify the Settings for E-mail Print	307
Attention (How to Specify the Settings for E-mail Print)	311
Receiving and Printing E-mails Manually	313
Printing the E-mail Receive Log List	316
Attention (Printing E-mail Sending/Receiving History)	318
When E-mail Print Fails	319
Printing Files from the Printer Using FTP Client	322
Specifying a Password for a Document and Printing (Secured Print) (LBP6680x Only)	324
Attention (Specifying a Password for a Document and Printing (Secured Print))	326
Saving a Document in the SD Card in the Printer (Stored Job Print) (LBP6680x Only)	327
Performing a Stored Job Print Using the Control Panel of the Printer	328
Displaying or Operating the Jobs Stored in a Box (Resume/Delete)	330
Automatically Deleting Files Stored in a Box	334
Changing the Box Settings	337
Giving Priority to a Print Job (Interrupt Printing) (LBP6680x Only)	341
Configuring the Network Settings (Sharing the Printer)	342
Checking Your Network Environment	344
Example of a Windows Network	345
Example of a Macintosh Network	347
Example of a UNIX Network	348
Example of a Network Using a Variety of Computers	349
Network Settings for the Printer (Common to Each Protocol)	350
Changing the Network Transmission Speed or Transfer Mode	351
Performing the Configuration Using the Printer's Control Panel (When You First Set it Up)	352
Changing the Settings Using Web Browser (Remote UI)	354
Setting the Spooling Function (LBP6680x Only)	358
Performing the Configuration Using the Printer's Control Panel (the Settings to Be Performed First)	359
Changing the Settings Using Web Browser (Remote UI)	361
Specifying the Setting for Startup Waiting Time	365
Performing the Configuration Using the Printer's Control Panel	366
Changing the Settings Using Web Browser (Remote UI)	368
Restricting the Users Who Can Monitor/Change the Settings Using the SNMP Protocol	372
Setting IEEE802.1X Authentication	384
Setting TLS Authentication Information	385
Setting TTLS/PEAP Authentication Information	391

Network Setting Items	397
Initializing the Network Settings	410
Initializing the Network Settings Using the Printer's Control Panel	411
Checking the MAC Address	412
Network Settings for the Printer (TCP/IP)	416
Setting the IP Address (IP v. 4)	417
Setting the IP Address Using the Printer's Control Panel	418
Setting the Printer to a Static IP Address	421
Determining Which IP Address to Assign to the Printer	423
Setting the IP Address Using the ARP/PING Commands	424
Setting the IP Address Using NetSpot Device Installer	426
Configuring the Protocol Settings	427
Attention (Protocol Settings)	452
Setting IP v. 6	454
Configuring a Computer that Performs Printing	462
Features of LPD	463
Features of RAW	464
Features of IPP/IPPS	465
Features of WSD	466
Connecting the Printer (LPD/RAW)	467
Values for Setting a Port	474
Connecting the Printer (IPP/IPPS)	475
Obtaining the Public Key for This Printer When Using SSL Encrypted Communication	481
Connecting the Printer (WSD)	483
Network Settings for the Printer (NetWare) (LBP6680x Only)	484
Attention (NetWare Network Settings)	485
Configuring NetWare	486
Configuring the Protocol Settings	490
Network Settings for the Printer (SMB) (LBP6680x Only)	495
Attention (SMB Network Settings)	496
Configuring the Protocol Settings	497
Configuring a Computer that Performs Printing	506
Network Settings for the Printer (AppleTalk)	510
Macintosh Network Settings	511
Configuring the Protocol Settings	513
FTP Client (Macintosh)	519
Configuring a Computer that Performs Printing	521
Managing the Printer	522
Software That Can Be Used for Managing the Printer	523
Remote UI	524
Starting the Remote UI	525
Attention (Remote UI)	528
Enabling the Remote UI	529
Screen Layout of the Remote UI (Details on Each Setting Page)	531
Display/Change Message Board Messages and Support Links	550
FTP Client	553
NetSpot Device Installer	556
Managing Print Jobs	557
Attention (Job Manager)	560

Control Panel Setting	561
Attention (Control Panel Setting)	563
Setting Items	564
[Setup] Menu ([Control Menu] Options)	565
[Setup] Menu ([Paper Source] Options)	569
[Setup] Menu ([Network] Options)	571
[Setup] Menu ([Layout] Options)	576
[Setup] Menu ([Quality] Options)	578
[Setup] Menu ([Interface] Options)	580
[Setup] Menu ([User Maintenance] Options)	581
[Setup] Menu ([Print Mode] Options)	584
[Setup] Menu ([UFR II] Options)	585
[Setup] Menu ([PCL] Options)	586
[Setup] Menu ([Imaging] Options)	588
[Setup] Menu ([XPS] Options) (LBP6680x Only)	589
[Setup] Menu ([PDF] Options)	590
[Setup] Menu ([PS] Options)	591
[Setup] Menu ([MEAP Settings] Options) (LBP6680x Only)	592
[Setup] Menu ([Check Counter] Options)	593
[Utility Menu] Menu	594
[Job] Menu	596
[Reset] Menu	597
[Select Feeder] Menu	598
Checking the Number of the Printed Pages	600
Importing and Exporting Settings	603
Initializing the Settings	607
Initializing the [Setup] Menu Using the Printer's Control Panel	608
Checking the Printer Settings	610
Setting the Administrator Password	612
Specifying the Device Name or Administrator Information	615
Sleep Mode	619
Auto Shutdown	621
Printing Silently	625
Performing Printing Always with Silent Mode	626
Performing Printing with Silent Mode during a Designated Time	628
Specifying an ID for Each Department (LBP6680x Only)	630
Register/Update Software Function (LBP6680x Only)	632
Available Functions	633
Installing the System Options/MEAP Applications	634
Installing by Connecting This Printer to an Outside Network (Delivery)	635
Installing by Not Connecting This Printer to an Outside Network (Manual)	638
Downloading the Manuals and Related Software	644
Updating the Firmware	645
Managing the Register/Update Software Function	655
Security Settings	658
Restricting the Users Who Can Print or Perform the Printer Settings	659
Restricting the Users Who Can Access	669
Setting Restrictions for Print Jobs	675
Specifying the Job Operation Permission for End-Users	679

Locking the Keys on the Control Panel (Key Lock Function)	683
Setting Restrictions for USB Direct Print (LBP6680x Only)	687
Setting Keys and Certificates	691
Displaying the [Key and Certificate Settings] Page in the Remote UI	692
Newly Creating a Key and Its Certificate	694
Installing a Key/Certificate File on the Printer	700
Registering a Key and Its Certificate in the Printer	702
Checking a Certificate	705
Deleting a Key and Its Certificate	706
Setting CA Certificates	707
Displaying the [CA Certificate Settings] Page in the Remote UI	708
Installing CA Certificate Files on the Printer	710
Registering CA Certificates in the Printer	712
Checking CA Certificates	713
Deleting CA Certificates	714
Setting the SSL Encryption Communication Function	715
Selecting Keys and Certificates	716
Changing the Remote UI Settings	719
Setting the IPsec Encryption Communication Function (LBP6680x Only)	723
Displaying the [IPsec Settings] Page on the Remote UI	724
Adding a New Security Policy	726
Editing Security Policies	734
Enabling IPsec Encryption Communication	736
Specifying the Setting for Job Log Display	738
MEAP (LBP6680x Only)	742
Available Functions	743
Launching and Closing SMS	745
Before Launching SMS (Preparation)	746
Setting Up HTTP Communication	747
Launching SMS (Log in)	749
Attention (Launching SMS (Log in))	753
Closing SMS (Logging Out)	754
MEAP Application Settings	755
Installing MEAP Applications	758
Attention (Installing MEAP Applications)	761
Uninstalling MEAP Applications	762
Starting/Stopping MEAP Applications	764
Starting MEAP Applications	765
Stopping MEAP Applications	766
Checking the Details of MEAP Applications	768
MEAP Application License Settings	770
Adding License Files	771
Disabling License Files	774
Downloading Disabled License Files	777
Deleting Disabled License Files	780
Setting Authentication Information for MEAP Applications	783
System Settings	786
Changing the MEAP Applet Display Order	787
Checking Login Services	789

Setting Enhanced System Applications	791
Starting/Stopping Enhanced System Applications	792
Starting Enhanced System Applications	793
Stopping Enhanced System Applications	794
Installing Enhanced System Applications	795
Uninstalling Enhanced System Applications	798
Checking Information	800
Checking System Information	801
Checking Application Information	803
Checking License Files	804
Changing the SMS Password	805
Deleting the MEAP Application Setting Information	807
Managing MEAP Application Log Data	809
Downloading Log Data	810
Deleting Log Data	812
List of Error Messages (MEAP)	814
Errors Relating to the [Login] Page	815
Errors Relating to the [MEAP Application Management] Page	817
Errors Relating to the [Install MEAP Application] Page	819
Errors Relating to the [Authentication Information Settings] Page	824
Errors Relating to the [License Management] Page	825
Errors Relating to the [Enhanced System Application Management] Page	827
Errors Relating to the [Check License] and [Change Password] Pages	832
Errors Relating to the [MEAP Application Setting Information Management] Page	834
Errors Relating to the [MEAP Application Log Management] Page	835
Other Errors	836
Troubleshooting	837
Printing Cannot Be Performed	838
Printing Cannot Be Performed (USB Connection)	839
Printing Cannot Be Performed (LAN Connection)	843
Printing Cannot Be Performed (via the Print Server)	849
The Print Server for Connection Cannot Be Found	853
The Shared Printer Cannot Be Accessed	854
The Printer Takes a Long Time to Start the Print Job	855
You Cannot Turn the Printer ON	856
All the Indicators on the Network Interface Are Off	857
You Cannot Install the Printer Driver	858
The Printer Is Not Recognized Automatically	859
The Printer Cannot Be Searched for	860
You Cannot Uninstall the Printer Driver	861
The Printer Driver Settings Cannot Be Changed	862
"Profiles" Cannot Be Selected or Edited	864
The Status of the Paper Feeder Cannot Be Obtained Automatically	866
Paper Jams	868
Attention (Paper Jams)	869
Clearing Paper Jams (Multi-purpose Tray)	871
Clearing Paper Jams (Paper Drawer)	873
Clearing Paper Jams (Duplex Unit)	875
Clearing Paper Jams (Inside the Output Area)	878

Clearing Paper Jams (Inside the Front Cover)	880
The Message Indicator Is On	883
A Message Appears in the Control Panel	887
Poor Printout Results	903
Paper Curls	905
Paper Creases	906
White Streaks (Lines) Appear	907
Printing Is Uneven	908
Printed Pages Have White Specks	909
Toner Stain or Toner Peeling Occurs	910
The Printed Paper Has Smudge Marks	911
The Printed Paper Has Vertical Streaks	912
Smudge Marks of Spattering Toner Appear around the Text or Patterns	914
The Back of the Printed Paper Has Smudge Marks	915
The Overall Print Result Is Dark	916
Residual Images Appear on Non-printed Areas	917
White Dust Is Attached to the Printed Transparencies	918
The Overall Print Result Is Faint	919
The Printing Position Is Skewed	920
A Portion of the Page Is Not Printed	921
Data Is Reduced and Printed	922
The Next Page Is Printed from Halfway across the Previous Page	923
Printed Data Lies outside Paper	924
Blank Paper Is Output (Nothing Is Printed on the Paper)	925
The Overall Surface of the Paper Is Printed in Black Completely	926
The Last Page Cannot Be Printed	927
Unreadable Characters Are Printed	928
The Printout Is Different from What Is Displayed on Screen (Windows 2000, XP, and Server 2003)	929
The Flap of the Printed Envelope Sticks	930
Multiple Sheets of Paper Are Fed at a Time	931
Other Problems	932
The Keys on the Control Panel Do Not Function	933
The SD Card Cannot Be Used	934
Jobs Cannot Be Saved	935
SSL Cannot Be Enabled	936
When SSL Is Enabled, the Remote UI Does Not Start, or the IPP Printing Cannot Be Performed	937
The Printer Cannot Be Accessed from the Remote UI or Network Related Utility Software	938
Restricting the Users Is Not Possible	939
Noise Is Heard during Printing	940
If You Cannot Solve a Problem	941
Appendix	942
Basic Operations/Various Information for Windows	943
For Windows 8/Server 2012 Users	952
The Lists Common to All the Settings in the Print Mode	953
The Lists Common to Certain Settings in the Print Mode	955
Font Samples	957
Office Locations	963

[**↳ Legal Notices**](#)

[**↳ Legal Limitations on the Usage of Your Product and the Use of Images**](#)

[**↳ Using the e-Manual**](#)

Legal Notices

04L9-001

Product Name

Safety regulations require the product's name to be registered.
In some regions where this product is sold, the following name(s) in parentheses () may be registered instead.

LBP6680x (F161900)/LBP6670dn (F161900)

EMC requirements of EC Directive

This equipment conforms with the essential EMC requirements of EC Directive. We declare that this product conforms with the EMC requirements of EC Directive at nominal mains input 230 V, 50 Hz although the rated input of the product is 220 to 240 V, 50/60 Hz. Use of shielded cable is necessary to comply with the technical EMC requirements of EC Directive.

Laser Safety

This product is certified as a Class 1 laser product under IEC60825-1:2007 and EN60825-1:2007. This means that the product does not produce hazardous laser radiation.

Since radiation emitted inside the product is completely confined within protective housings and external covers, the laser beam cannot escape from the machine during any phase of user operation. Do not remove protective housings or external covers, except as directed by the equipment's manuals.

The label shown below is attached to the laser scanner unit inside the machine.



CLASS 1 LASER PRODUCT

LASER KLASSE 1

APPAREIL À LASER DE CLASSE 1

APPARECCHIO LASER DI CLASSE 1

PRODUCTO LÁSER DE CLASE 1

APARELHO A LASER DE CLASSE 1

LUOKAN 1 LASER-TUOTE

LASERPRODUKT KLASSE 1

CAUTION

Use of controls, adjustments, or performance of procedures other than those specified in this manual may result in hazardous radiation exposure.

International ENERGY STAR Program



As an ENERGY STAR® Partner, Canon Inc. has determined that this product meets the ENERGY STAR Program for energy efficiency.

The International ENERGY STAR Office Equipment Program is an international program that promotes energy saving through the use of computers and other office equipment.

The program backs the development and dissemination of products with functions that effectively reduce energy consumption. It is an open system in which business proprietors can participate voluntarily.

The targeted products are office equipment, such as computers, displays, printers, facsimiles, and copiers. The standards and logos are uniform among participating nations.

WEEE Directive



Only for European Union and EEA (Norway, Iceland and Liechtenstein)

These symbols indicate that this product is not to be disposed of with your household waste, according to the WEEE Directive (2012/19/EU), the Battery Directive (2006/66/EC) and/or national legislation implementing those Directives. If a chemical symbol is printed beneath the symbol shown above, in accordance with the Battery Directive, this indicates that a heavy metal (Hg = Mercury, Cd = Cadmium, Pb = Lead) is present in this battery or accumulator at a concentration above an applicable threshold specified in the Battery Directive.

This product should be handed over to a designated collection point, e.g., on an authorized one-for-one basis when you buy a new similar product or to an authorized collection site for recycling waste electrical and electronic equipment (EEE) and batteries and accumulators. Improper handling of this type of waste could have a possible impact on the environment and human health due to potentially hazardous substances that are generally associated with EEE. Your cooperation in the correct disposal of this product will contribute to the effective usage of natural resources.

For more information about the recycling of this product, please contact your local city office, waste authority, approved scheme or your household waste disposal service or visit www.canon-europe.com/weee, or www.canon-europe.com/battery.

License Notice

This product contains the Universal Font Scaling Technology or UFST® under license from Monotype Imaging, Inc.
UFST: Copyright © (2013) Monotype Imaging, Inc.

IPv6 Ready Logo



The protocol stack included in this machine has obtained the IPv6 Ready Logo Phase-1 established by the IPv6 Forum.

Legal Limitations on the Usage of Your Product and the Use of Images

04L9-002

Using your product to scan, print or otherwise reproduce certain documents, and the use of such images as scanned, printed or otherwise reproduced by your product, may be prohibited by law and may result in criminal and/or civil liability. A non-exhaustive list of these documents is set forth below. This list is intended to be a guide only. If you are uncertain about the legality of using your product to scan, print or otherwise reproduce any particular document, and/or of the use of the images scanned, printed or otherwise reproduced, you should consult in advance with your legal advisor for guidance.

- Paper Money
 - Travelers Checks
 - Money Orders
 - Food Stamps
 - Certificates of Deposit
 - Passports
 - Postage Stamps (canceled or uncanceled)
 - Immigration Papers
 - Identifying Badges or Insignias
 - Internal Revenue Stamps (canceled or uncanceled)
 - Selective Service or Draft Papers
 - Bonds or Other Certificates of Indebtedness
 - Checks or Drafts Issued by Governmental Agencies
 - Stock Certificates
 - Motor Vehicle Licenses and Certificates of Title
 - Copyrighted Works/Works of Art without Permission of Copyright Owner
-

Even if you do not have the supplied CD-ROM at hand, you can view the e-Manual any time if you install it on your computer beforehand.

For the efficient use of the e-Manual, you can use several search tools to find the desired content.

▸ How to Use the e-Manual

- [Operating Environment](#)
- [Installing the e-Manual](#)
- [Uninstalling the e-Manual](#)

▸ Screen Layout of the e-Manual

- [Top Page](#)
- [Topic Page](#)
- [Contents Page](#)
- [Search Method](#)

▸ Viewing the e-Manual

<To find the desired content>

- **Selecting between the category icons**

From the top page, select a category icon you want.

▸ ["Top Page"](#)

- **Searching from the list of contents**

On the list of contents, you can view the list of whole sections of the e-Manual sorted by category. You can directly display sections in a category.

▸ ["Contents Page"](#)

- **Whole text search function**

You can search by keyword in the e-Manual. You can display the desired description from the search results by entering a keyword you want to search. This function supports AND search.

▸ ["Search Method"](#)

How to Use the e-Manual

04L9-004

Click the following links to see the system requirements to use the e-Manual and how to install/uninstall the e-Manual.

[➤ Operating Environment](#)

[➤ Installing the e-Manual](#)

[➤ Uninstalling the e-Manual](#)

Operating Environment

04L9-005

You need a Web browser to use the e-Manual. Operation of the following Web browsers is guaranteed.

Windows

- Internet Explorer 6.0/7.0/8.0/9.0
- Firefox 2.x/3.x/4.x/5.x/6.x/7.x/8.x

Macintosh

- Safari 2.x/3.x/4.x/5.0/5.1
- Firefox 2.x/3.x/4.x/5.x/6.x/7.x/8.x

NOTE

Enabling the script function

Enable the script function for a Web browser before using the e-Manual.

Installing the e-Manual

04L9-006

Install the e-Manual included in the supplied User Manual CD-ROM on your computer using the following procedure.

For Windows

1

Insert the supplied User Manual CD-ROM in the CD-ROM drive of your computer.

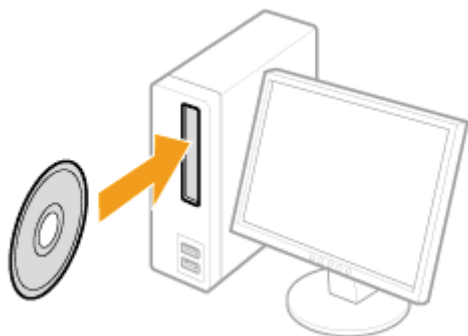

2

Perform the following procedure.

- (1) Select your language.
- (2) Click [Install].

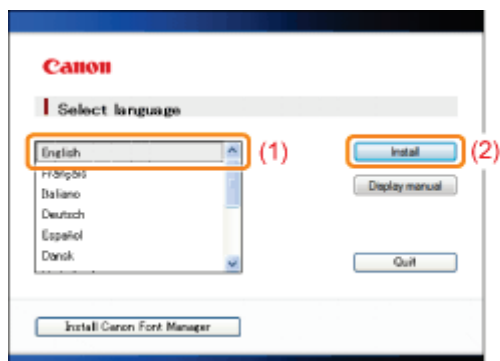

? If the above screen does not appear

- "Basic Operations/Various Information for Windows"

? If the [AutoPlay] dialog box appears

- Click [Run Maninst.exe].

? If the [User Account Control] dialog box appears

- Click [Yes] or [Continue].

→ The installation starts.

Wait until the following screen disappears. (It may take a long time to install the e-Manual.)

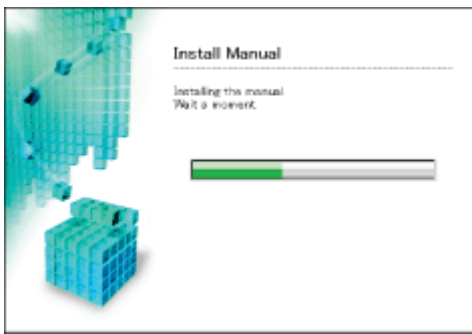

Displaying the e-Manual

Double-click [LBP6670_LBP6680 e-Manual] created on the desktop.

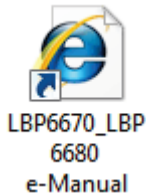

When a security protection message appears

To help protect your security, Internet Explorer has restricted this webpage from running scripts or ActiveX controls that could access your computer. Click here for options...

Perform the following procedure.

1. Click the information bar, and then select [Allow Blocked Content] from the pop-up menu.



2. Click [Yes].

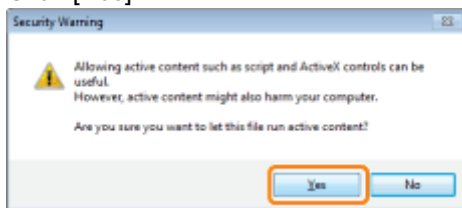

NOTE

Displaying the e-Manual directly from the CD-ROM

You can also display the e-Manual directly from the CD-ROM without installing it in the computer you are using.

1. Insert the supplied User Manual CD-ROM in the CD-ROM drive of your computer.
2. Select your language.
3. Click [Display manual].

† Depending on the operating system you are using, a security protection message is displayed. Allow the contents to be displayed.

For Macintosh

1

Insert the supplied User Manual CD-ROM in the CD-ROM drive of your computer.

2

Drag and drop the [uk_LBP6670_LBP6680_Manual] folder into a location where you want to save it.

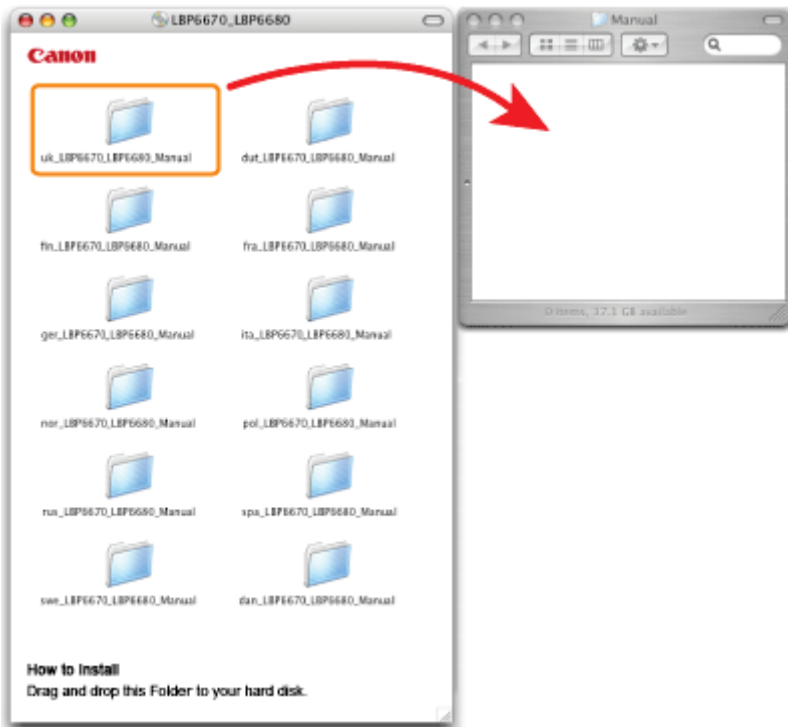

NOTE

Displaying the e-Manual directly from the CD-ROM

You can also display the e-Manual directly from the CD-ROM without installing it in the computer you are using.

1. Insert the supplied User Manual CD-ROM in the CD-ROM drive of your computer.
2. Double-click the [uk_LBP6670_LBP6680_Manual] folder.



uk_LBP6670_LBP6680_Manual

3. Double-click [index.html].



index.html

Uninstalling the e-Manual

04L9-007

The process of removing the e-Manual to restore the computer to the same state as before the e-Manual was installed is referred to as uninstallation. To uninstall the e-Manual, perform the following procedure.

For Windows

Delete the files in the following locations manually.

- Manual folder

Windows 2000 **Windows XP** **Windows Server 2003**

The "uk_LBP6670_LBP6680_Manual" folder in "C:\Documents and Settings\user name)\My Documents\Canon\LBP\Manuals"

Windows Vista **Windows 7** **Windows Server 2008**

The "uk_LBP6670_LBP6680_Manual" folder in "C:\Users\user name)\Documents\Canon\LBP\Manuals"

- The "LBP6670_LBP6680 e-Manual" shortcut icon on the desktop

For Macintosh

Delete the [uk_LBP6670_LBP6680_Manual] folder manually which is copied during the installation.

Screen Layout of the e-Manual

04L9-008

This section describes the screen layout of the e-Manual.

The page displayed right after the e-Manual starts is called "Top Page" and the manual description is called "Topic Page" in this section.

The "Contents Page" is displayed from [Contents] which is located on the upper right of the e-Manual and the search dialog box is displayed from each page in another window.

The screen layout is different for each page, so click the following links to see the instruction.

[**➤ Top Page**](#)

[**➤ Topic Page**](#)

[**➤ Contents Page**](#)

[**➤ Search Method**](#)

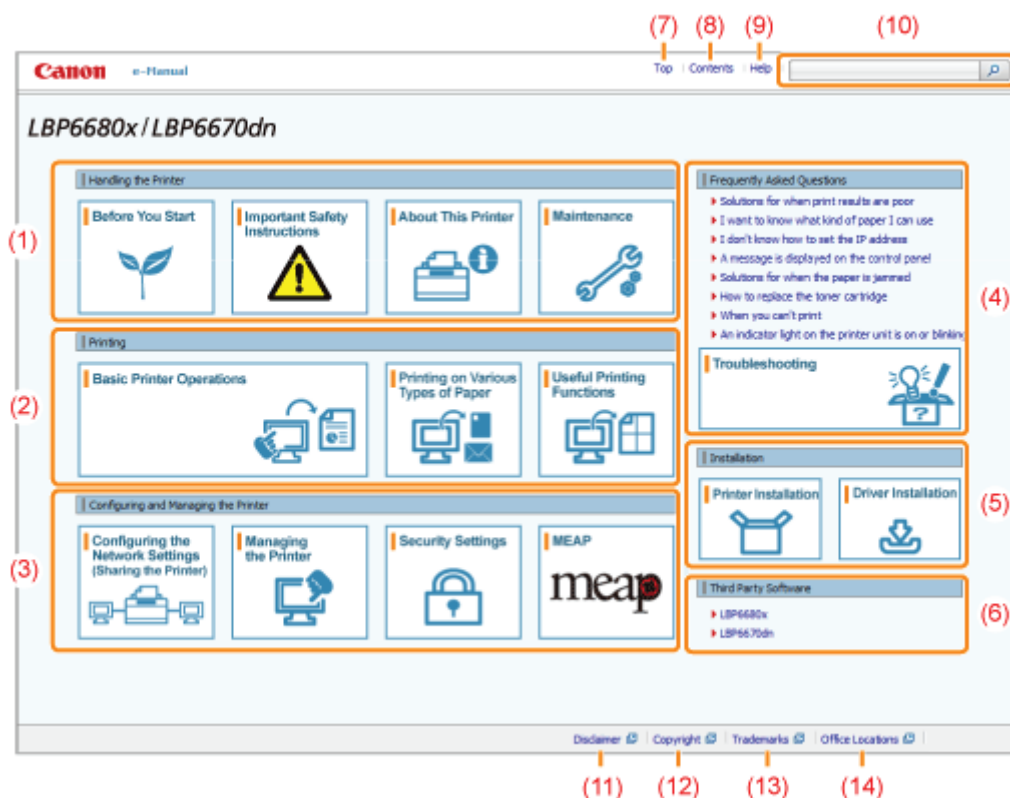

(1) Handling the Printer

This section describes the precautions and maintenance methods for handling the printer, and so on.

(2) Printing

This section describes a variety of printing methods, such as basic printing and advanced one that uses the various printing functions.

How to load paper is also described here.

(3) Configuring and Managing the Printer

This section describes how to specify the network settings, how to manage the printer, and so on.

(4) Frequently Asked Questions

Frequently asked questions are featured.

For details on the solutions for the other problems, see [Troubleshooting].

(5) Installation

This section described how to install this printer, how to install the printer driver, and so on.

(6) Third Party Software

The information about the third party software is displayed.

(7) [Top]

The top page of the e-Manual is displayed.

(8) [Contents]

The entire contents of the e-Manual are displayed.

(9) [Help]

How to use the e-Manual is displayed.

(10) [Enter keyword(s) here]

The search dialog box is displayed by entering a keyword and clicking [].

For details, see "Search Method."

(11) [Disclaimer]

The disclaimers are displayed.

(12) [Copyright]

The information of copyrights is displayed.

(13) [Trademarks]

The trademarks are displayed.

(14) [Office Locations]

Inquiries for this printer are displayed.

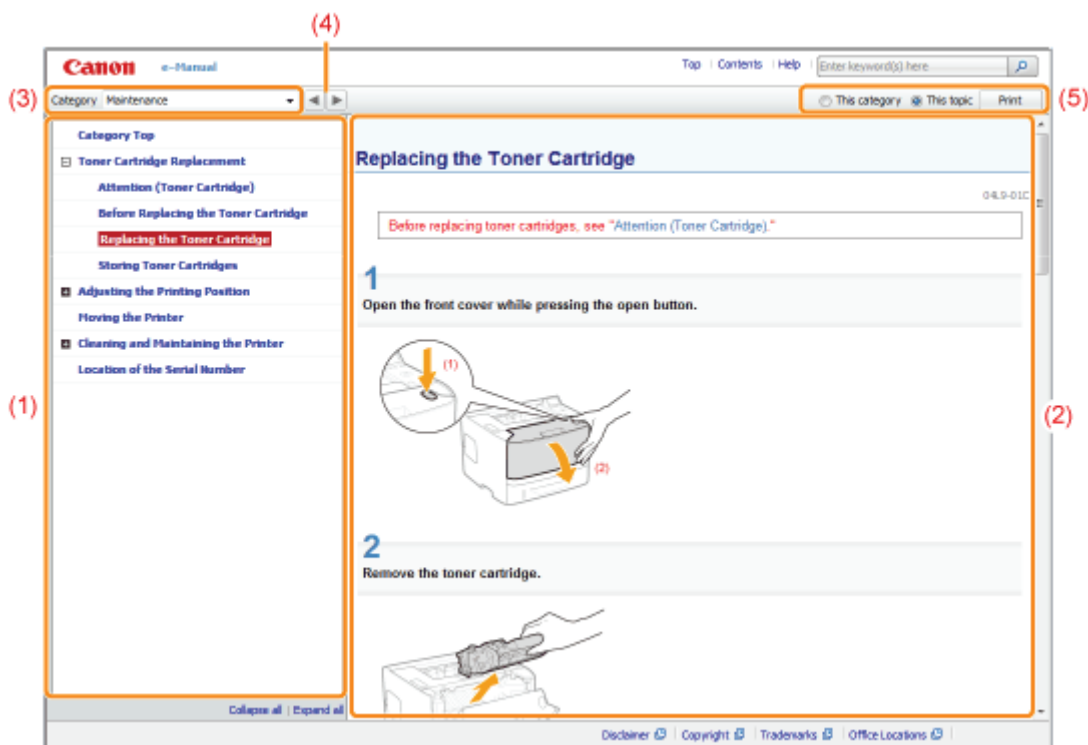

(1) Category contents

This is the list of the contents in the category. Clicking each item displays the description in the topic page. Clicking [+] opens the menu and clicking [-] closes the menu.

(2) Topic page

The descriptions of each item are displayed.

(3) [Category] menu

You can select a different category from the pull-down menu.

(4) [< >]

Click to move to the previous or next category.

(5) [Print]

Prints the e-Manual.

Select either of the following when printing.

[This category]	Prints all the contents in a category.
[This topic]	Prints only the topic page currently displayed.

Contents Page

04L9-00C

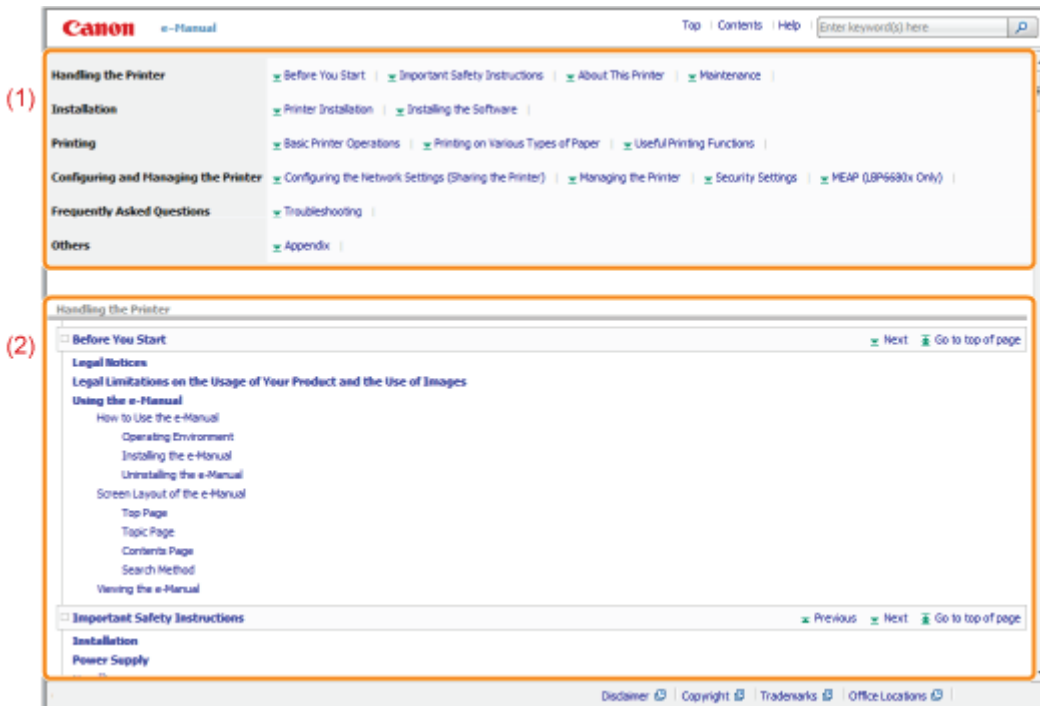

(1) Categories

Shows the categories of the e-Manual. Click a category to view the detailed list of the category.

(2) Whole contents

Shows the all categories and sections of the e-Manual. Click an item to view the contents.

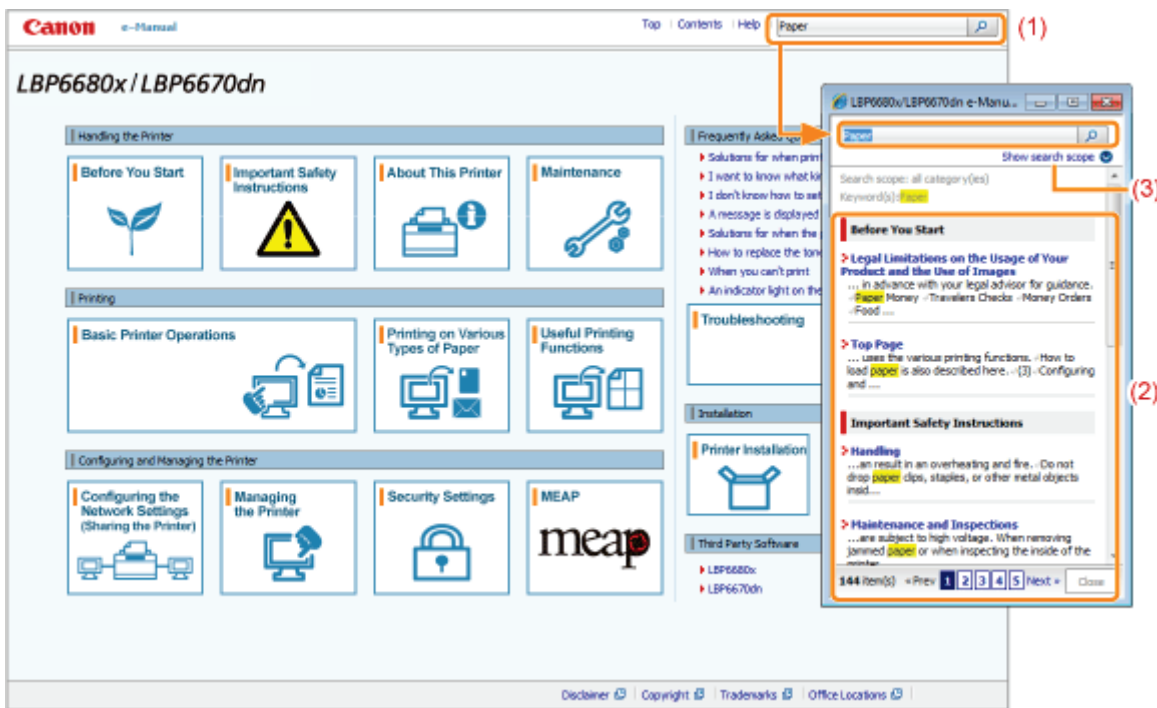

(1) [Enter keyword(s) here]

Enter a keyword in the entry field which is located on the upper right of the "Top page" or "Topic page", and then click []. The search dialog box is displayed.

You can also search by entering a keyword in the displayed dialog box.

Also, the AND search is available in the e-Manual so you can refine the search results by entering two or more keywords. When entering keywords, enter a space between the keywords.

- **Example:** "Toner Replacement" (if you want to display pages which include words, "Toner" and "Replacement")

(2) Search result

The search results for a keyword are displayed.

If the search results are more than 10 results, you can see the other results by clicking [<< Prev], [Next >>], or the number which is located below the result.

(3) [Show search scope]

If you want to specify a search scope, click here, and then select the check box for the category which you want to search.

Viewing the e-Manual

04L9-00F

Symbols Used in the e-Manual

The following are descriptions of warnings and cautions used in the e-Manual to explain handling restrictions, precautions, and instructions that should be observed for your safety.

WARNING

Indicates a warning concerning operations that may lead to death or injury to persons if not performed correctly. To use the machine safely, always pay attention to these warnings.

CAUTION

Indicates a caution concerning operations that may lead to injury to persons if not performed correctly. To use the machine safely, always pay attention to these cautions.

IMPORTANT

Indicates operational requirements and restrictions. Be sure to read these items carefully to operate the machine correctly, and avoid damage to the machine or property.

NOTE



Indicates a clarification of an operation, or contains additional explanations for a procedure. Reading these notes is highly recommended.



Indicates an operation that must not be performed. Read these items carefully, and make sure not to perform the described operations.

Keys and Buttons Used in This Manual

The following are examples of how control panel keys and on-screen buttons are depicted in the e-Manual.

Type	Depiction in the e-Manual	Example
Control panel keys	[Key icon] + (Key name)	[] ( /  : Job Status/Cancel)
Buttons on computer operation screen and so on	[Button name and so on]	[OK]

Screenshots Used in the e-Manual

The contents of the screenshots used in the e-Manual are the default settings.

Depending on the system configuration, the contents of the screenshots may partly differ.

† The functions of the printer driver may be changed due to upgrade.

Illustrations Used in the e-Manual

- The illustrations of the toner cartridge used in the e-Manual are those for Canon Cartridge 719.

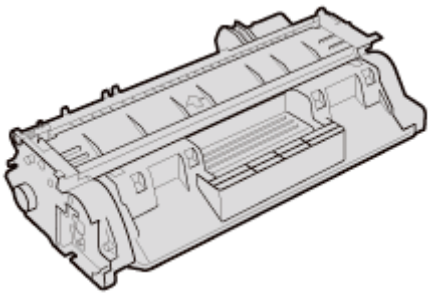

- Although the power cord used in this manual is as the one in the following illustration, the form of the power cord may differ depending on the country or region.

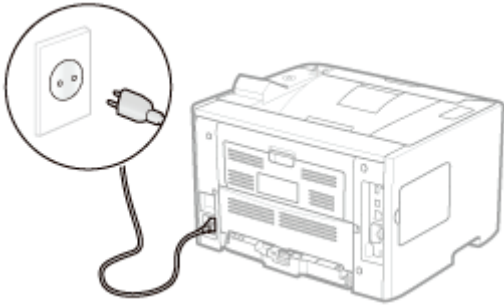

Abbreviations Used in the e-Manual

Abbreviations of Operating Systems

In the e-Manual, operating systems are abbreviated as follows.

Microsoft Windows 2000 operating system	Windows 2000
Microsoft Windows XP operating system	Windows XP
Microsoft Windows Vista operating system	Windows Vista
Microsoft Windows 7 operating system	Windows 7
Microsoft Windows Server 2003 operating system	Windows Server 2003
Microsoft Windows Server 2008 operating system	Windows Server 2008
Microsoft Windows operating system	Windows

Disclaimer

04L9-00H

The information in this manual is subject to change without notice.

CANON INC. MAKES NO WARRANTY OF ANY KIND WITH REGARD TO THIS MATERIAL, EITHER EXPRESS OR IMPLIED, EXCEPT AS PROVIDED HEREIN, INCLUDING WITHOUT LIMITATION, THEREOF, WARRANTIES AS TO MARKETABILITY, MERCHANTABILITY, FITNESS FOR A PARTICULAR PURPOSE OF USE OR AGAINST INFRINGEMENT OF ANY PATENT. CANON INC. SHALL NOT BE LIABLE FOR ANY DIRECT, INCIDENTAL, OR CONSEQUENTIAL DAMAGES OF ANY NATURE, OR LOSSES OR EXPENSES RESULTING FROM THE USE OF THIS MATERIAL.

Copyright

04L9-00J

Copyright CANON INC. 2013

No part of this publication may be reproduced or transmitted in any form or by any means, electronic or mechanical, including photocopying and recording, or by any information storage or retrieval system without the prior written permission of Canon Inc.

Trademarks

04L9-00K

- "MEAP" is a trademark of CANON Inc., referring to an "application platform" for Canon multifunction and single function printers.
- Adobe, Adobe Acrobat, and Adobe Reader are trademarks of Adobe Systems Incorporated.
- Apple, AppleTalk, Mac, Mac OS, Macintosh, and TrueType are trademarks of Apple Inc., registered in the U.S. and other countries.
- EtherTalk and LocalTalk are trademarks of Apple Inc.
- Microsoft, Windows, Windows Vista, Windows Server and Internet Explorer are either registered trademarks or trademarks of Microsoft Corporation in the United States and/or other countries.
- Ethernet is a trademark of Xerox Corporation.
- This product contains the Universal Font Scaling Technology or UFST[®] under license from Monotype Imaging, Inc. UFST[®] is a trademark of Monotype Imaging, Inc. registered in the United States Patent and Trademark Office and may be registered in certain jurisdictions.
- UFST: Copyright[©] 1989 - 1996, 1997, 2003, 2004, 2008, all rights reserved, by Monotype Imaging Inc.
- Copyright[©] Unpublished Work of Novell, Inc. All Rights Reserved.



- Java and all Java based trademarks and logos are trademarks or registered trademarks of Oracle and/or its affiliates.



- Adobe, PostScript, and the PostScript logo are either registered trademarks or trademarks of Adobe Systems Incorporated in the United States and/or other countries.
- Copyright[©] 2007 -08 Adobe Systems Incorporated. All rights reserved.
- Protected by U.S. Patents 5,737,599; 5,781,785; 5,819,301; 5,929,866; 5,943,063; 6,073,148; 6,515,763; 6,639,593; 6,754,382; 7,046,403; 7,213,269; 7,242,415; Patents pending in the U.S. and other countries.
- All instances of the name PostScript in the text are references to the PostScript language as defined by Adobe Systems Incorporated unless otherwise stated. The name PostScript also is used as a product trademark for Adobe Systems' implementation of the PostScript language interpreter.
- Except as otherwise stated, any reference to a "PostScript printing device," "PostScript display device," or similar item refers to a printing device, display device or item (respectively) that contains PostScript technology created or licensed by Adobe Systems Incorporated and not to devices or items that purport to be merely compatible with the PostScript language.
- Adobe, the Adobe logo, PostScript, the PostScript logo, and PostScript 3 are either registered trademarks or trademarks of Adobe Systems Incorporated in the United States and/or other countries.
- Linux is a registered trademark of Linus Torvalds. Microsoft and Windows are either registered trademarks or trademarks of Microsoft Corporation in the United States and/or other countries.
- All other trademarks are the property of their respective owners.
- Other product and company names herein may be the trademarks of their respective owners.

Important Safety Instructions

04L9-00R

Read these "Important Safety Instructions" thoroughly before operating the printer.

As these instructions are intended to prevent injury to the user and other persons or destruction of property, always pay attention to these instructions.

Also, as it may result in unexpected accidents or injuries, do not perform any operation unless otherwise specified in the manual. Improper operation or use of this machine could result in personal injury and/or damage requiring extensive repair that may not be covered under your Limited Warranty.

▸ Installation

▸ Power Supply

▸ Handling

▸ Maintenance and Inspections

▸ Consumables

▸ Others

WARNING

- Do not install the printer in a location near alcohol, paint thinner, or other flammable substances. If flammable substances come into contact with electrical parts inside the printer, this may result in a fire or electrical shock.
- Do not place the following items on the printer.
 - Necklaces and other metal objects
 - Cups, vases, flowerpots, and other containers filled with water or liquids

If these items come into contact with a high-voltage area inside the printer, this may result in a fire or electrical shock. If these items are dropped or spilled inside the printer, immediately turn OFF the power switch (1) and disconnect the interface cables if they are connected (2). Then, unplug the power plug from the AC power outlet (3) and contact your local authorized Canon dealer.

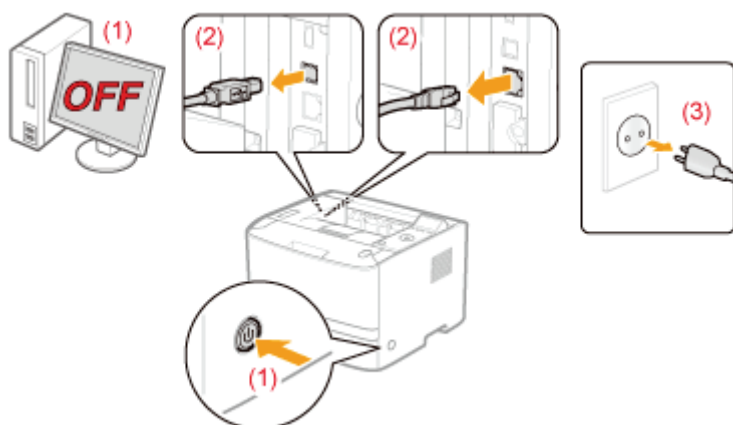

- When installing or removing the optional accessories, be sure to turn the printer OFF, unplug the power plug, and then disconnect all the interface cables and power cord from the printer. Otherwise, the power cord or interface cables may be damaged, resulting in a fire or electrical shock.

CAUTION

- Do not install the printer in unstable locations, such as on unsteady platforms or inclined floors, or in locations subject to excessive vibrations, as this may cause the printer to fall or tip over, resulting in personal injury.
- The ventilation slots are provided for proper ventilation of working parts inside the printer. Never place the printer on a soft surface, such as a bed, sofa, or rug. Blocking the slots can cause the printer to overheat, resulting in a fire.
- Do not install the printer in the following locations, as this may result in a fire or electrical shock.
 - A damp or dusty location
 - A location exposed to smoke and steam, such as near a cookery or humidifier
 - A location exposed to rain or snow
 - A location near a water faucet or water
 - A location exposed to direct sunlight
 - A location subject to high temperatures
 - A location near open flames
- When installing the printer, gently lower the printer to the installation site so as not to catch your hands between the printer and the floor or between the printer and other equipment, as this may result in personal injury.
- When connecting the interface cable, connect it properly by following the instructions in the e-Manual. If not connected properly, this may result in malfunction or electrical shock.
- Be careful when handling the main board or the ROM. Touching the main board or the sharp parts such as the edges of the ROM may result in personal injury.
- When moving the printer, follow the instructions in the e-Manual to hold it correctly. Failure to do so may cause you to drop the printer, resulting in personal injury.
 - ["Moving the Printer"](#)

At high altitudes of about 3,000 meters above sea level, or higher

Machines with a hard disk may not operate properly when used at high altitudes of about 3,000 meters above sea level, or higher.

WARNING

- Do not damage or modify the power cord. Also, do not place heavy objects on the power cord or pull on or excessively bend it, as this can cause electrical damage, resulting in fire or electrical shock.
- Keep the power cord away from all heat sources. Failure to do so can cause the power cord insulation to melt, resulting in a fire or electrical shock.
- The power cord should not be taut, as this may lead to a loose connection and cause overheating, which could result in a fire.
- The power cord may become damaged if it is stepped on, fixed with staples, or if heavy objects are placed on it. Continued use of a damaged power cord can lead to an accident, such as a fire or electrical shock.
- Do not plug or unplug the power plug with wet hands, as this can result in electrical shock.
- Do not plug the power cord into a multi-plug power strip, as this can result in a fire or electrical shock.
- Do not bundle up or tie up the power cord in a knot, as this can result in a fire or electrical shock.
- Insert the power plug completely in the AC power outlet. Failure to do so can result in a fire or electrical shock.
- If excessive stress is applied to the connection part of the power cord, it may damage the power cord or the wires inside the machine may disconnect. This could result in a fire. Avoid the following situations:
 - Connecting and disconnecting the power cord frequently.
 - Tripping over the power cord.
 - The power cord is bent near the connection part, and continuous stress is being applied to the power outlet or the connection part.
 - Applying a shock to the power connector.
- Do not use power cords other than the one provided, as this can result in a fire or electrical shock.
- As a general rule, do not use extension cords. Using an extension cord may result in a fire or electrical shock.

CAUTION

- Do not use a power supply voltage other than that listed herein, as this may result in a fire or electrical shock.
- Always grasp the power plug when unplugging the power plug. Do not pull on the power cord, as this may expose the core wire of the power cord or damage the cord insulation, causing electricity to leak, resulting in a fire or electrical shock.
- Leave sufficient space around the power plug so that it can be unplugged easily. If objects are placed around the power plug, you may be unable to unplug it in an emergency.

WARNING

- Do not disassemble or modify the printer. There are high-temperature and high-voltage components inside the printer which may result in a fire or electrical shock.
- Electrical equipment can be hazardous if not used properly. Do not allow children to touch the power cord, cables, internal gears, or electrical parts.
- If the printer makes an unusual noise or emits smoke, heat, or an unusual smell, immediately turn OFF the power switch and disconnect the interface cables if they are connected. Then, unplug the power plug from the AC power outlet and contact your local authorized Canon dealer. Continued use can result in a fire or electrical shock.
- Do not use flammable sprays near the printer. If flammable substances come into contact with electrical parts inside the printer, this may result in a fire or electrical shock.
- Always turn OFF the power switch and unplug the power plug and interface cables before moving the printer. Failure to do so can damage the cables or cords, resulting in a fire or electrical shock.
- Confirm that the power plug or power connector is inserted completely after moving the printer. Failure to do so can result in an overheating and fire.
- Do not drop paper clips, staples, or other metal objects inside the printer. Also, do not spill water, liquids, or other flammable substances (alcohol, benzene, paint thinner, and so on) inside the printer. If these items come into contact with a high-voltage area inside the printer, this may result in a fire or electrical shock. If these items are dropped or spilled inside the printer, immediately turn OFF the power switch and disconnect the interface cables if they are connected. Then, unplug the power plug from the AC power outlet and contact your local authorized Canon dealer.
- When plugging or unplugging a USB cable when the power plug is plugged into an AC power outlet, do not touch the metal part of the connector, as this can result in electrical shock.

CAUTION

- Do not place heavy objects on the printer. The object or the printer may fall, resulting in personal injury.
- Be careful when handling the main board or the ROM. Touching the main board or the sharp parts such as the edges of the ROM may result in personal injury.
- Turn OFF the power switch when the printer will not be used for a long period of time, such as overnight. Turn OFF the printer and unplug the power plug if the printer will not be used for an extended period of time, such as for several days.
- Open or close covers and install or remove drawers gently and carefully. Be careful not to hurt your fingers.
- Keep your hands and clothing away from the roller in the output area. Even if the printer is not printing, the roller may suddenly rotate and catch your hands or clothing, resulting in personal injury.
- Do not take your hands off the transport guide until it moves back to its original position when tilting the transport guide toward you. The transport guide may snap back to its original position, and this may result in personal injury.
- The output slot is hot during and immediately after printing. Do not touch the area surrounding the output slot, as this may result in burns.



- Printed paper may be hot immediately after being output. Be careful when removing the paper and aligning the removed paper, especially after continuous printing. Failure to do so may result in burns.
- The laser beam used in the printer can be harmful to human bodies. The laser beam is confined in the laser scanner unit by a cover, so there is no danger of the laser beam escaping during normal printer operation. Read the

following remarks and instructions for safety.

- Never open covers other than those indicated in this manual.
- Do not remove the caution label attached to the cover of the laser scanner unit.



- If the laser beam should escape and enter your eyes, exposure may cause damage to your eyes.

WARNING

- When cleaning the printer, turn OFF the printer and computer, remove the interface cables, and then unplug the power plug. Failure to do so can result in a fire or electrical shock.
- Unplug the power plug from the AC power outlet periodically and clean the area around the base of the power plug's metal pins and the AC power outlet with a dry cloth to remove all dust and grime. In damp, dusty, or smoky locations, dust can build up around the power plug and become damp, which can cause a short circuit, resulting in a fire.
- Clean the printer with a well wrung out cloth dampened with water or mild detergent diluted with water. Do not use alcohol, benzene, paint thinner, or other flammable substances. If flammable substances come into contact with electrical parts inside the printer, this may result in a fire or electrical shock.
- Some areas inside the printer are subject to high voltage. When removing jammed paper or when inspecting the inside of the printer, be careful not to allow necklaces, bracelets, or other metal objects to touch the inside of the printer, as this can result in burns or electrical shock.
- Do not dispose of used toner cartridges in open flames. This may cause the toner remaining inside the cartridges to ignite, resulting in burns or fire.
- If you accidentally spill or scatter toner, carefully gather the toner particles together or wipe them up with a soft, damp cloth in a way that prevents inhalation.
Never use a vacuum cleaner that does not have safeguards against dust explosions to clean up spilled toner. Doing so may cause a malfunction in the vacuum cleaner, or result in a dust explosion due to static discharge.
- Confirm that the power plug or power connector is inserted completely after cleaning the printer. Failure to do so can result in an overheating and fire.
- Check the power cord and plug regularly. The following conditions may result in fire, so contact your local authorized Canon dealer or the Canon help line.
 - There are burn marks on the power plug.
 - The blade on the power plug is deformed or broken.
 - The power is turned OFF or ON when bending the power cord.
 - The coating of the power cord is damaged, cracked, or dented.
 - A part of the power cord becomes hot.
- Check regularly that the power cord, plug, and connector are not handled in the following manner. This may result in a fire or electrical shock.
 - The power connector is loosened.
 - The power plug is loosened.
 - Stress is being applied to the power cord by a heavy object or by fixing it with staples.
 - The power cord is tied in a bundle.
 - A part of the power cord is put in an aisle.
 - The power cord is put in front of the heating appliance.

CAUTION

- Never attempt to service this printer yourself, except as explained in this manual. There are no user serviceable parts inside the printer. Adjust only those controls that are covered in the operating instructions. Improper adjustment could result in personal injury and/or damage requiring extensive repair that may not be covered under your Limited Warranty.
- The fixing unit and its surroundings inside the printer become hot during use. When removing jammed paper or when inspecting the inside of the printer, do not touch the fixing unit and its surroundings, as this may result in burns.
- When removing jammed paper or when inspecting the inside of the machine, do not expose yourself to the heat emitted from the fixing unit and its surroundings for a prolonged period of time. Doing so may result in low temperature burns, even though you did not touch the fixing unit and its surroundings directly, as this may result in burns.
- If paper is jammed, remove the jammed paper so that any pieces of paper do not remain inside the printer according to the displayed message. Also, do not put your hands forcibly in the parts other than those directed on the screen. Failure to do so may result in burns or injuries.
- When removing jammed paper or replacing a toner cartridge, be careful not to get any toner on your hands or

clothing, as this will dirty your hands or clothing. If toner gets on your hands or clothing, wash them immediately with cold water. Washing with warm water sets the toner, making it impossible to remove the toner stains.

- When removing jammed paper, be careful not to allow the toner on the paper to scatter. The toner may get into your eyes or mouth. If toner gets into your eyes or mouth, wash them immediately with cold water and consult a physician.
- When loading paper or removing jammed paper, be careful not to cut your hands with the edges of the paper.
- When removing a toner cartridge, remove the toner cartridge carefully so as to prevent the toner from scattering and getting into your eyes or mouth. If toner gets into your eyes or mouth, wash them immediately with cold water and consult a physician.
- Do not attempt to disassemble the toner cartridge. The toner may scatter and get into your eyes or mouth. If toner gets into your eyes or mouth, wash them immediately with cold water and consult a physician.
- If toner leaks from the toner cartridge, be careful not to inhale the toner or allow it to come into direct contact with your skin. If the toner comes into contact with your skin, wash with soap. If the skin becomes irritated or you inhale the toner, consult a physician immediately.

WARNING

- Do not dispose of used toner cartridges in open flames. This may cause the toner to ignite, resulting in burns or fire.
- Do not store toner cartridges or paper in a location exposed to open flames. This may cause the toner or paper to ignite, resulting in burns or fire.
- When disposing of a toner cartridge, place the toner cartridge into a bag to prevent the toner from scattering, and then dispose of the toner cartridge according to local regulations.
- If you accidentally spill or scatter toner, carefully gather the toner particles together or wipe them up with a soft, damp cloth in a way that prevents inhalation.
Never use a vacuum cleaner that does not have safeguards against dust explosions to clean up spilled toner. Doing so may cause a malfunction in the vacuum cleaner, or result in a dust explosion due to static discharge.

CAUTION

- Keep the toner cartridges and other consumables out of the reach of small children. If the toner or other parts are ingested, consult a physician immediately.
- Do not attempt to disassemble the toner cartridge. The toner may scatter and get into your eyes or mouth. If toner gets into your eyes or mouth, wash them immediately with cold water and consult a physician.
- If toner leaks from the toner cartridge, be careful not to inhale the toner or allow it to come into direct contact with your skin. If the toner comes into contact with your skin, wash with soap. If the skin becomes irritated or you inhale the toner, consult a physician immediately.
- If the sealing tape is pulled out forcefully or stopped at midpoint, toner may spill out. If the toner gets into your eyes or mouth, wash them immediately with cold water and immediately consult a physician.

 **WARNING**

The printer generates a low-level magnetic field. If you use a cardiac pacemaker and feel abnormalities, move away from the printer and consult your physician immediately.

About This Printer

04L9-010

➤ **Printer Specifications**

➤ **Introduction of the Optional Accessories**

➤ **Names and Dimensions of Each Part**

➤ **Control Panel**

➤ **Introduction of the Utilities**

➤ **Energy-saving Mode**

➤ **Cautions for Handling the Printer**

➤ **Consumables**

Printer Specifications

04L9-011

Hardware Specifications

Type	Desktop Page Printer
Printing System	Semiconductor laser + xerographic system
Toner fixing system	On-demand fixing system
Resolution	600 dpi
Printing speed (Plain paper (60 to 90 g/m ²), when printing A4 size paper continuously)	<ul style="list-style-type: none"> • 33 pages/min. (1-sided printing) • 16.8 pages/min. / 8.4 sheets/min. (2-sided printing) <p>† The print speed may drop depending on the output resolution setting and the paper settings for the size, type, orientation, and number of copies.</p>
Warm up time (Time from power on to printer ready)	<p>28 seconds or less</p> <p>† May vary depending on the usage conditions, such as the availability of the optional accessories and installation environment.</p>
Recovery time (Time from the sleep mode to printer ready)	<ul style="list-style-type: none"> • 10 seconds or less when the printer is in Sleep Mode 1 (the Deep Sleep mode)* <p>* It is the default setting. For details on [Sleep Mode], see "Sleep Mode."</p> <p>† May vary depending on the output environment.</p>
First print time (When performing 1-sided printing on A4 size paper and outputting face-down)	<p>7 seconds</p> <p>† May vary depending on the output environment.</p>
Paper size	<ul style="list-style-type: none"> • Drawer 1/Drawer 2 (Optional) <ul style="list-style-type: none"> – Standard sizes: A4, B5, A5, A6, Legal, Letter, Executive and 16K – Custom paper sizes *1: Width 105.0 to 215.9 mm, Length 148.0 to 355.6 mm <p>† If you are using the UFR II printer driver, you can load custom size paper that is 148.0 to 215.9 mm wide and 148.0 to 215.9 mm long in landscape orientation.</p> <ul style="list-style-type: none"> • Multi-purpose tray <ul style="list-style-type: none"> – Standard sizes: A4, B5, A5, A6, Legal, Letter, Executive, Statement, 16K, Index Card, Envelope DL, Envelope No.10, Envelope ISO-C5, Envelope ISO-B5, and Envelope Monarch – Custom paper sizes *1: Width 76.2 to 215.9 mm, Length 127.0 to 355.6 mm <p>† If you are using the UFR II printer driver, you can load custom size paper that is 127.0 to 215.9 mm wide and 127.0 to 215.9 mm long in landscape orientation.</p> <p>*1 Width must not be greater than length (height).</p>
	<ul style="list-style-type: none"> •

Paper capacity	<ul style="list-style-type: none"> Drawer 1: Approx. 250 sheets Drawer 2 (Optional): Approx. 500 sheets Multi-purpose tray: Approx. 50 sheets
2-sided printing	A4, Legal, Letter
Paper output	Face-down/Face-up
Output capacity	<p>Output tray: Approx. 150 sheets</p> <p>Sub-output tray: 1 sheet</p>
Noise (measured in accordance with ISO 7779, declared noise emission in accordance with ISO 9296)	<ul style="list-style-type: none"> LwAd (declared A-weighted sound power level (1 B = 10 dB)) <ul style="list-style-type: none"> - During standby: Inaudible * - During operation: 7.06 B or less LpAm (declared A-weighted sound pressure level (bystander position)) <ul style="list-style-type: none"> - During standby: Inaudible * - During operation: 54.2 dB <p>* Indicates the sound pressure level of each bystander position is below the ISO 7779 absolute criteria for the background noise level.</p>
Operating environment (Printer unit only)	<ul style="list-style-type: none"> Operating environment <ul style="list-style-type: none"> - Temperature range: 10 to 30°C (50 to 86°F) - Humidity range: 20 to 80% RH (no condensation)
Power supply	220 to 240 V (±10%), 50/60 Hz (±2 Hz)
Power consumption (at 20°C (68°F))	<ul style="list-style-type: none"> Maximum: 1,140 W or less Average during operation: Approx. 560 W Average during standby: Approx. 14 W Average during Deep Sleep Mode (Sleep Mode 1): Approx. 1 W* When the main power switch is turned OFF: 0.02 W or less <p>* It is the default setting. For details on [Sleep Mode], see "Sleep Mode."</p> <p>† Even if the printer is turned OFF, power is still consumed slightly while the power plug is inserted in the AC power outlet. To stop the power consumption completely, unplug the power plug from the AC power outlet.</p>
Consumables	<ul style="list-style-type: none"> Canon Cartridge 719 Canon Cartridge 719 H <p>† For details on the yield, see "Replacement Timing" in "Consumables."</p>
Weight	<ul style="list-style-type: none"> Printer unit and included parts <ul style="list-style-type: none"> - Printer unit (excluding the toner cartridges and drum cartridge): Approx. 11.6 kg - Toner cartridge: Approx. 0.8 kg Consumables and optional accessories <ul style="list-style-type: none"> - Toner cartridge (Canon Cartridge 719): Approx. 0.8 kg - Toner cartridge (Canon Cartridge 719 H): Approx. 1.0 kg - Paper Feeder Unit PF-44 (including the paper drawer): Approx. 4.1 kg

Controller Specifications

CPU	528 MHz + 264 MHz
Memory (RAM) capacity	<ul style="list-style-type: none"> LBP6680x <ul style="list-style-type: none"> - 768 MB LBP6670dn <ul style="list-style-type: none"> -

	- 512 MB
Host interface	<ul style="list-style-type: none"> • LBP6680x <ul style="list-style-type: none"> - USB interface: <ul style="list-style-type: none"> Hi-Speed USB (1) USB (1 front and 1 back) - Network interface: <ul style="list-style-type: none"> Shared 10BASE-T/100BASE-TX/1000BASE-T (RJ-45) Full duplex/Half duplex • LBP6670dn <ul style="list-style-type: none"> - USB interface: <ul style="list-style-type: none"> Hi-Speed USB (1) USB (1) - Network interface: <ul style="list-style-type: none"> Shared 10BASE-T/100BASE-TX/1000BASE-T (RJ-45) Full duplex/Half duplex
User interface	<ul style="list-style-type: none"> • LCD: <ul style="list-style-type: none"> - 132 x 65 dots F-STN liquid crystal display • LED indicator: <ul style="list-style-type: none"> - 8 • Operation key: <ul style="list-style-type: none"> - 12 (LBP6680x) / 10 (LBP6670dn)
ROM slot	1
SD card slot (LBP6680x only)	1

Software Specifications

Built-in control command	<ul style="list-style-type: none"> • LBP6680x <ul style="list-style-type: none"> - PCL5e, PCL6, PostScript 3 emulation, and UFR II • LBP6670dn <ul style="list-style-type: none"> - PCL5e, PCL6, and UFR II
Built-in fonts	<ul style="list-style-type: none"> • LBP6680x <ul style="list-style-type: none"> - PCL: <ul style="list-style-type: none"> 93 Scalable fonts, 10 Bitmap fonts - PS: <ul style="list-style-type: none"> 136 standard fonts • LBP6670dn <ul style="list-style-type: none"> - PCL: <ul style="list-style-type: none"> 45 Scalable fonts, 10 Bitmap fonts - PS (option): <ul style="list-style-type: none"> 136 standard fonts
Printable area	<ul style="list-style-type: none"> • PCL5e/PCL6: <ul style="list-style-type: none"> Data cannot be printed within a 4.2 mm margin (10 mm margin for envelopes) on all sides of the paper. • UFR II/PS (PS for LBP6670dn is an option.): <ul style="list-style-type: none"> Data cannot be printed within a 5 mm (10 mm for envelopes) margin on all sides of the paper. <p>† For details, see "Printable Area."</p>
	<ul style="list-style-type: none"> • Supported protocol <ul style="list-style-type: none"> - TCP/IP (Frame type: Ethernet II) - AppleTalk - NetWare (LBP6680x only) - SMB (option) (LBP6680x only)

Network interface

- Print application
 - LPD
 - RAW
 - IPP/IPPS
 - FTP
 - WSD

Introduction of the Optional Accessories

04L9-012

The following optional accessories are available to make full use of the printer functions.

† For the optional accessories, contact your local authorized Canon dealer.

Paper Feeder

You can load up to 500 sheets of plain paper (75 g/m²) of the following sizes in the paper feeder.

Standard sizes	A4, B5, A5, A6, Legal, Letter, and Executive
Custom paper sizes	Width 105.0 to 215.9 mm, Length 148.0 to 355.6 mm*

* If you are using the UFR II printer driver, you can load custom size paper that is 148.0 to 215.9 mm wide and 148.0 to 215.9 mm long in landscape orientation.

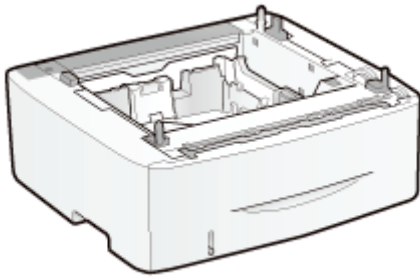

Paper Feeder Unit PF-44

IMPORTANT

Use a paper feeder designed for this printer.

Be sure to use a paper feeder designed for this printer.

NOTE

How to install the paper feeder

["Installing the Paper Feeder"](#)

PS ROM (LBP6670dn Only)

By installing PS ROM, "PostScript 3 Emulation" which makes it possible to print with PostScript is available.

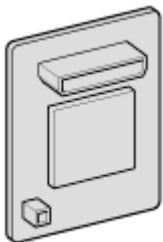

PS Printer Kit-AQ1

NOTE

How to install PS ROM

["](#)

Barcode ROM

The following function is available by installing Barcode Printing Kit-F1.

<Bar code fonts for bar code printing>

- OCR-B
- Symb. FontInform
- Symbole stethos
- BarDIMM ©1997
- USPS ZEBRA+4Stat

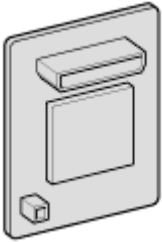

Barcode Printing Kit-F1

NOTE

How to install Barcode Printing Kit-F1

 ["Installing ROM"](#)

SD Card (LBP6680x Only)

You can use an SD card that can be built in the printer to save the received print jobs temporarily. By installing the SD card, you can use various functions such as print job spooling, encrypted secured print, secured print, and electronic sort.

† Before you dispose of this product, prevent personal information from being leaked by physically destroying the product.



SD CARD-B1

NOTE

How to install the SD card

 ["Installing SD Card"](#)

Names and Dimensions of Each Part

04L9-013

Part Name

Front View

NOTE

About the film attached to the control panel

Remove it before using the panel.

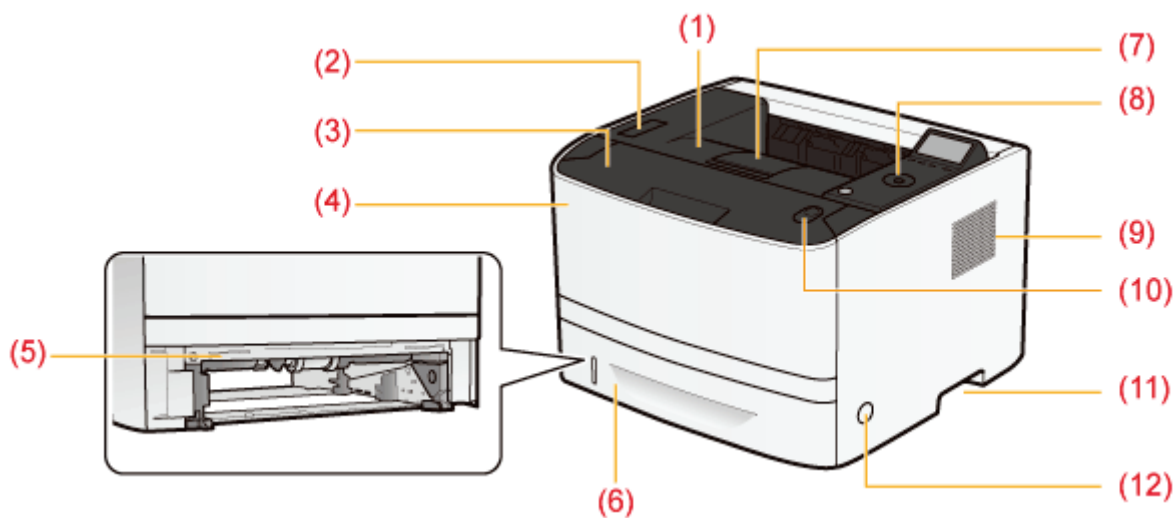

- | | | | |
|---------------------------|----------------------------------|-----------------------|-------------------|
| (1) Output tray | (4) Multi-purpose Tray | (7) Auxiliary Tray | (10) Open Button |
| (2) USB memory connector* | (5) Duplex Print Transport Guide | (8) Control Panel | (11) Lift Handles |
| (3) Front Cover | (6) Paper Drawer | (9) Ventilation Slots | (12) Power Switch |

* only for LBP6680x

Rear View

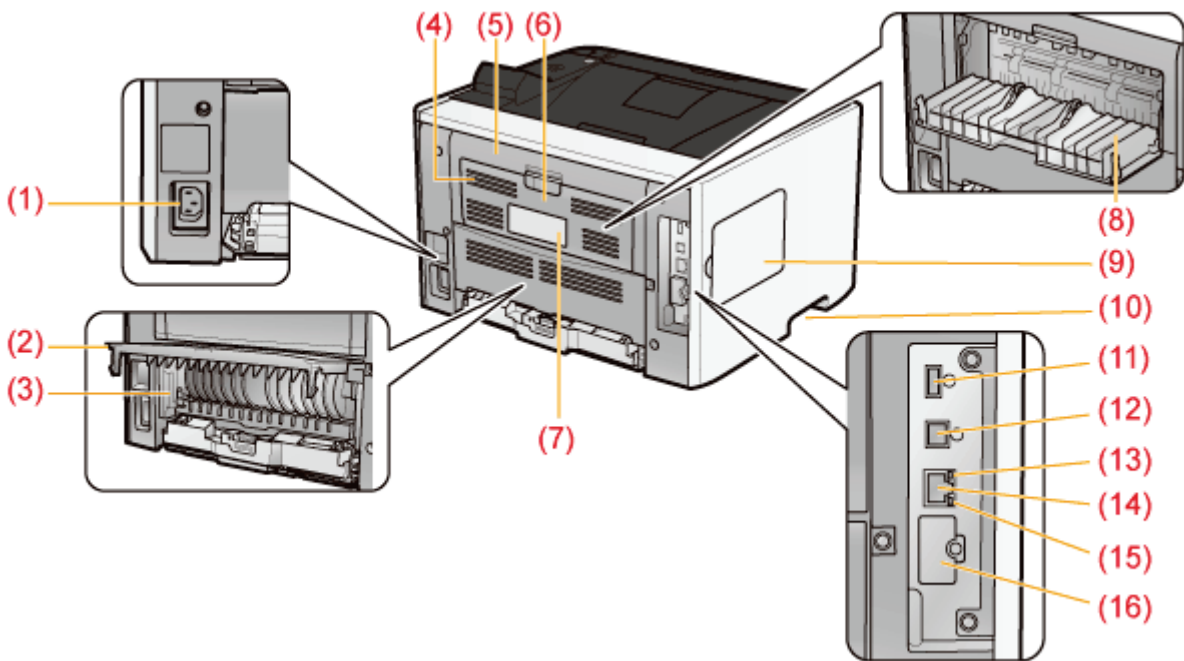

- | | | |
|-----------------------------|---|-----------------------------|
| (1) Power Socket | (7) Rating Label | (13) LNK Indicator (Green) |
| (2) Duplex Unit Cover | (8) Sub-output tray | (14) LAN Connector |
| (3) Paper Size Switch Lever | (9) Left Cover | (15) ACT Indicator (Yellow) |
| (4) Ventilation Slots | (10) Lift Handles | (16) Slot Cover* |
| (5) Back Cover | (11) USB Connector (for USB devices) | |
| (6) Output Selection Cover | (12) USB Connector (for connecting to computer) | |

* only for LBP6680x

Interior View

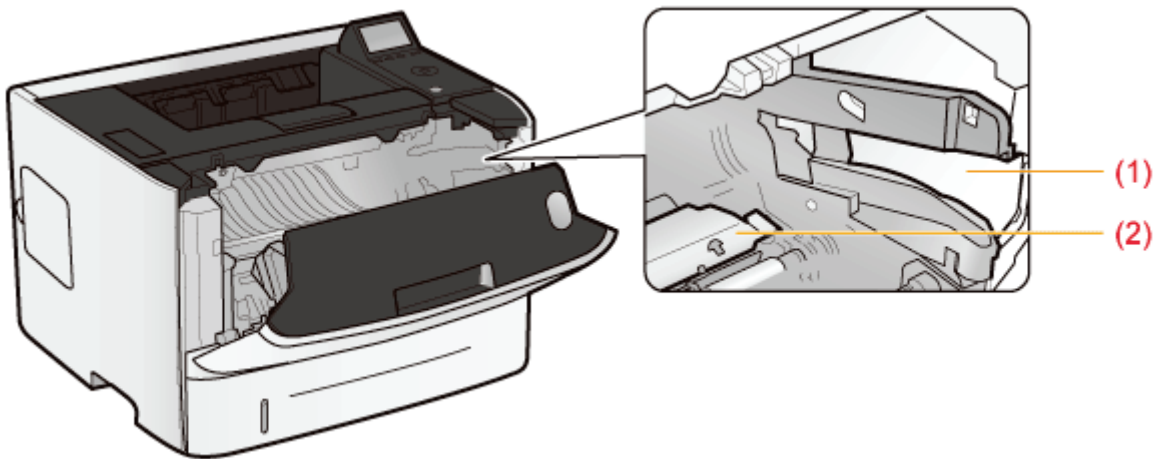

- (1) Toner Cartridge Guide (2) Transport Guide

Multi-purpose Tray

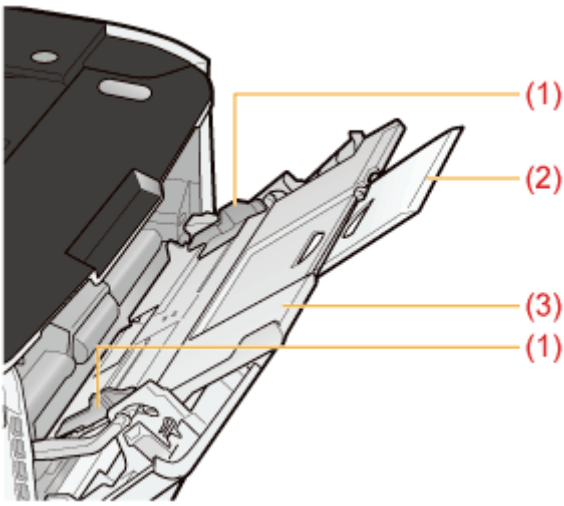

(1) Paper Guides (2) Tray Extension (3) Auxiliary Tray

Paper Drawer

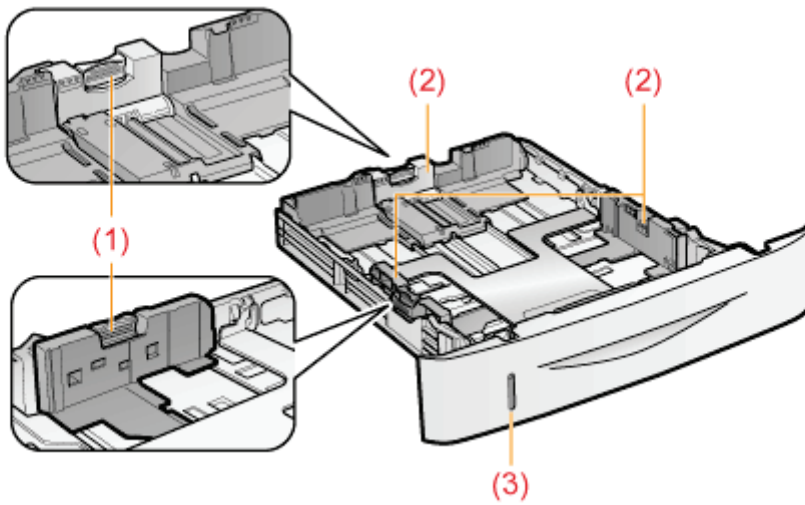

(1) Lock Release Lever (2) Paper Guides (3) Paper Level Indicator

Dimensions of Each Part

Printer

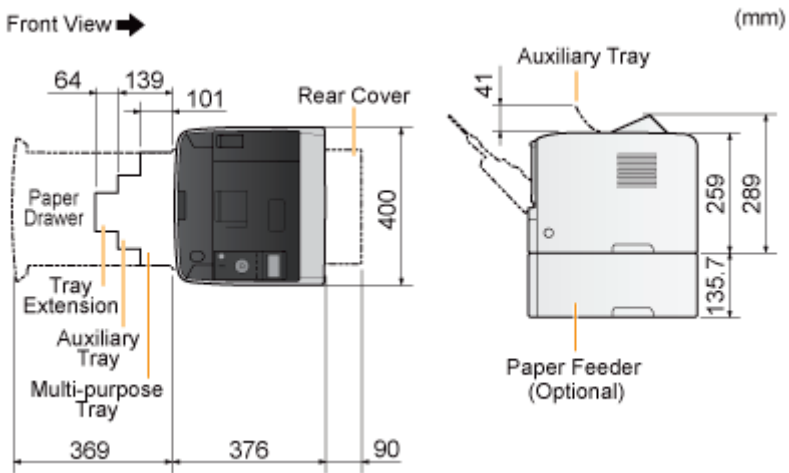

Paper Feeder Unit PF-44

Front View →

(mm)

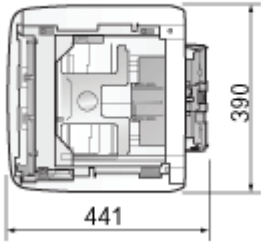

Control Panel

04L9-014

The control panel has the indicators and display which show the printer status and the keys for the printer operation.

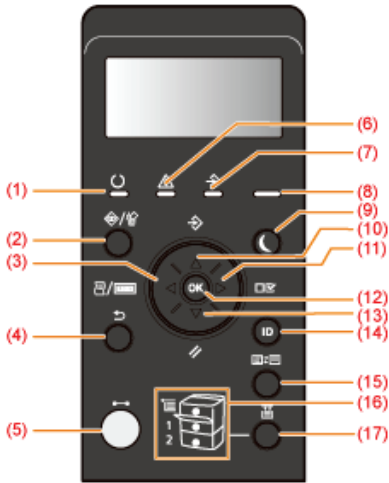















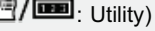



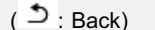









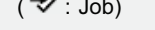



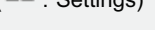

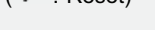

Indicators

Name	Status	Refer to	
(1) Ready Indicator	 (On)	The printer is ready to print.	—
	 (Blinking)	The printer is preparing to print.	—
(5) Online Indicator	 (On)	Online (The printer can receive print data from the computer.) If the printer enters Sleep Mode, the (Online) indicator is off even when the printer is online.	❏ "Online and Offline"
(6) Message Indicator	 (On)	A problem has occurred and printing cannot be performed. (If the printer enters Sleep Mode when it is offline, the (Message) indicator comes on even when no problem is occurring.)	❏ "The Message Indicator Is On"
(7) Job Indicator	 (On)	The printer is receiving data. Data remains in the printer memory.	—
	 (Blinking)	The printer is processing data.	—
(8) Main Power Indicator	 (On)	The power of the printer is ON.	—
(16) Paper Source Indicators	 (On)	A paper source is selected.	—
		Printing cannot be performed because no paper is loaded.	❏

	 (Blinking)	The paper drawer is not installed. (For the multi-purpose tray, the indicator comes on even when no paper is loaded.)	"Paper Loading and Output"
--	--	--	----------------------------

Keys

Name	Function (When the printer is online)	Function (When the printer is offline)	Function (While the menu is displayed)
(2)  ( : Job Status/Cancel)	If pressed when the  (Job) indicator is on or blinking (When data is being processed or received), displays the job list. Select a job from the list to cancel the job. This key is indicated as [] ( : Job Status/Cancel) in this manual.		Does not function.
(3)  ( : Utility)	Displays the [Utility Menu] menu. Prints information about the printer settings including the current settings. This key is indicated as [] ( : Utility) in this manual.	Does not function.	Goes back up the previous hierarchy. This key is indicated as [] in this manual.
(4)  ( : Back)	Does not function.		Goes back up the previous hierarchy. This key is indicated as [] ( : Back) in this manual.
(5)  ( : Online)	Switches between online and offline. The printer is online when the indicator under the key is on and is offline when the indicator is off. This key is indicated as [] ( : Online) in this manual.		
(9)  (Energy Saver)	Makes the printer to enter or recover from Sleep Mode. This key is indicated as [] (Energy Saver) in this manual.		
(10)  ( : Job)	Displays the [Job] menu. You can print various log lists. This key is indicated as [] ( : Job) in this manual.	Does not function.	Selects the next upper item in the same hierarchy. When the setting value is numeric, increases the value. If you keep holding down the key, the speed of the value increasing is increased depending on the item. This key is indicated as [] in this manual.
(11)  ( : Settings)	Displays the [Setup] menu. Configure the printing environment including the layout adjustment and scaling print output. This key is indicated as [] ( : Settings) in this manual.		Goes down the hierarchy. This key is indicated as [] in this manual.
(12)  (OK)	Does not function.		Executes the selected item. Otherwise, goes down the hierarchy. This key is indicated as [OK] in this manual.
(13)  ( : Reset)	Displays the [Reset] menu. Performs the printer reset operation, the print data output, and the shutdown operation. This key is indicated as [] ( : Reset) in this manual.		Selects the next lower item in the same hierarchy. When the setting value is numeric, reduces the value. If you keep holding down the key, the speed of the value decreasing is increased depending on the item. This key is indicated as [] in this manual.
(14)  (Log In/Out)	The log in screen for using MEAP functions is displayed. (LBP6680x only) † If you press this key while logging in, you will log out of the printer.		
It will transition to the Menu Screen. Whenever the key is pressed, the Printing Screen switches to → MEAP			

<p>(15)</p>  <p>(Application)</p>	<p>Application 1 → MEAP Application 2 ... MEAP Application 8 → USB Direct Print → Printing Screen → Menu Screen. (LBP6680x only)</p> <p>This key is indicated as [●] (Application) in this manual.</p> <p>↑ If department ID management is set and you are not logged in to the printer, the log in screen before the MEAP application display is displayed.</p>	
<p>(17)</p>  <p>(Feeder Selection)</p>	<p>Displays the [Select Feeder] menu. Specify which paper source is used to print between the paper drawer and multi-purpose tray and the paper size. This key is indicated as [●] (Feeder Selection) in this manual.</p>	<p>Does not function.</p>

Display

The display on the printer's control panel is as shown in the following. It displays the printer status, messages, items and settings of the menu functions.

When the printer is ready to print

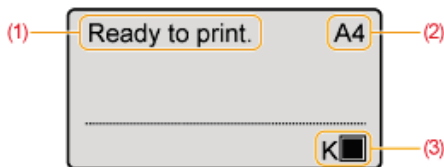

When operating the printer using the control panel

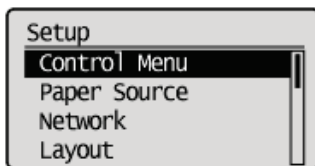

(1) Status/Operation Field

Displays the printer status and print mode.

(2) Paper Source/Paper Size Field

Displays the size of paper in the currently selected paper source using an abbreviation. The names of the following paper sizes are indicated by an abbreviation. (Legal: LG, Letter: LT, Executive: EX, Statement: ST, Envelope DL: DL, Envelope No.10: CO, Envelope ISO-C5: EC5, Envelope Monarch: MO, Envelope ISO-B5: EB5, Index Card: IC, Custom Size: 80 to 99, Custom SizeR: 80R to 99R, Mixed Sizes: FR)

(3) Toner Remaining Field

Displays the amount of toner remaining.

Introduction of the Utilities

04L9-015

The following useful utilities are available to perform the printer management and so on.

You can specify the various settings or operate the printer from a remote location. "Remote UI"

By accessing and operating the printer from the Web browser via a network, you can manage the printer using a computer in a remote location.

You can perform various operations, such as checking the current printer status or job logs and specifying various settings.

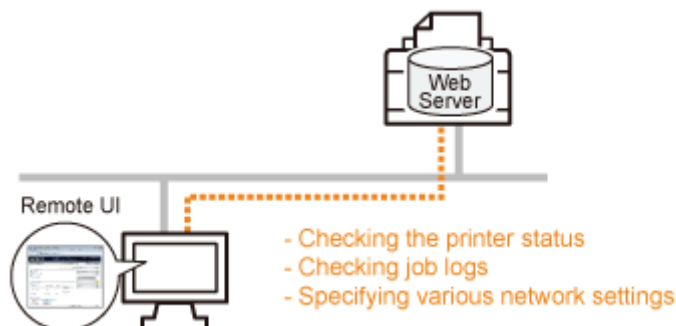

No specific software is needed.

The Remote UI can be operated in a Web browser. You do not need specific software to operate the Remote UI.

Central management of all the printer settings with the administrator password

Only the administrator can configure the settings or perform the operations related to the printer management by setting the administrator password.

You can specify the network settings at a time. "FTP Client"

By accessing the FTP server of the printer, you can specify the network settings, security settings, and so on. Because the setting items are listed in a file, you can specify multiple items all at once.

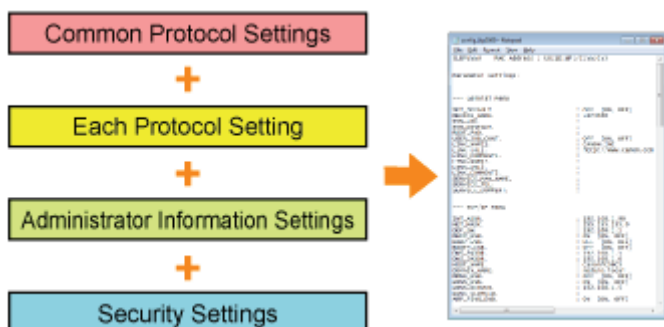

No specific software is needed.

You can operate the FTP Client using the Command Prompt supplied with Windows. You do not need specific software to operate the FTP Client.

You can check the various printer statuses. "NetSpot Device Installer"

You can view the list of statuses of the Canon devices on a network easily.

Also, you can change the default network settings or basic protocol settings.

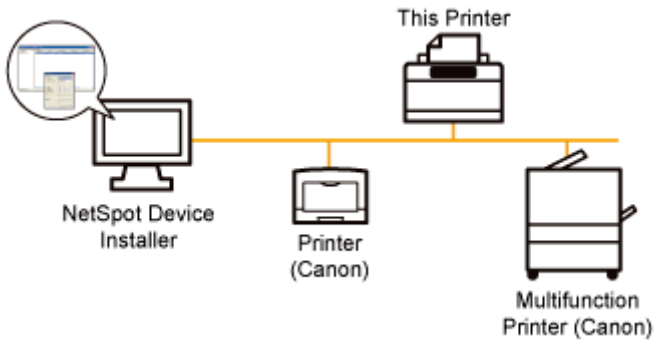

You do not need to install NetSpot Device Installer.

NetSpot Device Installer is software included in the supplied CD-ROM. You can start NetSpot Device Installer directly from the CD-ROM without installing it.

† You can also install NetSpot Device Installer on a computer.

Energy-saving Mode

04L9-0S8

You can reduce power consumption of the printer efficiently by using a sleep mode or by shutting down the printer when it is not used for a certain time.

➤ Sleep Mode

You can configure the printer to enter the sleep mode when data is not sent from the computer or when the printer status remains as it is longer than the specified time.

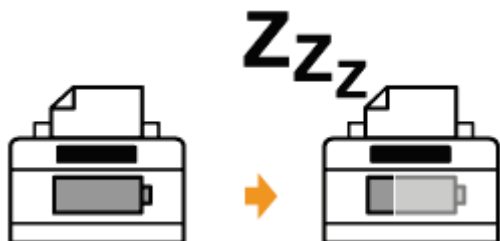

➤ Auto Shutdown

You can configure the printer to shut down when the specified time is elapsed after entering the sleep mode.



Cautions for Handling the Printer

04L9-016

This printer consists of various electronic and precision optical parts. Read the following section so that you can handle the printer properly.

Before handling the printer, see "[Important Safety Instructions](#)."

- Do not place any objects other than printing paper on the printer, trays, or covers. This may result in damage to the printer.



- Avoid shaking the printer. This may result in poor print quality or damage to the printer.

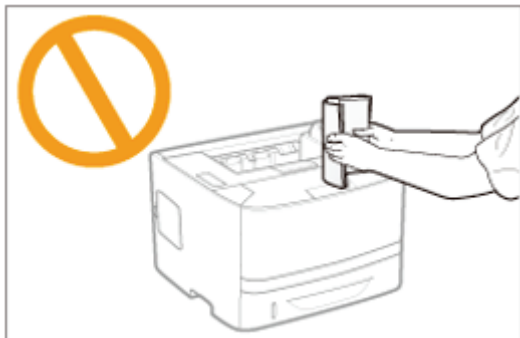

- Do not leave any covers open longer than required. Exposing the printer to direct sunlight or strong light may result in deterioration in print quality.
- Do not open the covers on the printer during printing. This may result in damage to the printer.
- Handle each cover gently when opening or closing it. Failure to do so may result in damage to the printer.
- If you want to put a cover on the printer to prevent dust from entering the printer, turn the power OFF and allow the printer to cool down sufficiently before covering the printer.
- If you do not plan to use the printer for a long period of time, unplug the power plug from the AC power outlet.
- Do not use or store the printer in a room where chemicals are used.

Consumables

04L9-017

The following consumables are provided for this printer. Purchase them at your local authorized Canon dealer. Use the following table as rough guides to replace consumables. However, you may need the replacement earlier than the described lifetimes depending on the printer installation environment, paper size, or document type.

Consumables	Replacement Timing	Replacement Method
Canon Cartridge 719	Average yield: 2,100 sheets *1 *2	➤ "Replacing the Toner Cartridge"
Canon Cartridge 719 H	Average yield: 6,400 sheets *1 *2	

1 The average yield is on the basis of "ISO/IEC 19752" when printing A4 size paper with the default print density setting.

* "ISO/IEC 19752" is the global standard related to "Method for the determination of toner cartridge yield for monochromatic electrophotographic printers and multi-function devices that contain printer components" issued by ISO (International Organization for Standardization).

*2 When the toner cartridge needs to be replaced soon, the following messages will appear in the control panel.

➤ "Toner Cartridge Replacement"

IMPORTANT

About replacement toner cartridges

For optimum print quality, using Canon genuine toner cartridges is recommended.

Model Name	Supported Canon Genuine Toner Cartridge
LBP6680x/LBP6670dn	Canon Cartridge 719 Canon Cartridge 719 H

Be careful of counterfeit toner cartridges.

Please be aware that there are counterfeit Canon toner cartridges in the marketplace. Use of counterfeit toner cartridge may result in poor print quality or machine performance. Canon is not responsible for any malfunction, accident or damage caused by the use of counterfeit toner cartridge. For more information, see <http://www.canon.com/counterfeit>.

NOTE

Toner and Toner Cartridge Availability

Toner cartridge for this machine will be available for at least seven (7) years (or any such longer period as required by applicable laws) after production of this machine model has been discontinued.

➤ **Toner Cartridge Replacement**

- Before Replacing the Toner Cartridge
- Replacing the Toner Cartridge
- Storing Toner Cartridges

➤ **Adjusting the Printing Position**

- Adjusting the Printing Position for All the Jobs
- Adjusting the Printing Position for Each Paper Source

➤ **Moving the Printer**

➤ **Cleaning and Maintaining the Printer**

- Cleaning the Inside of the Printer
- Cleaning the Outside of the Printer

➤ **Location of the Serial Number**

Toner Cartridge Replacement

04L9-019

† For details on the yield of the toner cartridge or replacement toner cartridges, see "[Consumables](#)."

Toner cartridges are consumable products. When the toner cartridge is nearing the end of its life, the following symptoms occur.

- <16 Tnr cart. will soon reach end of lifetime.> or <Toner cartridge will soon reach end of lifetime.> appears in the [Control Panel](#).

16 Tnr cart. will soon reach end of lifetime.

Toner cartridge will soon reach end of lifetime.

For details on the contents of and the solutions for the above messages, see "[If a Message Appears in the Display](#)."

- White streaks, unevenness, or faded print appears on printout results.



▼ If these types of symptom occur

Perform the procedure described in the following section before replacing the toner cartridge. You may be able to print for a while until the toner is used up completely.

- "[Before Replacing the Toner Cartridge](#)"

▼ If the printout result is not improved

If white streaks, unevenness, or faded print appears on printout results even after performing the above procedure, replace the toner cartridge with a new one.

- "[Replacing the Toner Cartridge](#)"

<In cases such as where you do not immediately replace the toner cartridge with a replacement toner cartridge after purchasing it>



Pay attention to the points described in the following section to store it.

- "[Storing Toner Cartridges](#)"

If a Message Appears in the Display

Toner cartridges are consumable products. When a toner cartridge is nearing the end of its life, a message will appear in the display. Follow the directions in the message.

Message	When it is Displayed	Contents and Solutions
<16 Tnr cart. will soon reach end of lifetime.>	When the toner cartridge needs to be replaced soon	<ul style="list-style-type: none"> • You can continue to print. • Have ready a new toner cartridge. • We recommend that you replace the toner cartridge before printing a large amount of data.

<p><Toner cartridge will soon reach end of lifetime.></p>	<p>When the toner cartridge needs to be replaced soon</p>	<ul style="list-style-type: none"> • The printer stops printing. • Pressing [] ( : Online) continues the job. • Have ready a new toner cartridge. • We recommend that you replace the toner cartridge before printing a large amount of data.
---	---	--

† Whether <16 Tnr cart. will soon reach end of lifetime.> or <Toner cartridge will soon reach end of lifetime.> appears when the toner is running out depends on the setting for [Warning Step] in the [Setup] menu. The printer is set to display <16 Tnr cart. will soon reach end of lifetime.> in the default settings. For details on the setting for [Warning Step], see "[\[Setup\] Menu \(\[Control Menu\] Options\)](#)."

Attention (Toner Cartridge)

04L9-01A

Before replacing the toner cartridge, see "Important Safety Instructions" and "Storing Toner Cartridges."

IMPORTANT

About replacement toner cartridges

For optimum print quality, using Canon genuine toner cartridges is recommended.

Model Name	Supported Canon Genuine Toner Cartridge
LBP6680x/LBP6670dn	Canon Cartridge 719 Canon Cartridge 719 H

Be careful of counterfeit toner cartridges.

Please be aware that there are counterfeit Canon toner cartridges in the marketplace.

Use of counterfeit toner cartridge may result in poor print quality or machine performance.

Canon is not responsible for any malfunction, accident or damage caused by the use of counterfeit toner cartridge.

For more information, see <http://www.canon.com/counterfeit>.

Hold the toner cartridge properly.

When handling the toner cartridge, hold it properly as shown in the figure. Do not place it vertically or upside-down.

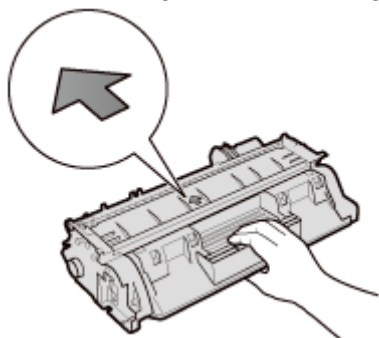

Do not touch the electrical contacts (A) or the toner cartridge memory (B), and do not open the drum protective shutter (C).

Touching the electrical contacts (A) or the toner cartridge memory (B) may cause damage.

Also, print quality may deteriorate if you touch or damage the photosensitive drum inside the toner cartridge. Do not touch or open the drum protective shutter (C).



Do not touch the high-voltage contacts (D) or the electrical contacts (E).

This may result in damage to the cartridge.

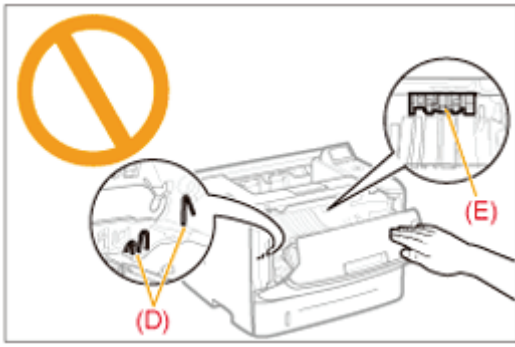

Other precautions

- Do not expose the toner cartridge to direct sunlight or strong light.
- Do not attempt to disassemble or modify the toner cartridge.
- Condensation (water droplets on the inside or outside) may form on the toner cartridge when it is brought into an environment with a sudden change in temperature or humidity.
When moving a new toner cartridge to a location with change in temperature, leave the cartridge in the protective bag at the new location for two or more hours to allow it to adjust to the new temperature.
- Do not leave the front cover open for a long time with the toner cartridge installed.
- Keep toner cartridge away from products that generate magnetic waves, such as a computer or computer display.
- A toner cartridge is a magnetic product. Keep the toner cartridge away from products that may be damaged by magnetism, such as a floppy disk or disk drive. This may lead to damage to data.

NOTE

About illustrations of the toner cartridge

The e-Manual describes the procedure using illustrations of Canon Cartridge 719.

About the packing materials

The packing materials may be changed in form or placement, or may be added or removed without notice.

Before Replacing the Toner Cartridge

04L9-0RH

If the message <16 Tnr cart. will soon reach end of lifetime.> or <Toner cartridge will soon reach end of lifetime.> appears, or if white streaks, unevenness, or faded print appears on printout results, perform the following procedure before replacing the toner cartridge. You may be able to print for a while until the toner is used up completely.

Before performing the following procedure or replacing the toner cartridge, see "Attention (Toner Cartridge)."

1

Open the front cover while pressing the open button.

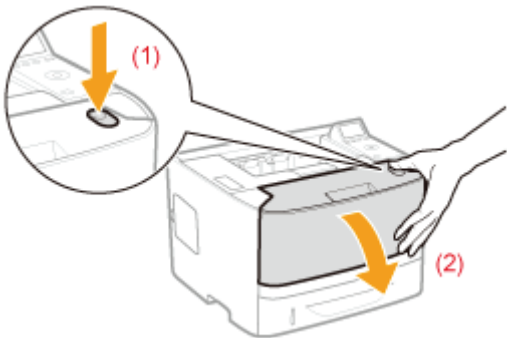

2

Remove the toner cartridge.

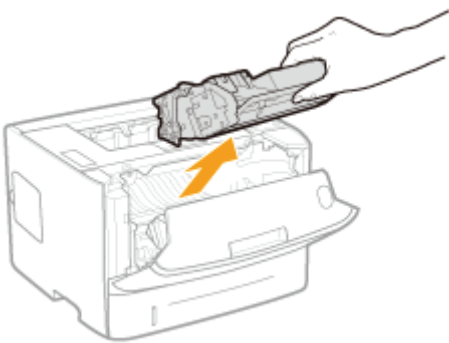

3

Shake the toner cartridge five or six times as shown in the figure to evenly distribute the toner inside the cartridge.

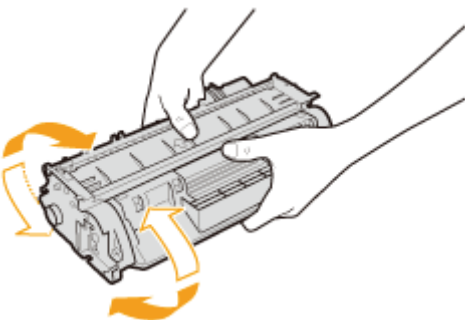

4

Install the toner cartridge.

Push the toner cartridge into the printer firmly until it touches the back of the printer while aligning (A) on both sides of the toner cartridge with the toner cartridge guides inside the printer.

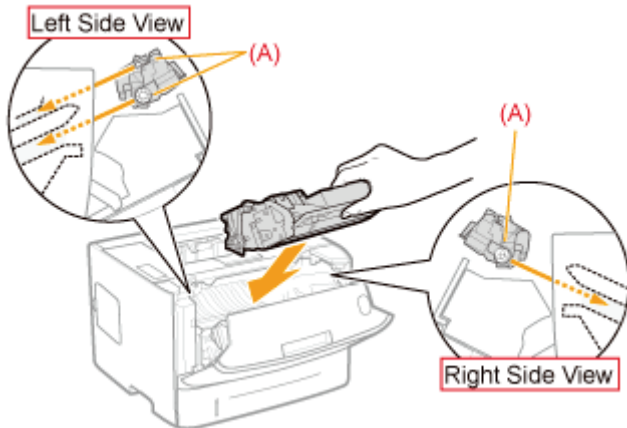

5

Close the front cover.

? If you cannot close the front cover

Make sure that the toner cartridge is installed in the printer properly. Do not try to forcefully close the front cover, as this may damage the printer

 If white streaks, unevenness, or faded print appears on printout results even after performing the above procedure, replace the toner cartridge with a new one.

 ["Replacing the Toner Cartridge"](#)

Replacing the Toner Cartridge

04L9-01C

Before replacing toner cartridges, see "Attention (Toner Cartridge)."

1

Open the front cover while pressing the open button.

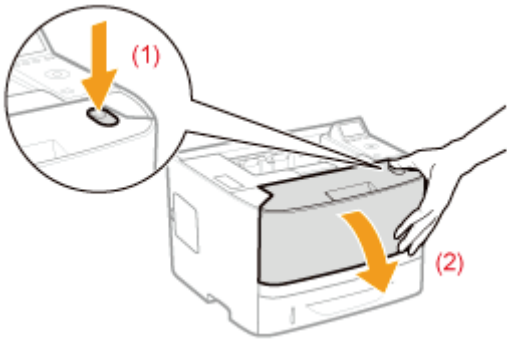

2

Remove the toner cartridge.

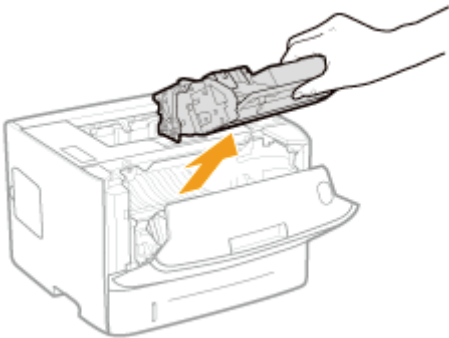

3

Take out the new toner cartridge from the protective bag.

You can open the protective bag with your hands from the notch.

† Keep the protective bag. Do not discard it. You will need it when you remove the toner cartridge for printer maintenance or other purposes

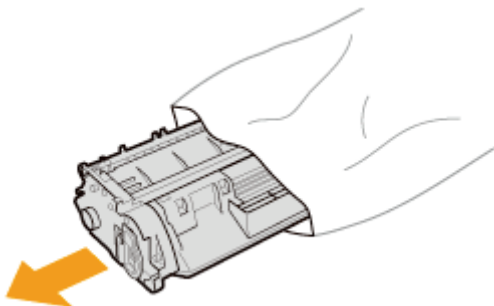

4

Shake the toner cartridge five or six times as shown in the figure to evenly distribute the toner inside the cartridge.

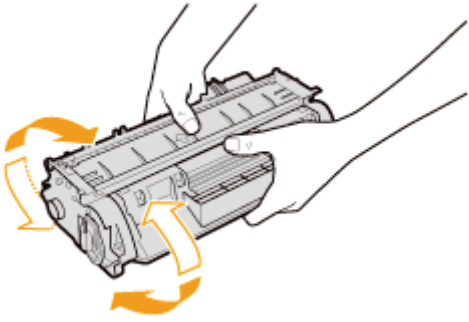

5

Place the toner cartridge on a flat surface.

6

Fold the tab, and then pull out the sealing tape (approx. 48 cm).

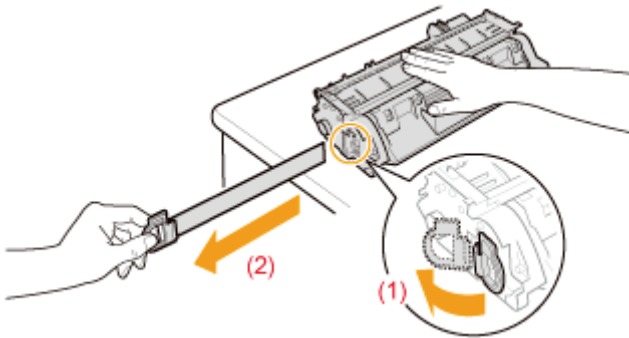

IMPORTANT

Precautions when pulling out the sealing tape

- Do not pull the sealing tape diagonally, upward, or downward. If the tape is severed, this may become difficult to pull out completely.

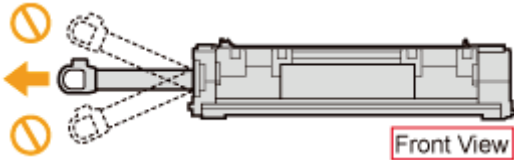

- If the sealing tape stops at midpoint, pull it out of the toner cartridge completely. If any tape remains in the toner cartridge, this may result in low print quality.
- Dispose of the removed sealing tape according to local regulations.

7

Install the toner cartridge.

Push the toner cartridge into the printer firmly until it touches the back of the printer while aligning (A) on both sides of the toner cartridge with the toner cartridge guides inside the printer.

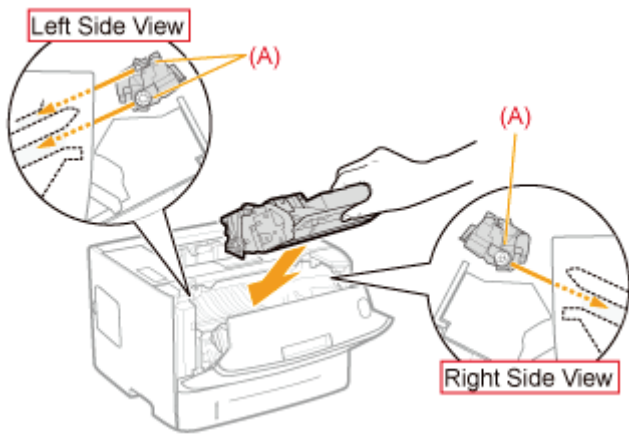

8

Close the front cover.

? If you cannot close the front cover

Make sure that the toner cartridge is installed in the printer properly. Do not try to forcefully close the front cover, as this may damage the printer.

Storing Toner Cartridges

04L9-01E

Be careful of the following points when storing a new toner cartridge or handling a toner cartridge that was taken out of the printer for maintenance or moving the printer.

IMPORTANT

Precautions when storing toner cartridges

To use toner cartridges in a safe and trouble-free manner, store them in a place that fulfills the following conditions.

- Do not store toner cartridges in a location exposed to direct sunlight.
- Do not store toner cartridges in a location subject to high temperature or humidity or in a location with dramatic changes in temperature or humidity.
 - Storage temperature range: 0 to 35°C (32 to 95°F)
 - Storage humidity range: 35 to 85% RH (no condensation)
- Do not store toner cartridges in a location exposed to corrosive gases, such as ammonia, salt air, or large amounts of dust.
- Keep toner cartridges out of the reach of small children.
- Keep toner cartridges away from products that may be damaged by magnetism, such as a floppy disk or disk drive.

Store toner cartridges in the same orientation as when they are installed in the printer.

Do not store toner cartridges vertically or upside-down.

When removing the toner cartridge which is being used from the printer

Immediately put it in the original protective bag or wrap it with a thick cloth.

About a new toner cartridge

Do not take a new toner cartridge out of the protective bag until it is ready to be used.

NOTE

About condensation

Even when toner cartridges are stored within the recommended humidity range, water droplets may form on the inside or outside of the cartridges when moved to an environment with a sudden change in temperature or humidity. The formation of water droplets is called condensation.

Condensation will adversely affect the quality of toner cartridges.

Adjusting the Printing Position

04L9-01F

If you want to adjust the printing position for all the jobs

You can adjust the printing position for all the jobs at once.

- ["Adjusting the Printing Position for All the Jobs"](#)

If you want to adjust the printing position for each paper source

You can adjust the printing position for each paper source by printing the Position Adjustment Print.

- ["Adjusting the Printing Position for Each Paper Source"](#)
-

Adjusting the Printing Position for All the Jobs

04L9-01H

Perform [Offset Y] and [Offset X] using the control panel of the printer.

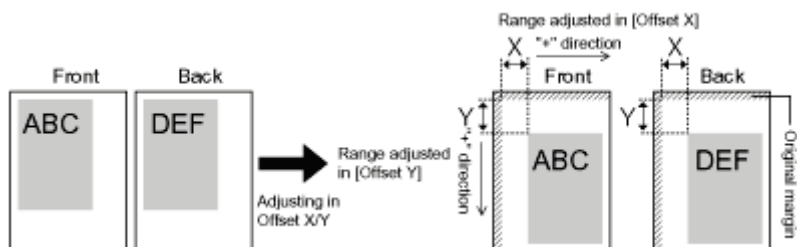

IMPORTANT

Confirm the adjustment result.

If any part of the print image lies outside the printable area after adjusting the printing position, the part will be missing in the print result.

NOTE

Adjustable area

You can adjust the printing position between -50.0 mm and +50.0 mm for both the vertical direction and horizontal direction.

1

Press [] ( : Settings).

2

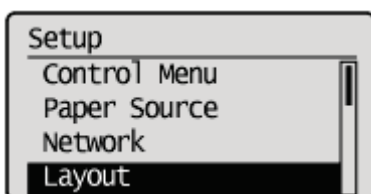

Select [Layout] using [] and [], and then press [OK].



3

Select a position you want to correct.

If specifying the setting for [Offset Y]

1. Select [Offset Y] using [] and [], and then press [OK].

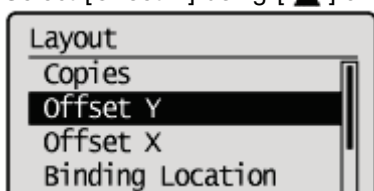

2. Specify the target numeric value using [▲] and [▼], and then press [OK].

Each time you press [▲], the setting value increases by 0.5 mm, and each time you press [▼], the setting value decreases by 0.5 mm. Also, if you keep pressing [▲] or [▼] without releasing your finger, you can keep increasing or decreasing the value.

→ The setting value is changed.

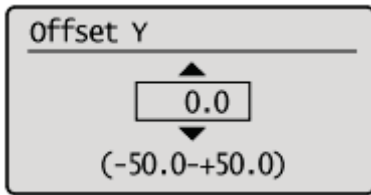

If specifying the setting for [Offset X]

1. Select [Offset X] using [▲] and [▼], and then press [OK].

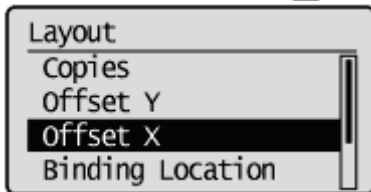

2. Specify the target numeric value using [▲] and [▼], and then press [OK].

Each time you press [▲], the setting value increases by 0.5 mm, and each time you press [▼], the setting value decreases by 0.5 mm. Also, if you keep pressing [▲] or [▼] without releasing your finger, you can keep increasing or decreasing the value.

→ The setting value is changed.

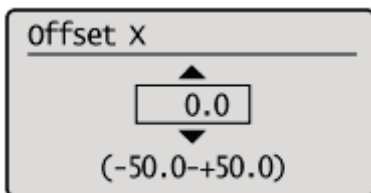

Adjusting the Printing Position for Each Paper Source

04L9-01J

If the printing position is skewed when printing from a certain paper source, you can adjust the position from the control panel.

IMPORTANT

Confirm the adjustment result.

If any part of the print image lies outside the printable area after adjusting the printing position, the part will be missing in the print result.

NOTE

Be careful of the orientation for 2-sided printing

The orientation of the images on the reverse pages varies depending on the printing orientation or setting for [Binding Location].

Checking the Printing Position

Perform the Printing Position Adjustment Print and check the position and direction to be adjusted.

IMPORTANT

Adjusting the printing position for 2-sided printing

Set [2-Sided Printing] to [On] in advance.

1

Press [] ( : Feeder Selection).

2

Select [Paper Source] using [] and [], and then press [OK].

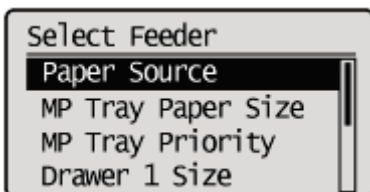

3

Select the paper source that you want to check the printing position using [] and [], and then press [OK].

When adjusting the printing position for 2-sided printing, select the desired paper source.

† [Drawer 2] is displayed only when the optional paper feeder(s) is (are) installed.

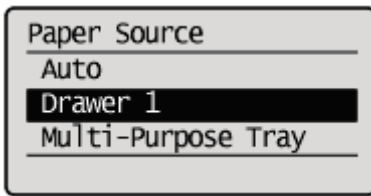

4

Press [] (↔ : Online).

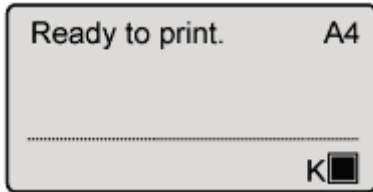

5

Make sure that the printer is online.

If the printer is not online, press [] (↔ : Online).

6

Press [] ( / ): Utility).

7

Select [Printing Pos. Print] using [▲] and [▼], and then press [OK].

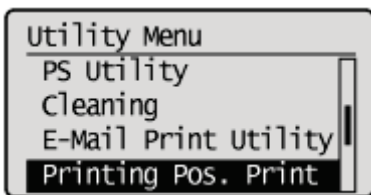

8

Select [Yes] using [▼], and then press [OK].

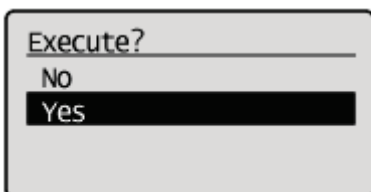

→ The Printing Position Adjustment Print is printed. The top of the output paper is the top of the Printing Position Adjustment Print.

 Next, check the printout results and specify the direction and position to be adjusted in "Adjusting the Printing Position" (See the next item).

Adjusting the Printing Position

Next, check the printout results of the Printing Position Adjustment Print and specify the direction and position to be adjusted.

The measurements of "田" printed on paper are as the following:

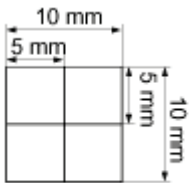

* 5 mm from each edge of paper

This section describes the setting procedure for the following Printing Position Adjustment Print printed with Drawer 1 specified, as an example.

In this case, adjust "Y position" by "-5.0 mm" because the printing position of (A) should be moved upward by 5 mm.

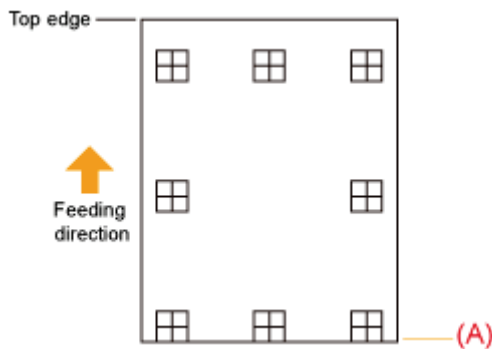

IMPORTANT

Adjusting the printing position for 2-sided printing



- Adjust the printing position of the first page using [Offset Y (2-Sided)] and [Offset X (2-Sided)].
- The printing position of the second page depends on the settings for each paper source.

NOTE

Adjustable area

The printing position can be adjusted within a range from -5.0 to +5.0 mm.

1

Press [] ( : Online).

The  (Online) indicator goes off, allowing you to specify the settings on the control panel.

2

Press [] ( : Settings).

3

Select [User Maintenance] using [] and [], and then press [OK].

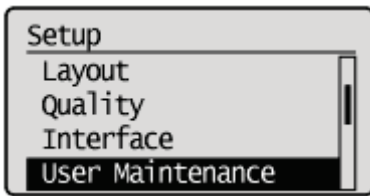

4

Select [Adj. Start Position] using [▲] and [▼], and then press [OK].

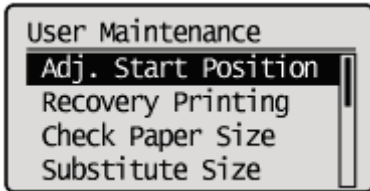

5

Select the direction and paper source that you want to check the printing position using [▲] and [▼], and then press [OK].

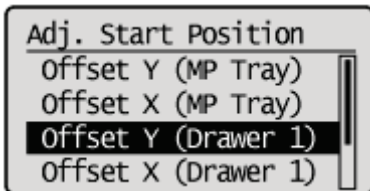

6

Specify the target numeric value using [▲] and [▼], and then press [OK].

Check the printout results of the Printing Position Adjustment Print and select the numerical value to adjust the position. Each time you press [▲], the value increases in +0.1 mm increments, and each time you press [▼], the value decreases in -0.1 mm increments. If you keep holding down [▲] or [▼], the value changes consecutively.

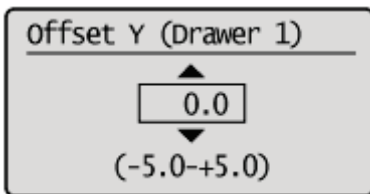

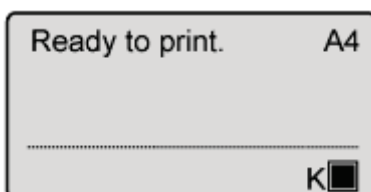

7

Press [○] (↔ : Online).



8

Make sure that the printer is online.

If the printer is not online, press [] ( : Online).

9

Press [] ( : Utility).

10

Select [Printing Pos. Print] using [] and [], and then press [OK].

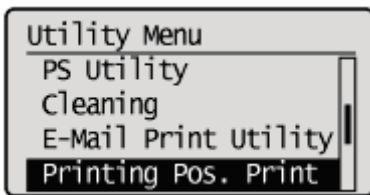

11

Select [Yes] using [], and then press [OK].

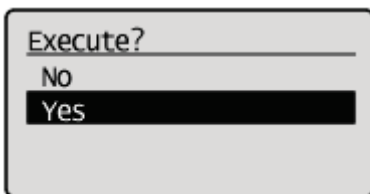

† The Printing Position Adjustment Print in which the setting is changed is printed.

† Check the printout results to confirm the printing position. To make further adjustment, repeat Steps 1 to 11.

Moving the Printer

04L9-01K

When changing the location of the printer or moving the printer for maintenance, be sure to perform the following procedure.

† For details on the installation site, see "Confirming the Supplied Accessories and Checking the Installation Site."

Before moving the printer, see "Important Safety Instructions."

1

Turn the printer OFF, and then disconnect the cables or cords from the printer.

† Shut down the printer before turning it OFF.
For details on the procedure for shutting down the printer, see "Turning the Printer ON/OFF."

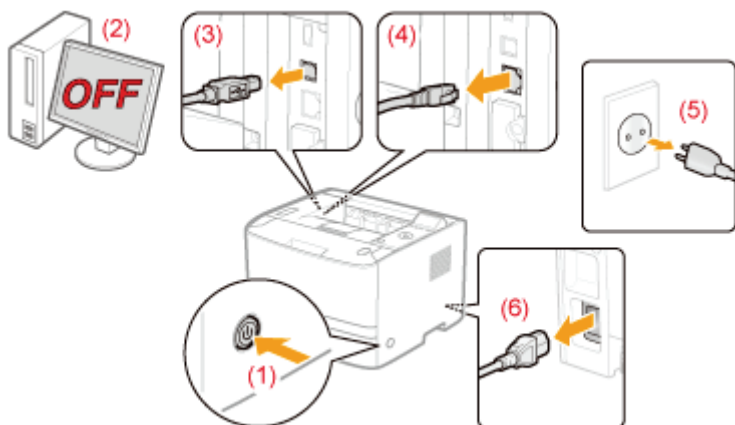

<How to disconnect the cable or cord>

USB cable*	(2) Turn the computer OFF. (3) Disconnect the cable from the printer.
LAN cable*	(4) Disconnect the cable from the printer.
Power cord	(5) Disconnect the power plug from the AC power outlet. (6) Disconnect the cord from the printer.

* Whether the cable is connected or not varies depending on your environment.

2

Pull out the paper drawer.

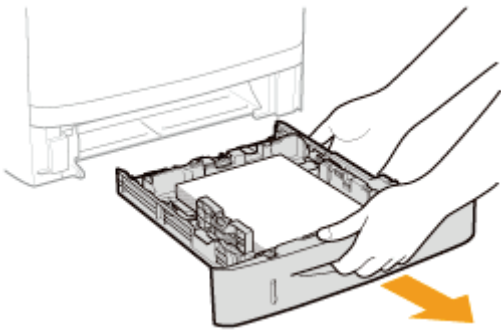

3

Carry the printer unit to the installation site.

After confirming that the covers and trays are closed, carry the printer by holding it by the lift handles from the front side.

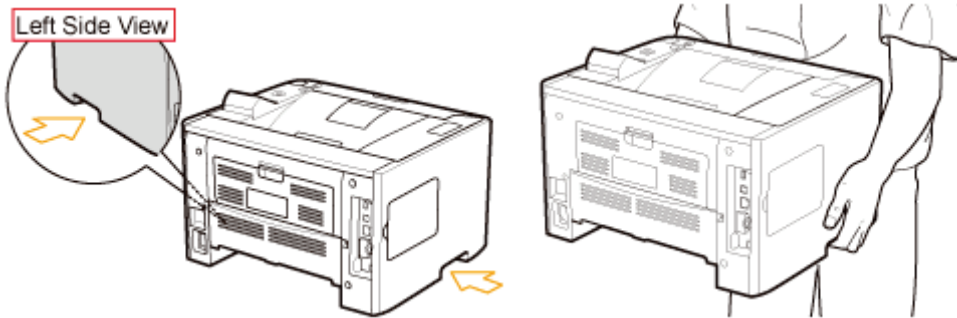

If the optional paper feeder is installed

Remove the paper feeder from the printer, place the paper feeder on the new installation site, and then carry the printer to the site.

Removing the paper feeder from the printer may be difficult. Be careful when removing the paper feeder from the printer.

† Do not carry the printer with the paper feeder installed. If you do so, the paper feeder may drop resulting in personal injury.



† For details on the procedure for installing the paper feeder, see "[Installing the Paper Feeder.](#)"

4

Set the paper drawer in the printer.

Push it in the printer firmly.

5

Connect the removed cable or cord.

<How to connect the cable or cord>

USB cable *	Connect to the USB connector on the printer.
LAN cable *	Connect to the LAN connector on the printer.
Power cord	(1) Plug the power cord to the power socket on the printer. (2) Plug the power plug in the AC power outlet.

* Whether the cable is connected or not varies depending on your environment.

When transporting the printer unit

To prevent damage to the printer during transport, perform the following.

- **Remove the toner cartridge.**

† Before removing the toner cartridge, see "[Storing Toner Cartridges.](#)"

- **Securely pack the printer in the original box with packing materials.**

† If the original box and packing materials are not available, find an appropriate box along with packing materials and pack the printer and the parts appropriately.

Cleaning and Maintaining the Printer

04L9-01L

↳ Cleaning the Inside of the Printer

If the printed paper has smudge marks, clean the inside of the printer.
Print quality deterioration can be prevented by cleaning the inside of the printer.

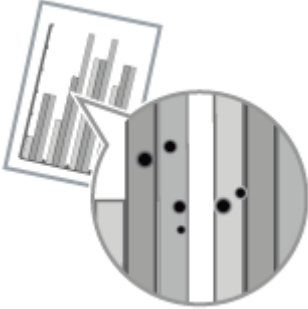

↳ Cleaning the Outside of the Printer

Periodically clean the outer surfaces and ventilation slots of the printer to maintain the optimal printing quality.



Cleaning the Inside of the Printer

04L9-01W

Clean the following if dirt sticks to printed paper.

❖ ["Cleaning the Fixing Roller of the Printer"](#)

Cleaning the Fixing Roller of the Printer

04L9-01X

If the printed paper has smudge marks, clean the fixing roller using the following procedure.

† A4 or Letter plain paper is required to clean the fixing roller. Have A4 or Letter plain paper ready.



1

Load A4 plain paper in the multi-purpose tray.

➤ "Loading Paper in the Multi-purpose Tray"

2

Make sure that the printer is online.

If the printer is not online, press [] ( : Online).

3

Press [] ( : Utility).

4

Select [Cleaning] using [▲] and [▼], and then press [OK].

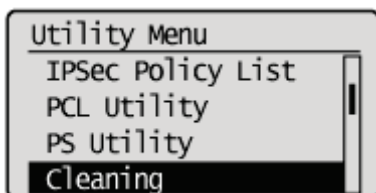

5

Select the size of the paper loaded in the multi-purpose tray using [▲] and [▼], and then press [OK].

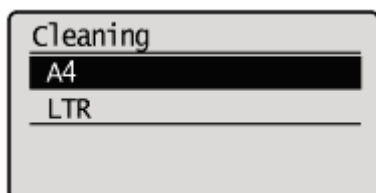

6

Select [Yes] using [▼], and then press [OK].

→ <Insert paper to be used for cleaning page.> is displayed on the display.

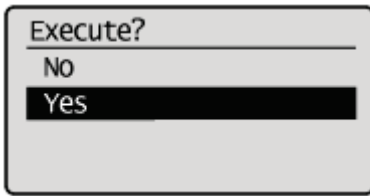

7

Press [] (↔ : Online).

- The cleaning paper is printed.
- <Set cleaning paper and press the Online key.> is displayed on the display.

 Next, clean the fixing roller using the printed cleaning page.

8

If any paper is loaded in the multi-purpose tray, remove it.

9

Load the cleaning page with the printed side face-up and the arrow mark going into the multipurpose tray first.

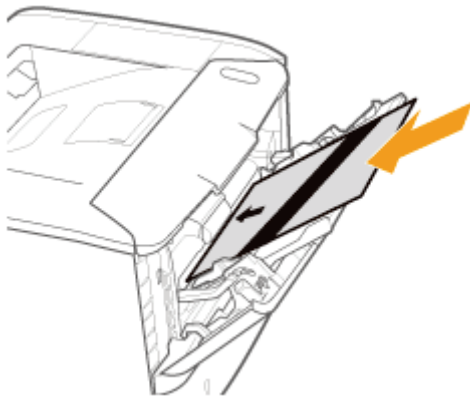

10

Press [] (↔ : Online).

- The paper is fed into the printer slowly, and the printer starts cleaning the fixing roller.

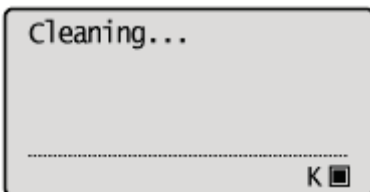

NOTE

Cleaning time

It takes approximately 57 seconds.

- † Cleaning the fixing roller cannot be canceled. Please wait until it is completed.

(The cleaning is finished when the paper is output completely.)

The front or back of the printed paper has smudge marks even after performing the above procedure.

Perform the cleaning again. When doing so, do not use the cleaning paper output but load A4/Letter blank paper in the multi-purpose tray, and then perform the cleaning.

Cleaning the Outside of the Printer

04L9-020

Before cleaning, see "Attention (Cleaning)."

1

Turn the printer OFF, and then disconnect the cables or cords from the printer.

- † Shut down the printer before turning it OFF.
For details on the procedure for shutting down the printer, see "Turning the Printer ON/OFF."

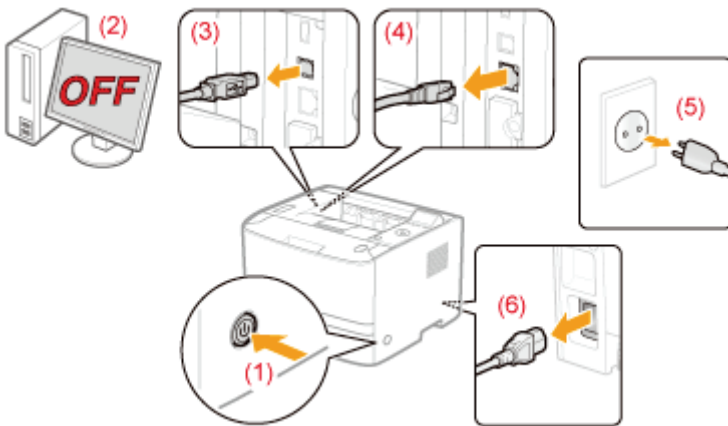

<How to disconnect the cable or cord>

USB cable*	(2) Turn the computer OFF. (3) Disconnect the cable from the printer.
LAN cable*	(4) Disconnect the cable from the printer.
Power cord	(5) Disconnect the power plug from the AC power outlet. (6) Disconnect the cord from the printer.

* Whether the cable is connected or not varies depending on your environment.

2

Firmly wring a soft cloth dampened with water or a mild detergent diluted with water, and wipe off the dirt.



3

After wiping off the dirt, wipe the printer with a dry cloth.

4

When the printer is completely dry, connect the removed cable or cord.

<How to connect the cable or cord>

USB cable*	Connect to the USB connector on the printer.
LAN cable*	Connect to the LAN connector on the printer.
Power cord	(1) Plug the power cord to the power socket on the printer. (2) Plug the power plug in the AC power outlet.

* Whether the cable is connected or not varies depending on your environment.

Before cleaning the printer, see "[Important Safety Instructions](#)."

IMPORTANT

Precautions when cleaning the printer

- Do not use a cleaning agent other than water or a mild detergent diluted with water, as this may deform or crack the plastic materials in the printer.
- When using a mild detergent, be sure to dilute it with water.
Also, if you use a mild detergent for cleaning, be sure to wipe away the detergent with a soft cloth dampened with water.
- Grease or oil does not have to be applied to this printer. Be sure not to apply grease or oil.

Location of the Serial Number

04L9-022

The serial number is required for receiving maintenance service.

You can find the serial number at the location shown in the following figures.

† Do not remove the labels on which the serial number is indicated.

Rear side of the printer

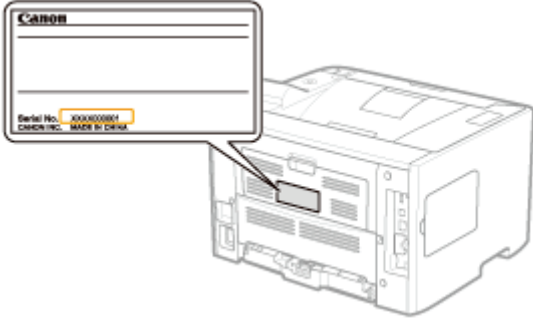

Outside view of the packaging box

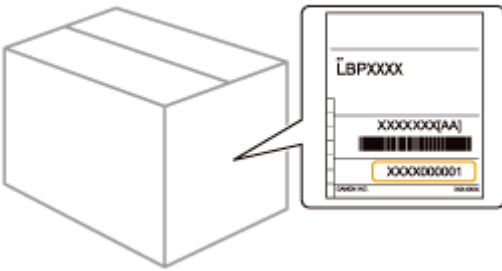

Printer Installation

04L9-023

Perform the following procedures according to your installation preference.

Before installing the printer, see "Attention (Printer Installation)."

1	Checking before Installing the Printer <ul style="list-style-type: none"> Confirming the Supplied Accessories Checking the Installation Site 	<ul style="list-style-type: none"> "Confirming the Supplied Accessories and Checking the Installation Site"
2	Removing the Packing Materials	<ul style="list-style-type: none"> "Removing the Packing Materials"
3	Installing the Paper Feeder (Only when installing the paper feeder)	<ul style="list-style-type: none"> "Installing the Paper Feeder"
	Installing ROM (Only when installing ROM)	<ul style="list-style-type: none"> "Installing ROM"
	Installing SD Card (Only Installing SD Card)	<ul style="list-style-type: none"> "Installing SD Card (LBP6680x Only)"
4	Installing the Printer <ul style="list-style-type: none"> Carrying the Printer to the Installation Site Connecting the Power Cord 	<ul style="list-style-type: none"> "Installing the Printer"
5	Specifying the Printer's Initial Settings	<ul style="list-style-type: none"> "Turning the Power On and Specifying a Language"
	Specifying a Type of Printer Driver	<ul style="list-style-type: none"> "Specifying a Type of Printer Driver"
6	Loading Paper	<ul style="list-style-type: none"> "Loading Paper in the Paper Drawer" "Loading Paper in the Multi-purpose Tray"
7	Connecting to a Computer	<ul style="list-style-type: none"> "Connecting to a Computer"
8	Installing the Printer Driver	<ul style="list-style-type: none"> "For Windows" "For Macintosh"
9	Checking the Printing Operation	Check the operations by Test Page in Windows. <ul style="list-style-type: none"> "Basic Operations/Various Information for Windows"



Attention (Printer Installation)

04L9-024

Before installing the printer, see "[Important Safety Instructions](#)."

IMPORTANT

Protecting the printer from condensation

- To prevent condensation from forming inside the printer in the following cases, adjust the printer to the ambient temperature and humidity for at least two hours before use.
 - When the room where the printer is installed is heated rapidly
 - When the printer is moved from a cool or dry location to a hot or humid location
- If water droplets (condensation) form inside the printer, this can result in paper jams or poor print quality.

Precautions for the power supply

- Use an AC power outlet exclusively for the printer. Do not use the other sockets of the AC power outlet.
- Do not plug the power plug in the auxiliary outlet on a computer.
- Do not use the same AC power outlet for both the printer and any of the following equipment.
 - Copy machine
 - Air conditioner
 - Shredder
 - Equipment that consumes a large amount of electricity
 - Equipment that generates electrical noise
- The maximum power consumption of the printer is 1,140 W or less.
- Electrical noise or a dramatic drop in mains voltage may cause the printer or computer to operate incorrectly or lose data.

Do not install the printer in the following locations, as this may result in damage to the printer.

- A location subject to dramatic changes in temperature or humidity
- A location subject to condensation
- A poorly ventilated location
(If you use the printer for a long time or to perform a large amount of printing in a poorly ventilated room, the ozone or other odors generated by the printer may create an uncomfortable working environment. In addition, chemical particles are dispersed during printing. Therefore, it is important to provide adequate ventilation.)
- A location near equipment that generates magnetic or electromagnetic waves
- A laboratory or location where chemical reactions occur
- A location exposed to salt air, corrosive gases, or toxic gases
- A location, such as on a carpet or mat, that may warp from the weight of the printer or where the printer is liable to sink

Precautions when preparing the toner cartridge

See "[Attention \(Toner Cartridge\)](#)."

Precautions when connecting the power cord

- Do not plug the power plug of the printer into an auxiliary outlet on a computer.
- One AC power outlet should be used exclusively for the printer.
- Do not connect this printer to an uninterruptible power source.
This may cause printer malfunction or breakdown in the event of a power failure.

When turning ON the printer for the first time after the printer installation

- Before turning ON the printer, be sure to insert the paper drawer in the printer.
- Although a sheet of blank paper may be output, this is not an error.

Precautions when installing the paper feeder

- Do not touch the connector (A) on the paper feeder. This may result in damage to the printer or misfeeds.

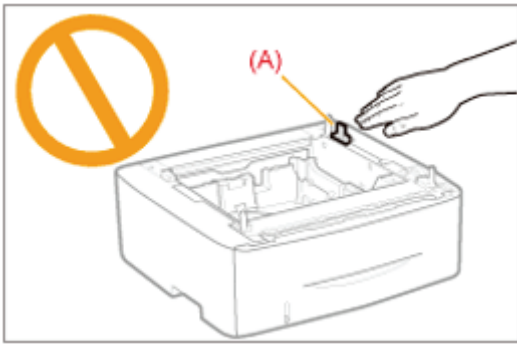

- If you cannot place the printer on the paper feeder properly, lift the printer once, hold it horizontally, and place it again.
If you try to place the printer forcefully without lifting it, the connector and positioning pins may be broken.
- Be sure to turn the printer ON once when loading paper in the paper drawer for the first time after installing the paper feeder.

Precautions when installing/removing ROM

- Be sure not to touch the switches on the main board. If you change the switches, the printer does not operate properly.
- Observe the following precautions when handling ROM to prevent damage from static electricity.
 - Touch a metal object to dissipate static electricity before handling them.
 - When handling ROM, do not touch anything that generates static electricity such as the computer display.
 - Do not touch the main board parts, printed wire, or connectors with your hands.
 - Take ROM out of the protective bag right before it is installed.
- Do not touch the main board parts, printed wire, or connectors with your hands.
- When installing ROM, be careful so that any metal objects such as screws do not touch the main board.
- If any of screws, clips, staples, and so on should drop inside the printer, do not plug the power plug in the AC power outlet and contact your local authorized Canon dealer.
- Do not turn the printer ON without the right cover or slot cover attached. This may result in damage to the printer.

NOTE

About the toner cartridge included with this printer

- The average yield of the included toner cartridges is as follows.
 - The average yield of the included toner cartridge is 2,100 pages.*¹
- ¹ The average yield is on the basis of "ISO/IEC 19752"* when printing A4 size paper with the default print density setting.
- * "ISO/IEC 19752" is the global standard related to "Method for the determination of toner cartridge yield for monochromatic electrophotographic printers and multi-function devices that contain printer components" issued by ISO (International Organization for Standardization).
- For purchasing replacement toner cartridges, see "[Consumables](#)."







Confirming the Supplied Accessories and Checking the Installation Site

04L9-025

Confirming the Supplied Accessories

Make sure that all the supplied accessories are contained in the box before installing the printer.

If an item is missing or damaged, please contact your local authorized Canon dealer.

-  Printer
The following parts are already installed.
 - Paper Drawer
 - Toner Cartridge
-  Power cord
(The form of the supplied power cord may differ from the one in the above illustration.)
-  Quick Setup Guide
-  User Manual CD-ROM
The following are included.
 - e-Manual
 - Getting Started Guide (Arabic, Bulgarian, Croatian, Estonian, Greek, Latvian, Lithuanian, Persian, Romanian, Slovakian, Slovenian, Ukrainian)
-  User Software CD-ROM
The following are included.
 - Printer Driver
 - Printer Driver Installation Guide
-  PS User Software CD-ROM (LBP6680x only)
The following are included.
 - PS Printer Driver
 - Printer Driver Installation Guide

IMPORTANT

Download the printer driver for Macintosh from the Canon Web site

The supplied CD-ROM does not include the printer driver for Macintosh. Download the printer driver for Macintosh that supports this printer from the Canon Web site (<http://www.canon.com/>). If you cannot find the printer driver for Macintosh that supports this printer on the Canon Web site, contact your local authorized Canon dealer.

NOTE

About interface cables

- This printer does not come with an interface cable. Have an appropriate one available for the computer you are using or the connecting method.
- Use a USB cable with the following symbol.



About the Supplied Manuals

The manuals supplied with this printer consist of the following. Read these manuals according to your purpose and make full use of this printer.

Manual Name	Contents
Quick Setup Guide	Explains the procedure for installing the printer.

e-Manual	Explains all the operations of this printer, such as how to use the printer and troubleshooting. (The contents of "Quick Setup Guide" are also included.)
Getting Started Guide	This is the simple manual (PDF format) written in the following languages. – Arabic, Bulgarian, Croatian, Estonian, Greek, Latvian, Lithuanian, Persian, Romanian, Slovakian, Slovenian, Ukrainian

To view the manual in PDF format, Adobe Reader/Adobe Acrobat Reader is required.
If Adobe Reader/Adobe Acrobat Reader is not installed on your system, download it from the Adobe Systems Incorporated Web site.

Checking the Installation Site

In order to use this printer in a safe and trouble-free manner, install the printer in a place that fulfills the following conditions.

Temperature and Humidity Conditions

Temperature range	10 to 30°C (50 to 86°F)
Humidity range	20 to 80% RH (no condensation)

Power Supply Requirements

220 to 240 V (±10%), 50/60 Hz (±2 Hz)

Installation Requirements

- A location with sufficient space
- † Refer to the following dimensions of each part and ensure the installation space.

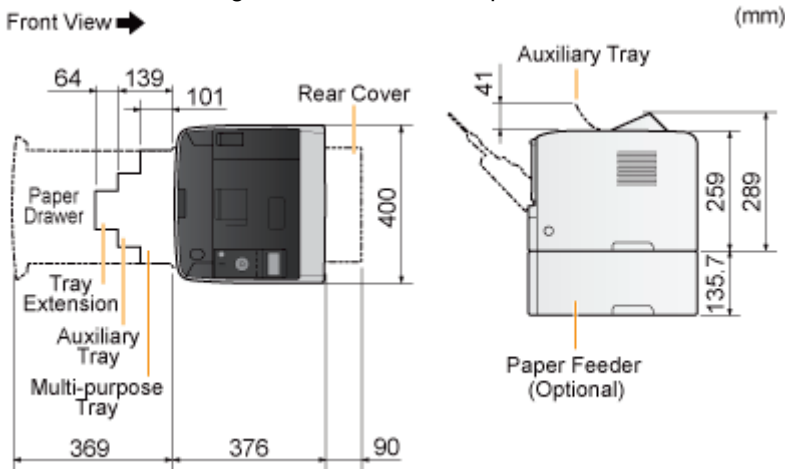

- A location with good ventilation
- A location with a flat, even surface
- A location able to fully support the weight of the printer

Removing the Packing Materials

04L9-026

NOTE

Store the removed packing materials.

They are required when transporting the printer for relocation or maintenance.

About the packing materials

The packing materials may be changed in form or placement, or may be added or removed without notice.

Remove all the orange tape if it is attached to the printer when performing the following procedure.

1

Open the front cover while pressing the open button.

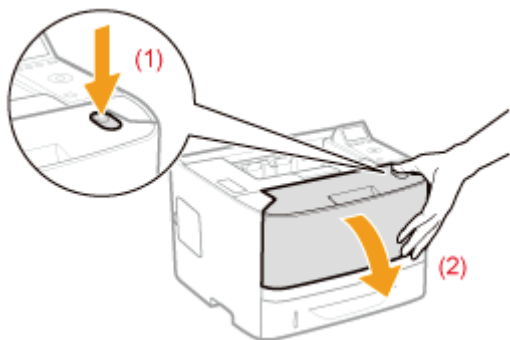

2

Turn over the paper toward you.

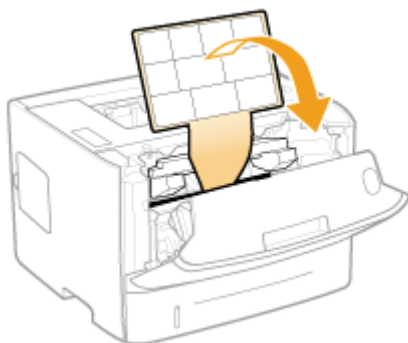

3

Remove the packing material inside the front cover.

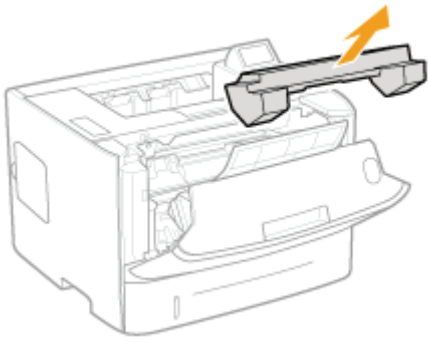

4

Remove the toner cartridge.

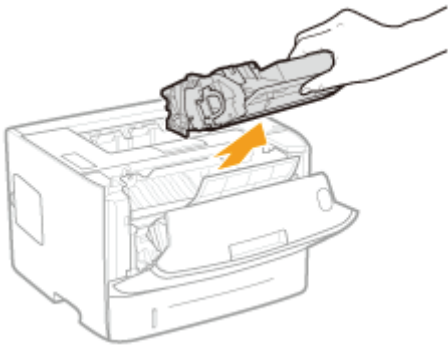

5

Shake the toner cartridge five or six times as shown in the figure to evenly distribute the toner inside the cartridge.

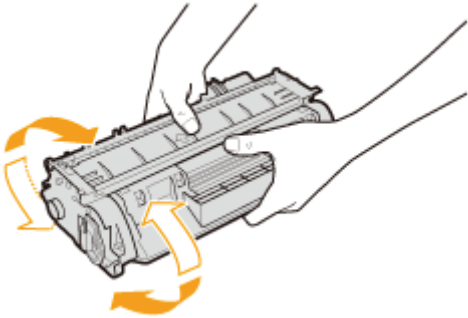

6

Place the toner cartridge on a flat surface.

7

Fold the tab, and then pull out the sealing tape (approx. 48 cm).

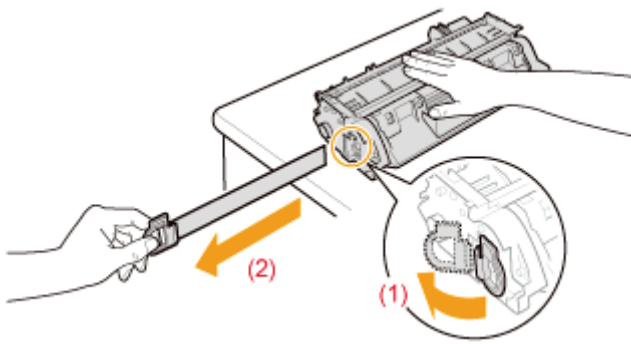

IMPORTANT

Precautions when pulling out the sealing tape

- Do not pull the sealing tape diagonally, upward, or downward. If the tape is severed, this may become difficult to pull out completely.

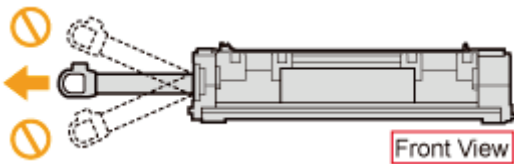

- If the sealing tape stops at midpoint, pull it out of the toner cartridge completely. If any tape remains in the toner cartridge, this may result in poor print quality.
- Dispose of the removed sealing tape according to local regulations.

8

Remove the packing material with paper inside the front cover.

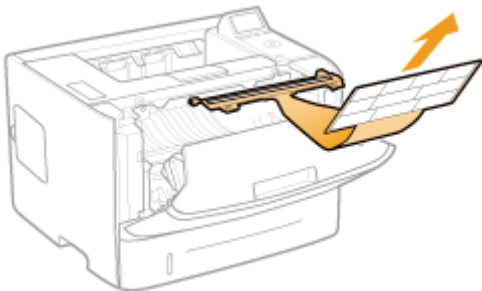

9

Install the toner cartridge.

Push the toner cartridge into the printer firmly until it touches the back of the printer while aligning (A) on both sides of the toner cartridge with the toner cartridge guides inside the printer.

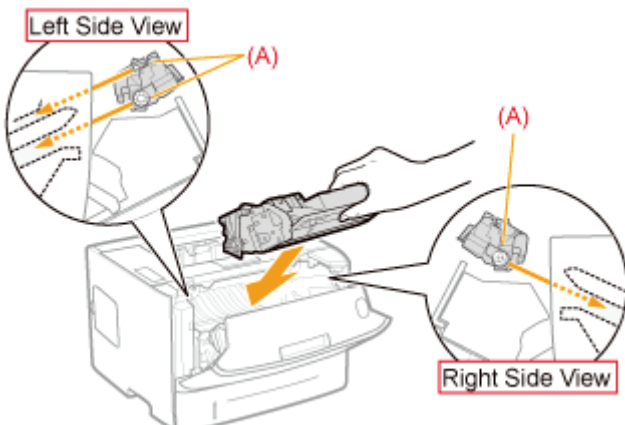

10

Close the front cover.

? If you cannot close the front cover

Make sure that the toner cartridge is installed in the printer properly. Do not try to forcefully close the front cover, as this may damage the printer.

✓ Check !

Checking if the packing materials are removed

Check that the following packing materials are completely removed.



Tape*



Packing material with paper x1

† Dispose of the left packing materials according to local regulations.



Packing material x1



Sealing tape x1

* Make sure that all the orange tape is completely removed.

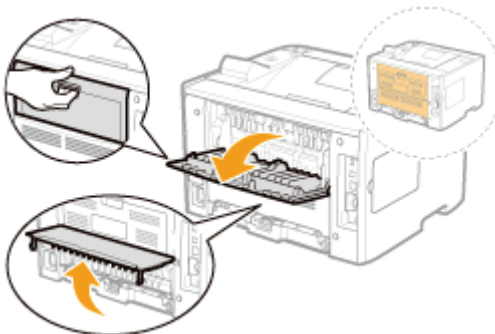
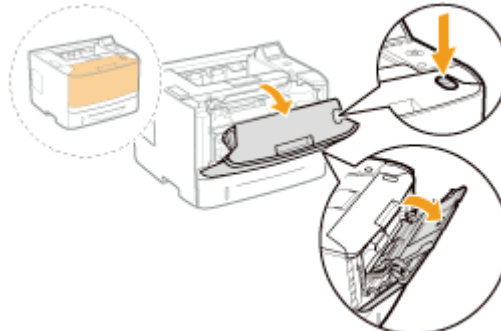
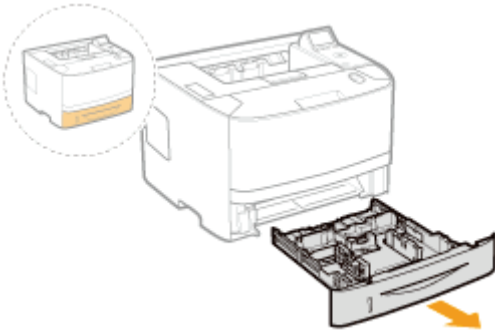

† Close the covers after you finish checking.

☞ Next, perform one of the following procedures.

If you want to use the printer with optional accessories installed

Install the optional accessories before installing the printer.

- ❖ "Installing the Paper Feeder"
- ❖ "Installing ROM"
- ❖ "Installing SD Card"

If you want to use the printer without optional accessories installed

Install the printer.

➤ ["Installing the Printer"](#)

Installing the Paper Feeder

04L9-027

By installing the optional paper feeder in addition to the supplied multi-purpose tray and paper drawer, the printer can feed up to 800 sheets of paper continuously and automatically.

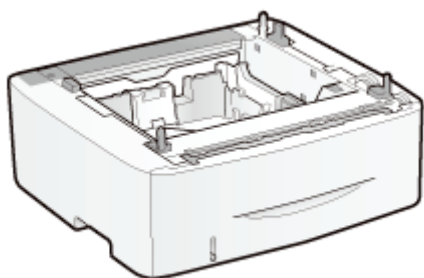

Paper Feeder Unit PF-44

<If the printer is already installed>

- When installing the paper feeder in the printer after installing the printer, move the printer to an appropriate location temporarily.
 - ["Moving the Printer"](#)
- For details on the precautions for when installing the paper feeder, see ["Attention \(Printer Installation\)."](#)

Remove all the orange tape if it is attached to the paper feeder when performing the following procedure.

1

Take the paper feeder out of the box.

2

Pull out the paper drawer of the paper feeder.

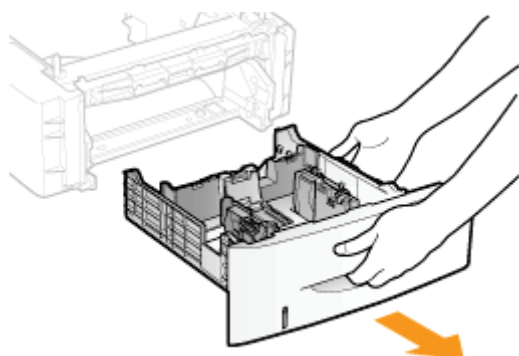

3

Carry the paper feeder to the installation site.

When carrying the paper feeder, hold the lift handles on both sides with both hands.

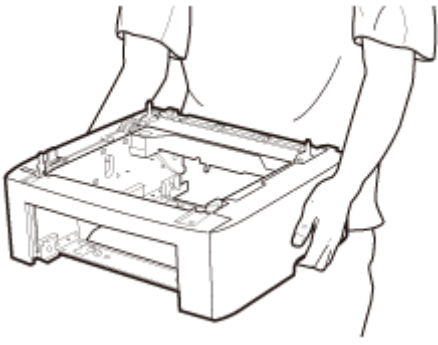

4

Pull out the paper drawer of the printer.

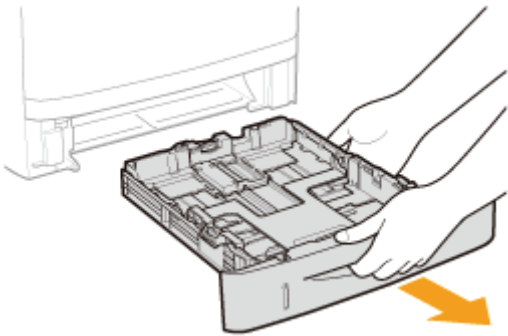

5

Carry the printer unit to the installation site.

After confirming that the covers and trays are closed, carry the printer by holding it by the lift handles from the front side.

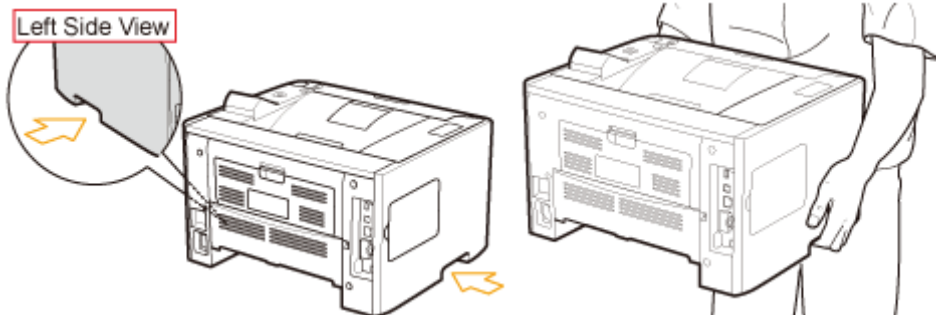

6

Gently place the printer on the paper feeder so that each surface of the printer is flush with the front or side surfaces of the paper feeder.

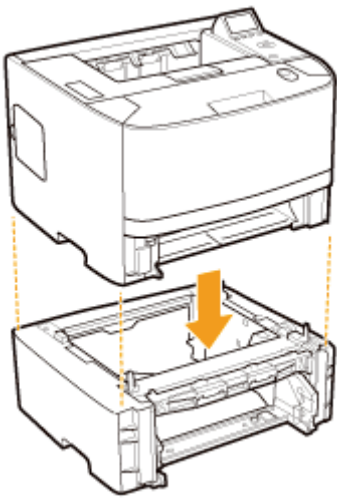

Also, match the positioning pins (A) and connector (B) when placing the printer.

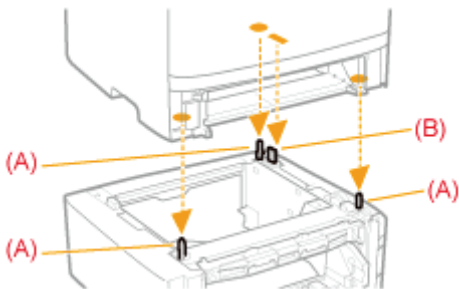

7

Insert the paper drawers in the printer and paper feeder.

Push it in the printer firmly.

Next, perform the following procedures.

- If you want to install the ROM modules, follow the procedure from Step 2 in "Installing ROM."
- If you want to install the SD card, follow the procedure from Step 2 in "Installing SD Card."

If you install the printer and paper feeder at the same time

1	Connect the power cord.	❖ "Connecting the Power Cord"
2	Specifying the printer's initial settings.	❖ "Turning the Power On and Specifying a Language"
	Specifying a type of printer driver.	❖ "Specifying a Type of Printer Driver"
3	Load paper.	❖ "Loading Paper in the Paper Drawer" ❖ "Loading Paper in the Multi-purpose Tray"
4	Connecting to a computer.	❖ "Connecting to a Computer"
5	Install the printer driver.	❖ "For Windows" ❖ "For Macintosh"

6	Register the paper feeder in the printer driver.	➤ "Setting the Paper Feeder Information"
7	Check the printing operation.	Check the operations by Test Page in Windows. ➤ "Basic Operations/Various Information for Windows"

If you install the paper feeder afterward (If you are using the printer already)

1	Connect the cables and cords.	Reconnect the cables and power cords that were removed and restart the printer.
2	Load paper. (Drawer 2*)	➤ "Loading Paper in the Paper Drawer"
3	Register the paper feeder in the printer driver.	➤ "Setting the Paper Feeder Information"
4	Check the printing operation.	Check the operations by Test Page in Windows. ➤ "Basic Operations/Various Information for Windows"

*Paper drawer of the paper feeder

Setting the Paper Feeder Information

After installing the paper feeder, set the paper feeder information.

† The operation method to use with Windows is explained here. If you are a Macintosh user, see the "Online Manual."

1

Open the printer folder.

➤ "Basic Operations/Various Information for Windows"

2

Right-click the icon for the printer, and then select [Printer properties] or [Properties] from the pop-up menu.

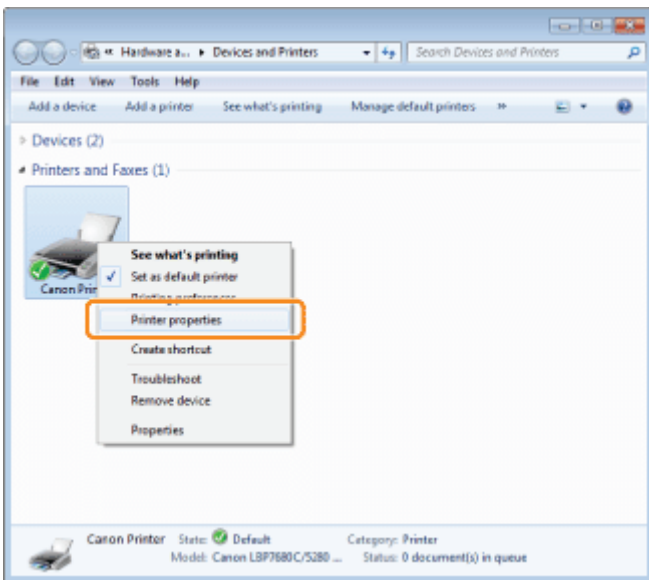

3

Obtain paper feeder information.

- (1) Display the [Device Settings] page.
 - (2) Click [Get Device Status].
- Paper feeder information is obtained automatically.

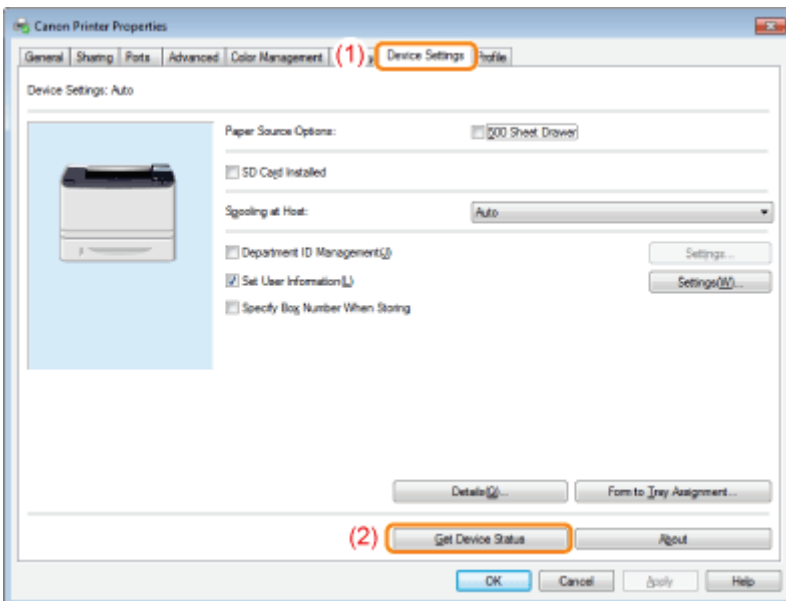

NOTE

When paper feeder information cannot be obtained automatically

Select the check box for [500 Sheet Drawer] under [Paper Source Options].

Installing the Printer

04L9-028

† If you want to use the printer with optional accessories installed, install them before installing the printer.

- "Installing the Paper Feeder"
- "Installing ROM"
- "Installing SD Card"

Carrying the Printer to the Installation Site

1

Pull out the paper drawer.

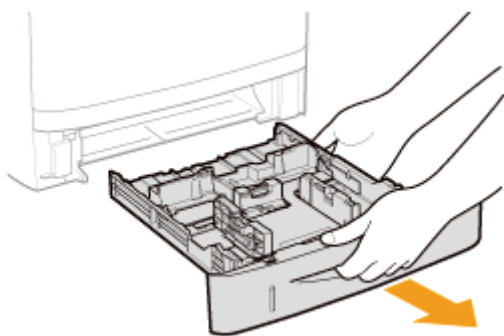

2

Carry the printer unit to the installation site.

After confirming that the covers and trays are closed, carry the printer by holding it by the lift handles from the front side.

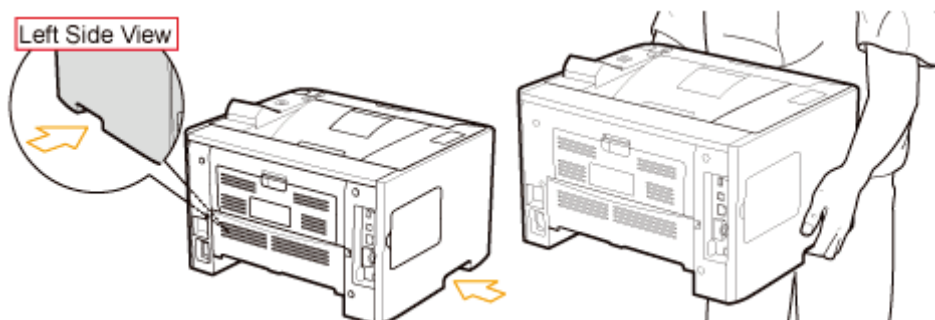

3

Insert the paper drawer in the printer.

Push it in the printer firmly.

Connecting the Power Cord

1

Connect the power cord.

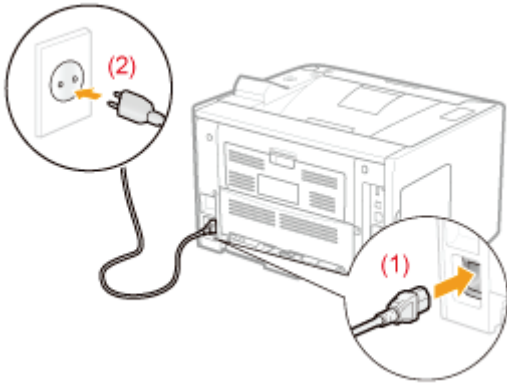

NOTE

The form of the supplied power cord



The form of the supplied power cord may differ from the one in the above illustration.

2

Press the power switch to turn the printer ON.

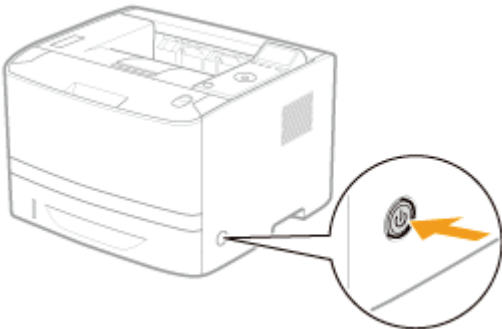
→ The indicators and display on the control panel come on, and the printer initiates a self-diagnostic test on the printer unit and optional accessories.



If no abnormality is found during the self-diagnostic test, the Main Power indicator (green),  (Ready) indicator (green),  (Online) indicator (green) and Paper Source indicator (green) come on, <Ready to print.> appears in the display, and the printer is ready to print.

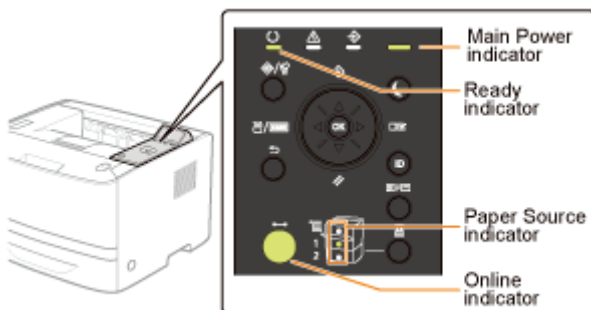

The following information is displayed in the display.

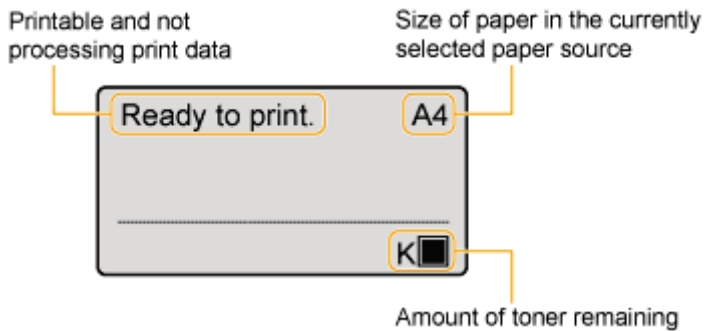

Next, perform the following procedures.

1	Specifying the printer's initial settings	<ul style="list-style-type: none"> ❖ "Turning the Power On and Specifying a Language"
	Specifying a type of printer driver	<ul style="list-style-type: none"> ❖ "Specifying a Type of Printer Driver"
2	Load paper.	<ul style="list-style-type: none"> ❖ "Loading Paper in the Paper Drawer" ❖ "Loading Paper in the Multi-purpose Tray"
3	Connecting to a computer	<ul style="list-style-type: none"> ❖ "Connecting to a Computer"
4	Install the printer driver.	<ul style="list-style-type: none"> ❖ "For Windows" ❖ "For Macintosh"
5	Check the printing operation.	<p>Check the operations by Test Page in Windows.</p> <ul style="list-style-type: none"> ❖ "Basic Operations/Various Information for Windows"

Installing ROM

04L9-029

Insert the ROM in the position shown in the following figure.
After checking the position of the ROM, perform the work.

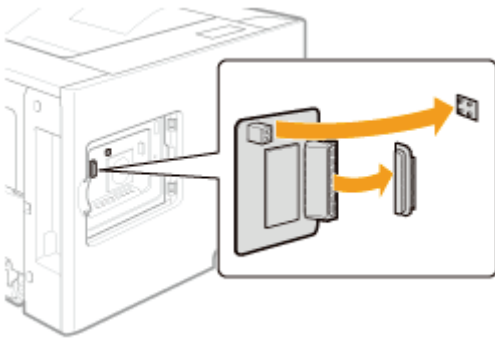

➤ Installing ROM

It explains the procedure for inserting the ROM.
Insert the ROM correctly using the following procedure.

➤ Checking the ROM Installation

It explains the procedure for checking whether the ROM is inserted correctly.
After inserting, perform a check using the following procedure.

➤ Removing ROM

It explains the procedure for removing the ROM.
Use the following procedure when removing the ROM.

NOTE

A Phillips screwdriver is required.

Have a screwdriver ready that matches the size of the screws for the slot cover.

1

Turn the printer OFF, and then disconnect the cables or cords from the printer.

† Shut down the printer before turning it OFF.

For details on the procedure for shutting down the printer, see "[Turning the Printer ON/OFF.](#)"

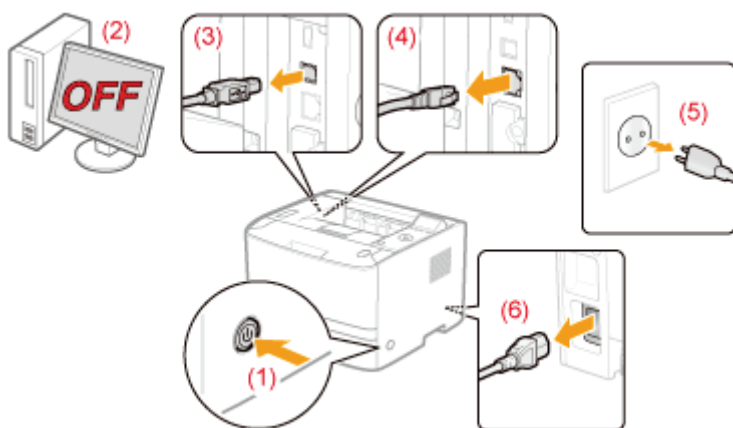

<How to disconnect the cable or cord>

USB cable*	(2) Turn the computer OFF. (3) Disconnect the cable from the printer.
LAN cable*	(4) Disconnect the cable from the printer.
Power cord	(5) Disconnect the power plug from the AC power outlet. (6) Disconnect the cord from the printer.

* Whether the cable is connected or not varies depending on your environment.

2

Remove the left cover.

(1) While holding the tab (A), open the cover a little.

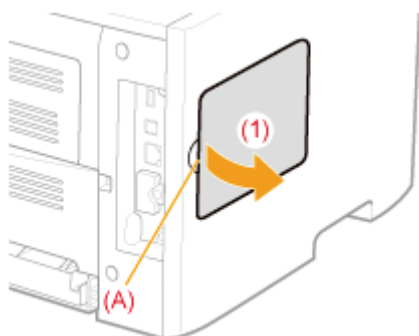

(2) Remove the cover in the direction of the arrow.

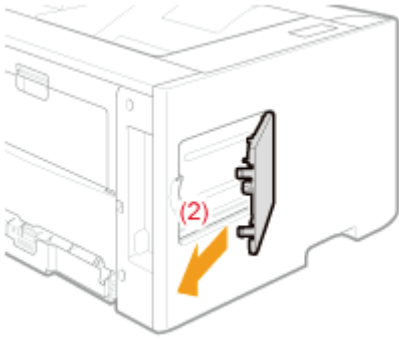

3

Remove the slot cover.

(1) Remove the screw.

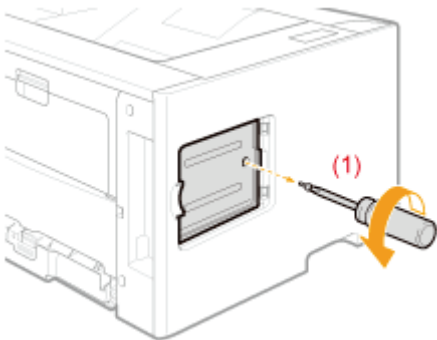

(2) Open the slot cover.

(3) Remove the cover in the direction of the arrow.

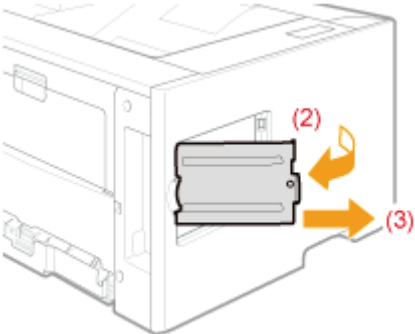

NOTE

About the location for installing ROM

Confirm the installation location and its orientation before installing the ROM module.

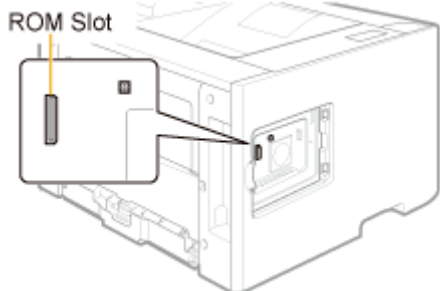

4

Install ROM.

Push the ROM module into the printer firmly while aligning the module with the two connectors.

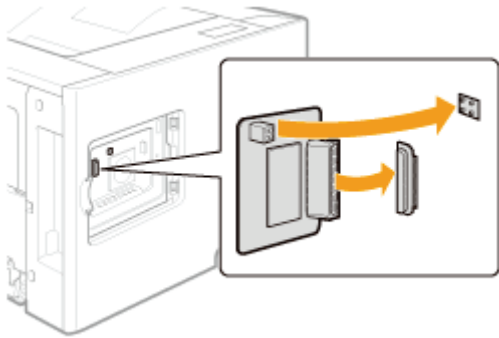

5

Attach the slot cover.

- (1) Attach the slot cover.
- (2) Close the cover.

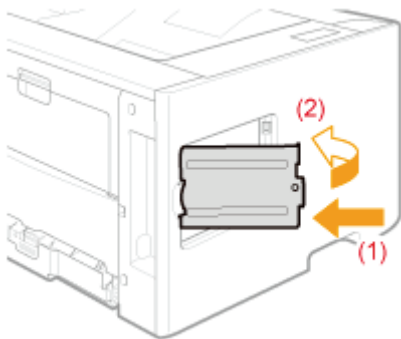

6

Attach and fasten the screw.

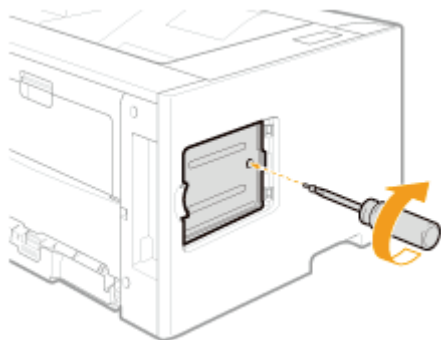

7

Attach the left cover.

- (1) Attach the left cover.
- (2) Close the cover.

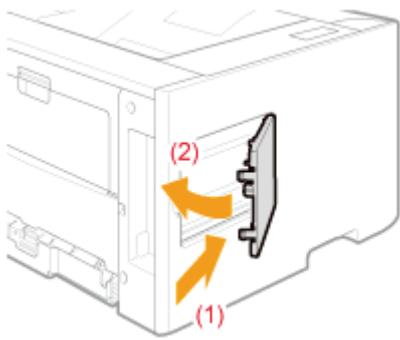

Next, perform the following procedures. (If you want to install the SD card, follow the procedure from Step 2 in "Installing SD Card".)

If you install the printer and ROM at the same time

1	Connect the power cord.	<ul style="list-style-type: none"> ❖ "Connecting the Power Cord"
2	Specifying the printer's initial settings.	<ul style="list-style-type: none"> ❖ "Turning the Power On and Specifying a Language"
	Specifying a type of printer driver.	<ul style="list-style-type: none"> ❖ "Specifying a Type of Printer Driver"
3	Load paper.	<ul style="list-style-type: none"> ❖ "Loading Paper in the Paper Drawer" ❖ "Loading Paper in the Multi-purpose Tray"
4	Connecting to a computer.	<ul style="list-style-type: none"> ❖ "Connecting to a Computer"
5	Install the printer driver.	<ul style="list-style-type: none"> ❖ "For Windows" ❖ "For Macintosh"
6	Check the printing operation.	<p>Check the operations by Test Page in Windows.</p> <ul style="list-style-type: none"> ❖ "Basic Operations/Various Information for Windows"
7	Check the ROM installation.	<ul style="list-style-type: none"> ❖ "Checking the ROM Installation"
8	Specify the settings for the ROM module as needed.	<p>Specify the settings in the menu functions.</p> <ul style="list-style-type: none"> ❖ "[Setup] Menu ([PS] Options)" <p>For details on the settings for the bar code fonts, see "Bar Code Printing Guide" included in the User Manual CD-ROM.</p>

If you installed ROM afterward (If you are using the printer already)

1	Connect the cables and cords.	Connect the removed cables and cords again.
2	Check the ROM installation.	<ul style="list-style-type: none"> ❖ "Checking the ROM Installation"
3	Specify the settings for the ROM module	<p>Specify the settings in the menu functions.</p> <ul style="list-style-type: none"> ❖ "[Setup] Menu ([PS] Options)"

as needed.

For details on the settings for the bar code fonts, see "Bar Code Printing Guide" included in the User Manual CD-ROM.

Checking the ROM Installation

04L9-02C

After installing a ROM module, print Configuration Page to check if the module is installed properly.

NOTE

Load A4 size paper.

Configuration Page is designed to be printed on A4 size paper.
Be sure to load A4 size paper when printing the Configuration Page.



1

Load A4 size paper in the multi-purpose tray or paper drawer.

➤ "Paper Loading and Output"

2

Make sure that the printer is online.

If the printer is not online, press [] ( : Online).

3

Press [] ( : Utility).

4

Select [Configuration Page] using [▲] and [▼], and then press [OK].

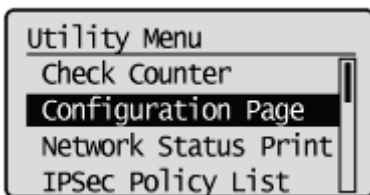

5

Select [Yes] using [▼], and then press [OK] to print Configuration Page.

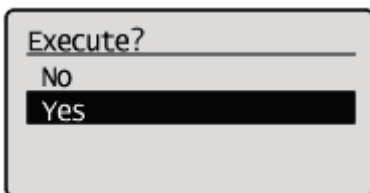

NOTE

How to check the installation

- PS ROM

Confirm that [PS] is displayed in [Controller].

- Bar DIMM

Confirm that [BarDIMM] is displayed in [PCL].

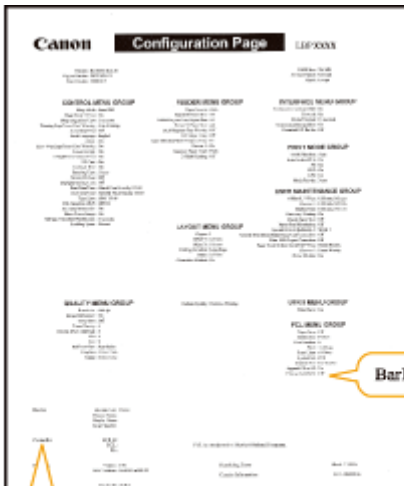

Controller UFR II: Ver.XX.XXX/XX.XXX
PCL: Ver.XX.XX.XXX
PS: Ver.XXXX.XXX

→ If [PS] or [BarDIMM] is not displayed, see "[Removing ROM](#)," remove the ROM module, and then try to install it again.

† This is a sample of Configuration Page. The contents may differ from the Configuration Page printed by your printer.

Removing ROM

04L9-02E

 **NOTE**

How to remove the cover

For details on how to remove the slot cover, see "[Installing ROM.](#)"

Holding the edges of the ROM module, and then pull it out.

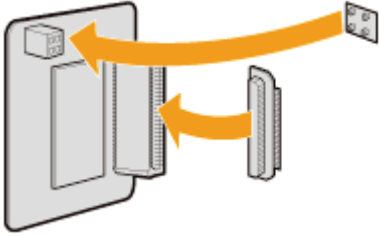

Installing SD Card (LBP6680x Only)

04L9-02F

Insert the SD card in the position shown in the following figure.
After checking the position of the card, perform the work.

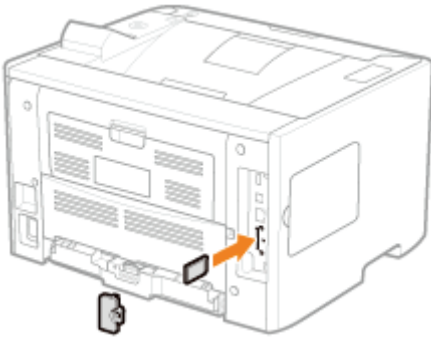

➤ Installing SD Card

It explains the procedure for inserting the SD card.
Insert the SD card correctly using the following procedure.

➤ Checking the SD Card Installation

It explains the procedure for checking whether the SD card is inserted correctly.
After inserting, perform a check using the following procedure.

➤ Removing SD Card

It explains the procedure for removing the SD card.
Use the following procedure when removing the SD card.

Installing SD Card

04L9-02H

SD card is installed in the main board of the printer unit using the following procedure.

IMPORTANT

When using the "Encrypted Secured Print" function whose security is reinforced for data communication and stored data

You need to install "Encrypted Secured Print Driver Add-in."

For details on the installation procedure, see "Readme.txt" in the supplied CD-ROM.

† We recommend that an encrypted secured print be used when printing secured print jobs.

Before installing SD card

If the SD card is write-protected, release the protection, and then insert the card.

NOTE

A Phillips screwdriver is required.

Have a screwdriver ready that matches the size of the screws for the slot cover.

1

Turn the printer OFF, and then disconnect the cables or cords from the printer.

† Shut down the printer before turning it OFF.

For details on the procedure for shutting down the printer, see "[Turning the Printer ON/OFF.](#)"

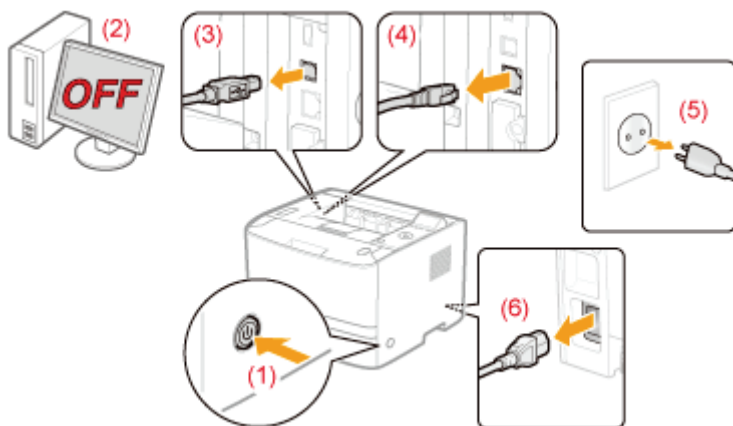

<How to disconnect the cable or cord>

USB cable*	(2) Turn the computer OFF. (3) Disconnect the cable from the printer.
LAN cable*	(4) Disconnect the cable from the printer.
Power cord	(5) Disconnect the power plug from the AC power outlet. (6) Disconnect the cord from the printer.

* Whether the cable is connected or not varies depending on your environment.

2

Remove the slot cover.

(1) Remove the screw.

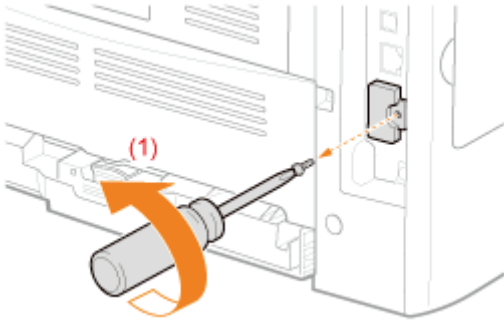

(2) Remove the slot cover.

(3) Remove the cover in the direction of the arrow.

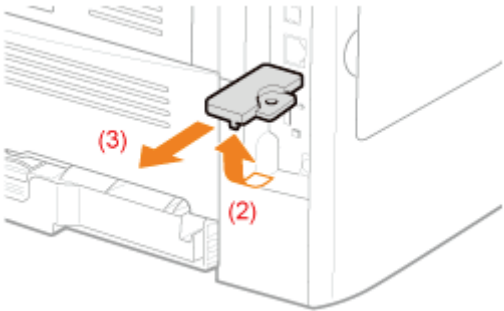

3

Install SD card.

Install the SD card in the SD card slot until it clicks.

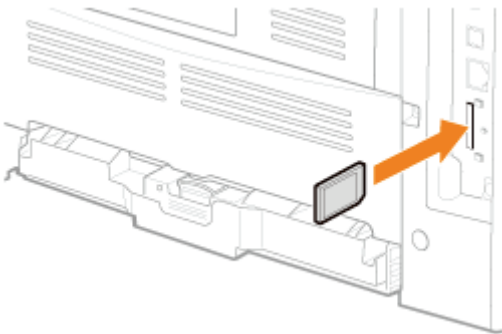

4

Attach the slot cover.

(1) Attach the slot cover.

(2) Close the cover.

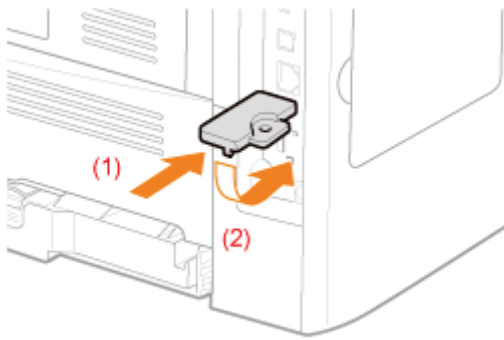

(3) Attach and fasten the screw.

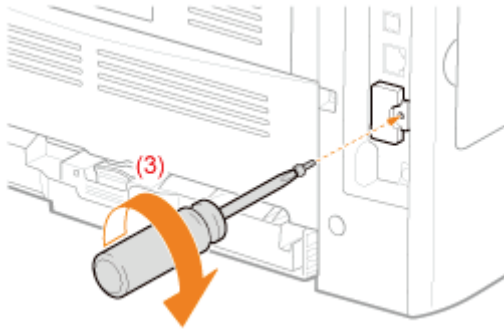

5

Hard reset or restart the printer.

If <Formatting SD Card?> appears in the display after the printer starts, the SD card is being formatted. Wait for a moment until the format is completed.

IMPORTANT

If <Formatting SD Card?> does not appear in the display

Perform [Format] in [SD Card Maintenance] in the common Setup menu.

➤ "[Setup] Menu ([User Maintenance] Options)"

6

Connect all the interface cables.

NOTE

Setting after the SD card is installed

Perform the following procedure after the SD card is installed.

(1) Display the [Device Settings] sheet in the printer driver.

For details on the procedure for displaying the sheet, see "[Setting the Printer Options.](#)"

(2) Click [Get Device Status].

If you cannot obtain the status of the optional accessories automatically, select the [SD Card Installed] check box.

For details on the procedure for Macintosh, see "[Setting the Printer Options.](#)"

 Next, perform the following procedures.

If you install the printer and SD card at the same time

1	Connect the power cord.	<ul style="list-style-type: none"> ❖ "Connecting the Power Cord"
2	Specifying the printer's initial settings.	<ul style="list-style-type: none"> ❖ "Turning the Power On and Specifying a Language"
	Specifying a type of printer driver.	<ul style="list-style-type: none"> ❖ "Specifying a Type of Printer Driver"
3	Load paper.	<ul style="list-style-type: none"> ❖ "Loading Paper in the Paper Drawer" ❖ "Loading Paper in the Multi-purpose Tray"
4	Connecting to a computer.	<ul style="list-style-type: none"> ❖ "Connecting to a Computer"
5	Install the printer driver.	<ul style="list-style-type: none"> ❖ "For Windows" ❖ "For Macintosh"
6	Check the printing operation.	<p>Check the operations by Test Page in Windows.</p> <ul style="list-style-type: none"> ❖ "Basic Operations/Various Information for Windows"
7	Checking the ROM Installation. (Only when installing ROM)	<ul style="list-style-type: none"> ❖ "Checking the ROM Installation"
	Checking the SD Card Installation.	<ul style="list-style-type: none"> ❖ "Checking the SD Card Installation"
8	Specify the settings for the ROM module as needed.	<p>Specify the settings in the menu functions.</p> <ul style="list-style-type: none"> ❖ "[Setup] Menu ([PS] Options)" <p>For details on the settings for the bar code fonts, see "Bar Code Printing Guide" included in the User Manual CD-ROM.</p>

If you installed SD card afterward (If you are using the printer already)

1	Connect the cables and cords.	Connect the removed cables and cords again.
2	Checking the ROM Installation. (Only when installing ROM)	<ul style="list-style-type: none"> ❖ "Checking the ROM Installation"
	Checking the SD Card Installation.	<ul style="list-style-type: none"> ❖ "Checking the SD Card Installation"
3	Specify the settings for the ROM module as needed.	<p>Specify the settings in the menu functions.</p> <ul style="list-style-type: none"> ❖ "[Setup] Menu ([PS] Options)" <p>For details on the settings for the bar code fonts, see "Bar Code Printing Guide" included in the User Manual CD-ROM.</p>

Checking the SD Card Installation

04L9-02J

After installing an SD card, print Configuration Page to check if the module is installed properly.

NOTE

Load A4 size paper.

Configuration Page is designed to be printed on A4 size paper.
Be sure to load A4 size paper when printing the Configuration Page.



1

Load A4 size paper in the multi-purpose tray or paper drawer.

➤ "Paper Loading and Output"

2

Make sure that the printer is online.

If the printer is not online, press [] ( : Online).

3

Press [] ( : Utility).

4

Select [Configuration Page] using [▲] and [▼], and then press [OK].

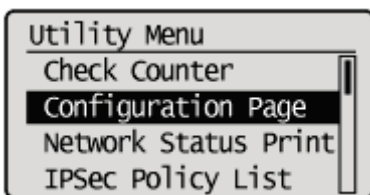

5

Select [Yes] using [▼], and then press [OK] to print Configuration Page.

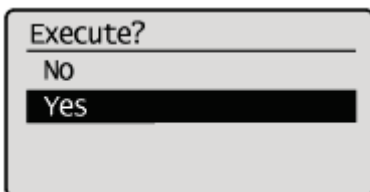

NOTE



How to check the installation

Check to make sure that [SD Card] under the [Control Menu] is set to [On].



→ If [SD Card] is not displayed, see "[Removing SD Card](#)," remove the SD card, and then try to install it again.

→ If the [SD Card] is [Off], set it to [On] using the following procedure.

- (1) Press [] ( : Settings).
- (2) Select [Control Menu] using [▲] and [▼], and then press [OK].
- (3) Select [SD Card] using [▲] and [▼], and then press [OK].
- (4) Select [On] using [▲] and [▼], and then press [OK].
- (5) Hard reset or restart the printer.

→ Check that the SD card is not write-protected. If the card is write-protected, release the protection, and then insert the card.

† The above figure is a sample of Configuration Page. The contents may differ from the Configuration Page printed by your printer.

Removing SD Card

04L9-02K

NOTE

How to remove the cover

For details on how to remove the slot cover, see "[Installing SD Card.](#)"

1

Insert the SD card until it clicks, and then release your hand.

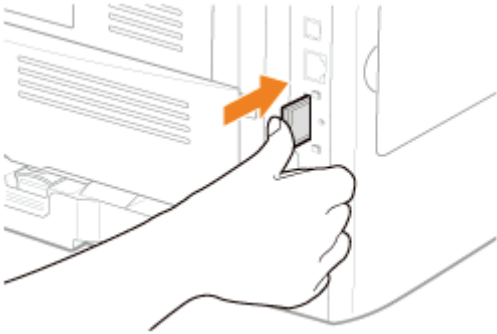

2

Remove the SD card.

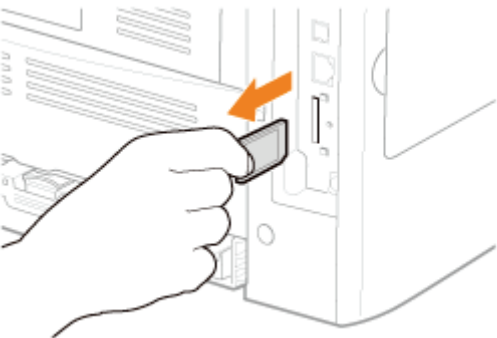

Specifying the Printer's Initial Settings

04L9-02L

↳ Turning the Power On and Specifying a Language

↳ Specifying a Type of Printer Driver

Turning the Power On and Specifying a Language

04L9-02R

When the printer is turned ON, the initial setting screen appears.

Specify the setting using the following procedure.

NOTE

About the initial setting screen



The initial setting screen is displayed only when the printer is turned ON for the first time.

1

Press the power switch to turn the printer ON.

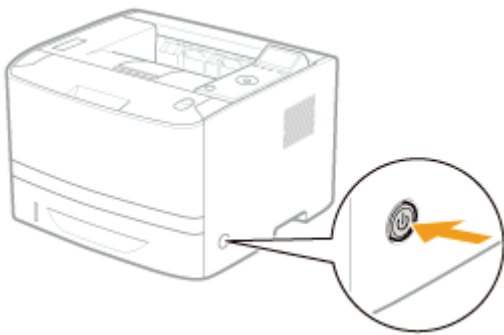
→ The indicators and display on the control panel come on, and the printer initiates a self-diagnostic test on the printer unit and optional accessories.



If no abnormality is found during the self-diagnostic test, the Main Power indicator (green),  (Ready) indicator (green),  (Online) indicator (green) and Paper Source indicator (green) come on, <Ready to print.> appears in the display, and the printer is ready to print.

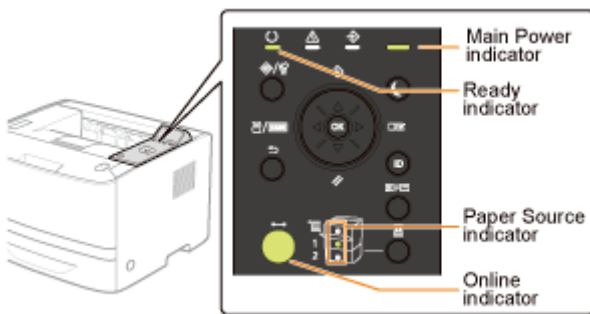

IMPORTANT

Do not turn the printer ON immediately after turning it OFF.

If you want to cycle the power of the printer, wait at least 10 seconds before turning it ON again.

If the printer does not operate properly

➤ ["Troubleshooting"](#)

If an error message appears in the display on the control panel

➤ ["A Message Appears in the Control Panel"](#)

When turning ON the printer for the first time after installing the printer and paper feeder

Do not load paper in the paper drawer.

➤ ["Printer Installation"](#)

Precautions when turning OFF the printer

If you turn the printer OFF, all print data remaining in the printer memory will be erased.

Power consumption when the power is OFF

Even if the printer is turned OFF, power is still consumed slightly while the power plug is inserted in the AC power outlet. To stop the power consumption completely, unplug the power plug from the AC power outlet.

2

Select a display language using [▲] and [▼], and then press [OK].

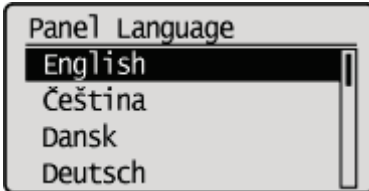

3

Specify a date, and then press [OK].

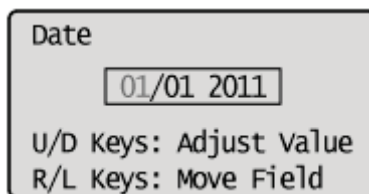

4

Specify time, and then press [OK].

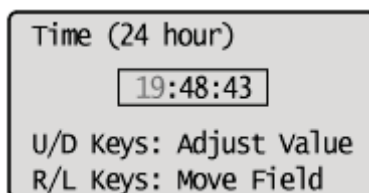

→ The following screen appears, and the settings are completed.

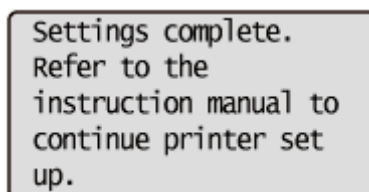

NOTE

About the clock in this printer

The clock in the printer should be accurate within ± 60 seconds per month. Adjust the clock periodically.

When setting time zones and daylight savings time

See "[Setup] Menu ([Control Menu] Options)" under "Setting Items" in "Managing the Printer."

Specifying a Type of Printer Driver

04L9-025

When printing from a computer by USB connection, specify which of the following printer drivers is used.

- UFR II
- UFR II XPS (LBP6680x only)
- PCL5e
- PCL6
- PS3
- XPS (Direct) (LBP6680x only)

You can select the type of printer driver to be installed at the time.

IMPORTANT

When installing the printer driver manually

Be sure to match the setting of this item and the type of the printer driver to be installed. You cannot use printer drivers of a different type.

1

Press [] ( : Settings).

2

Select [Control Menu] using [▲] and [▼], and then press [OK].

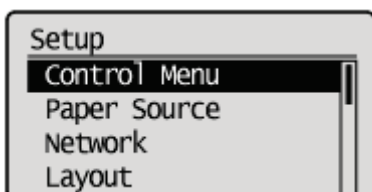

3

Select [Select PDL (PnP)] using [▲] and [▼], and then press [OK].

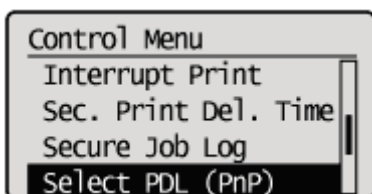

When the message is displayed, press [OK] to continue.

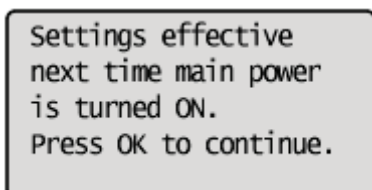

4

Select the printer driver to be used using [▲] and [▼], and then press [OK].

→ The setting value is changed.

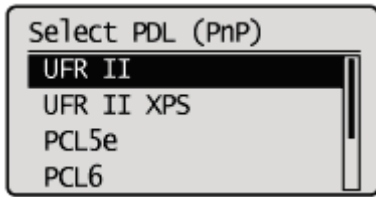

† Cycle the power of the printer or perform a hard reset to make the setting effective.

When Connecting Using a USB Cable

Before connecting the printer to a computer, see "Important Safety Instructions."

IMPORTANT

Do not plug or unplug the USB cable while the printer or computer is ON.

This may cause the printer to malfunction.

About unidirectional communication equipment

The printer performs bi-directional communication. Operation of the printer when connected via unidirectional communication equipment was not tested, and as a result, Canon cannot guarantee printer operation if the printer is connected using unidirectional print servers, USB hubs or switching devices.

NOTE

About the USB interface

The appropriate USB interface varies depending on the operating system of the connected computer as follows. For more details, contact your local authorized Canon dealer.

Windows 2000, XP, Vista, 7, Server 2003, and Server 2008:	Hi-Speed USB/USB
Mac OS X (10.3.2 or earlier):	USB
Mac OS X (10.3.3 or later):	Hi-Speed USB/USB

About the interface cable

- This printer does not come with an interface cable. Have an appropriate one available for the computer you are using or the connecting method.
- Use a USB cable with the following symbol.



1

Make sure that the printer and computer are OFF.

Check if the Main Power indicator on the control panel is turned off.

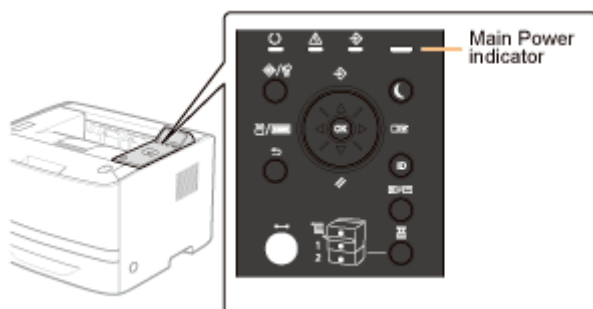

2

Connect the USB cable.

- Flat end (A): Connects to a USB port on your computer.
- Square end (B): Connects to the USB connector on this printer.

† Do not turn the printer ON at this stage even if you want to install the printer driver.

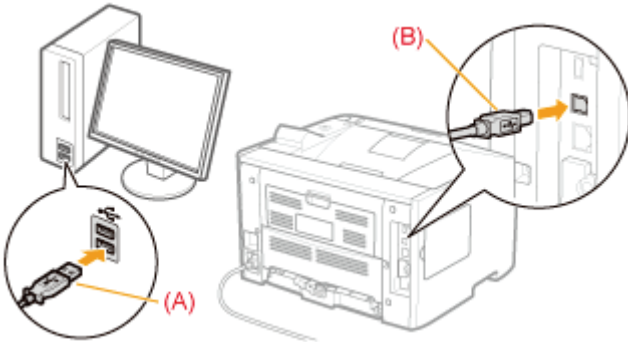

When Connecting with a LAN Cable

IMPORTANT

If more than one devices are connected to an AppleTalk network

Turn on each device at an interval of ten seconds or longer.

NOTE

About the network environment

This printer supports 10BASE-T, 100BASE-TX and 1000BASE-T connections.

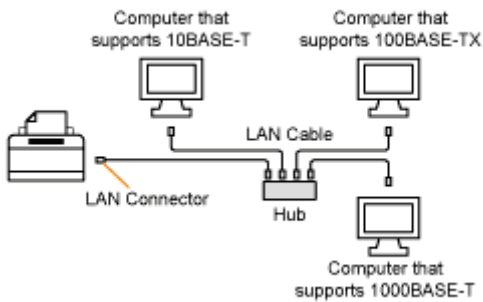

About the LAN cable

- This printer does not come with a LAN cable or a hub. Have cables or a hub ready as needed. Use a Category 5 or higher twisted pair cable for the LAN.
- If you want to connect the printer to a 100BASE-TX or 1000BASE-T Ethernet network, all the devices to be connected to the LAN (hub, LAN cable, and network board for computer) must support 100BASE-TX or 1000BASE-T. For more details, contact your local authorized Canon dealer.

When the printer is connected to a network

- Check the MAC address of the print server with Network Status Print, and then configure the network operating system (UNIX, etc.) and print server.
- ["Checking the Printer Settings"](#)
- ["Configuring the Network Settings \(Sharing the Printer\)"](#)

1

Connect the LAN cable.

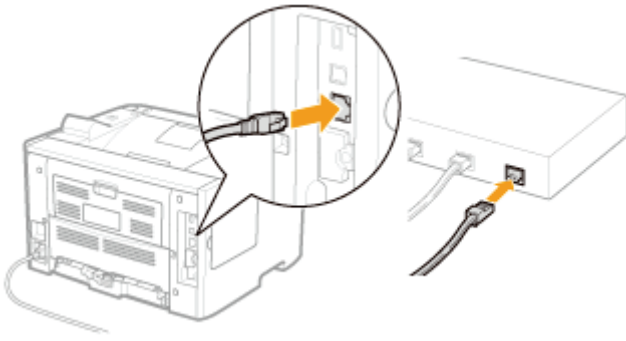

2

Turn the printer ON.

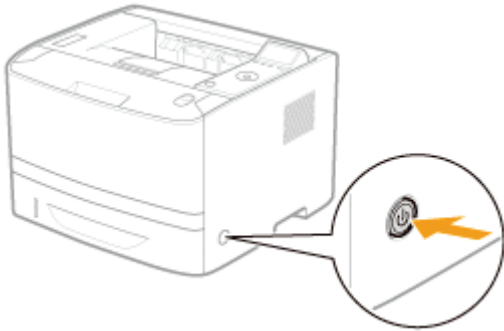

3

Make sure that the LNK indicator (A) on the network interface is on.

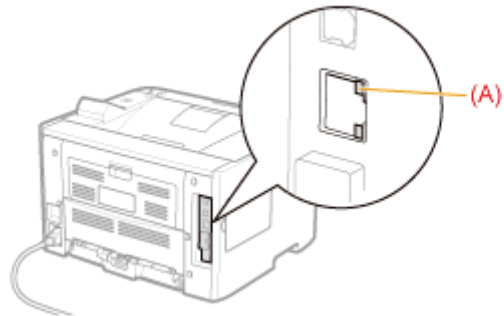

? When the LNK indicator is off

➤ "All the Indicators on the Network Interface Are Off"

Installing the Software

04L9-02W

▣ For Windows

- ▣ Selecting the Appropriate Printer Driver
- ▣ Installation
- ▣ Other Software Programs

▣ For Macintosh

- ▣ Installation
-

For Windows

04L9-02X

To print from a computer, you must install the printer driver and set up the printer configuration using the printer driver.

- ❖ [Selecting the Appropriate Printer Driver](#)
 - ❖ [Installation](#)
 - ❖ [Other Software Programs](#)
-

Selecting the Appropriate Printer Driver

04L9-02Y

The printer driver is installed from a User Software CD-ROM.

Content of Each CD-ROM:

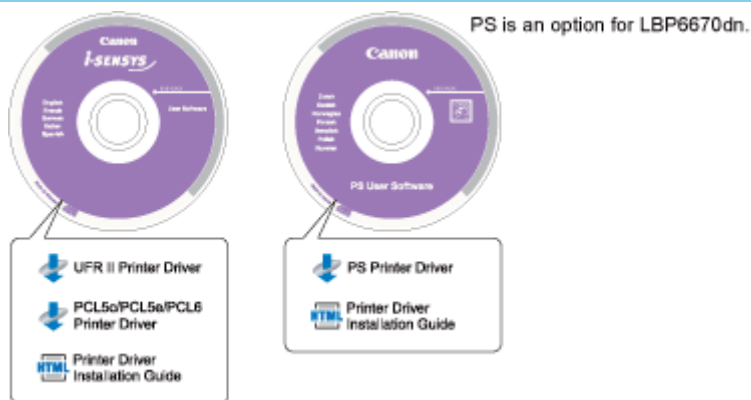

Features of the Printer Driver

- **UFR II Printer Driver:**

Using the UFR II printer driver, the various data processing tasks conventionally executed within the printer are appropriately divided between the host PC and the printer to greatly reduce the overall printing time.

The workload can be delegated to match the output data, thus realizing a significant increase in speed through optimization.

- **PCL Printer Driver:**

The PCL5c, PCL5e, and PCL6 printer drivers can be used with most kinds of business application software.

The PCL5c printer driver is for color printers, the PCL5e printer driver is for black-and-white printers, and the PCL6 printer driver is for both color and black-and-white printers. PCL6 is an advanced version of PCL5c and PCL5e, and offers superior printing quality and speed.

The PCL5e printer driver is provided as standard with black-and-white printers.

- **PS Printer Driver:**

The PS printer driver converts print data from applications into data for use with PS printers, and sends it to the printer.

As well as converting print data, it can also enable you to configure settings relating to finishing and detailed settings such as color adjustment, and provides an appropriate print environment for desktop publishing and publishing on demand.

IMPORTANT

To use PS printer drivers in LBP6670dn

In order to use PS printer drivers, it is necessary to install the optional PS ROM.

From the menu screen of the User Software CD-ROM, you can install the printer driver.

For details about the installation procedure, refer to the "Printer Driver Installation Guide." To view the guide, click [Display Manuals] from the CD-ROM menu before you start the installation.

CD-ROM Menu:

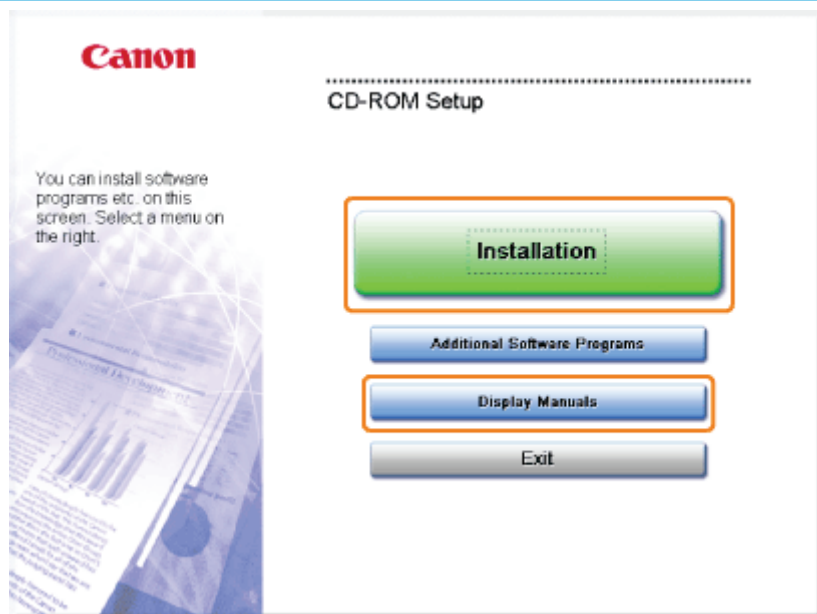

- [Installation]: Click this button to install the printer driver.
- [Display Manuals]: Click this button first to view the Printer Driver Installation Guide. You cannot view the Printer Driver Installation Guide after installation has started.

Other Software Programs

04L9-031

The following software programs are included on the User Software CD-ROM. Available software programs vary depending on the system configuration and CD-ROM.

NetSpot Device Installer

Use this software to specify the initial settings for various devices connected to a network from your computer. For information on installing the software, see the Readme file located in the CD-ROM.

For Macintosh

04L9-032

To print from a computer, you must install the printer driver and set up the printer configuration using the printer driver.

➤ [Installation](#)

Installation

04L9-033

For details about the installation procedure, refer to the appropriate Mac driver guide.

Starting Installation:

Double-click the installation icon in the installer set folder to start the installation.

Viewing the Driver Guide:

Double-click the manual icon in the installation set folder to view the driver guide.

▣ Usable Paper

- ▣ Precautions for Paper
- ▣ Printable Area

▣ Paper Loading and Output

- ▣ Loading Paper in the Paper Drawer
- ▣ Loading Custom Size Paper
- ▣ Loading Paper in the Multi-purpose Tray
- ▣ Registering the Paper Size
- ▣ Configuring the Printer Driver and Printing

▣ Turning the Printer ON/OFF

▣ Online and Offline

▣ Canceling a Job

- ▣ Operations from the Computer
- ▣ Cancelling from the Printer Control Panel
- ▣ Outputting Data (Forced Output)
- ▣ Canceling the Process Currently Being Performed (Soft Reset)
- ▣ Canceling All the Jobs (Hard Reset)

▣ Checking the Printer Status

Usable Paper

04L9-035

The following shows the paper sizes that can be used with this printer.

○ : Available — : Unavailable

Paper Type	Setting for [Paper Type] ^{*1}	Paper Size	Paper Source			2-sided Printing ^{*2}
			Multi-purpose Tray	Drawer 1	Drawer 2 (optional)	
Plain paper ^{*3} (60 to 90 g/m ²)	[Plain] (Default) [Plain L] ^{*4}	A4	○	○	○	○
		B5	○	○	○	—
		A5	○	○	○	—
		A6	○	○	○	—
		Legal	○	○	○	○
		Letter	○	○	○	○
		Executive	○	○	○	—
		Statement	○	—	—	—
		16K	○	○	○	—
Custom size paper	○ ^{*5}	○ ^{*6}	○ ^{*6}	—		
Heavy paper (91 to 150 g/m ²)	[Heavy 1]	A4	○	○ ^{*7}	○ ^{*7}	○ ^{*7}
		B5	○	○ ^{*7}	○ ^{*7}	—
		A5	○	○ ^{*7}	○ ^{*7}	—
		A6	○	○ ^{*7}	○ ^{*7}	—
		Legal	○	○ ^{*7}	○ ^{*7}	○ ^{*7}
		Letter	○	○ ^{*7}	○ ^{*7}	○ ^{*7}
		Executive	○	○ ^{*7}	○ ^{*7}	—
		Statement	○	—	—	—
		16K	○	○	○	—
		Custom size paper	○ ^{*5}	○ ^{*6 *7}	○ ^{*6 *7}	—
Heavy paper (151 to 163 g/m ²)	[Heavy 2]	A4	○	—	—	—
		B5	○	—	—	—
		A5	○	—	—	—
		A6	○	—	—	—
		Legal	○	—	—	—
			○	—	—	—

		Letter				
		Executive	○	—	—	—
		Statement	○	—	—	—
		16K	○	—	—	—
		Custom size paper	○ ^{*5}	—	—	—
Transparency	[Transparency]	A4	○	—	—	—
		Letter	○	—	—	—
Label	[Labels]	A4	○	—	—	—
		B5	○	—	—	—
		A5	○	—	—	—
		A6	○	—	—	—
		Legal	○	—	—	—
		Letter	○	—	—	—
		Executive	○	—	—	—
		Statement	○	—	—	—
		16K	○	—	—	—
		Custom size paper	○ ^{*5}	—	—	—
Index Card	[Envelope]	Index Card	○	—	—	—
Envelope	[Envelope]	Envelope Monarch	○	—	—	—
		Envelope No.10	○	—	—	—
		Envelope DL	○	—	—	—
		Envelope ISO-C5	○	—	—	—
		Envelope ISO-B5	○	—	—	—

*1 The setting is located in the [Paper Source] sheet in the printer driver. If you print from DOS, UNIX, or other operating system, specify a paper type in [Default Paper Type] in the control panel.

*2 2-sided printing supports paper with a weight of 60 to 120 g/m²

*3 Recycled paper can be also used.

*4 If the printed paper curls (the printed side curls outward) when printed with [Plain] selected, select [Plain L].

*5 You can load custom size paper that is 76.2 to 215.9 mm wide and 127.0 to 355.6 mm long. (If you are using the UFR II printer driver, you can load custom size paper that is 127.0 to 215.9 mm wide and 127.0 to 215.9 mm long in landscape orientation.)

*6 You can load custom size paper that is 105.0 to 215.9 mm wide and 148.0 to 355.6 mm long. (If you are using the UFR II printer driver, you can load custom size paper that is 148.0 to 215.9 mm wide and 148.0 to 215.9 mm long in landscape orientation.)

*7 You can load 91 to 120 g/m² heavy paper.

IMPORTANT

About print speed

- The print speed may slow depending on the paper settings for the size, type, orientation, and number of copies.
- When continuously printing paper whose length is 269.3 mm or less, the print speed may slow gradually.
- When continuously printing paper whose width is 189.9 mm or less, the print speed may slow gradually.

Precautions for paper

["Precautions for Paper"](#)

NOTE

Printable area

["Printable Area"](#)

Envelope sizes

The envelope sizes are as follows.

Envelope Monarch	98.4 mm x 190.5 mm
Envelope No.10	104.7 mm x 241.3 mm
Envelope DL	110.0 mm x 220.0 mm
Envelope ISO-C5	162.0 mm x 229.0 mm
Envelope ISO-B5	176.0 mm x 250.0 mm

Chlorine-free paper

Chlorine-free paper can be used with this printer.

Paper Which Requires Attention Before Use

When using the following types of paper, this may cause influence to the printout results or printer in some cases.

Paper that was stored improperly

- Creased or folded paper
- Torn or damaged paper
- Wrinkled paper
- Curled paper
- Wet or moist paper
- Paper with rough edges
- Irregularly-shaped paper

Paper with holes or perforations

- Paper with binding holes
- Paper with perforations

Paper with adhesive or a special coating

- Heat-sensitive paper
- Paper with adhesive
- Carbon paper
- Treated color paper
- Specially coated paper (coated paper for ink jet printers, etc)

Paper that was printed by another printer

- Paper that was printed by a copy machine or another printer (The back side of the paper is also not usable.)

Paper that is difficult for the toner to fix onto

- Paper with rough surfaces
- Paper containing thick fibers
- Paper with an extremely rough or smooth surface
- Paper that is thicker or thinner than the specified usable paper
↳ "Usable Paper"

IMPORTANT

About paper with staples, clips, ribbons or tape

This kind of paper may result in the printer malfunction or damage to the printer.

About paper that contains ink that melts, burns, evaporates or emits harmful gases at or lower than the heating temperature of the fixing unit

This kind of paper may result in the printer malfunction or damage to the printer.

Printing on the back side of paper whose front side is already printed

This printer enables you to perform 2-sided printing by manually inserting the back side of the paper* whose front side was previously printed even if the paper cannot be used for 2-sided printing.

When printing on the back side of paper whose front side was previously printed, flatten out any curled paper and load one sheet of paper at a time in the multi-purpose tray.

* This is only for paper that has been printed using this printer. Also, you cannot print again on the same side of the paper that was printed before.

* If you are using A5 paper, the back side may not be printed correctly.

Storing Paper

The quality of paper may deteriorate if stored improperly even when the paper meets the normal specifications. Inferior paper may cause misfeeds, paper jams, or deterioration in print quality.

How to store paper

Observe the following guidelines when storing and handling paper.

- Store paper on a flat surface.
- To help paper avoid moisture or dryness, keep paper in its wrapper until it is ready to be used.
- Do not place paper in the condition where it may curl or become creased.
- Do not store paper vertically or store too many stacks of paper in one pile.

Do not store paper in the following locations.

- A location exposed to direct sunlight
- A location subject to high humidity
- A dry location
- A location with a temperature or humidity that differs significantly from the location where it will be used

If you print on damp paper

If you print on damp paper, steam may be emitted from the printer output area.

This is due to moisture in the paper evaporating because of the heat generated when toner fixes. This is not a malfunction. (This is likely to occur when the room temperature is low.)

Storing Printouts

When handling or storing paper printed by this printer, be careful of the following points.

How to store printouts

- Store paper on a flat surface.
- Avoid storing printouts in folders made of PVC material, as this may cause the toner to melt and stick to the PVC material. Toner may peel when printouts are folded or creased.
- Store printouts in the condition where they are not folded or creased as toner may peel.
- Avoid rubbing the printed paper with fingers or cloth because it may cause toner stain or toner peeling.
- Put printouts in a binder when storing for a long period of time (two years or longer).
- Printouts may discolor when stored for a long period of time.
- Avoid storing printouts in a location subject to high temperatures.

Precautions when sticking printouts with adhesive

- Be sure to use insoluble adhesive.
- Test the adhesive on an unneeded printout before using.
- Before stacking printouts that have adhesive, check that the adhesive completely dried.

Printable Area

04L9-037

NOTE

If you want to extend the printable area

Specify the following settings in the printer driver.

- **UFR II Printer Driver/PCL Printer Driver**

1. Click [Advanced Settings] in the [Finishing] sheet.
2. Set [Expand Print Region and Print] to [On].

- **PS Printer Driver**

See Help of the PS printer driver.

† The edges of the printout may be partly missing, depending on the settings of the document to be printed.

Plain Paper/Heavy Paper/Transparency/Label/Index Card

The printable areas are as follows.

- UFR II/PS Printer Driver

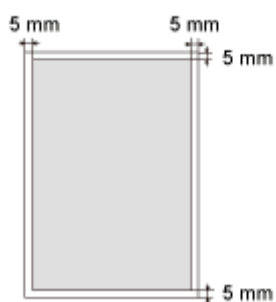

- PCL5e/PCL6 Printer Driver

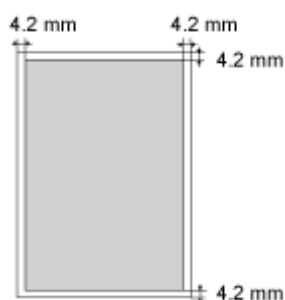

Envelope

This printer can print on the following area.

You may have to change the printable area before printing, depending on the application you use.

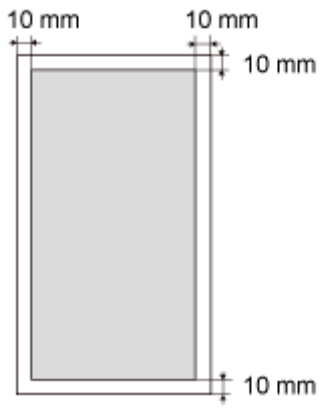

Paper Loading and Output

04L9-038

This printer has the following paper sources and output trays.

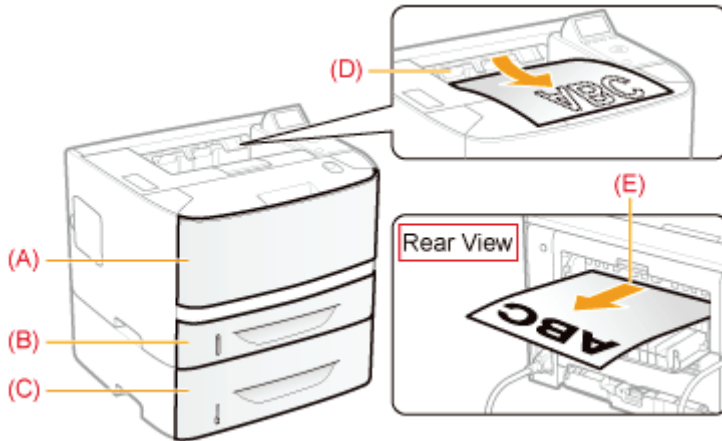

Paper Source	(A): Multi-purpose tray	➤ "Loading Paper in the Multi-purpose Tray"
	(B): Drawer 1	➤ "Loading Paper in the Paper Drawer"
	(C): Drawer 2 (optional)	
Output Tray	(D): Output tray	Outputs paper with the printed side face-down.
	(E): Sub-output tray	Outputs paper with the printed side face-up. The sub-output tray is suitable to print transparencies, labels, or envelopes which tend to curl, since the printed paper is output flat.

How to Switch Output Trays

- When switching to the sub-output tray**
 Open the output selection cover as shown in the figure.

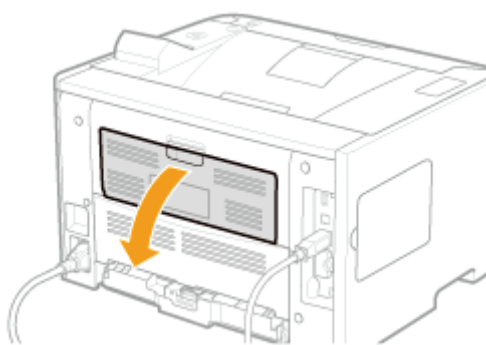

- When switching to the output tray**
 Close the output selection cover as shown in the figure.

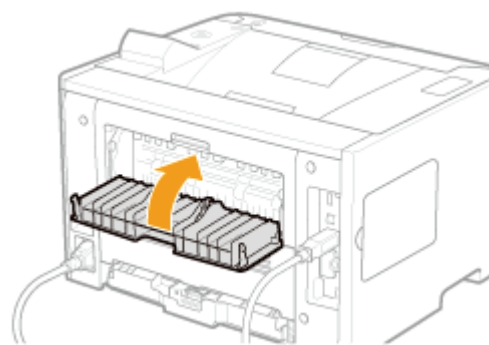

Precautions for Output Trays

Observe to the following points when handling the output trays.

Before handling the output trays, see "Important Safety Instructions."

- When performing 2-sided printing, close the output selection cover.
(When outputting paper to the sub-output tray, you cannot perform 2-sided printing.)
- During 2-sided printing, do not touch the paper until it is completely output. The paper is first partially output after the front side is printed, and then it is fed again to be printed on the back side.

- After paper is output to the sub-output tray, immediately remove each sheet.
- When outputting long-size paper, such as Legal paper, to the output tray, open the auxiliary tray to prevent the paper from hanging out of the output tray.



Paper Capacity of the Paper Sources and Output Trays

— : Unavailable

Paper Type	Paper Source			Output Tray	
	Multi-purpose tray	Drawer 1	Drawer 2 (optional)	Output tray ^{*1}	Sub-output tray
Plain paper (Ex.75 g/m ²)	Approx. 50 sheets	Approx. 250 sheets ^{*2}	Approx. 500 sheets ^{*2}	Approx. 150 sheets	1 sheet
Heavy paper (Ex.120 g/m ²)	Approx. 40 sheets	Approx. 200 sheets ^{*2}	Approx. 400 sheets ^{*2}	Approx. 20 sheets	1 sheet
Heavy paper (Ex.163 g/m ²)	Approx. 25 sheets	—	—	Approx. 20 sheets	1 sheet
Transparency	Approx. 15 sheets	—	—	1 sheet	1 sheet
Label	Approx. 20 sheets	—	—	Approx. 10 sheets	1 sheet
Index Card	Approx. 15 sheets	—	—	Approx. 10 sheets	1 sheet
Envelope	Approx. 5 sheets	—	—	Approx. 10 sheets	1 sheet

^{*1} Actual paper capacity varies depending on the installation environment and paper type to be used.

^{*2} If the paper size is smaller than A5 or Statement, the paper capacity is as follows.

Paper Type	Drawer 1	Drawer 2 (optional)
Plain paper (Ex.75 g/m ²)	Approx. 150 sheets	Approx. 400 sheets
Heavy paper (Ex.120 g/m ²)	Approx. 100 sheets	Approx. 300 sheets

Loading Paper in the Paper Drawer

04L9-039

NOTE

When loading custom size paper

The procedure for loading custom size paper is different from that for loading standard size paper. See "Loading Custom Size Paper."

Loading Standard Size Paper

- † For details on the paper that you can load in the paper drawer, see "Usable Paper."
- † Load paper in Drawer 2 (optional) in the same manner as you load paper in Drawer 1.

Before loading paper, see "Attention (Paper Drawer)."

1

Pull out the paper drawer.

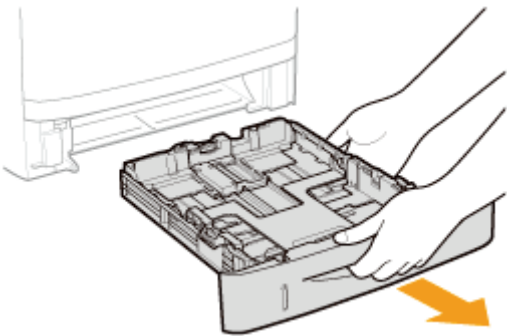

2

Slide the paper guides to the position of the size of the paper to be loaded.

While holding the lock release lever (A), adjust the guides.

- † Align the position of (B) with the size mark of the paper to be loaded.

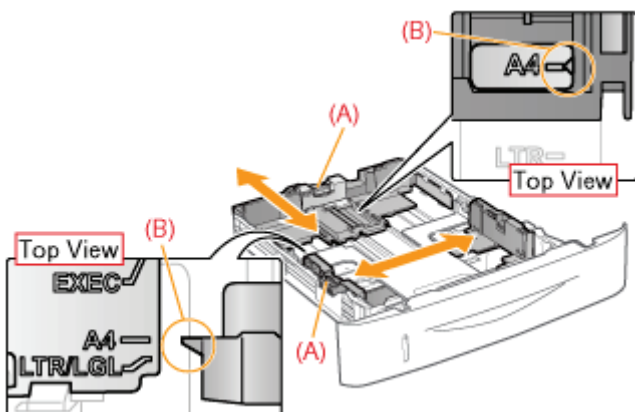

When loading A6 paper

Slide the paper guide at the rear center toward you.

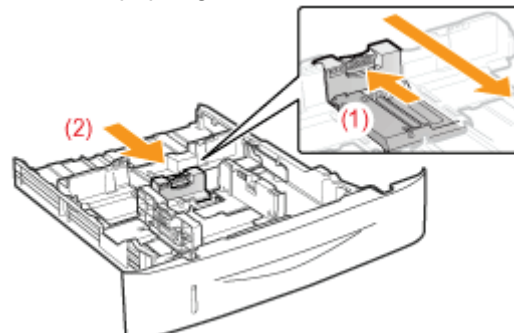

3

Load the paper with the printing side face-down, and the paper stack aligned with the rear paper guide.

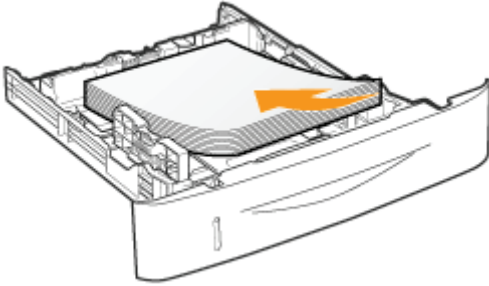

IMPORTANT

About the paper loading orientation

If you are not using the UFR II printer driver, load paper in portrait orientation. Also, be sure to load paper in landscape orientation if all the following conditions are met.

- You are using the UFR II printer driver.
- [Drawer 1 Size] and [Drawer 2 Size] are set to [Mixed Sizes].
- Custom size paper whose long edges are 215.9 mm or less is loaded.

NOTE

When loading paper with a letterhead or logo

See "[Paper Loading Orientation](#)" and load the paper in the correct orientation.

4

Hold down the paper, and then set it under the hooks (A) on the paper guides.

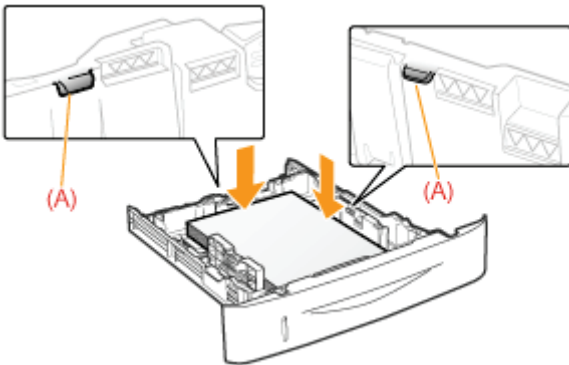

IMPORTANT

Be sure to align the paper guides to the paper.

If the paper guides are too loose or too tight, this may result in paper being misfed or paper jams.

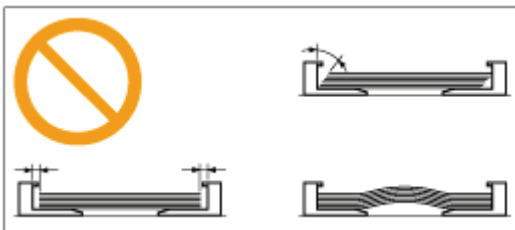

5

Make sure that the paper stack does not exceed the load limit mark lines (A) or (B).

(A): Paper larger than A5 or Statement

(B): A6 paper

† Be sure that the paper stack does not exceed the load limit mark lines. If the paper stack exceeds the load limit mark lines, this may result in paper being misfed.

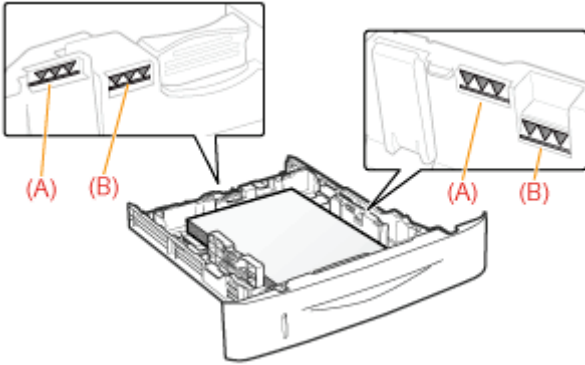

6

Set the paper drawer in the printer.

Next, register the paper size
➤ ["Registering the Paper Size"](#)

Attention (Paper Drawer)

04L9-03A

Before loading paper, see "Important Safety Instructions."

IMPORTANT

When loading paper for the first time after installing the paper feeder

Before loading paper, be sure to turn ON the printer once.

Do not touch the black rubber pad (A) in the paper drawer.

This may result in paper being misfed.

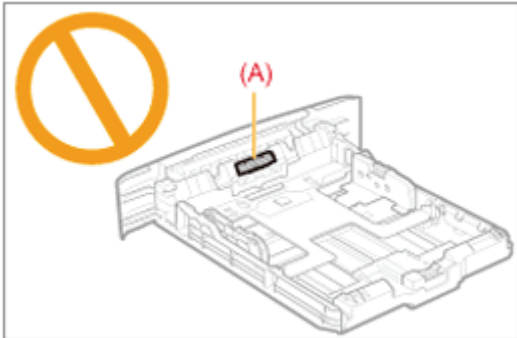

When printing from Drawer 2 (optional)

Make sure that Drawer 1 is set before printing from Drawer 2. If you print from Drawer 2 when Drawer 1 is not set, this will cause paper jams.

Do not pull out the paper drawer during printing.

This may result in paper jams or damage to the printer.

When using paper that is poorly cut

Multiple sheets of paper may be fed at a time. In this case, fan the paper thoroughly, and then align the edges of the stack properly on a hard, flat surface.

Loading Custom Size Paper

04L9-03C

NOTE

When loading custom size paper in the multi-purpose tray

Load them the same way as standard size paper.

➤ "Loading Paper in the Multi-purpose Tray"

Loading Custom Size Paper in the Paper Drawer

† For details on the paper that you can load in the paper drawer, see "Usable Paper."

† Load paper in Drawer 2 (optional) in the same manner as you load paper in Drawer 1.

Before loading paper, see "Attention (Paper Drawer)."

1

Pull out the paper drawer.

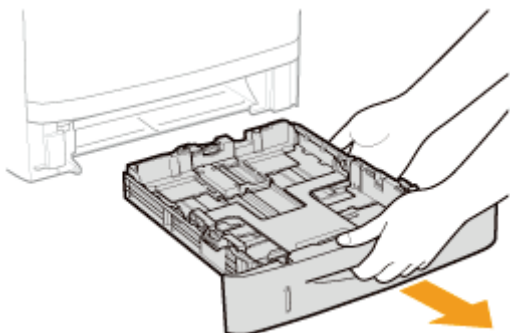

2

Spread the paper guides so they are a little wider than the actual paper width.

While holding the lock release lever (A), adjust the guides.

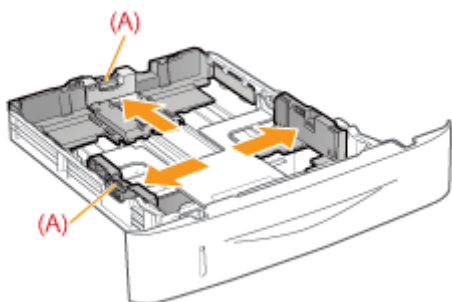

3

Load the paper with the print side face-down, and the edge of the paper stack aligned with the front side of the paper drawer.

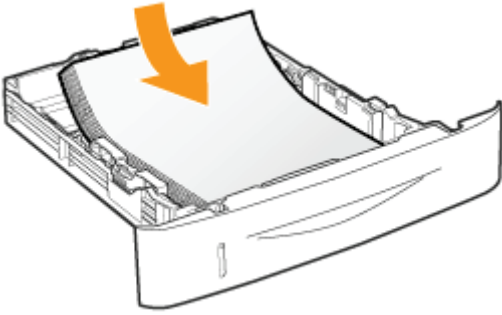

IMPORTANT

About the paper loading orientation

If you are not using the UFR II printer driver, load paper in portrait orientation. Also, be sure to load paper in landscape orientation if all the following conditions are met.

- You are using the UFR II printer driver.
- [Drawer 1 Size] and [Drawer 2 Size] are set to [Mixed Sizes].
- Custom size paper whose long edges are 215.9 mm or less is loaded.

NOTE

When loading paper with a letterhead or logo

See "Paper Loading Orientation" and load the paper in the correct orientation.

4

Align the paper guides to the loaded paper.

While holding the lock release lever (A), adjust the guides.

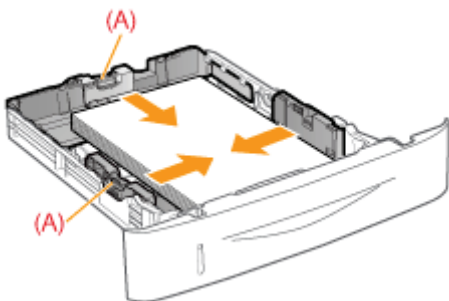

When loading paper shorter than A5:

Adjust the paper guide at the rear center to fit the length of paper.

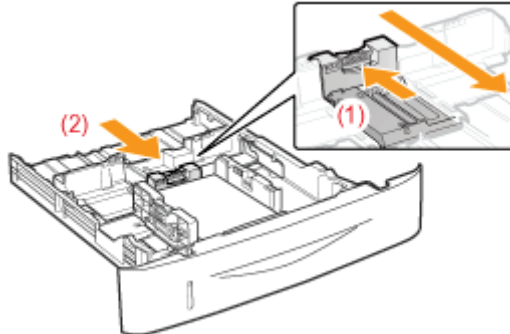

IMPORTANT

Be sure to align the paper guides to the paper.

If the paper guides are too loose or too tight, this may result in paper being misfed or paper jams.

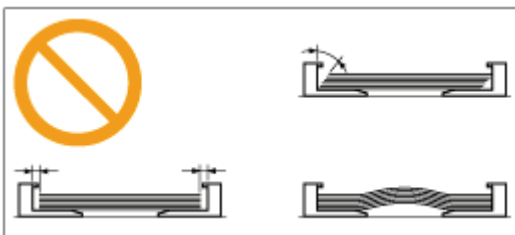

5

Make sure that the paper stack does not exceed the load limit mark lines (A) or (B).

(A): Paper larger than A5

(B): Paper smaller than A5

† Be sure that the paper stack does not exceed the load limit mark lines. If the paper stack exceeds the load limit mark lines, this may result in paper being misfed.

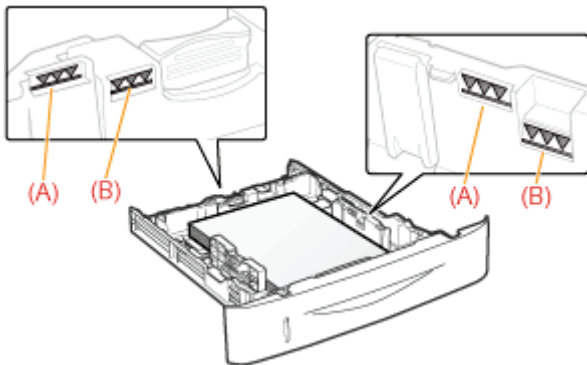

6

Set the paper drawer in the printer.

Next, register the paper size
➤ ["Registering the Paper Size"](#)

Loading Paper in the Multi-purpose Tray

04L9-03E

† For details on the paper that you can load in the multi-purpose tray, see "[Usable Paper](#)."

Before loading paper, see "[Attention \(Multi-purpose Tray\)](#)."

1

Open the multi-purpose tray, and then pull out the auxiliary tray.

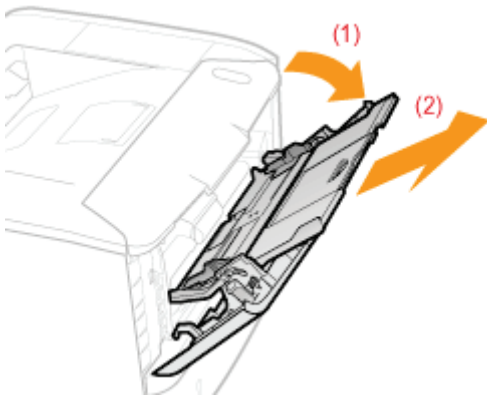

When loading long-size paper

Open the tray extension also.

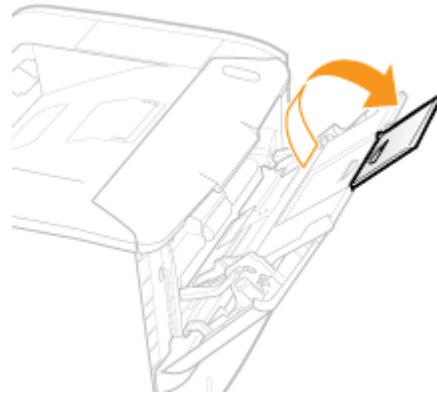

2

Slide the paper guides a little wider than the actual paper width.

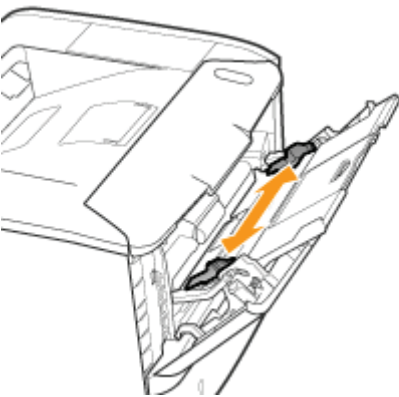

3

Gently load paper with the printing side face-up until it touches the back of the tray.

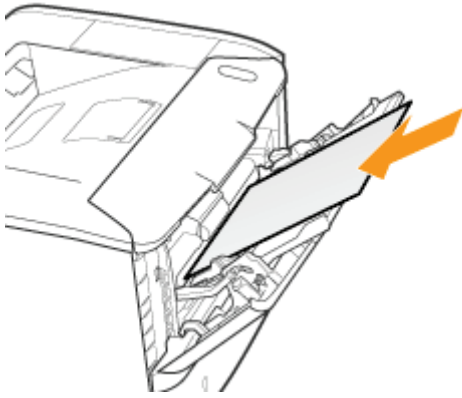

IMPORTANT

About the loading orientation of standard size paper

Be sure to load the paper in portrait orientation.

About the loading orientation of custom size paper

If you are not using the UFR II printer driver, load paper in portrait orientation.

Also, be sure to load paper in landscape orientation if all the following conditions are met.

- You are using the UFR II printer driver.
- [MP Tray Paper Size] is set to [Mixed Sizes].
- The long edges of the paper are 215.9 mm or less.

About the loading orientation of envelopes

See "[Printing on Envelopes](#)" and load envelopes in the correct orientation.

NOTE

When loading paper with a letterhead or logo

See "[Paper Loading Orientation](#)" and load the paper in the correct orientation.

4

Align the paper guides to the width of the paper.

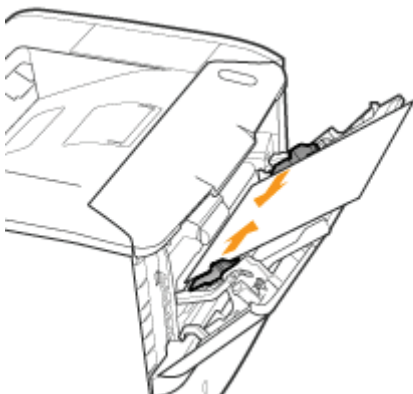

IMPORTANT

Be sure to align the paper guides to the width of the paper.

If the paper guides are too loose or too tight, this may result in paper being misfed or paper jams.

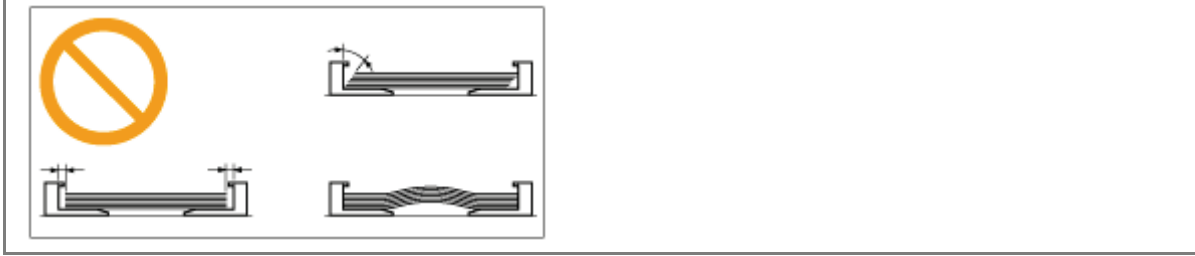

5

Be sure that the paper stack is loaded under the load limit guides (A).

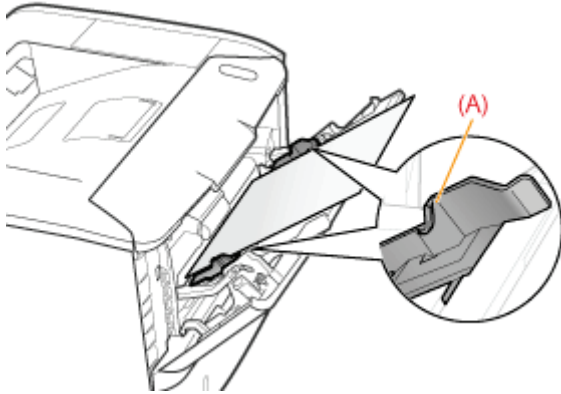

Next, register the paper size
➤ ["Registering the Paper Size"](#)

Attention (Multi-purpose Tray)

04L9-03F

Before loading paper, see "Important Safety Instructions."

IMPORTANT

Precautions when loading paper in the multi-purpose tray

- Load the paper so that it is straight.
- If the rear edge of the paper stack is not properly aligned, this may result in paper being misfed or paper jams.
- If the paper is curled or folded at the corners, flatten it before loading it in the printer.

Do not touch the paper in the multi-purpose tray or pull it out during printing.

This may result in paper jams or damage to the printer.

When using paper that is poorly cut

Multiple sheets of paper may be fed at a time. In this case, fan the paper thoroughly, and then align the edges of the stack properly on a hard, flat surface.

Do not place any objects other than paper on the multi-purpose tray. Do not press the top of or apply excessive force to the multi-purpose tray.

This may result in damage to the multi-purpose tray.

Registering the Paper Size

04L9-03H

This printer cannot automatically detect the paper size. Therefore, you need to register the size of the loaded paper. Register the paper size using the following procedure. (The paper size setting is set to [A4] by default.)

NOTE

Precautions when specifying [Mixed Sizes]

- The printer performs printing without checking the paper settings in the printer driver. Make sure that the paper specified in the printer driver matches that loaded in the paper drawer before using the printer.
- If you are using the UFR II printer driver, load custom size paper whose long edges are 215.9 mm or less in landscape orientation.

1

Press [] ( : Feeder Selection).

2

Select the paper source using [] and [], and then press [OK].

Select either [MP Tray Paper Size], [Drawer 1 Size] or [Drawer 2 Size].

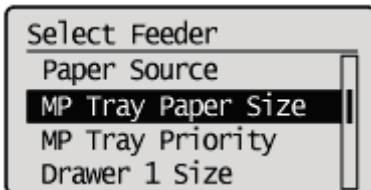

3

Select a paper size using [] and [], and then press [OK].

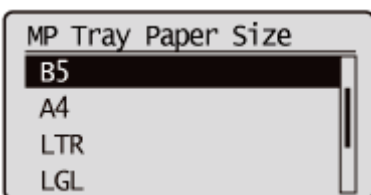

→ Paper size is registered.

 Next, specify the following settings.

When printing from the printer driver on Windows or Macintosh, configure the printer driver.

- ❖ ["Configuring the Printer Driver and Printing"](#)

When printing from DOS or UNIX, specify the settings for [Standard Paper Size] and [Default Paper Type] using the control panel.

- ❖ ["\[Setup\] Menu \(\[Paper Source\] Options\)"](#)

Configuring the Printer Driver and Printing

04L9-03J

After loading paper in a paper source, configure the printer driver to print using the following procedure. This section describes the basic procedure for printing from an application, taking Adobe Reader as an example.

† The printing procedure may differ depending on the application you are using.

Before printing, see "Attention (Printer Driver Configuration)."

1

Load paper in the paper drawer or multi-purpose tray.

➤ "Paper Loading and Output"

2

Open the PDF file to be printed using Adobe Reader.

3

Select [Print] from the [File] menu.

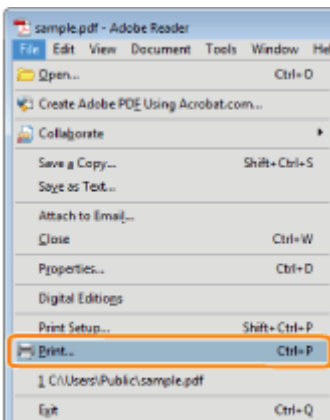

4

Configure the printing preferences.

(1) Select this printer.

† You can change the printer name in the printer folder (➤ "Basic Operations/Various Information for Windows").

(2) Configure the printing preferences.

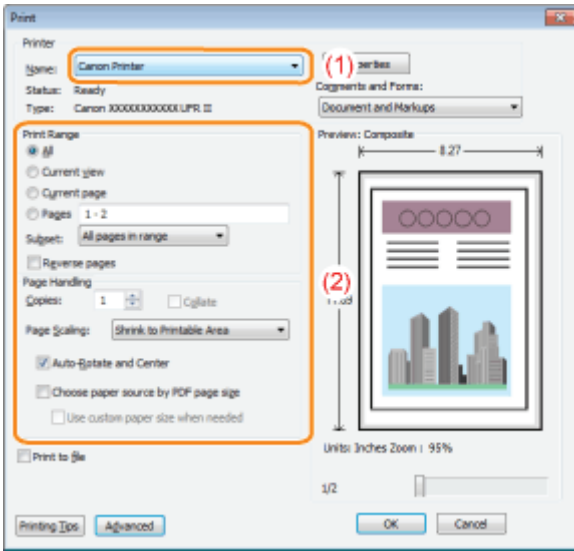

5

Click [Properties].

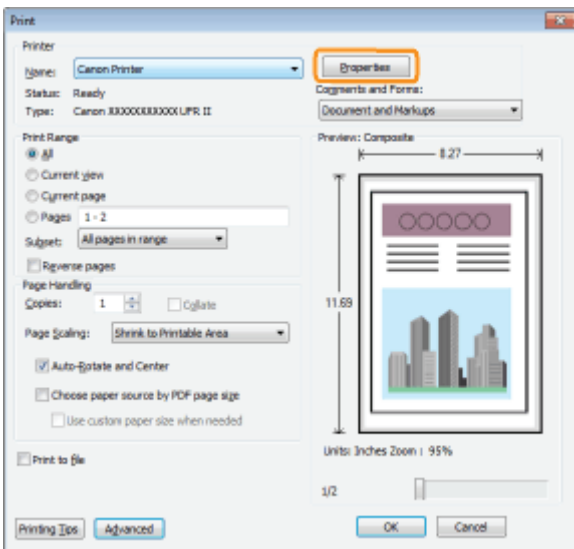

6

Specify the settings for [Page Size] and [Output Size].

- (1) Display the [Page Setup] sheet.
- (2) Select the page size of the document created by an application.
- (3) Select if the size of the paper to be printed is different from that of the data.

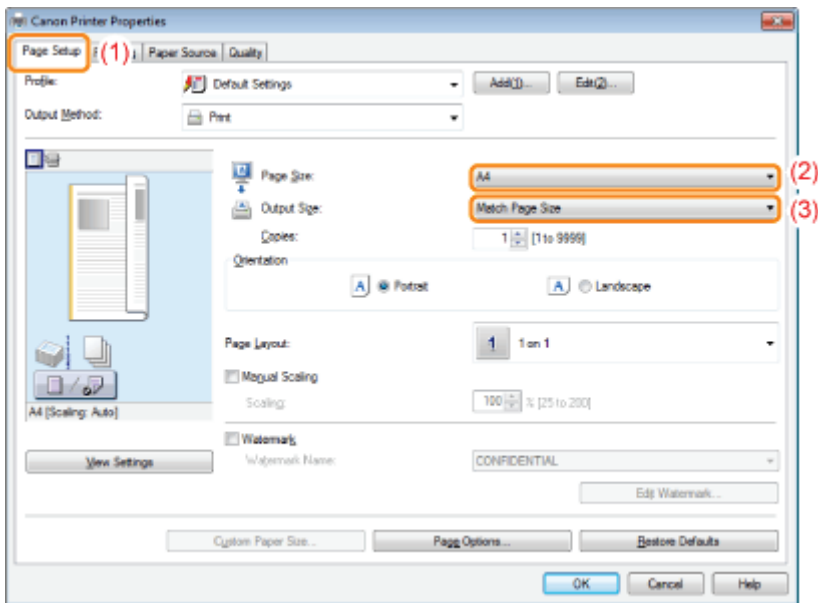

IMPORTANT

If the [Page Size] setting and [Output Size] setting are different

The print is automatically reduced or enlarged to fit on the page.

7

Specify the settings for [Paper Source] and [Paper Type].

- (1) Display the [Paper Source] sheet.
- (2) Set the paper source you want to use.
- (3) Select the type of the paper loaded in the paper source.*

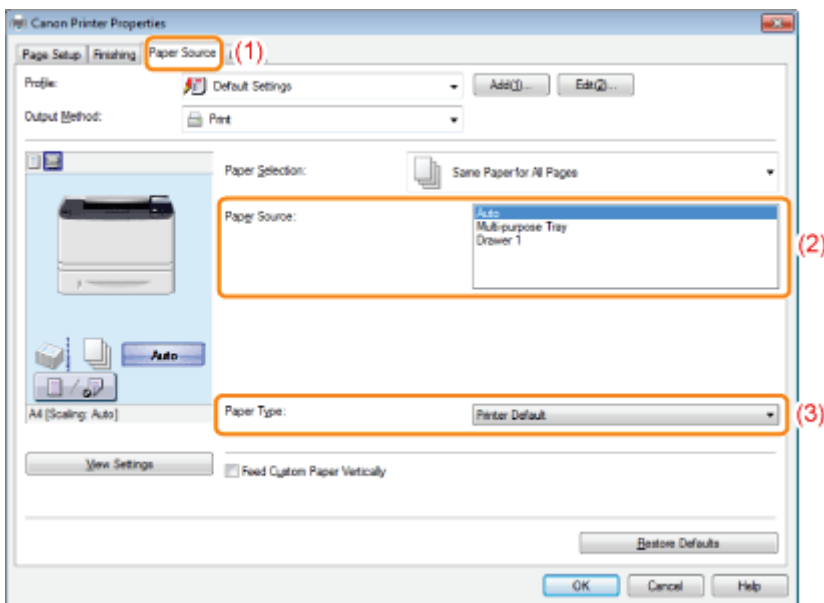

* Specify the setting according to the paper type as follows.

Paper Type		Setting for [Paper Type]
Plain Paper	60 to 90 g/m ²	[Plain] [Plain L]**
Heavy paper	91 to 150 g/m ²	[Heavy 1]
	151 to 163 g/m ²	[Heavy 2]
Transparency		[Transparency]
Label		[Labels]

Index Card	[Envelope]
Envelope	[Envelope]

** If the printed paper curls (the printed side curls outward) when printed with [Plain] selected, select [Plain L].

NOTE

Using Preview to specify a paper source

You can also specify a paper source by clicking each paper source or [Auto] using Preview when [] is selected.



8

Specify the other printing preferences as needed.

† "[Useful Printing Functions](#)" describes the printing procedures that use the various printing functions. Make full use of the functions of this printer.

NOTE

For details on the settings

See Help of the printer driver.

➤ "[Viewing the Online Help](#)"

9

Confirm the settings, and then click [OK].

→ The [Print] dialog box reappears.

10

Click [OK].

→ The printer starts printing.

If the printer cannot print properly



- "[Printing Cannot Be Performed \(USB Connection\)](#)"
- "[Printing Cannot Be Performed \(LAN Connection\)](#)"
- "[Printing Cannot Be Performed \(via the Print Server\)](#)"

IMPORTANT

Be sure to match the setting in the control panel.

Match the setting specified in the [Setup] menu and that specified in [Output Size] in the printer driver.

If they do not match, the message <Set below paper.> appears.

In this case, the setting for [MP Tray Paper Size], [Drawer 1 Size] or [Drawer 2 Size] is changed to that in the printer driver by pressing [] ( : Online), allowing you to continue printing.

➤ ["Registering the Paper Size"](#)

NOTE

About configuration samples

The display may differ depending on the operating system in addition to the type and version of the printer driver.

How to install the printer driver

- If you are using Windows, see "Printer Driver Installation Guide." To view "Printer Driver Installation Guide", see ["Installation."](#)
- If you are using Macintosh, see "Driver Guide." To view "Driver Guide", see ["Viewing the Driver Guide."](#)

When printing on custom size paper

You need to register the custom paper size in the printer driver previously.

For details on the procedure for registering a custom paper size, see Help of the printer driver.

➤ ["Viewing the Online Help"](#)

About the contents specified in "Configuring the Printer Driver and Printing"

The specified settings apply only to data to be printed from the same application. Exiting the application resets the changed settings to the default settings.

For details on the procedure for changing the default values for printing preferences, see ["Configuring the Print Settings Beforehand."](#)

Turning the Printer ON/OFF

04L9-03L

This section describes the procedures for turning the printer ON/OFF and checking the printer operation.

Before printing, see "Attention (Turning the Printer ON/OFF)."

Turning ON the Printer



To use this printer, press the power switch to turn the printer ON. After checking the status of the printer unit and optional accessories, the printer is ready to print.

1

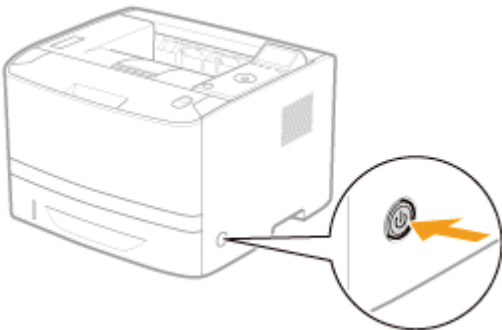
Press the power switch to turn the printer ON.



† The indicators and display on the control panel come on, and the printer initiates a self-diagnostic test on the printer unit and optional accessories.

If no abnormality is found during the self-diagnostic test, the Main Power indicator (green),  (Ready) indicator (green),  (Online) indicator (green) and Paper Source indicator (green) come on, <Ready to print.> appears in the display, and the printer is ready to print.

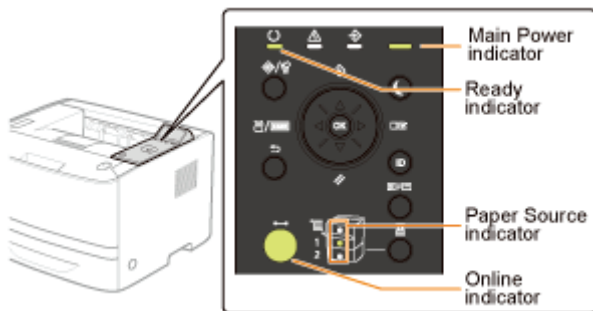

The following information is displayed in the display.

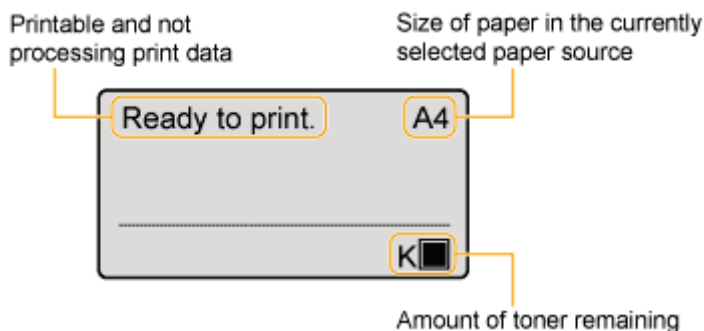

Turning OFF the Printer

To stop the printer properly, use the following procedure for turning the printer OFF.

1

Check that the printer is not performing the following operations.

- Printing
- While the printer is running a self-diagnostic test immediately after turning the power ON
- While the ↻ (Job) indicator is on or blinking
- When any of the following messages appears
 - <Starting up...>
 - <Initializing NVRAM>

2

Press [] (// : Reset).

3

Select [Shut Down] using [▲] and [▼], and then press [OK].

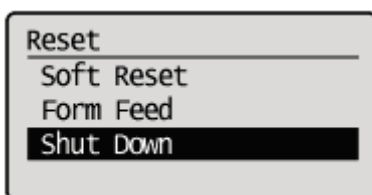

IMPORTANT

If "Could not execute." is displayed

There is a Secure Print job in the SD card.

If shutdown is running, after deleting the job using a soft reset, run the shutdown operation again.

If shutdown is not running, press [] (←→ : Online).

NOTE

When you are using WSD printing

The shutdown notifies the computer that the printer is turned OFF.

4

Select [Yes] using [▼], and then press [OK].

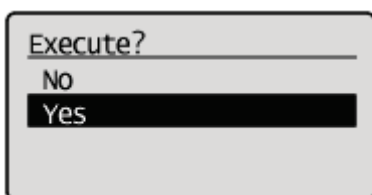

→ After the message appears, turn OFF the printer automatically.

Shutting down...
wait for prompt to
turn OFF main power.



 **NOTE**

If the printer is not turned OFF immediately

Depending on the process in the printer, it may take up to 10 minutes to turn the printer OFF.

Attention (Turning the Printer ON/OFF)

04L9-03R

IMPORTANT

Do not turn the printer ON immediately after turning it OFF.

If you want to cycle the power of the printer, wait at least 10 seconds before turning it ON again.

If the printer does not operate properly

➤ ["Troubleshooting"](#)

If an error message appears in the display on the control panel

➤ ["A Message Appears in the Control Panel"](#)

When turning ON the printer for the first time after installing the printer and paper feeder

Do not load paper in the paper drawer.

➤ ["Attention \(Printer Installation\)"](#)

Precautions when turning OFF the printer

- If you turn the printer OFF, all print data remaining in the printer memory will be erased.
- When you attempt to turn the printer OFF suddenly, an unexpected error may occur. Use the procedure described in the e-Manual to turn the printer OFF.

Power consumption when the power is OFF

Even if the printer is turned OFF, power is still consumed slightly while the power plug is inserted in the AC power outlet. To stop the power consumption completely, unplug the power plug from the AC power outlet.

Online and Offline

04L9-03S

When the printer can receive data from the computer and print the data, the printer is "Online". When the printer is disconnected with the computer and cannot receive data, the printer is "Offline."

To perform the settings for each menu using the control panel, switch the printer status as follows.

: You can enter the menu

— : You cannot enter the menu

	When the printer is online	When the printer is offline
[Setup] menu	<input type="radio"/> *	<input type="radio"/>
[Select Feeder] menu	<input type="radio"/>	<input type="radio"/>
[Reset] menu	<input type="radio"/>	<input type="radio"/>
[Job] menu	<input type="radio"/>	—
[Utility Menu] menu	<input type="radio"/>	—
Application menu (LBP6680x only)	<input type="radio"/>	<input type="radio"/>

* The [User Maintenance] options cannot be specified when the printer is online.

Placing the Printer Online

When printing from the computer, the printer has to be online.

If the printer is offline, place the printer online using the following procedure.

1

Press [] (↔ : Online).

The ↔ (Online) indicator turns on, and the printer is online.

IMPORTANT

If you cannot place the printer online

If an error is occurring in the printer, the printer does not come online.
Eliminate the cause of the error before you place the printer online.

NOTE



About the ↔ (Online) indicator during Sleep Mode

During Sleep Mode, the ↔ (Online) indicator is off even when the printer is online.

Placing the Printer Offline

To configure the printer so that it does not receive data from the computer or specify the settings for all the items in the [Setup] menu, place the printer offline using the following procedure.

1

Press [] ( : Online).

The  (Online) indicator goes off, and the printer is offline.

 **IMPORTANT**

About the automatic online function

- You can specify the time interval until the printer automatically enters the online status. The default is [2 minutes].
[\[Setup\] Menu \(\[Control Menu\] Options\)](#)
- The printer does not automatically enter online status in the following cases.
 - The printer is in error status.
 - The printer is in Sleep mode.
 - [Auto Reset Time] under [Timer Settings] is set to [Off].

Canceling a Job

04L9-03U



You can cancel a print job using either of the following methods.

Operations from the Computer

You can select jobs from the print queue and cancel them.

- † When the printer is connected to the computer using a LAN cable, you can cancel printing from the Remote UI.
 - "Managing Print Jobs"

Canceling from the Printer Control Panel

You can press [●] ( /  : Job Status/Cancel) and cancel the job.
You can cancel other user's jobs.

<If an error is occurring to a job>

Solve the problem using either of the following methods.

- **Outputting Data (Forced Output)**
You can force the printer to output the print data.
 - "Outputting Data (Forced Output)"
- **Canceling the Process Currently Being Performed (Soft Reset)**
You can cancel the process currently being performed.
 - "Canceling the Process Currently Being Performed (Soft Reset)"

<When canceling all the jobs>

You can cancel all the jobs using the following method.

- **Canceling All the Jobs (Hard Reset)**
You can delete all the jobs or data which was already sent to the memory.
 - "Canceling All the Jobs (Hard Reset)"

Operations from the Computer

04L9-03W

- † This section describes the procedure for when you are using Windows.
If you are using Macintosh, see "Driver Guide."
For details on the procedure for viewing Driver Guide, see "[Viewing the Driver Guide.](#)"

1

Display the print queue.

1. Open the printer folder.
❖ "[Basic Operations/Various Information for Windows](#)"
2. Double-click the icon for this printer.

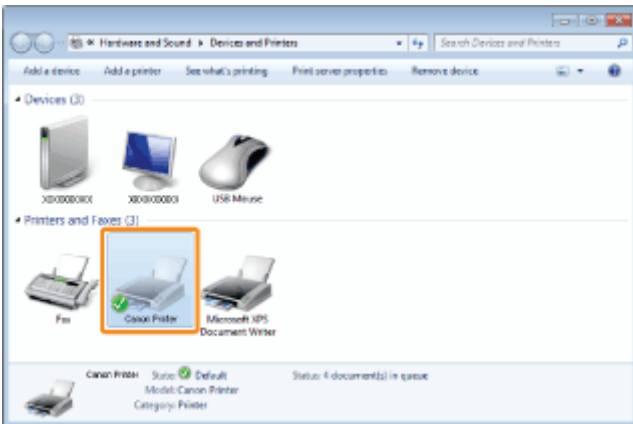

2

Right-click the job that you want to cancel, and then select [Cancel] from the pop-up menu.

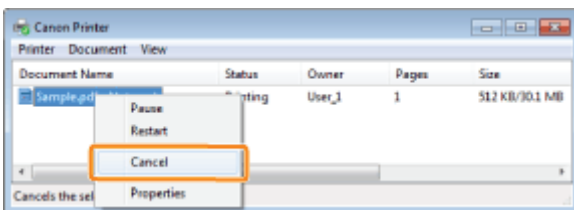

? If a print job does not appear

Another user's job is not displayed. (For the print server environment, all print jobs are displayed on the print server.)

If an error is occurring with a print job from another user, press the [●] (◆/🗑️: Job Status/Cancel) key to cancel the job.

❖ "[Cancelling from the Printer Control Panel](#)"

NOTE

For details on the print queue

See Windows Help.

3

Click [Yes] to cancel the print job.

? If you cannot cancel a job

You cannot cancel the job whose pages are in the process of printing.

Canceling from the Printer Control Panel

04L9-03X

When you want to cancel printing using the printer's control panel, run "Job Cancel" using the following procedure. A job cancel allows you to cancel the job currently being received or processed.

IMPORTANT

The data for which the printer started to feed paper cannot be canceled.

If the job is canceled in this state, the next print job may be canceled.

About print jobs for other than the printer driver for this printer

When there is any print data for other than the printer driver for this printer, multiple data may be canceled.

NOTE

About print jobs which cannot be canceled (LBP6680x only)

When canceling a job, you may not be able to cancel the job even if <Canceling jobs...> is displayed.

Also, you cannot cancel the following jobs.

- Jobs saved to boxes

Delete such jobs using the Remote UI.

[▶ "Remote UI"](#)

1

Make sure that the  (Job) indicator is on or blinking.

Cancel the job while the printer is processing the data (while the  (Job) indicator is on or blinking).

2

Press the [] (: Job Status/Cancel) key.

3

Select a job you want to cancel using [] and [], and then press [OK].

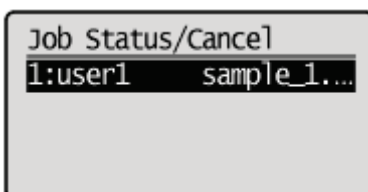

4

Select [Yes] using [] and [], and then press [OK].

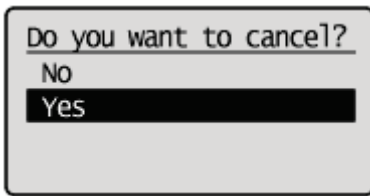

→ <Canceling jobs...> appears, and the print data being processed is canceled.
When <Ready to print.> appears, the job cancellation completes.

 **IMPORTANT**

While <Canceling jobs...> is displayed

You cannot operate the printer.

Outputting Data (Forced Output)

04L9-03Y

When a job is canceled from the computer or the data is less than one page, the data may remain in the printer memory, and the job may not be completed properly. As long as the printer remains in this state, you cannot perform printing because the printer cannot receive the next data.

In this case, force the printer to output the print data using the following procedure.

IMPORTANT

If you cannot output data

You cannot output data for the following jobs or in the following state.

- Data from the PCL/PS/UFR II printer driver
- When the  (Message) indicator is on

Perform a soft reset.

- "Canceling the Process Currently Being Performed (Soft Reset)"

The data that is being printed is deleted.

When you output data, print it again.

NOTE

About automatic output

When [Timeout] under [Interface] in the Setup Menu is set to [On], even less than a page of data is discharged automatically. (Data from the PCL/UFR II printer driver is not output.) [Timeout] for a job is set to 15 seconds in the default settings.

1

Press [] (// : Reset).

2

Select [Form Feed] using [▲] and [▼], and then press [OK].

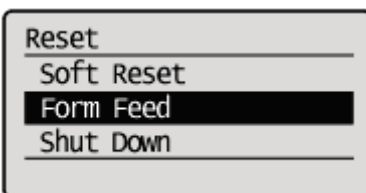

3

Select [Yes] using [▼], and then press [OK].

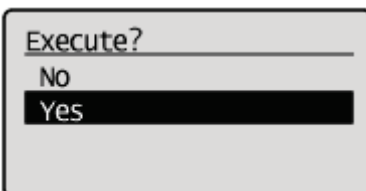

→ The data remaining in the memory is printed.

 **IMPORTANT**

If the  (Job) indicator does not go off even after outputting the data

Perform a soft reset.

-  "Canceling the Process Currently Being Performed (Soft Reset)"

Canceling the Process Currently Being Performed (Soft Reset)

04L9-040

If you want to cancel the process currently being performed, perform [Soft Reset] using the following procedure.

IMPORTANT

The data that is being printed, that is on the print queue, or that is being received is deleted.

Performing a soft reset deletes all the jobs (those from other computers and interfaces).
Make sure that other users are not printing before performing a soft reset.

NOTE

About the difference from a hard reset

Hard resets delete all the registered files, such as the form data saved in the RAM of the printer, but soft resets do not delete them.

1

Cancel printing from the computer.

2

Press [] (// : Reset).

3

Select [Soft Reset] using [▲] and [▼], and then press [OK].

Hold down the [OK] key 5 seconds or more if you want to perform a [Hard Reset].

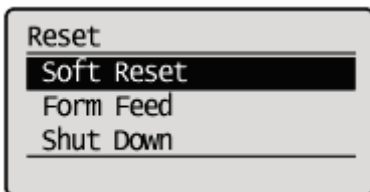

4

Select [Yes] using [▼], and then press [OK].

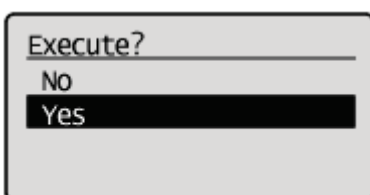

→ When <Resetting software...> disappears, the soft reset is completed.

Canceling All the Jobs (Hard Reset)

04L9-041

When you want to delete all the jobs and data sent to memory for some reason, perform [Hard Reset] using the following procedure.

IMPORTANT

The data that is being printed, that is on the print queue, or that is being received is deleted.

Performing a hard reset deletes all the jobs (those from other computers and interfaces).
Make sure that other users are not printing before performing a hard reset.

If the printer is reset while it is receiving data

The data that is not being received will be received after the resetting process completes. However, the data may not be printed properly.

NOTE

About the difference from a soft reset

Hard resets delete all the registered files, such as the form data saved in the RAM of the printer, but soft resets do not delete them.

1

Press [] (// : Reset).

2

Select [Soft Reset] using [▼], press [OK] for at least five seconds, and then release your finger.

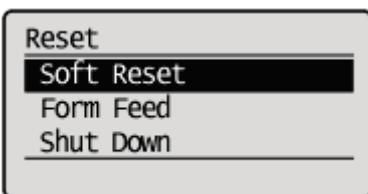

→ When you release your finger, <Execute hard reset?> is displayed.

3

Select [Yes] using [▼], and then press [OK].

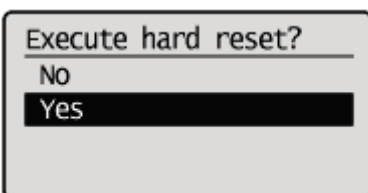

→ When <Resetting hardware...> disappears, the hard reset is completed.

Checking the Printer Status

04L9-042

You can check the current printer status from the Remote UI portal page or the [Status Monitor/Cancel] page.

❏ "Screen Layout of the Remote UI (Details on Each Setting Page)"

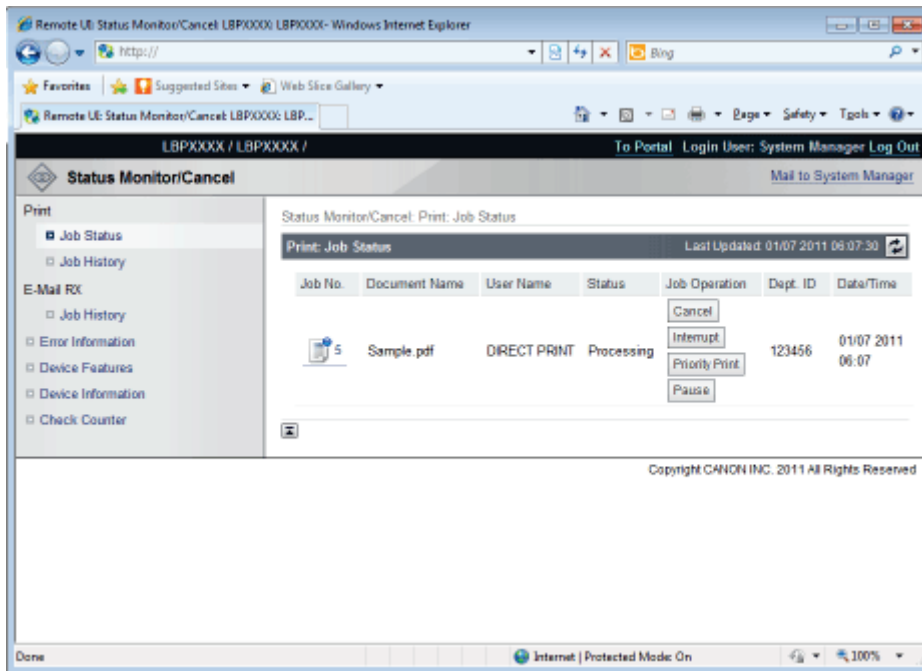

Printing on Various Types of Paper

04L9-043

➤ **Printing on Plain Paper, Heavy Paper, or Index Card**

➤ **Printing on Transparencies**

➤ **Printing on Labels**

➤ **Printing on Envelopes**

➤ **Printing on Custom Size Paper**

➤ **Paper Loading Orientation**

Printing on Plain Paper, Heavy Paper, or Index Card

04L9-044

Confirming usable paper

This printer can print on plain paper (60 to 90 g/m²) and heavy paper (91 to 163 g/m²) of the following sizes or Index Card.

† Heavy paper of 121 to 163 g/m² can only be loaded in the Multi-purpose tray.

	Paper Drawer	Multi-purpose Tray
Standard sizes	A4* ¹ , B5, A5, A6, Legal* ¹ , Letter* ¹ , Executive and 16K	A4* ¹ , B5, A5, A6, Legal* ¹ , Letter* ¹ , Executive, Statement, 16K, and Index Card
Custom paper sizes	Width 105.0 to 215.9 mm, Length 148.0 to 355.6 mm* ²	Width 76.2 to 215.9 mm, Length 127.0 to 355.6 mm* ³

*¹ Can be used for 2-sided printing (121 to 163 g/m² heavy paper cannot be used).

*² If you are using the UFR II printer driver, you can load custom size paper that is 148.0 to 215.9 mm wide and 148.0 to 215.9 mm long in landscape orientation.

*³ If you are using the UFR II printer driver, you can load custom size paper that is 127.0 to 215.9 mm wide and 127.0 to 215.9 mm long in landscape orientation.

† Recycled paper can be also used.

NOTE

When using custom size paper

See "[Printing on Custom Size Paper.](#)"

Loading paper

The paper which you can load in the paper drawer or multi-purpose tray varies depending on the paper type.

○ : Available — : Unavailable

Paper Type	Paper Drawer	Multi-purpose Tray
Plain paper (60 to 90 g/m ²)	○	○
Heavy paper (91 to 120 g/m ²)	○	○
Heavy paper (121 to 163 g/m ²)	—	○
Index Card	—	○

❖ "[Loading Paper in the Paper Drawer](#)"

❖ "[Loading Paper in the Multi-purpose Tray](#)"

Printing from an application

After loading paper, perform printing.

❖ "[Configuring the Printer Driver and Printing](#)"

† The print speed drops when printing on heavy paper (91 to 163 g/m²).

Printing on Transparencies

04L9-045

Confirming usable transparencies

This printer can use the following sizes of transparencies.

Standard sizes

A4, Letter

Loading transparencies

You can load transparencies only in the multi-purpose tray.

➤ ["Loading Paper in the Multi-purpose Tray"](#)

<Precautions when loading transparencies>

- Thoroughly fan the transparencies, and then align the edges before loading them as they may stick to each other. If they are not fanned enough, multiple sheets of paper may be fed at once, causing paper jams.

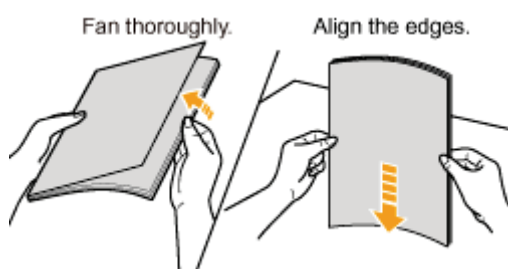

- When fanning or aligning the transparencies, try to hold the edges to avoid touching the printing surface.
- Take care not to mark or stain the printing surface of the transparencies with fingerprints, dust, or oil. This may result in poor print quality.

Printing from an application

After loading transparencies, perform printing.

➤ ["Configuring the Printer Driver and Printing"](#)

† Take out one sheet at a time each time a transparency is output.

? If the output labels curl

Switch the output tray to the sub-output tray.

➤ ["Paper Loading and Output"](#)

Confirming usable labels

This printer can use the following sizes of labels.

Standard sizes	A4, B5, A5, A6, Legal, Letter, Executive, Statement, and 16K
Custom paper sizes	Width 76.2 to 215.9 mm, Length 127.0 to 355.6 mm*

* If you are using the UFR II printer driver, you can load custom size paper that is 127.0 to 215.9 mm wide and 127.0 to 215.9 mm long also in landscape orientation.

† Using the following types of labels may result in paper jams that are difficult to clear or may result in damage to the printer.

- Peeled labels or partly used labels
- Coated labels that are easily peeled off from the backing sheet
- Labels with uneven adhesive

Loading labels

You can load labels only in the multi-purpose tray.

➤ ["Loading Paper in the Multi-purpose Tray"](#)

<Precautions when loading labels>

- Fan the labels thoroughly, and then align the edges before loading them. If they are not fanned enough, multiple sheets of paper may be fed at once, causing paper jams.

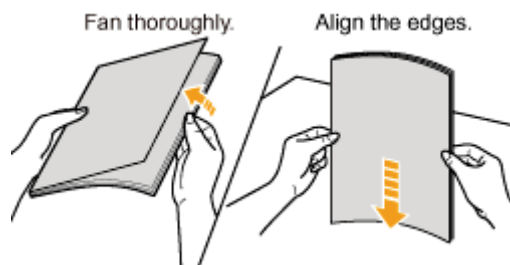

- Take care not to mark or stain the printing surface of the labels with fingerprints, dust, or oil. This may result in poor print quality.

Printing from an application

After loading labels, perform printing.

➤ ["Configuring the Printer Driver and Printing"](#)

† The print speed drops when printing on labels.

? If the output labels curl

Switch the output tray to the sub-output tray.

➤ ["Paper Loading and Output"](#)

Confirming usable envelopes

This printer can use the following envelopes.

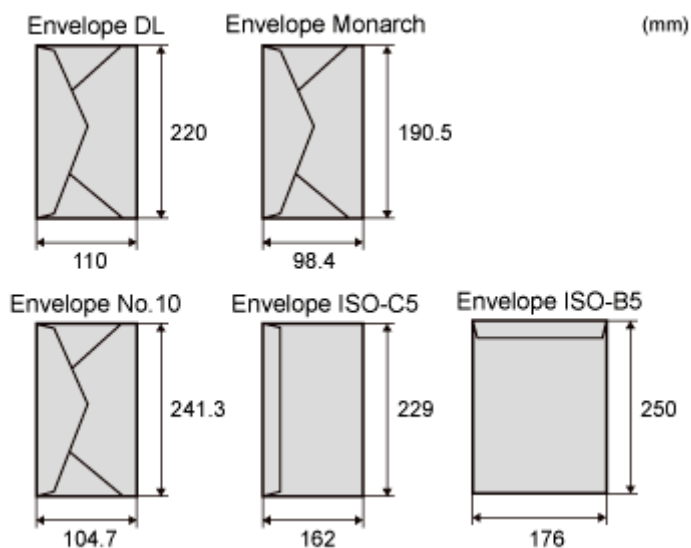

† Using the following types of envelopes may result in paper jams that are difficult to clear or may result in damage to the printer.

- Envelopes with fasteners or snaps
- Envelopes with address windows
- Envelopes with adhesive on the surface
- Wrinkled or creased envelopes
- Poorly manufactured envelopes in which the glued parts are uneven
- Irregularly-shaped envelopes

Loading envelopes

You can load envelopes only in the multi-purpose tray.

➤ ["Loading Paper in the Multi-purpose Tray"](#)

<Precautions when loading envelopes>

- Load envelopes in the correct orientation as follows.

(← : Feeding direction)

Envelope COM10, Envelope C5, Envelope DL,
and Envelope Monarch
<With the front side face-up>

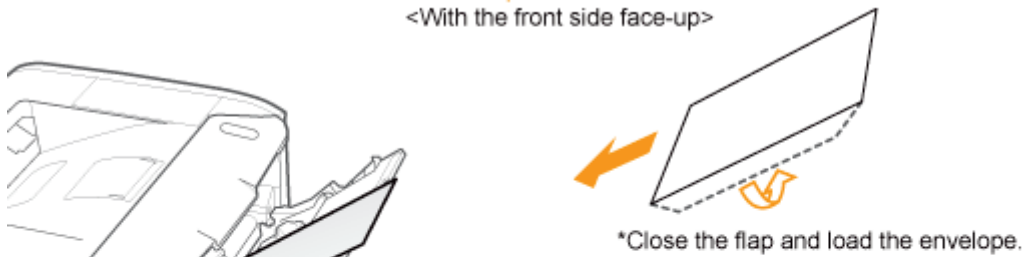

Envelope B5
<With the front side face-up>

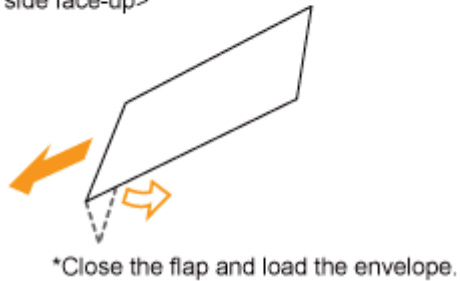

- Before loading envelopes, align them as follows.

1. Place the stack of envelopes on a flat surface, and then flatten them to release any remaining air.

Then, press the edges tightly.

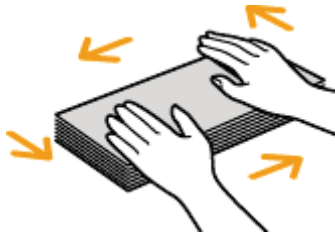

2. Loosen any stiff corners of the envelopes and flatten curls as shown in the figure.

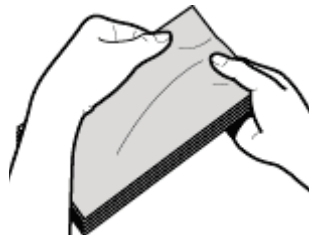

3. Align the edges of the envelopes on a flat surface.

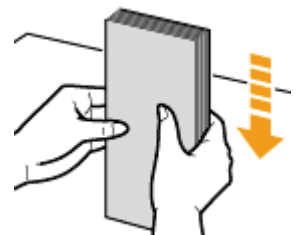

Printing from an application

After loading envelopes, perform printing.

❖ "Configuring the Printer Driver and Printing"

- † Do not print on the reverse side (glued side) of envelopes.
- † The print speed drops when printing on envelopes.
- † When envelopes are printed, they may be creased.

❓ If the output envelopes curl

Switch the output tray to the sub-output tray.

❖ "Paper Loading and Output"

Printing on Custom Size Paper

04L9-049

Confirming usable custom size paper

This printer can use the following custom size paper.

Paper Drawer	Width 105.0 to 215.9 mm, Length 148.0 to 355.6 mm ^{*1}
Multi-purpose tray	Width 76.2 to 215.9 mm, Length 127.0 to 355.6 mm ^{*2}

^{*1} If you are using the UFR II printer driver, you can load custom size paper that is 148.0 to 215.9 mm wide and 148.0 to 215.9 mm long in landscape orientation.

^{*2} If you are using the UFR II printer driver, you can load custom size paper that is 127.0 to 215.9 mm wide and 127.0 to 215.9 mm long in landscape orientation.

Loading custom size paper

The custom size paper which you can load in the paper drawer or multi-purpose tray varies depending on the paper type.

○ : Available

Paper Type	Paper Drawer	Multi-purpose Tray
Plain paper (60 to 90 g/m ²)	○	○
Heavy paper (91 to 120 g/m ²)	○	○
Heavy paper (121 to 163 g/m ²)	—	○

❖ ["Loading Custom Size Paper"](#)

Registering a custom paper size

If printing custom size paper, you need to register the custom paper size in the printer driver previously.

For details on the procedure for registering a custom paper size, see Help of the printer driver.

❖ ["Viewing the Online Help"](#)

Printing from an application

After loading custom size paper, perform printing.

❖ ["Configuring the Printer Driver and Printing"](#)

† The print speed drops when printing on heavy paper (91 to 163 g/m²).



Paper Loading Orientation

04L9-04A

To print paper with letterheads or logos, load the paper in the proper orientation as follows.

† When printing on envelopes, see "[Printing on Envelopes.](#)"

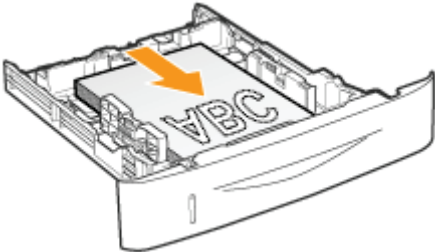
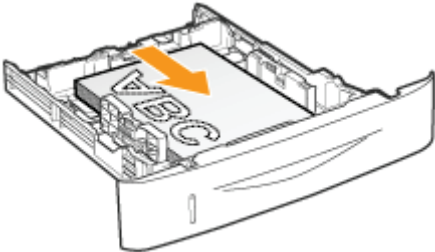
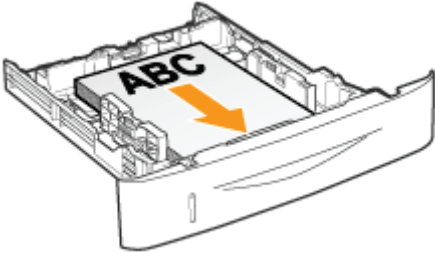
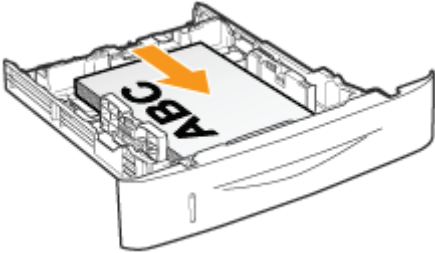
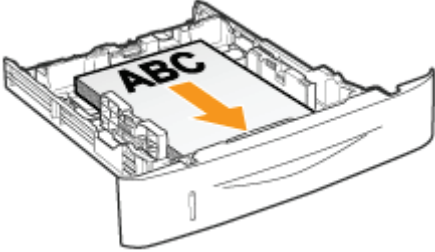
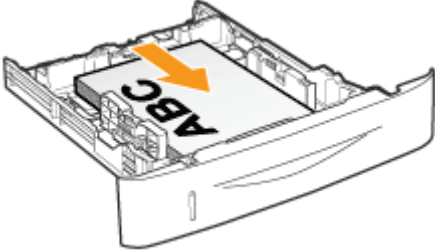
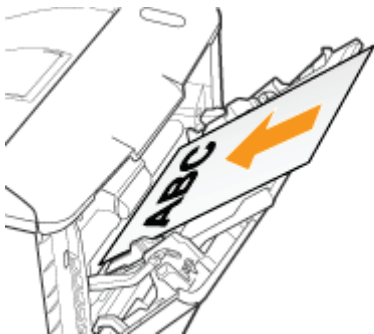
(→: Feeding direction)

	Portrait Layout	Landscape Layout
Paper Drawer (1-sided printing) *1	 <p>(With the printing side face-down)</p>	 <p>(With the printing side face-down)</p>
Paper Drawer (1-sided printing) *2	 <p>(With the printing side face-up)</p>	 <p>(With the printing side face-up)</p>
Paper Drawer (2-sided printing)	 <p>(With the front side face-up)</p>	 <p>(With the front side face-up)</p>
Multi-purpose tray (1-sided printing) *1	 <p>(With the printing side face-up)</p>	 <p>(With the printing side face-up)</p>
Multi-purpose tray (1-sided printing) *2		

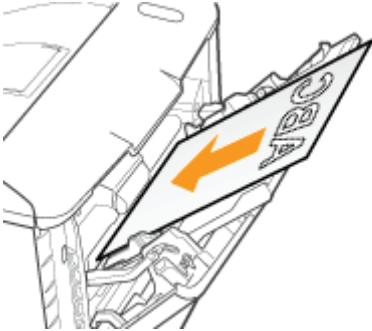
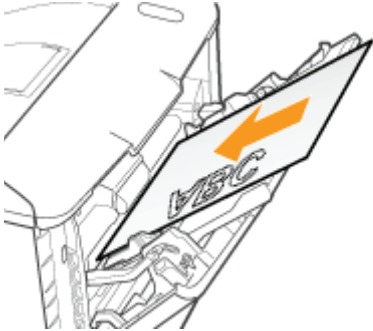
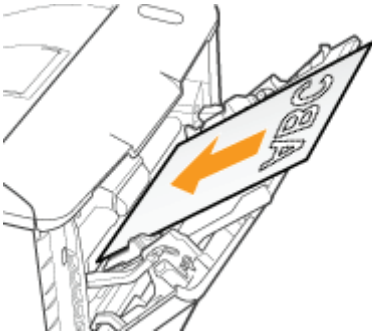
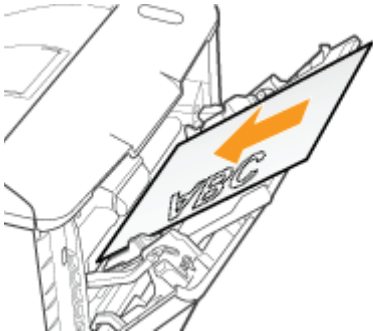
	 <p>(With the printing side face-down)</p>	 <p>(With the printing side face-down)</p>
<p>Multi-purpose tray (2-sided printing)</p>	 <p>(With the front side face-down)</p>	 <p>(With the front side face-down)</p>

*1 With [Paper Feed Method] set to [Speed Priority]

*2 With [Paper Feed Method] set to [Print Side Priority]

For details on [Paper Feed Method], see "[Setup] Menu ([User Maintenance] Options)."

➤ **Printing from a Computer (Windows)**

- Printing Fundamentals
- Printing Functions
- Scaling Documents
- Printing Multiple Pages on One Sheet
- 1-sided Printing and 2-sided Printing
- Booklet Printing
- Poster Printing
- Watermark Printing
- Combining and Printing Multiple Files
- Selecting a Profile for Printing
- Registering a Profile for Printing

➤ **Printing from a Computer (Macintosh)**

- Printing Fundamentals
- Printing Functions
- Scaling Documents
- Printing Multiple Pages on One Sheet
- 1-sided/2-sided Printing
- Using [Presets] for Printing

➤ **Setting Priority (When Specifying the Same Item Using Multiple Methods)**

➤ **Functions Which Can Be Specified from the Control Panel**

➤ **Printing without the Printer Driver (Direct Print)**

➤ **Printing Files Directly from USB Memory Devices (USB Direct Print) (LBP6680x Only)**

➤ **Receiving E-mail Data on the Mail Server and Printing (E-mail Print)**

➤ **Printing Files from the Printer Using FTP Client**

➤ Specifying a Password for a Document and Printing (Secured Print) (LBP6680x Only)

➤ Saving a Document in the SD Card in the Printer (Stored Job Print) (LBP6680x Only)

➤ Giving Priority to a Print Job (Interrupt Printing) (LBP6680x Only)

Printing from a Computer (Windows)

04L9-04E

▸ Printing Fundamentals

- Printing with the Printer Driver
- Configuring the Print Settings Beforehand
- Setting the Printer Options
- Viewing the Online Help

▸ Printing Functions

- Common Functions
- [Page Setup] Sheet
- [Finishing] Sheet
- [Paper Source] Sheet
- [Quality] Sheet
- [Device Settings] Sheet

▸ Scaling Documents

▸ Printing Multiple Pages on One Sheet

▸ 1-sided Printing and 2-sided Printing

▸ Booklet Printing

▸ Poster Printing

▸ Watermark Printing

▸ Combining and Printing Multiple Files

▸ Selecting a Profile for Printing

▸ Registering a Profile for Printing

Printing Fundamentals

04L9-04F

This section explains the basic printing method using the printer driver, how to set the printer options, and how to display the online help.

- ❖ [Printing with the Printer Driver](#)
 - ❖ [Configuring the Print Settings Beforehand](#)
 - ❖ [Setting the Printer Options](#)
 - ❖ [Viewing the Online Help](#)
-

Printing with the Printer Driver

04L9-04H

This section explains the basic printing method using the printer driver.

NOTE

Printing methods may differ depending on the application you are using. For details, see the instruction manuals provided with the application.

1.

Select **[Print]** from the **[File]** menu of the application.

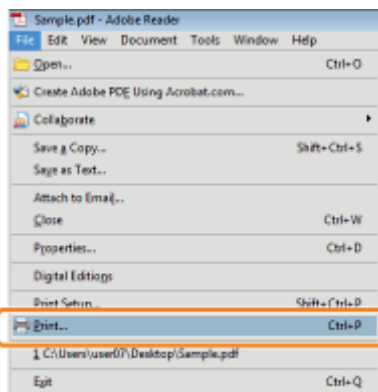

2.

Select your printer from **[Name]** → click **[Properties]**.

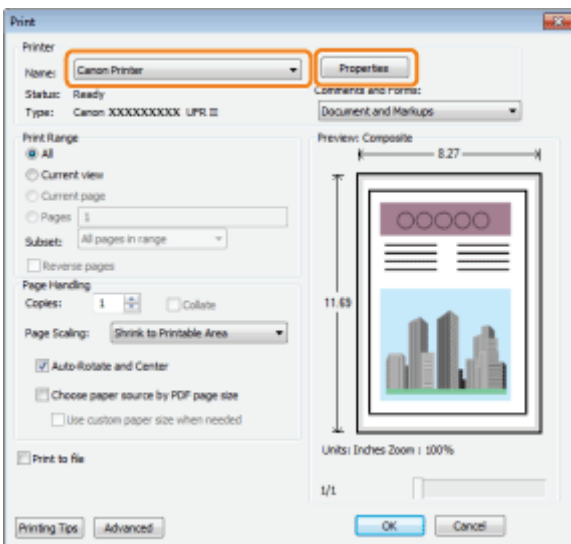

3.

Specify the desired settings in the printer driver screen → click **[OK]**.

Click the tabs for the [Page Setup], [Finishing], [Paper Source], and [Quality] sheets, and then specify the desired items.

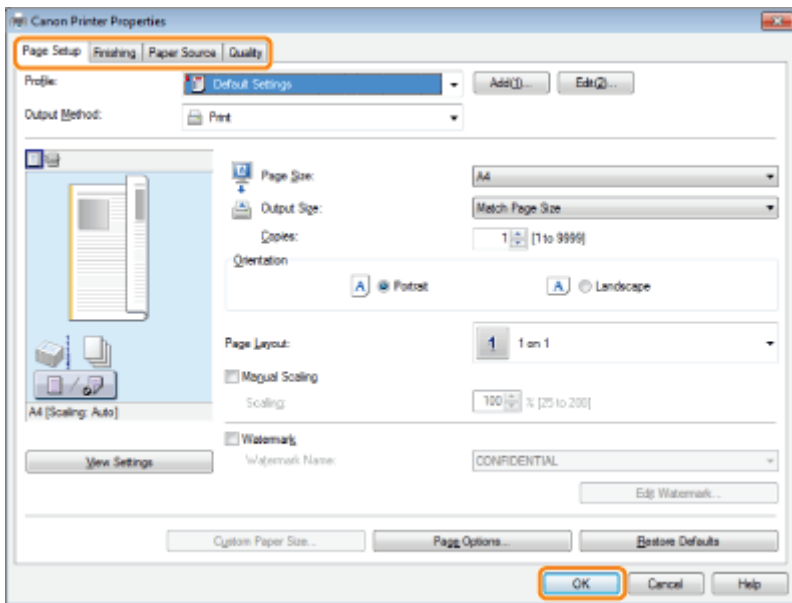

NOTE

- The default setting for [Print Style] in the [Finishing] sheet is [2-sided printing]. For details, see "[1-sided Printing and 2-sided Printing](#)."
- For information on available printing functions, see "[Printing Functions](#)" or the online help. (See "[Viewing the Online Help](#).")

4.

Click [OK].

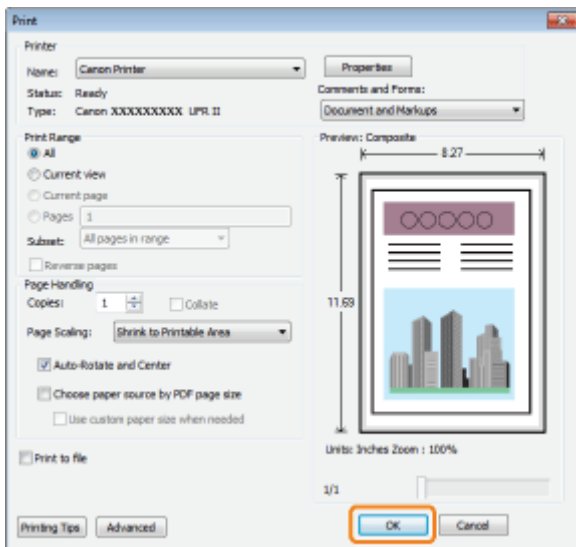

Printing begins.

NOTE

If a printer icon is displayed in the task tray at the bottom right of your computer monitor, you can stop printing from your computer. Double-click the printer icon → click the name of the file you want to stop printing → click [Document] → [Cancel].

Configuring the Print Settings Beforehand

04L9-04J

This section describes how to access the printer setup screen from [Control Panel] and how to configure the printing function settings beforehand.

The printer whose settings you have configured will print with those settings every time.

When printing, you can change these settings beforehand whenever required. To change the settings, configure them in the [Print] dialog box from the application.

IMPORTANT

To change the default print settings, you must log on to your computer as a member of the Administrators or Power Users group.

1.

Open the printer folder.

❖ "Basic Operations/Various Information for Windows"

2.

Right-click the icon of the printer whose settings you want to specify → click [Printing Preferences] (or [Printing preferences]).

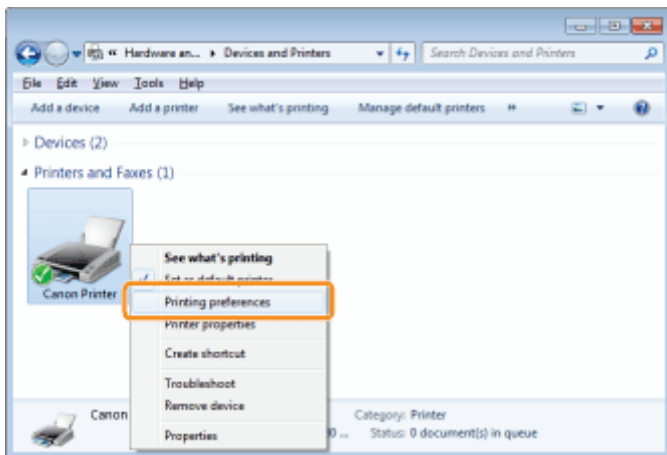

3.

Specify the desired settings in the printer driver screen → click [OK].

Click the tabs for the [Page Setup], [Finishing], [Paper Source], and [Quality] sheets, and then specify the desired items.

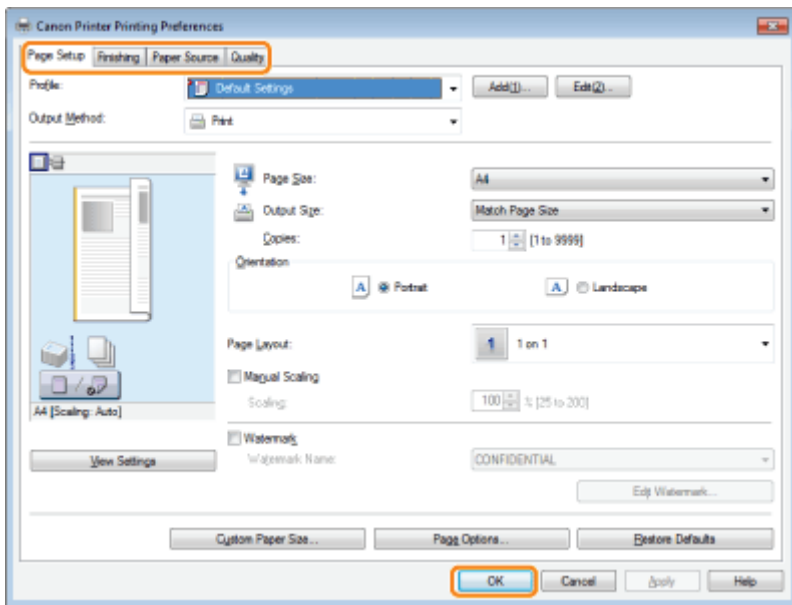

NOTE

For information on available printing functions, see "[Printing Functions](#)" or the online help. (See "[Viewing the Online Help](#).")

Setting the Printer Options

04L9-04K

Before printing, you need to set up the printer configuration in order to use the functions of printer options (such as paper feed options, paper output options, etc.) attached to and installed in the machine.

The printer configuration can be set up automatically while installing the driver. If the machine cannot be configured during the installation, follow the procedure below.

IMPORTANT

To configure the printer option settings, you must log on to your computer as a member of the Administrators or Power Users group.

1.

Open the printer folder.

❖ "Basic Operations/Various Information for Windows"

2.

Right-click the icon of the printer whose settings you want to specify → click [Properties] (or [Printer properties]).

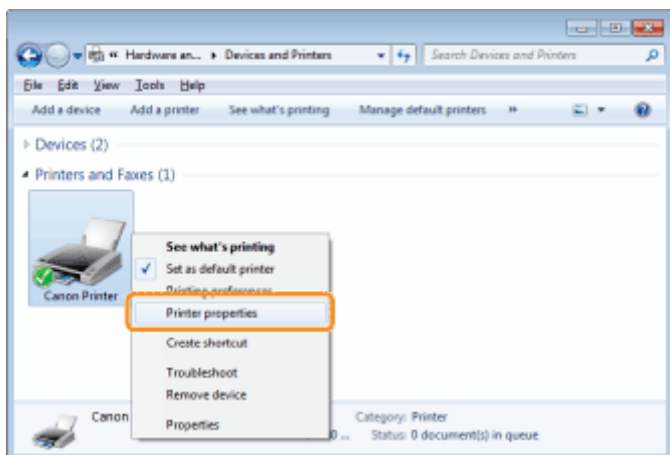

3.

Click [Device Settings] → [Get Device Status].

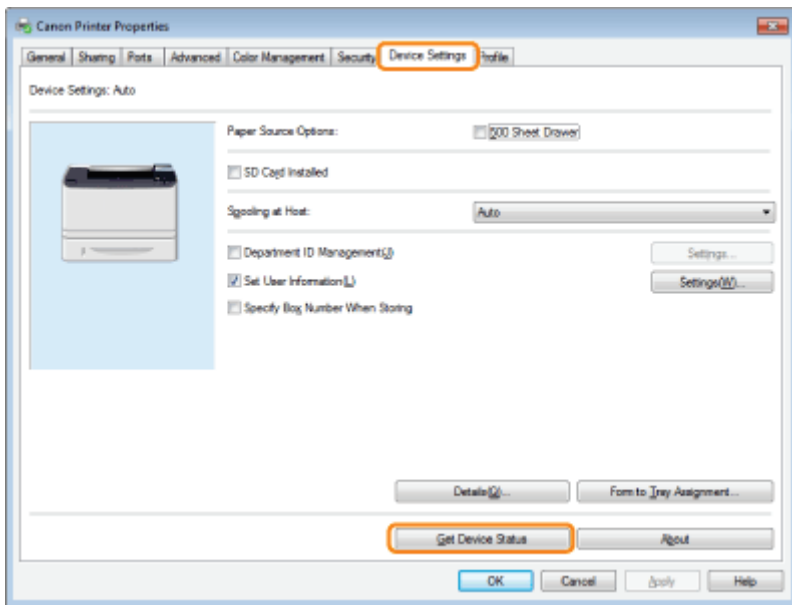

4.

Confirm the settings such as paper source options and output options → click [OK].

NOTE

- If the information request returns an error message, you need to configure the settings (such as paper feed options, paper output options, etc.) manually.
- If the printer and computer are connected via USB or a WSD (Web Services on Devices) port, the [Get Device Status] function is unavailable. You need to configure the settings manually.

Viewing the Online Help

04L9-04L

You can display the online help by clicking [Help] on the printer driver screen.

The online help includes additional information about each printing option. If the e-Manual does not provide the information you need, see the online help.

1.

Click [Help].

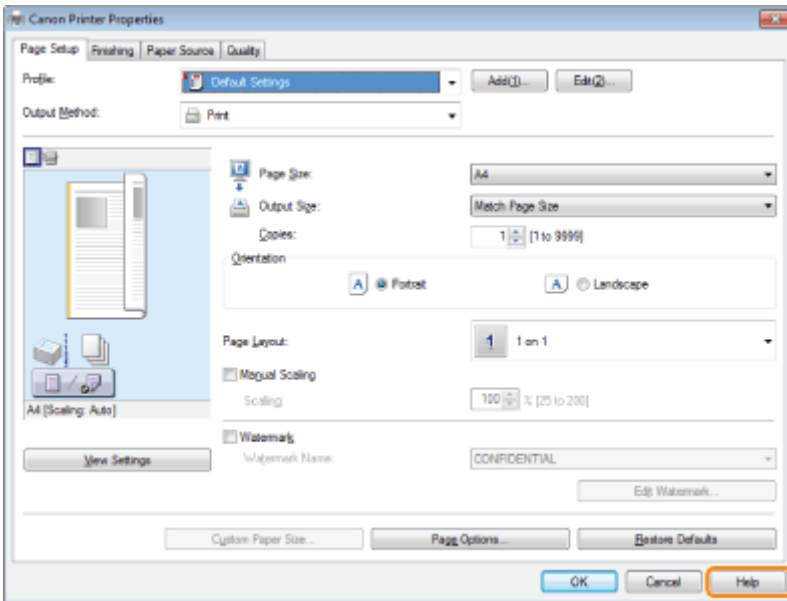

The online help is displayed.

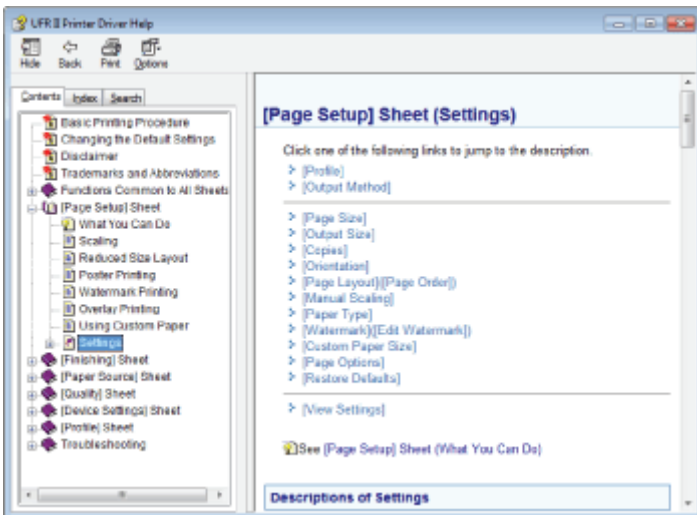

Topic pane (right side): Displays the description of the information.

Navigation pane (left side): Click [Contents] / [Search] to search for information.

Printing Functions

04L9-04R

This section explains printing functions which can be configured in the printer driver screen.

- ❖ Common Functions
- ❖ [Page Setup] Sheet
- ❖ [Finishing] Sheet
- ❖ [Paper Source] Sheet
- ❖ [Quality] Sheet
- ❖ [Device Settings] Sheet

 **NOTE**

The items displayed in the printer driver screen and available functions differ according to the printer model you are using.

Common Functions

04L9-045

The following functions are common to the [Page Setup], [Finishing], [Paper Source], and [Quality] sheets.

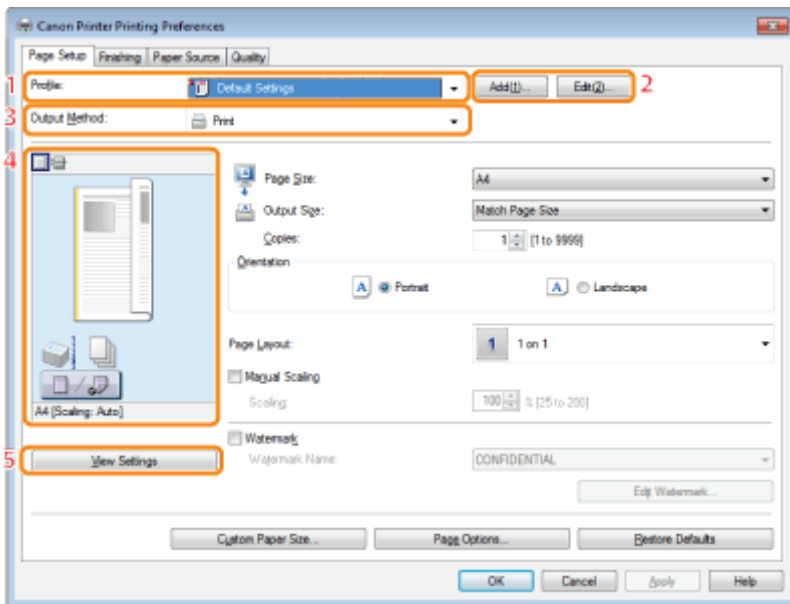

<p>1.Profiles</p>	<p>You can select a profile to conveniently repeat the same print settings (see "Selecting a Profile for Printing").</p>	<p>2.Adding/Editing Profiles</p>	<p>You can add and edit profile settings.</p>
<p>3.Changing the Output Method</p>	<p>You can change output methods. Example: [Edit and Preview]: Combines multiple sets of print data and configures print settings for the combined data (see "Combining and Printing Multiple Files").</p>	<p>4.Preview</p>	<p>The settings configured in each sheet are displayed in the preview.</p>
<p>5.Verifying Settings</p>	<p>You can verify the settings specified in each sheet.</p>		





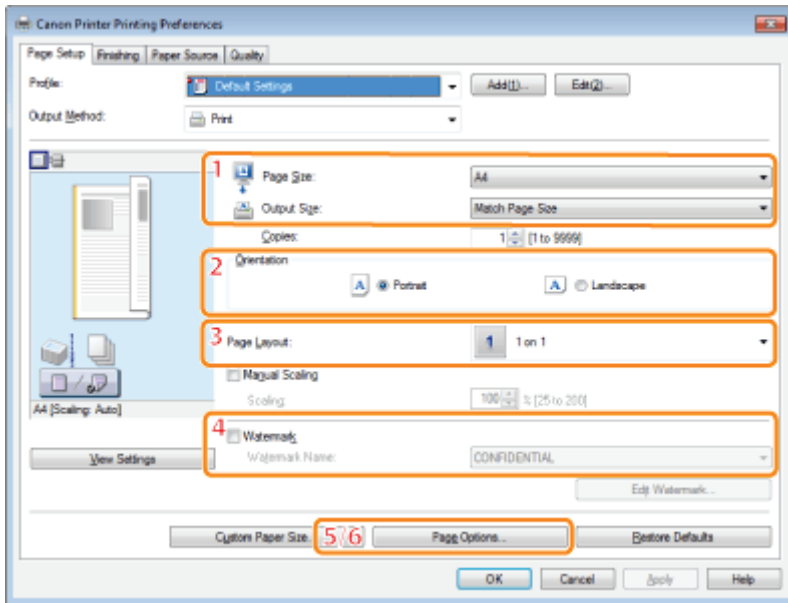

NOTE

For instructions on how to display the printer driver screen, see "[Printing with the Printer Driver](#)" or "[Configuring the Print Settings Beforehand](#)."

[Page Setup] Sheet

04L9-04U





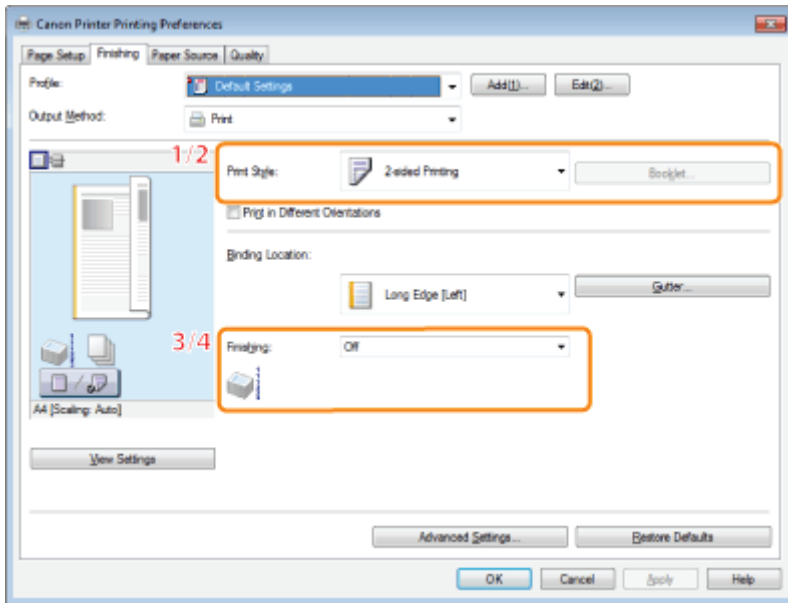

<p>1.Output Paper Size</p> 	<p>Enables you to select the paper size actually output from the printer (see "Scaling Documents").</p>	<p>2.Print Direction</p> 	<p>Sets the print direction relative to the orientation of the paper.</p>
<p>3.Page Layout</p> 	<p>Prints multiple pages arranged on one sheet of paper (see "Printing Multiple Pages on One Sheet").</p>	<p>4.Watermark</p> 	<p>Prints pages with a watermark (such as "COPY") superimposed on the document (see "Watermark Printing").</p>
<p>5.Page Border</p> 	<p>Prints each page with a border.</p>	<p>6.Header/Footer</p> 	<p>Prints pages with headers and/or footers with the date, page number, etc.</p>

NOTE

For instructions on how to display the printer driver screen, see "[Printing with the Printer Driver](#)" or "[Configuring the Print Settings Beforehand](#)."



<p>1.1-sided/2-sided Printing</p> 	<p>Prints on one or both sides of the paper. The default setting for [Print Style] is [2-sided printing].</p>	<p>2.Booklet Printing</p> 	<p>Prints pages in a sequence that allows them to be folded and grouped into a booklet when output (see "Booklet Printing").</p>
<p>3.Collating</p> 	<p>When printing multiple sets of copies, outputs each set separately in page order.</p>	<p>4.Grouping</p> 	<p>When printing multiple sets of copies, outputs the pages in groups according to their page numbers.</p>

NOTE

For instructions on how to display the printer driver screen, see "[Printing with the Printer Driver](#)" or "[Configuring the Print Settings Beforehand](#)."

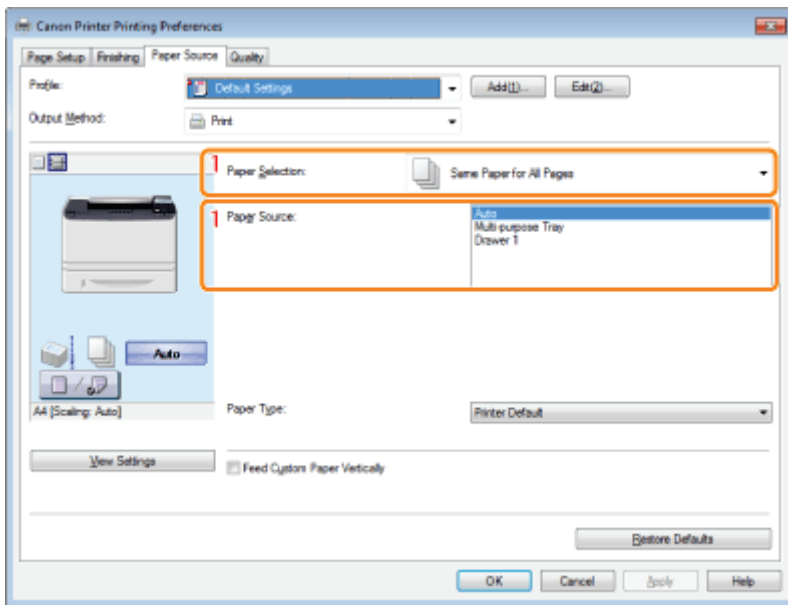

1. Specifying the Paper



When you want to print on a specific type of paper, specify the paper source containing the paper, or the paper type.

NOTE

For instructions on how to display the printer driver screen, see ["Printing with the Printer Driver"](#) or ["Configuring the Print Settings Beforehand."](#)

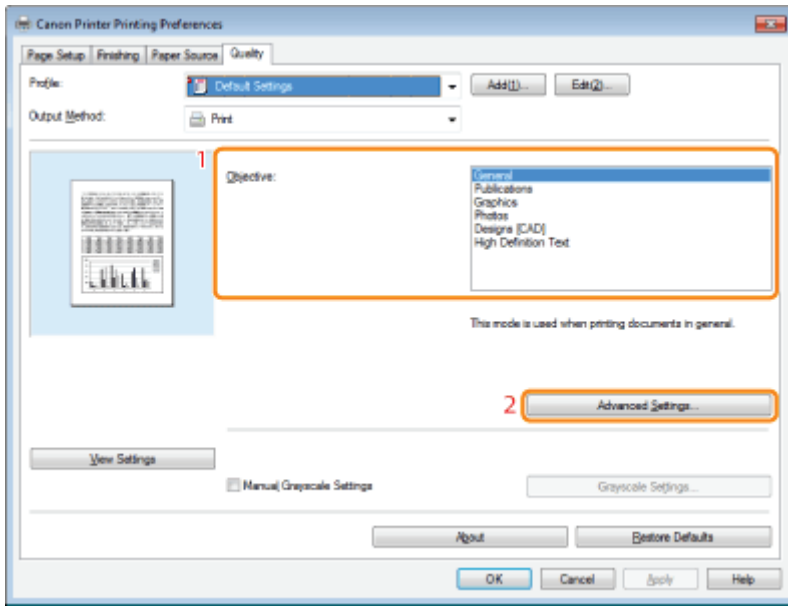

1.Objective

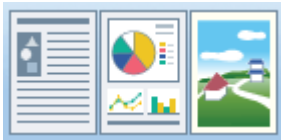

Enables you to conveniently select the appropriate settings for the current content.

2.Toner Reduction



Prints with a reduced amount of toner.

NOTE

For instructions on how to display the printer driver screen, see ["Printing with the Printer Driver"](#) or ["Configuring the Print Settings Beforehand."](#)

[Device Settings] Sheet

04L9-050

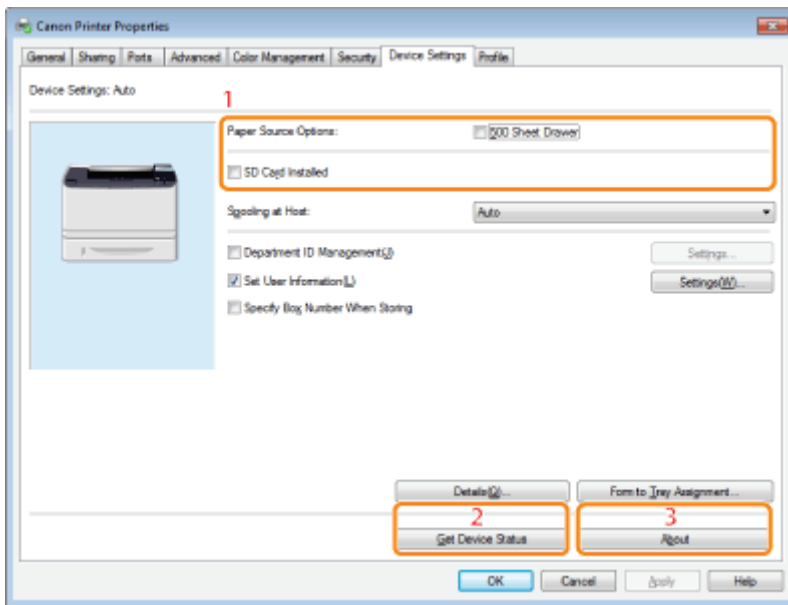

1.Set Options	You can set the printer options (such as paper feed options, paper output options, etc.) attached to the machine.	2.Obtain Device Information	You can obtain device information and update the settings displayed in the sheet (see " Setting the Printer Options ").
3.Display Version Information	You can display version information.		

NOTE

For instructions on how to display the printer properties dialog box, see "[Setting the Printer Options](#)."

Scaling Documents

04L9-051

You can enlarge or reduce documents to match the output paper size.

There are two methods for scaling a document: select the output size of the document to scale it automatically, or specify the scaling value manually.

1.

Click [Page Setup].

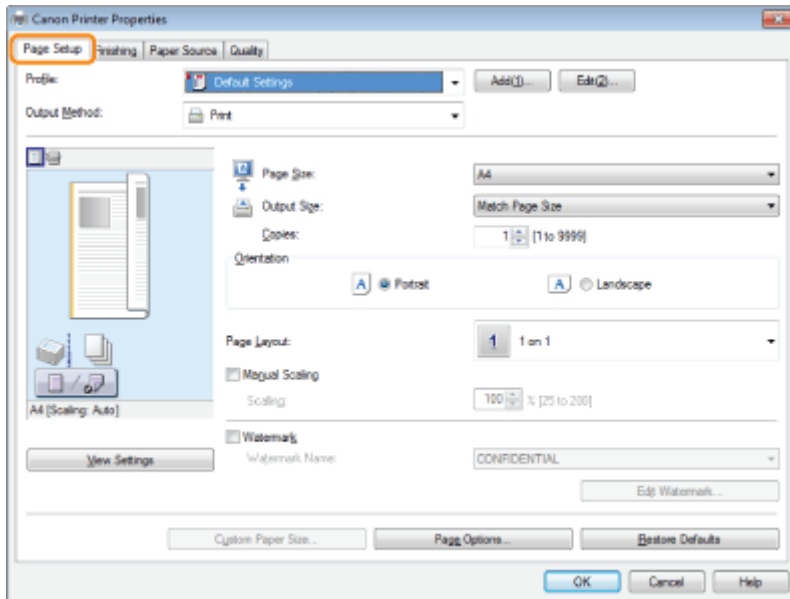

For instructions on how to display the printer driver screen, see "[Printing with the Printer Driver](#)" or "[Configuring the Print Settings Beforehand](#)."

2.

Select page size of the document you created in the application from [Page Size].

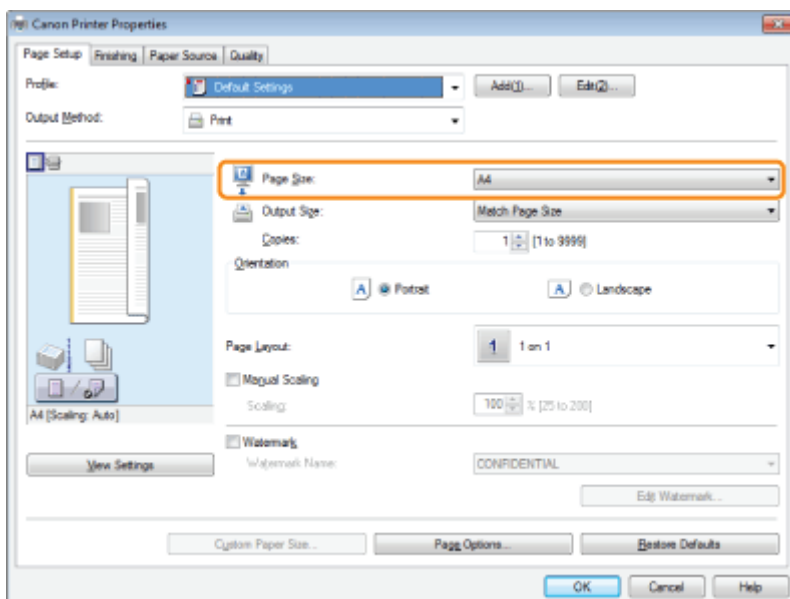

3.

Select output size of the document from [Output Size].

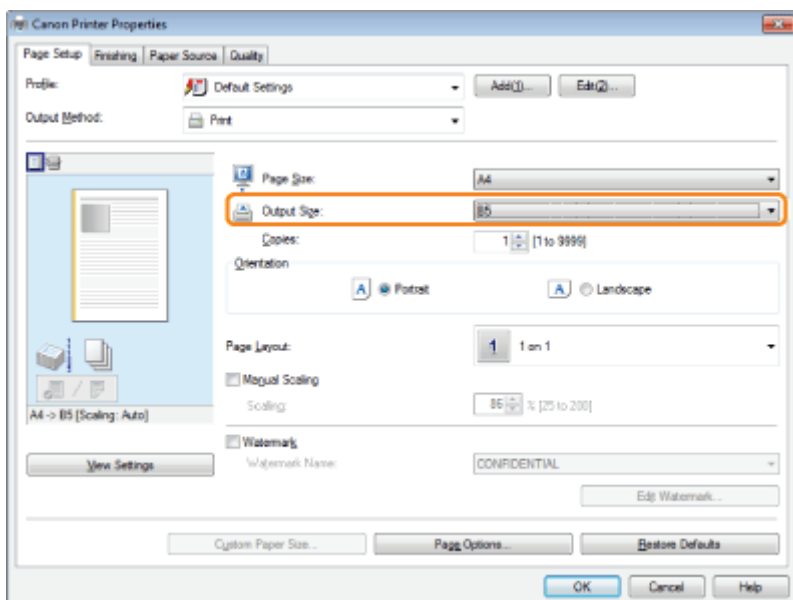

The document is scaled automatically according to the settings made in [Page Size] and [Output Size].

4.

If you want to increase or decrease the magnification manually, select [Manual Scaling] → specify the scaling ratio for [Scaling].



5.

Click [OK].

NOTE

- Depending on the selected page size and printer model you are using, you may not be able to magnify the document.
- Depending on the printer model you are using, you may not be able to magnify the document to the optimum ratio for the selected page size.
- The display may vary according to the operating system, as well as the type and version of the printer driver.

Printing Multiple Pages on One Sheet

04L9-052

Multiple pages can be printed on one sheet of paper.

1.

Click [Page Setup].

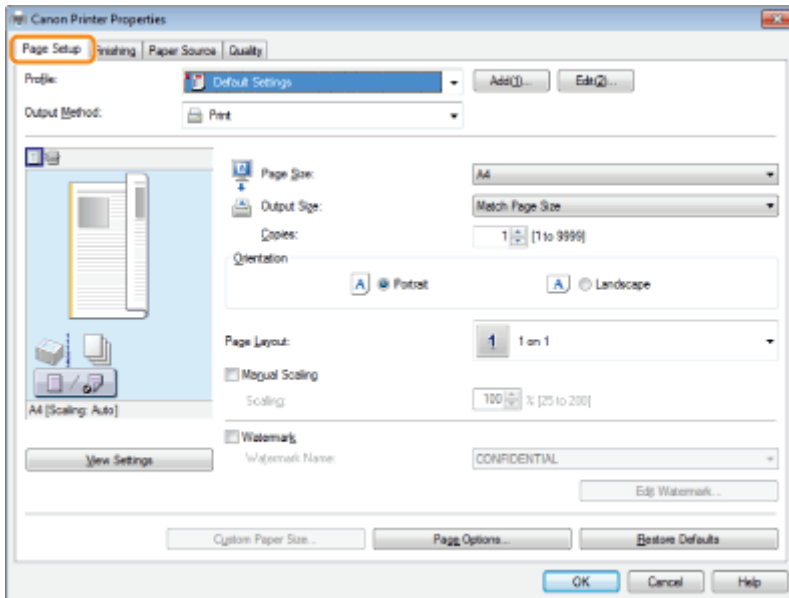

For instructions on how to display the printer driver screen, see "Printing with the Printer Driver" or "Configuring the Print Settings Beforehand."

2.

Select [N in 1] from [Page Layout] (where "N" is the number of pages you want to print on the sheet).

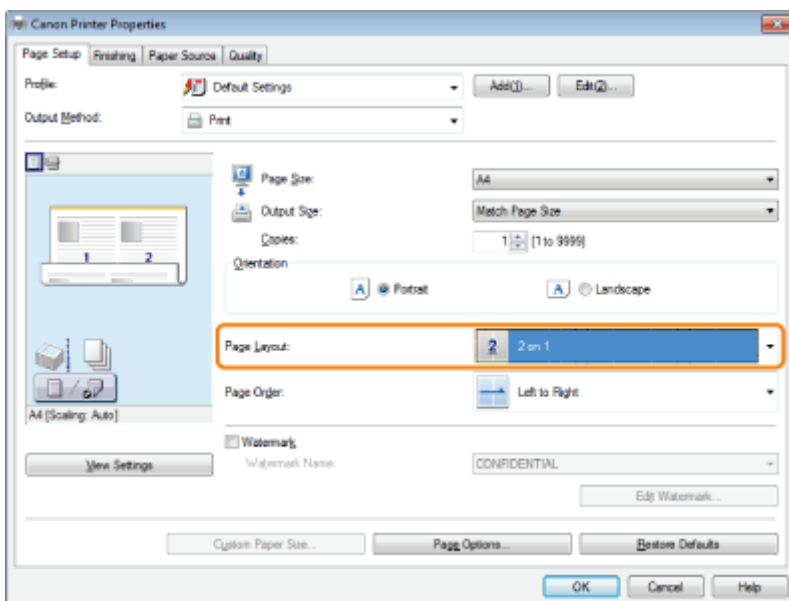

Note

If you cannot select the options for [Page Layout], display the [Device Settings] sheet, and then select [Auto] or [Enabled] from [Spooling at Host]. For instructions on how to display the [Device Settings] sheet, see "Setting the Printer Options."

3.

Select the page order from [Page Order].

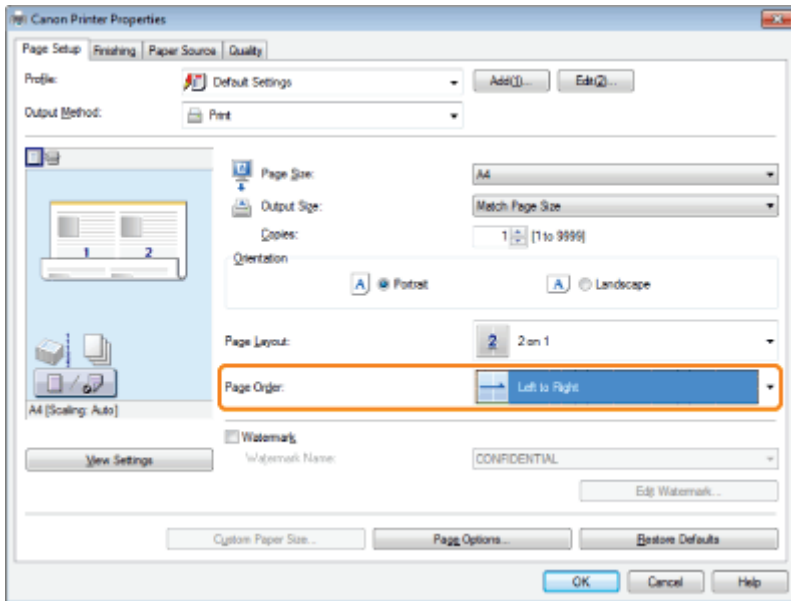

The output image is displayed in the preview area.

4.

Click [OK].

NOTE

- You cannot enlarge and reduce manually when using this function.
- Although there may be a function for printing multiple copies depending on the application you are using, do not use it together with this function. If you do, printing may not be executed correctly.
- The display may vary according to the operating system, as well as the type and version of the printer driver.

1-sided Printing and 2-sided Printing

04L9-053

You can select whether to print on one side or both sides of each sheet of paper. The default setting for [Print Style] is [2-sided printing].

Paper Type	Paper Size
Plain paper (60 to 90 g/m ²) Heavy paper (91 to 120 g/m ²)	A4, Legal, Letter

Before performing 2-sided printing, see "Attention (1-sided Printing and 2-sided Printing)."

IMPORTANT

Precautions when performing 2-sided printing

- Do not touch the paper during 2-sided printing until it is completely output. The paper is first partially output after the front side is printed, and then it is fed again to be printed on the back side.
- Be sure to close the output selection cover before performing 2-sided printing.

➤ "Paper Loading and Output"

Printing on the back side of paper whose front side is already printed

This printer enables you to perform 2-sided printing by manually inserting the back side of the paper* whose front side was previously printed even if the paper cannot be used for 2-sided printing.

When printing on the back side of paper whose front side was previously printed, flatten out any curled paper and load one sheet of paper at a time in the multi-purpose tray.

* This is only for paper that has been printed using this printer. Also, you cannot print again on the same side of the paper that was printed before.

* If you are using A5 paper, the back side may not be printed correctly.

1.

Set the paper size switch lever to the appropriate position according to the paper size for 2-sided printing.

† If the lever is not set to the appropriate position, this may result in paper being misfed or paper jams.

1. Open the duplex unit cover.

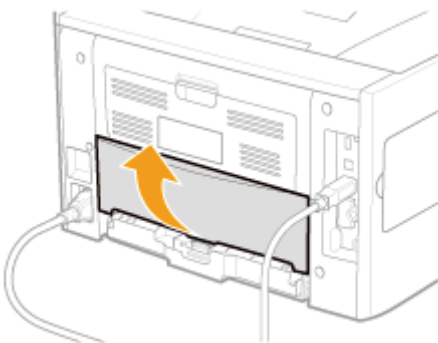

2. Set the blue paper size switch lever (A) to the appropriate position.

- A4: **Pull the lever toward you.**
- Letter or Legal: **Push the lever into the printer.**

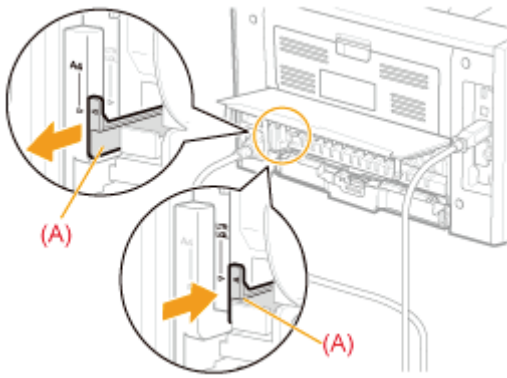

3. Close the duplex unit cover.

2.

Click [Finishing].

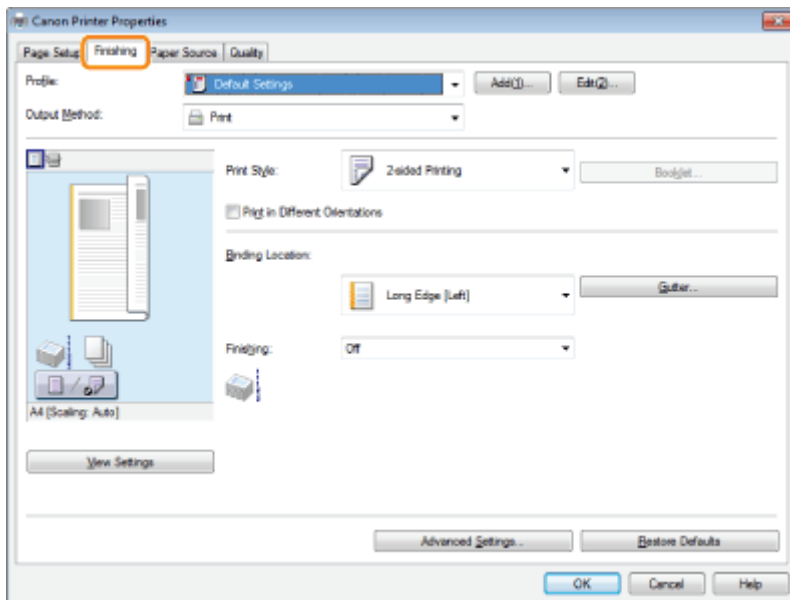

For instructions on how to display the printer driver screen, see ["Printing with the Printer Driver"](#) or ["Configuring the Print Settings Beforehand."](#)

3.

Select [1-sided Printing] or [2-sided Printing] from [Print Style].

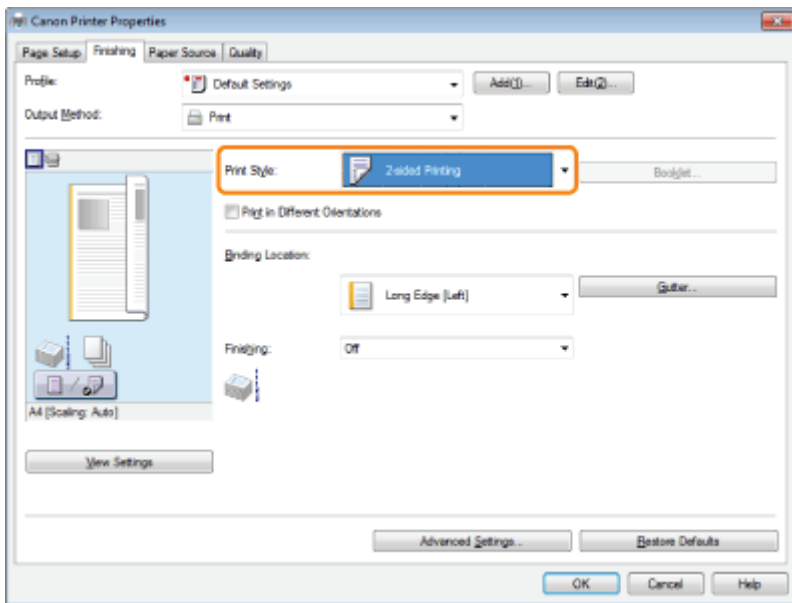

4.

Select the binding edge from [Binding Location].

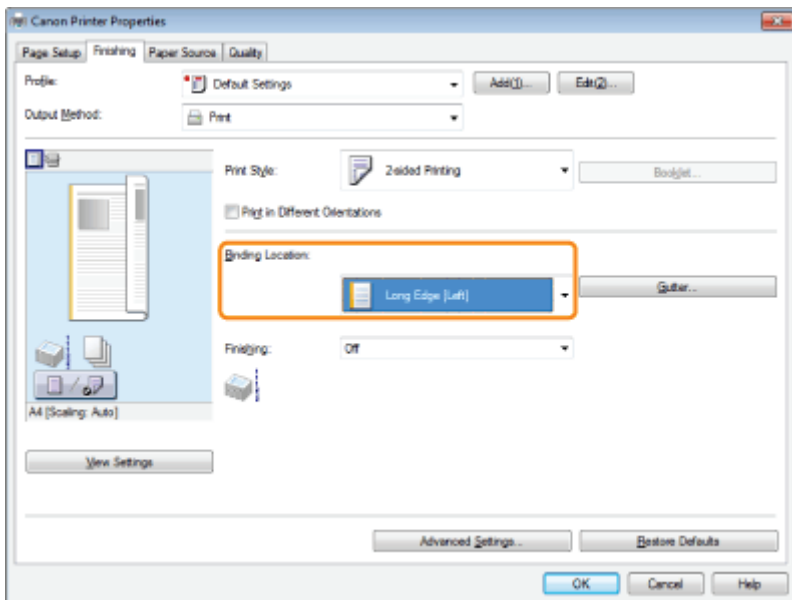

The output image is displayed in the preview area.

5.

Click [OK].

Note

- The display may vary according to the operating system, as well as the type and version of the printer driver.

Attention (1-sided Printing and 2-sided Printing)

04L9-054

NOTE



Paper loading orientation

On 2-sided printing, the back side of the paper is printed first, therefore the paper should be loaded in the opposite orientation to that for 1-sided printing.

If printing on such paper with letterheads, in which faces and directional orientations are specified, see "[Paper Loading Orientation](#)" and load the paper in the proper orientation.

In the case where the last page is 1-sided printing

In cases such as where the last page for the 2-sided printing is 1-sided printing, specifying the following setting allows you to print faster than normal 2-sided printing.

1. Press [] ( : Settings).
2. Select [Layout] using [▲] and [▼], and then press [OK].
3. Select [Alternative Method] using [▲] and [▼], and then press [OK].
4. Select [On] using [▲] and [▼], and then press [OK].

However, when performing 2-sided printing on punched paper or previously printed paper, the orientation or printing surface of the last page may differ from other pages. In this case, set to [Off].

You can print two pages of a document on each side of each sheet, and then fold the sheets in half to create a booklet.

Paper Type	Paper Size
Plain paper (60 to 90 g/m ²) Heavy paper (91 to 120 g/m ²)	A4, Legal, Letter

IMPORTANT

Precautions when performing booklet printing

- Do not touch the paper during booklet printing until it is completely output. The paper is first partially output after the front side is printed, and then it is fed again to be printed on the back side.
- Be sure to close the output selection cover before performing booklet printing.

➤ ["Paper Loading and Output"](#)

1.

Set the paper size switch lever to the appropriate position according to the paper size for 2-sided printing.

† If the lever is not set to the appropriate position, this may result in paper being misfed or paper jams.

1. Open the duplex unit cover.

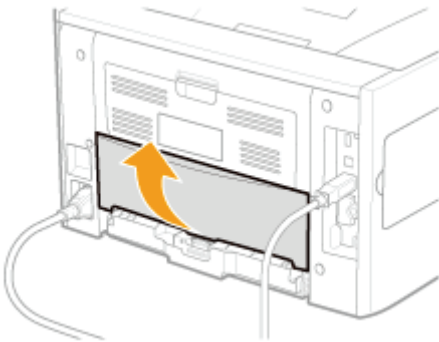

2. Set the blue paper size switch lever (A) to the appropriate position.

- A4: **Pull the lever toward you.**
- Letter or Legal: **Push the lever into the printer.**

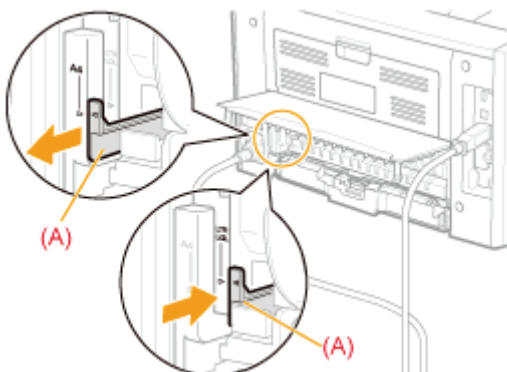

3. Close the duplex unit cover.

2.

Click **[Finishing]**.

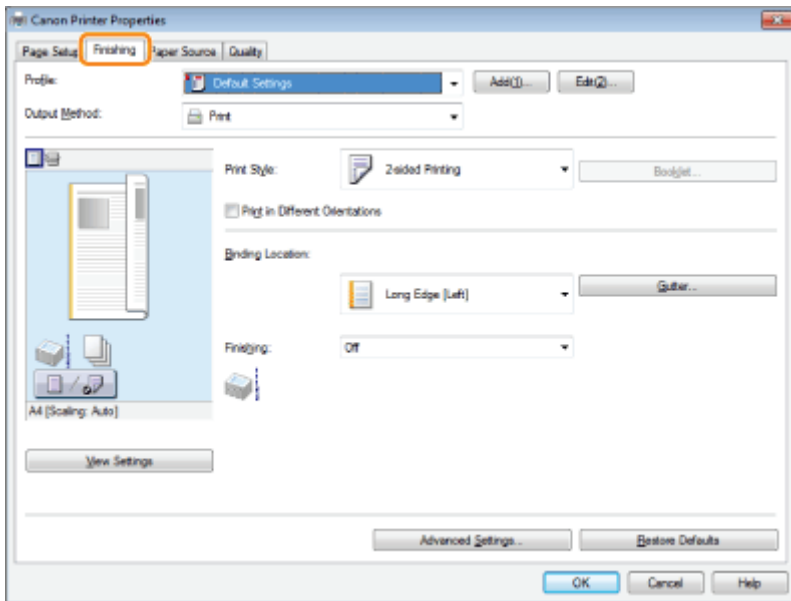

For instructions on how to display the printer driver screen, see ["Printing with the Printer Driver"](#) or ["Configuring the Print Settings Beforehand."](#)

3.

Select **[Booklet Printing]** from **[Print Style]**.

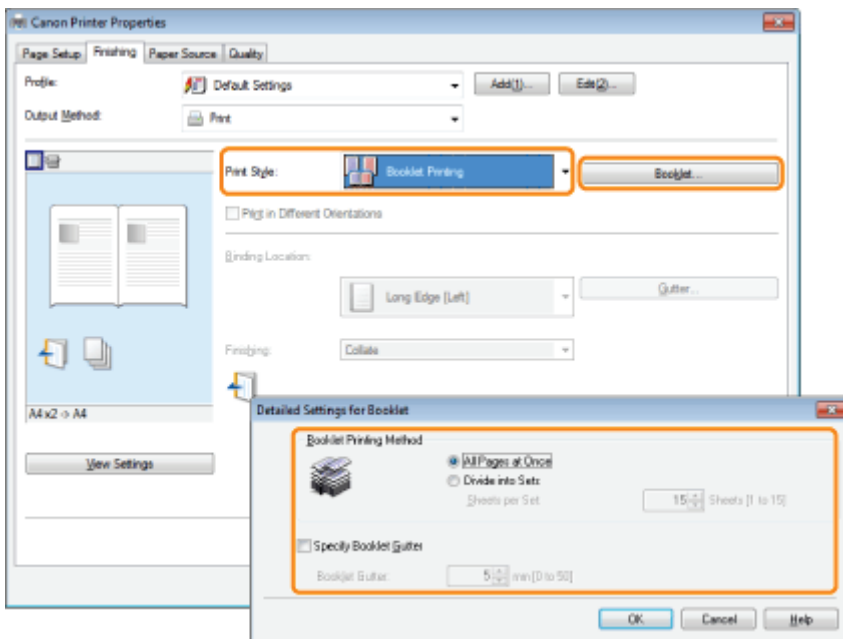

You can also configure detailed settings such as the opening direction and gutter width for booklet printing in the [Detailed Settings for Booklet] dialog box, displayed by clicking [Booklet].

The output image is displayed in the preview area.

NOTE

For details about the various settings in the [Detailed Settings for Booklet] dialog box, view the online help. (See ["Viewing the Online Help."](#))

4.

Click [OK].

 **NOTE**

- You cannot specify the [Finishing] options in the [Finishing] sheet when performing Booklet Printing.
- The display may vary according to the operating system, as well as the type and version of the printer driver.

Poster Printing

04L9-056

You can enlarge a one-page image and print it over multiple pages. You can then glue the printed pages together to create a poster.

1.

Click **[Page Setup]**.

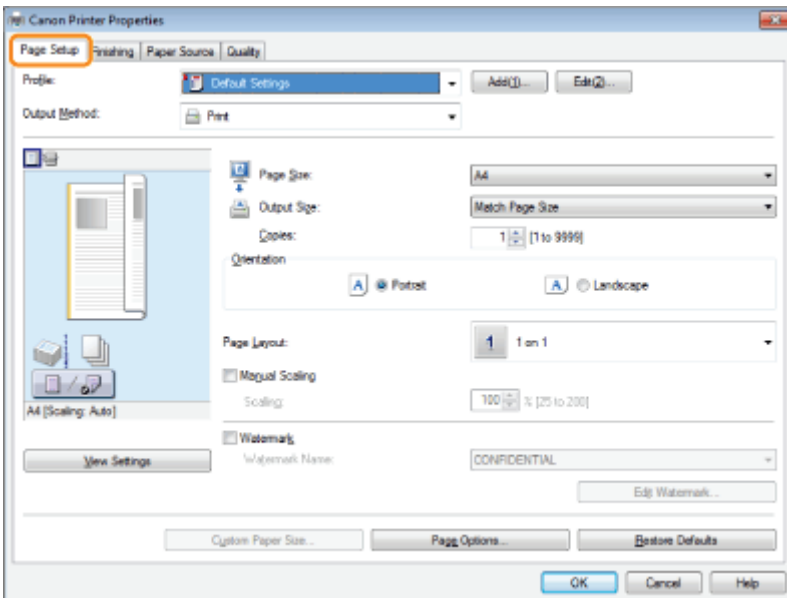

For instructions on how to display the printer driver screen, see ["Printing with the Printer Driver"](#) or ["Configuring the Print Settings Beforehand."](#)

2.

Select **[Poster [N x N]] (N = 2, 3, or 4)** from **[Page Layout]**.

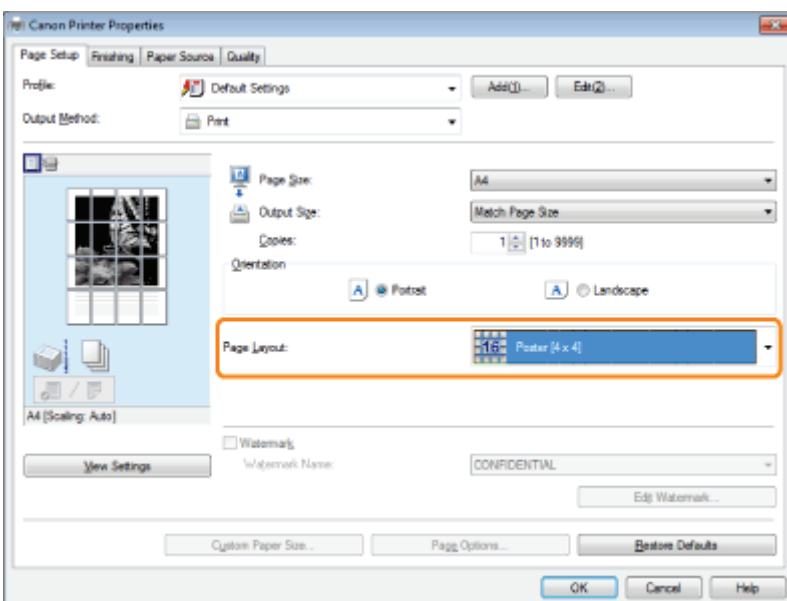

The output image is displayed in the preview area.

NOTE

If you cannot select the options for [Page Layout], display the [Device Settings] sheet, and then select [Auto] or [Enabled]

from [Spooling at Host]. For instructions on how to display the [Device Settings] sheet, see "[Setting the Printer Options.](#)"

3.

Click [OK].

NOTE

- When outputting the pages face-up, the print sequence for the pages (the sheets into which the image is divided) starts from the top left proceeds to the right. When outputting the pages face-down, the sequence starts from the bottom right and proceeds to the left.
- 2-sided printing is not supported when performing poster printing. Switch to 1-sided printing.
- ["1-sided Printing and 2-sided Printing"](#)
- Poster printing cannot be used together with "[Watermark Printing](#)", "[Scaling Documents](#)", or "[Printing Multiple Pages on One Sheet.](#)"
- The display may vary according to the operating system, as well as the type and version of the printer driver.

Watermark Printing

04L9-057

You can print a watermark (such as "CONFIDENTIAL" or "COPY") on a document created using an application. You can register the customized watermark other than the various predefined watermarks.

1.

Click [Page Setup].

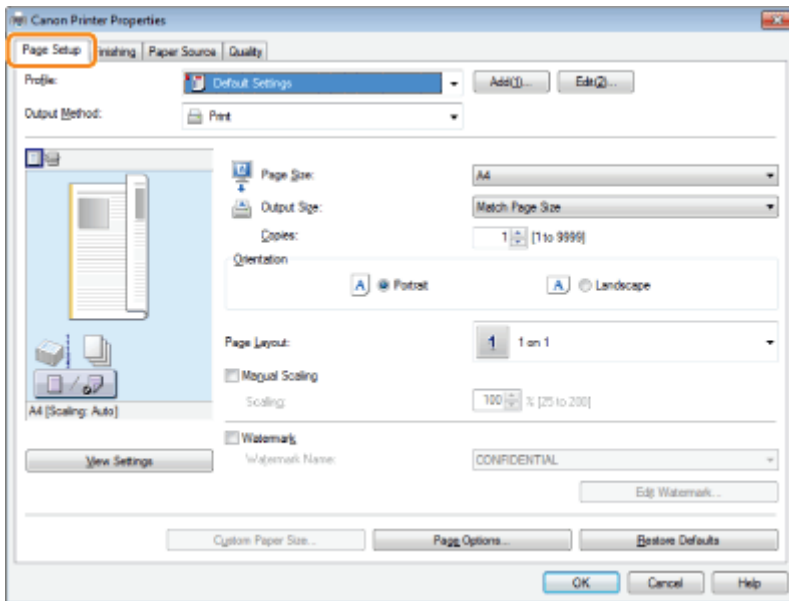

For instructions on how to display the printer driver screen, see "Printing with the Printer Driver" or "Configuring the Print Settings Beforehand."

2.

Select [Watermark] → select a watermark for printing.

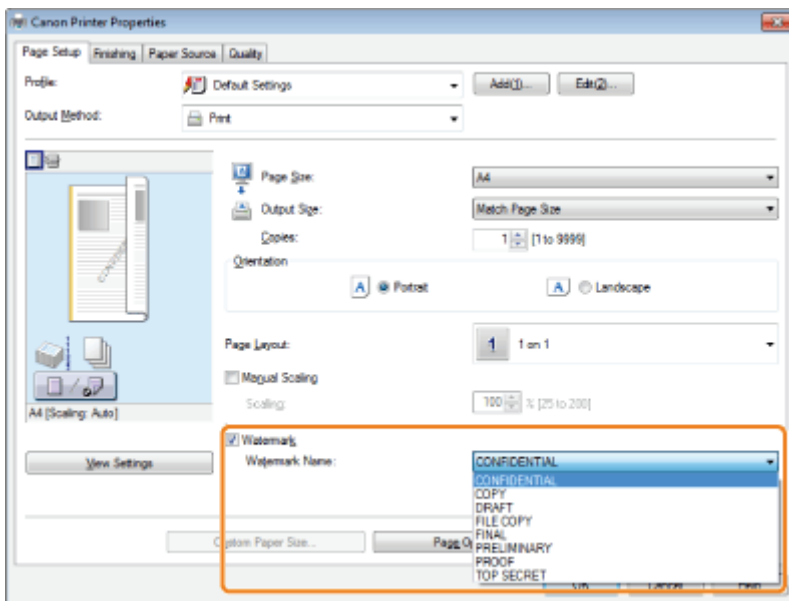

The output image is displayed in the preview area.

NOTE

By clicking [Edit Watermark], you can create and register new watermarks. For details, view the online help (see "Viewing

the Online Help").

3.

Click [OK].

NOTE

- You can register up to 50 watermarks, not including the watermarks already provided.
- The display may vary according to the operating system, as well as the type and version of the printer driver.

Combining and Printing Multiple Files

04L9-059

You can combine two or more files created using different applications and edit and print them as a single file.

1.

Select [Edit and Preview] from [Output Method].

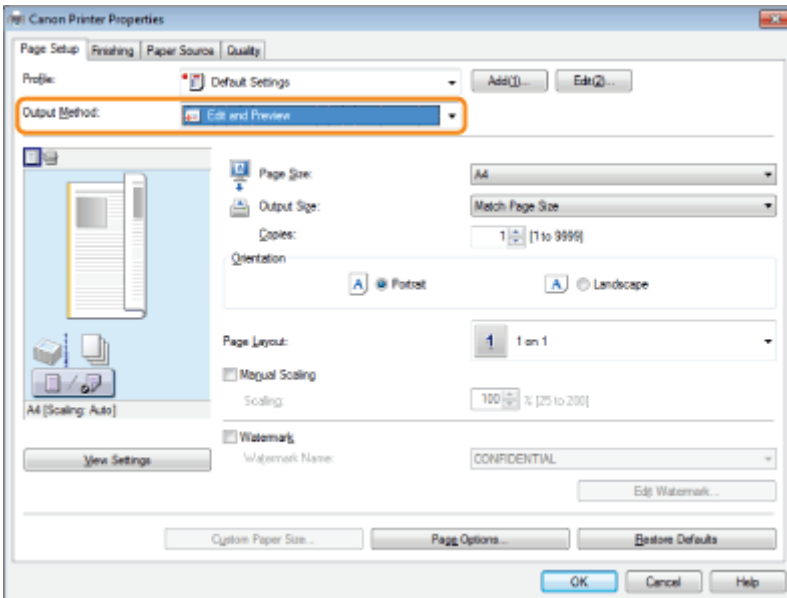

For instructions on how to display the printer driver screen, see "[Printing with the Printer Driver](#)" or "[Configuring the Print Settings Beforehand](#)."

2.

Specify the desired settings in the printer setup screen → click [OK].

Click the tabs for the [Page Setup], [Finishing], [Paper Source], and [Quality] sheets, and then specify the desired items.

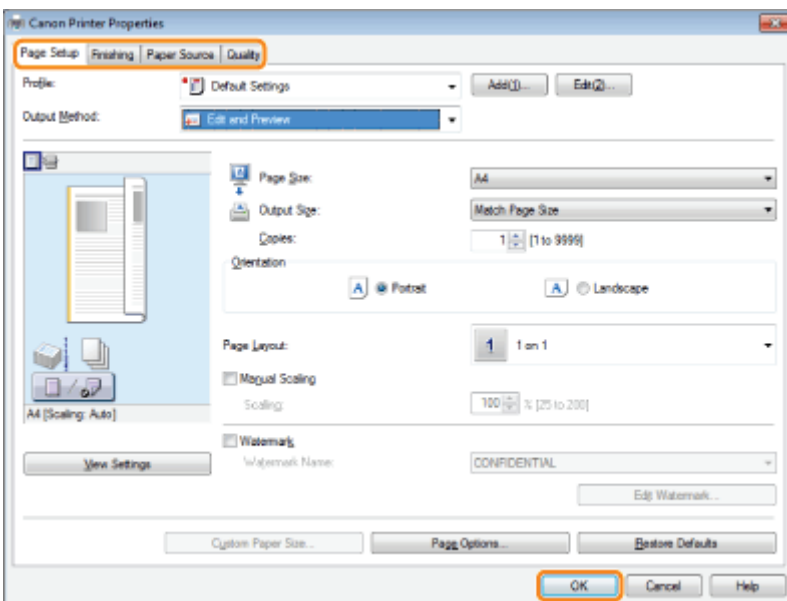

NOTE

For information on available printing functions, see "[Printing Functions](#)" or the online help. (See "[Viewing the Online Help](#).")

3.

Click **[OK]** in the **[Print]** dialog box.

The [Canon PageComposer] dialog box is displayed.

4.

For each file you want to combine, repeat **Steps 1 to 3**.

5.

Select the files you want to combine from **[Document Name]** → click [] (**Combine Documents**).

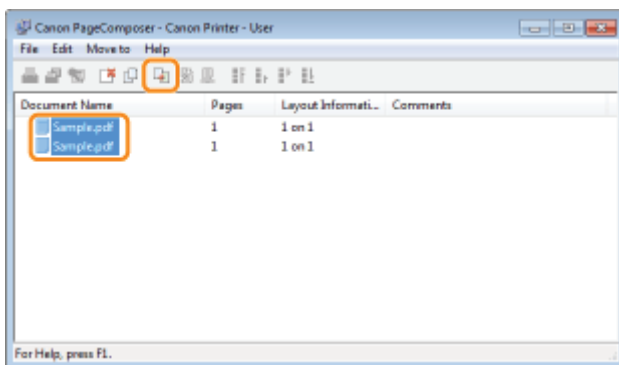

6.

If you want to edit the print settings of the combined file, click **[Print Settings]** → specify the desired settings → click **[Combine]**.

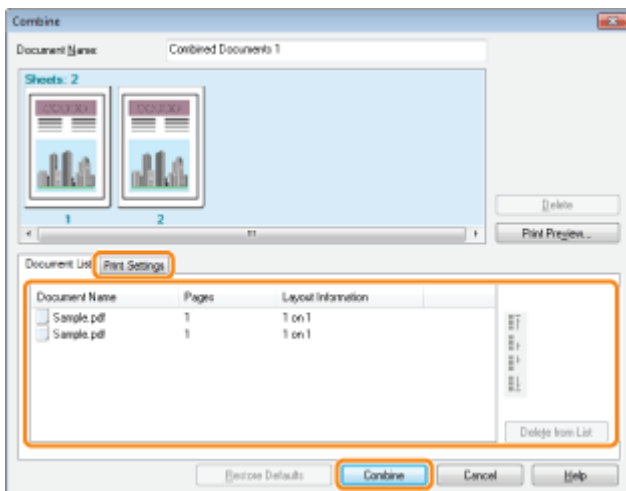

7.

Select the combine file you want to print from **[Document Name]** → click [] (**Print**).

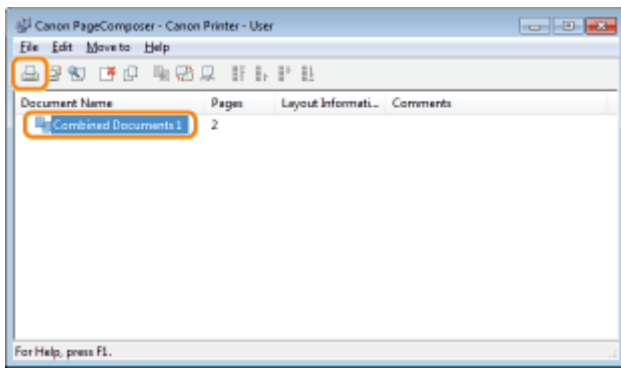

 **NOTE**

- For details on settings of Canon PageComposer, see the Canon PageComposer online help.
- The display may vary according to the operating system, as well as the type and version of the printer driver.

Selecting a Profile for Printing

04L9-05A

Combinations of printer driver settings corresponding to a variety of printing purposes are provided with the printer driver as "profiles." This enables you to print documents according to a desired objective by simply selecting a profile from the [Profile] list.

You can register the customized profiles other than the various predefined profiles. (See "[Registering a Profile for Printing](#).")

1.

Select a profile from the [Profile] list according to your objective.

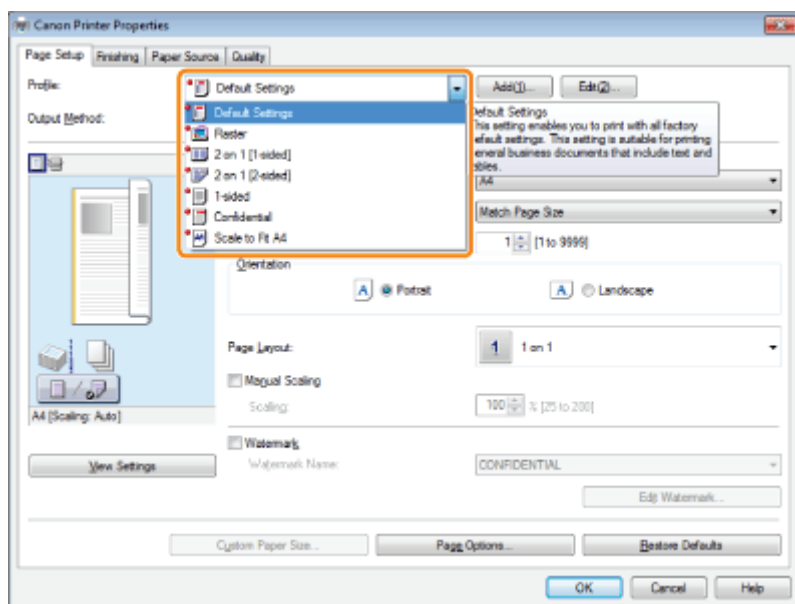

For instructions on how to display the printer driver screen, see "[Printing with the Printer Driver](#)" or "[Configuring the Print Settings Beforehand](#)."

The output image is displayed in the preview area.

2.

Click [OK].

NOTE

- To select a profile, you need to select [Allow Profile Selection] in the [Profile] sheet of the printer properties dialog box. (See "[Configuring the Print Settings Beforehand](#).".) If you are using Windows 2000/Windows XP/Windows Server 2003, to change this setting, you need full control access for the device. Full control access is available for users who are registered as Administrators or Power Users in the Windows system settings.
- The display may vary according to the operating system, as well as the type and version of the printer driver.

Registering a Profile for Printing

04L9-05C

If you have registered frequently used settings as "profiles," you can apply the settings by simply selecting them from the [Profile] list.

1.

Specify the desired settings in the printer driver screen → click [Add].

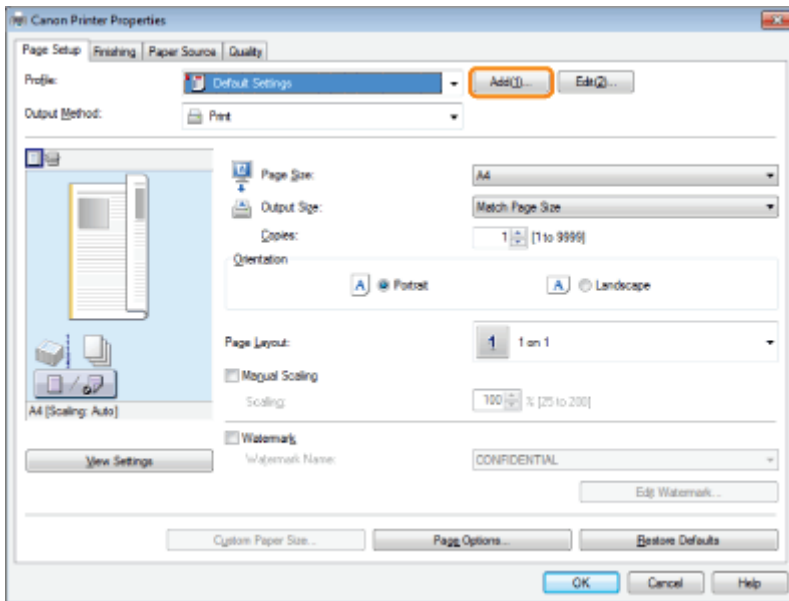

Click the tabs for the [Page Setup], [Finishing], [Paper Source], and [Quality] sheets, and then specify the desired items. For instructions on how to specify the print settings, see "[Printing with the Printer Driver](#)" or "[Configuring the Print Settings Beforehand](#)."

For information on available printing functions, see "[Printing Functions](#)" or the online help (see "[Viewing the Online Help](#)").

2.

Set [Name] and [Icon] → click [OK].

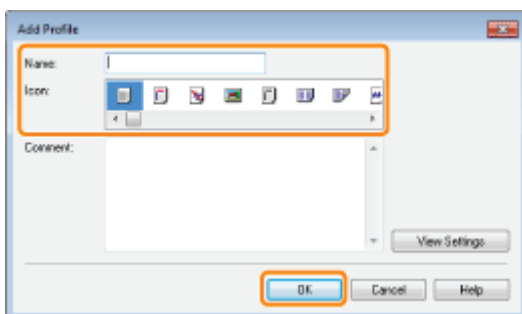

Enter additional information in [Comment] if necessary.

NOTE

- To edit or delete a profile, in the printer driver screen, click [Edit] at the right of [Profile]. However, pre-defined profiles cannot be modified.
- If you cannot select a profile, display the printer properties dialog box from [Control Panel], click the [Profile] tab, and then check whether [Allow Profile Selection] and [Allow Setting Addition] are selected. For details about how to display the printer properties dialog box, see "[Setting the Printer Options](#)."

The display may vary according to the operating system, as well as the type and version of the printer driver.

Printing from a Computer (Macintosh)

04L9-05E

▸ **Printing Fundamentals**

- Printing with the Printer Driver
- Configuring the Page Settings Beforehand
- Setting the Printer Options
- Viewing the Online Help
- Viewing the Driver Guide

▸ **Printing Functions**

- Common Functions
- [Layout] Preferences Pane
- [Finishing] Preferences Pane
- [Paper Source] Preferences Pane
- [Quality] Preferences Pane
- [Special Features] Preferences Pane

▸ **Scaling Documents**

▸ **Printing Multiple Pages on One Sheet**

▸ **1-sided Printing and 2-sided Printing**

▸ **Using [Presets] for Printing**

Printing Fundamentals

04L9-05F

This section explains the basic printing method using the printer driver, how to set the printer options, and how to display the online help.

- [Printing with the Printer Driver](#)
 - [Configuring the Page Settings Beforehand](#)
 - [Setting the Printer Options](#)
 - [Viewing the Online Help](#)
 - [Viewing the Driver Guide](#)
-

Printing with the Printer Driver

04L9-05H

This section explains the basic printing method using the printer driver.

NOTE

Printing methods may vary depending on the application you are using. For details, see the instruction manuals provided with the application.

1.

Select **[Page Setup]** from the **[File]** menu of the application.

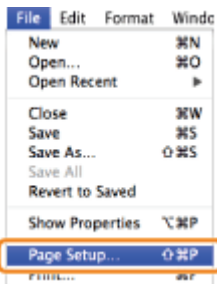

NOTE

In Mac OS X 10.5.x, the [Page Setup] dialog box may not be displayed, depending on the application you are using. If this is the case, you can specify the page size, page orientation, and scaling in the [Print] dialog box.

2.

Select **[Page Attributes]** from **[Settings]**.

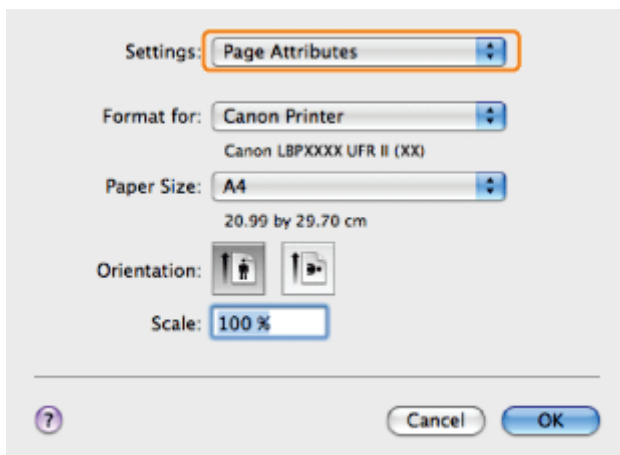

3.

Select your printer from **[Format for]** → set **[Paper Size]**, **[Orientation]**, and **[Scale]** as necessary → click **[OK]**.

4.

Select [Print] from the [File] menu.

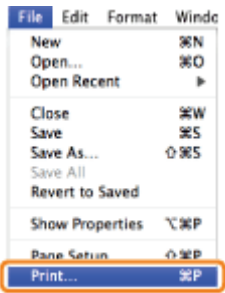

5.

Select your printer from [Printer] → set the number of copies, which pages to print, etc.

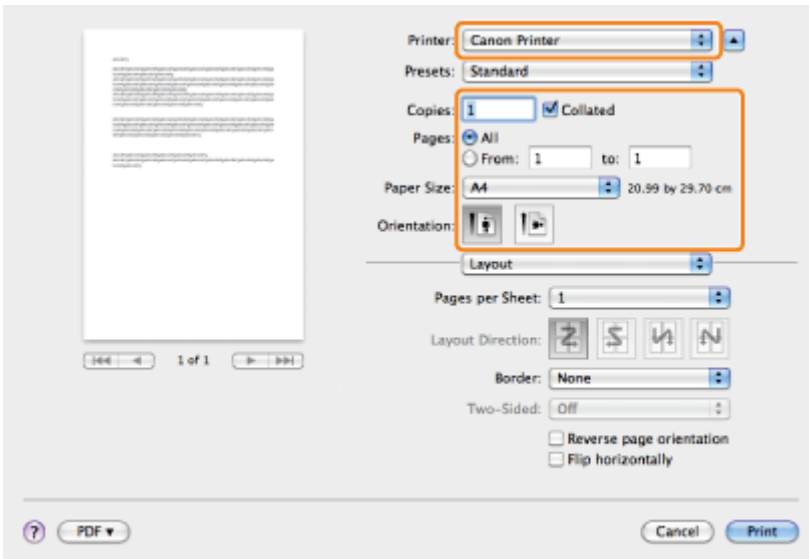

6.

Select the appropriate preferences panes, and configure the print settings.

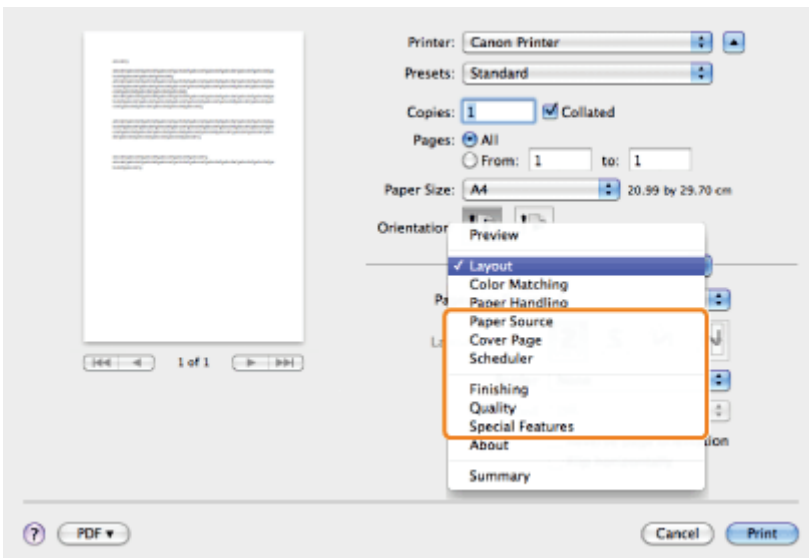

NOTE

If the machine you are using supports 2-sided printing, the default setting is 2-sided printing. If you want to print on one side of the paper, see "[1-sided/2-sided Printing](#)."

For information on available printing functions, see "[Printing Functions](#)" or the online help. (See "[Viewing the Driver Guide](#).")

7.

Click [Print].

Printing begins.

Configuring the Page Settings Beforehand

04L9-05J

The procedure for configuring the page settings prior to printing is as follows.

1.

Select **[Page Setup]** from **[File]** menu of the application.

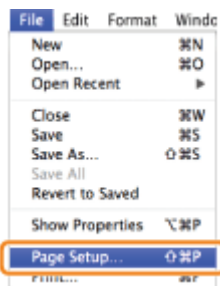

2.

Select **[Page Attributes]** from **[Settings]**.

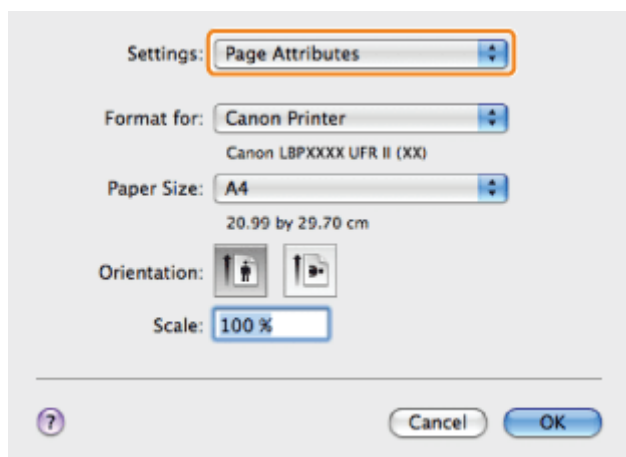

3.

Select your printer from **[Format for]** → set **[Paper Size]**, **[Orientation]**, and **[Scale]** as necessary.

4.

Select **[Save As Default]** from **[Settings]** → click **[OK]**.

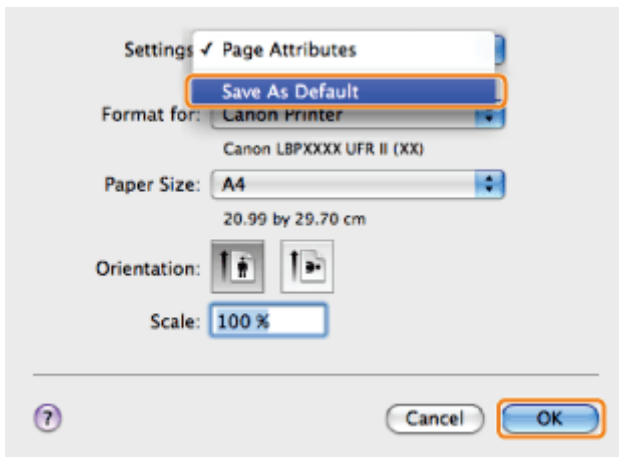

The settings are saved as the default settings.

NOTE

- In Mac OS X 10.5.x, the [Page Setup] dialog box differs according to the application.
- The screen may vary according to the operating system, as well as the type and version of the printer driver.

Setting the Printer Options

04L9-05K

When using the printer driver for the first time, or changing the printer settings, follow the procedure below to obtain the printer information and set the installable options.

- ❖ Mac OS X 10.4.x
- ❖ Mac OS X 10.5 and later

Mac OS X 10.4.x

1.

Open [System Preferences] → click [Print & Fax].



2.

Click [Printing] → select your printer → click [Printer Setup].

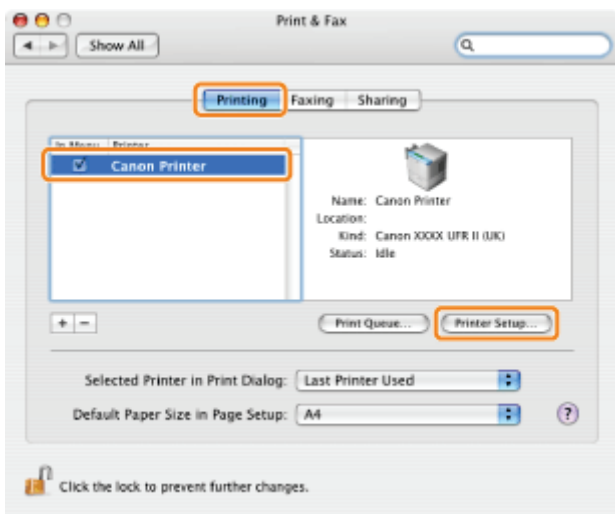

3.

Select [Installable Options] → configure the options attached to and installed in the printer → click [Apply Changes].

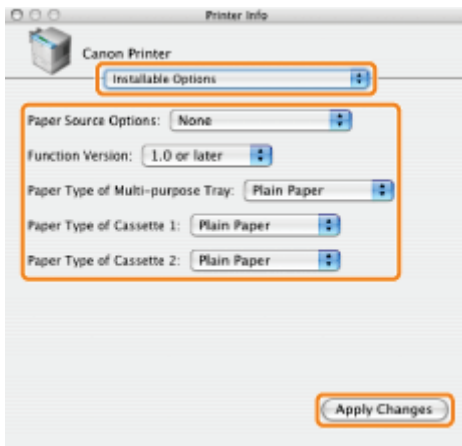

The options installed in the printer are ready to use.

IMPORTANT

- Be sure to select only those options that are actually installed in the printer.

NOTE

- If you close the [Printer Info] dialog box without clicking [Apply Changes], the setting you have made will not be saved.

Mac OS X 10.5 and later

1.

Open [System Preferences] → click [Print & Fax] or [Print & Scan].



2.

Select the printer you are using → click [Options & Supplies].

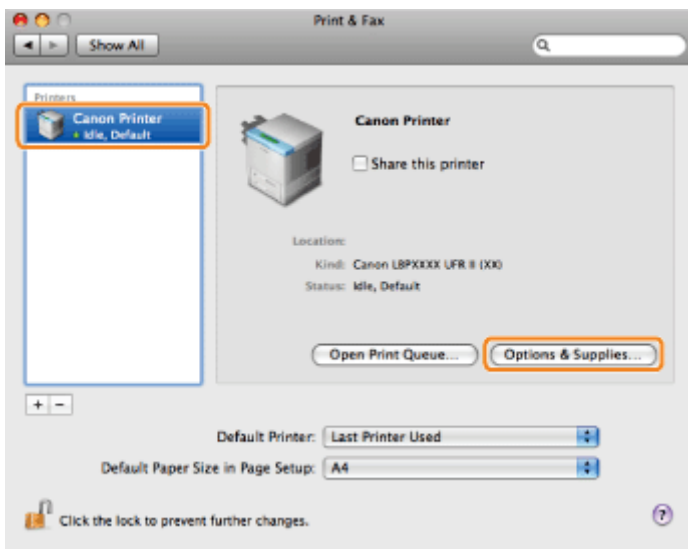

3.

Click **[Driver]** → confirm that your printer is selected for **[Print Using]** → configure the options attached to and installed in the printer.

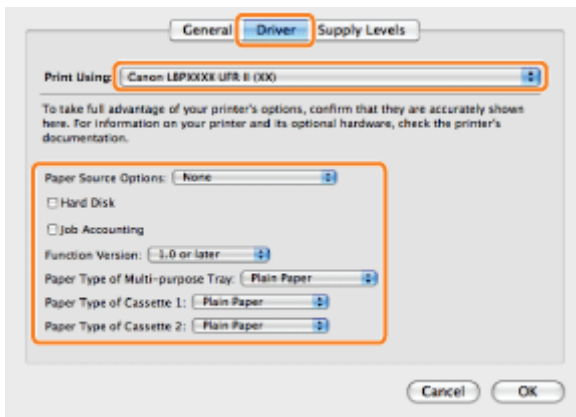

4.

Click **[OK]**.

IMPORTANT

- Be sure to select only those options that are actually set in the printer.

NOTE

- The screen may vary according to the operating system, as well as the type and version of the printer driver.
- Depending on the type and version of the printer driver, [Printer Info] may be displayed in the [Print] dialog box. If so, click [Printer Info] to obtain or verify printer information.

Viewing the Online Help

04L9-05L

You can display the online help by clicking [?] in the [Page Setup] dialog box or the [Print] dialog box.

The online help includes additional information about every printing option. If this manual does not provide the information you need, see the online help.

1.

Select your printer from [Printer] → select a preferences pane → click [?].

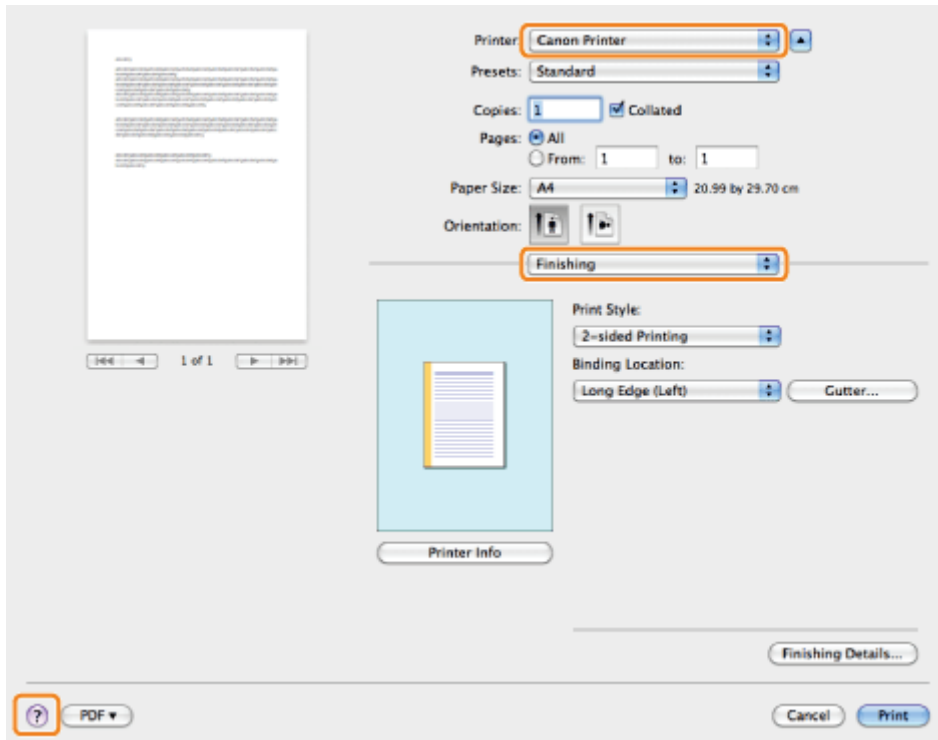

Select one of the following preferences panes:

- [Paper Source] preferences pane
- [Finishing] preferences pane
- [Quality] preferences pane
- [Special Features] preferences pane

The online help is displayed.

Canon UFR II Printer Driver Help

Top > Contents > Panels and Dialog boxes > [Finishing] preferences pane

[Finishing] preferences pane

This pane lets you specify paper output settings such as print style (1-sided Printing, 2-sided Printing, etc.), paper output method, and gutter width.

NOTE

- In Mac OS X version 10.5 and later, depending on the application, the settings in each preferences pane are displayed at the bottom.
- The functions that are available for the printer you are using depend on the printer model, function version, and installed options. To find out which functions are available for the printer you are using, refer to the instruction manual provided with the printer.

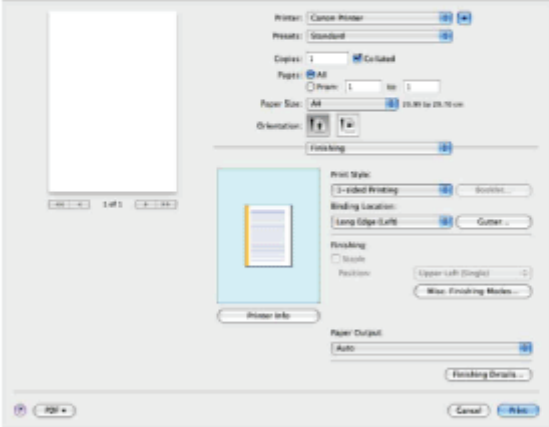

NOTE

- For details about the conditions supported by [Perfect Binding], such as paper sizes etc., refer to "[Supported Conditions for Perfect Binding.](#)"
- The default setting for [Print Style] for some printers that support two-sided printing is [2-sided Printing].
- You can save printer driver settings that you frequently use as a Preset. For details about how to save the settings, see "[Saving a Preset.](#)"

[Print Style]: Allows you to select a print style from 1-sided Printing, 2-sided Printing, Booklet Printing, or

NOTE

- For details about how to display the [Page Setup] dialog box and the [Print] dialog box, see "[Printing with the Printer Driver.](#)"
- The screen may vary according to the operating system, as well as the type and version of the printer driver.

Viewing the Driver Guide

04L9-05R

To view the driver guide, follow the procedure below.

1.

Open the [Documents] folder in the printer driver install set folder.

The location of the [Documents] folder may vary depending on the type and version of the printer driver.

2.

Double-click the "index.html" icon.

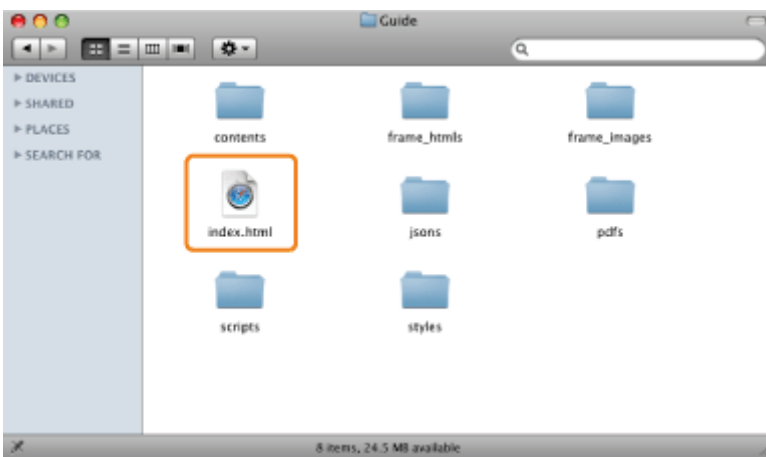

The driver guide is displayed.

NOTE

- The location of the [Documents] folder may vary depending on the type and version of the printer driver.
- Depending on the printer model you are using, the installation guide may be a PDF file. If so, double-click the PDF icon in the [Documents] folder.

Printing Functions

04L9-05S

This section explains printing functions which can be configured in the printer driver screen.

- ❖ Common Functions
- ❖ [Layout] Preferences Pane
- ❖ [Finishing] Preferences Pane
- ❖ [Paper Source] Preferences Pane
- ❖ [Quality] Preferences Pane
- ❖ [Special Features] Preferences Pane

 **NOTE**

- Available settings may differ according to the operating system, as well as the type and version of the printer driver.
- If you are using Mac OS X 10.5.x, click [] to display all of the settings in the [Print] dialog box.

Common Functions

04L9-05U

Selecting [Print] from the [File] menu of the application displays the [Print] dialog box.

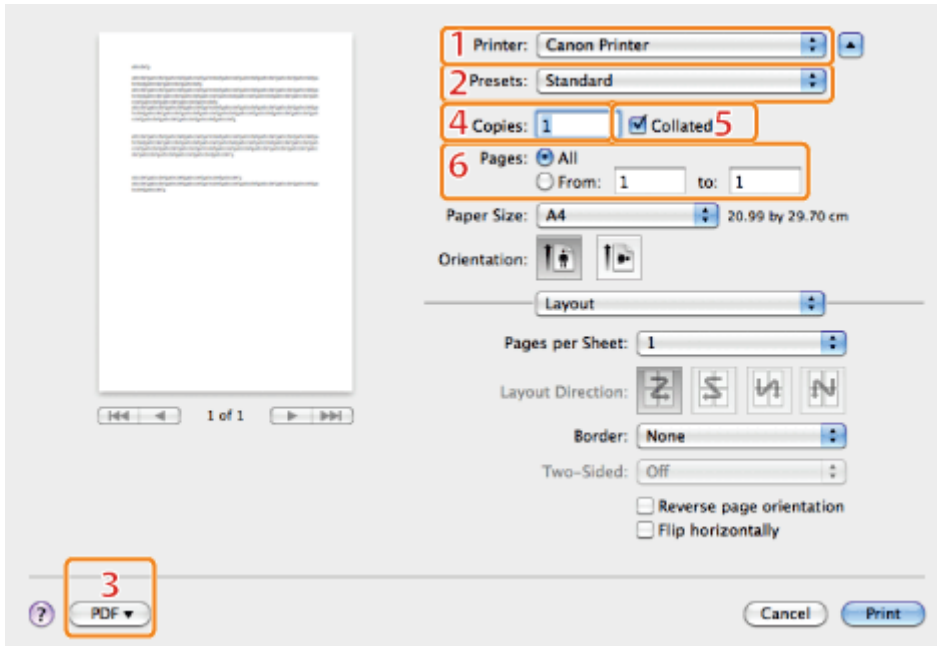

<p>1.Printer Selection</p>	<p>Selects the printer to use from those previously added to the [Printing] pane of the [Print & Fax] or [Print & Scan] dialog box in the [System Preferences].</p>	<p>2.Presets</p>	<p>Combinations of frequently used settings can be saved as presets. These saved presets can then be selected for printing (see "Using Presets for Printing").</p>
<p>3.Save As PDF</p>	<p>Saves the document as a PDF file.</p>	<p>4.Copies</p>	<p>Specifies the number of copies to print.</p>
<p>5.Collated</p> 	<p>If two or more copies are to be printed, enables them to be output in sets.</p>	<p>6.Pages</p>	<p>Specifies the range of pages to be printed.</p>

NOTE

- The displays may differ between operating systems, printer driver types, and functions.
- If you are using Mac OS X 10.4.x, you can set the above functions in the [Copies & Pages] dialog box.

[Layout] Preferences Pane

04L9-05W

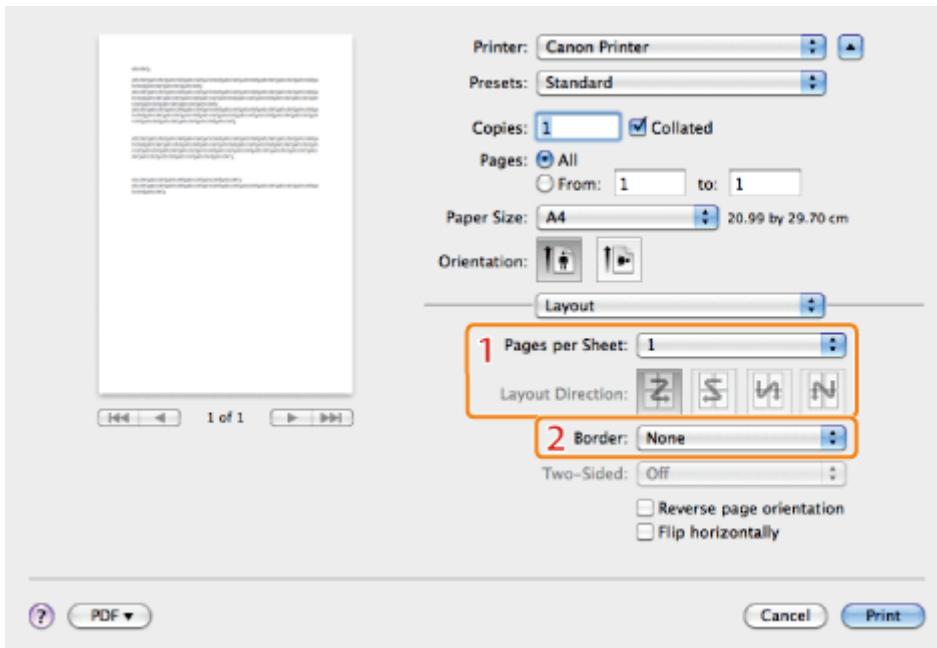

1. Page Layout



Prints multiple pages on one sheet of paper (see "[Printing Multiple Pages on One Sheet](#)").

2. Page Border

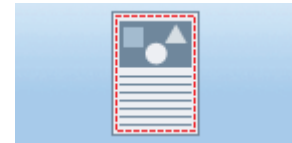

Prints each page with a border.

NOTE

The displays may differ between operating systems, printer driver types, and functions.

[Finishing] Preferences Pane

04L9-05X

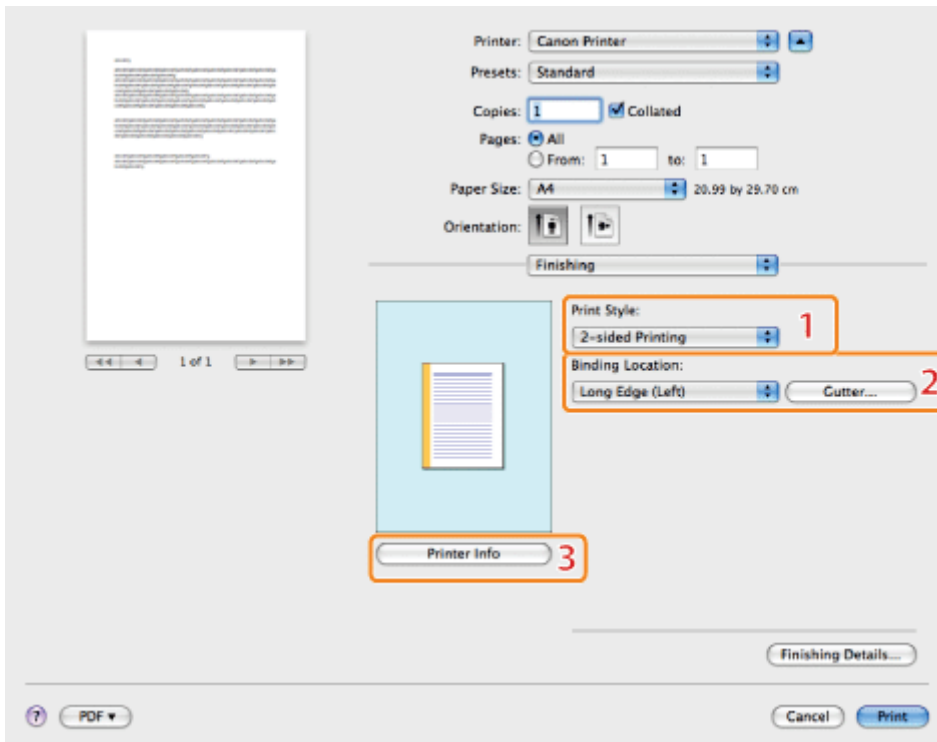

<p>1.1-sided/2-sided Printing</p> 	<p>Prints on one or both sides of the paper. The default setting for [Print Style] is [2-sided printing] (see "1-sided/2-sided Printing").</p>	<p>2.Binding Location/Gutter</p>	<p>Sets the orientation and width of the gutter.</p>
		<p>3.Printer Info</p>	<p>Obtains printer information (the name of the printer model, installed options, and paper source status).</p>

NOTE

The displays may differ between operating systems, printer driver types, and functions.

[Paper Source] Preferences Pane

04L9-05Y

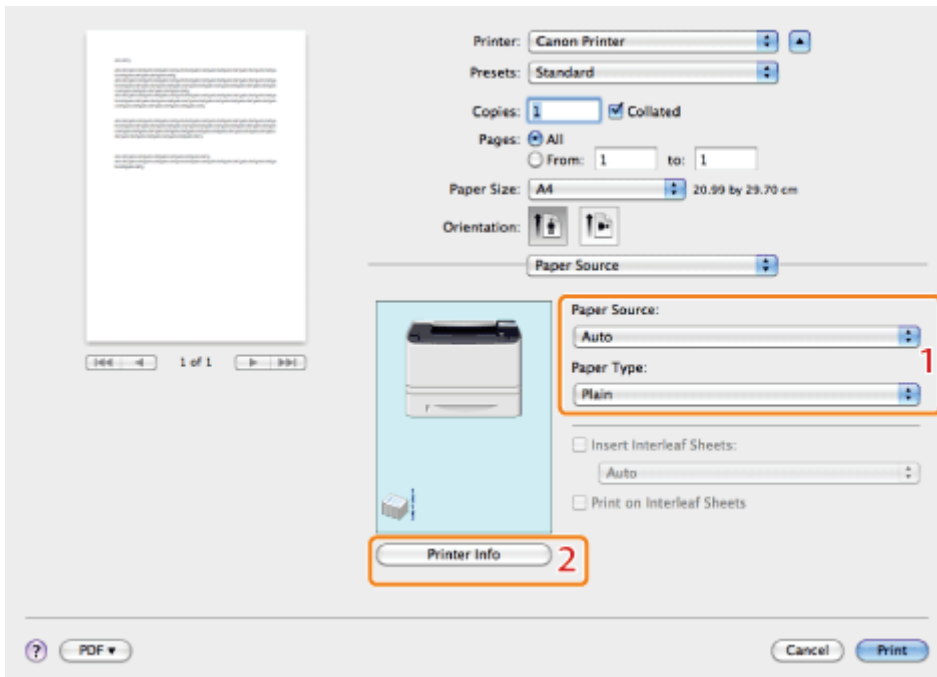

1.Paper Source



When you want to print on a specific type of paper, specify the paper source containing the paper, or the paper type.

2.Printer Info

Obtains printer information (the name of the printer model, installed options, and paper source status).

NOTE

The displays may differ between operating systems, printer driver types, and functions.

[Quality] Preferences Pane

04L9-060

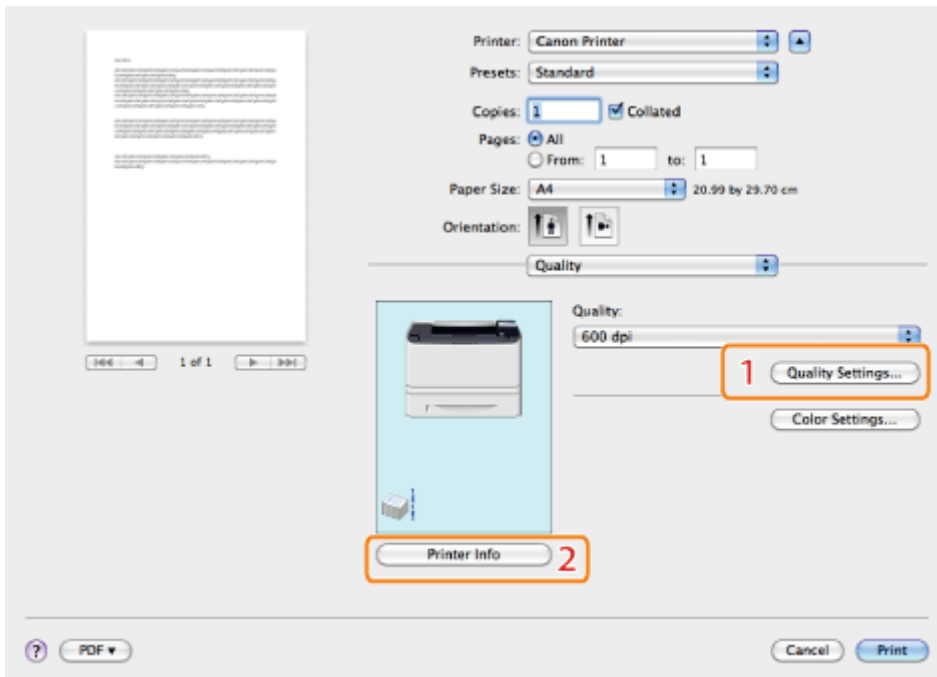

1. Quality Settings

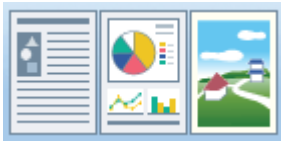

Enables you to configure settings relating to print quality.

2. Printer Info

Obtains printer information (the name of the printer model, installed options, and paper source status).

NOTE

The displays may differ between operating systems, printer driver types, and functions.

[Special Features] Preferences Pane

04L9-061

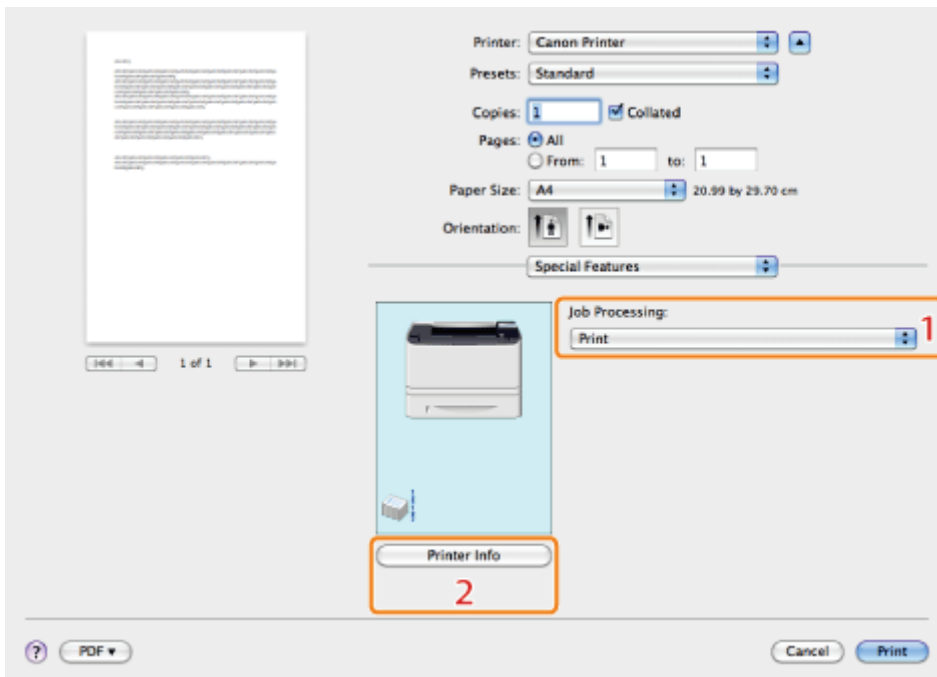

1. Job Processing

Enables you to change the output method so that print data is saved to a mail box in the printer memory etc.

2. Printer Info

Obtains printer information (the name of the printer model, installed options, and paper source status).

NOTE

The displays may differ between operating systems, printer driver types, and functions.

Scaling Documents

04L9-062

You can enlarge or reduce the size of the document to be printed.

There are two methods for scaling a document: select the paper size to be printed to scale it automatically, or specify the scaling value manually.

1.

Select [Page Attributes] from [Settings] in the [Page Setup] dialog box.

For details on how to display the [Page Setup] dialog box, see "[Configuring the Page Settings Beforehand.](#)"

2.

Select your printer → select a paper size for printing from [Paper Size].

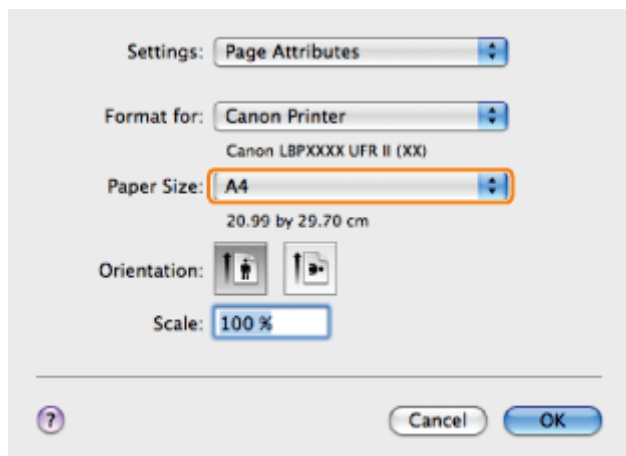

Where the paper size specified in the application and that specified in this preferences pane differ, scaling is set automatically.

If you want to increase or decrease the magnification manually, specify the zoom ratio for [Scale].

3.

Click [OK].

4.

Select [Print] from the [File] menu.

5.

Select your printer → specify the desired settings →click [Print].

NOTE

- Depending on the printer model you are using, you may not be able to magnify the document to the optimum ratio for the selected page size.
-

In Mac OS X 10.5.x, the [Page Setup] dialog box may not be displayed, depending on the application you are using. If this is the case, you can specify the page size, page orientation, and scaling in the [Print] dialog box. For details about how to display the [Print] dialog box, see "[Printing with the Printer Driver.](#)"

- The screen may vary according to the operating system, as well as the type and version of the printer driver.
-

Printing Multiple Pages on One Sheet

04L9-063

A multiple pages can be printed on one sheet of paper.

1.

Select **[Print]** from the **[File]** menu of the application.

2.

Select your printer from **[Printer]** → **[Layout]** → the number of pages you want to print onto one sheet of paper from **[Pages per Sheet]**.

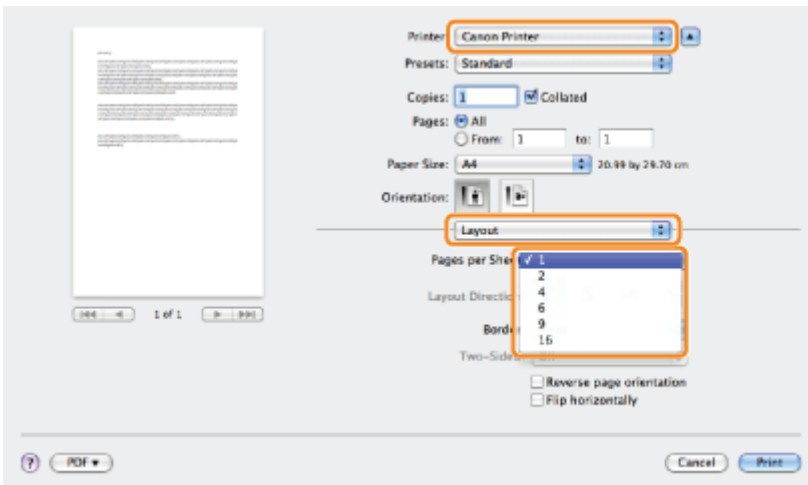

3.

Select the page order from **[Layout Direction]**.

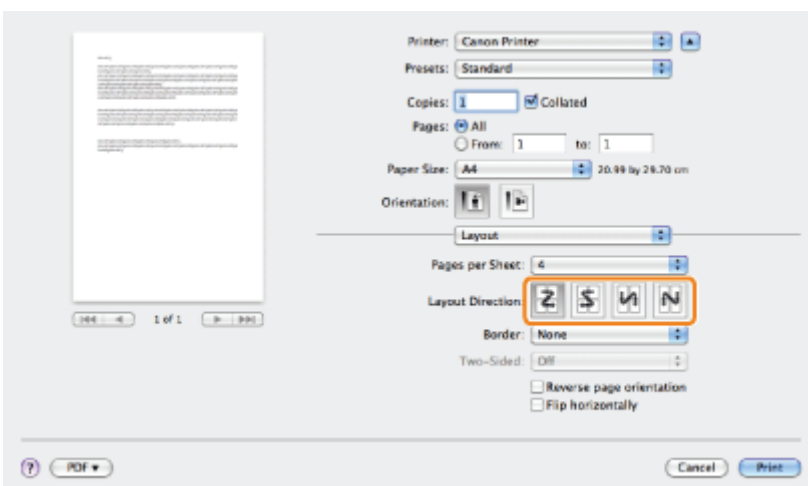

4.

If you want to add a border to each page, select the line type from **[Border]**.

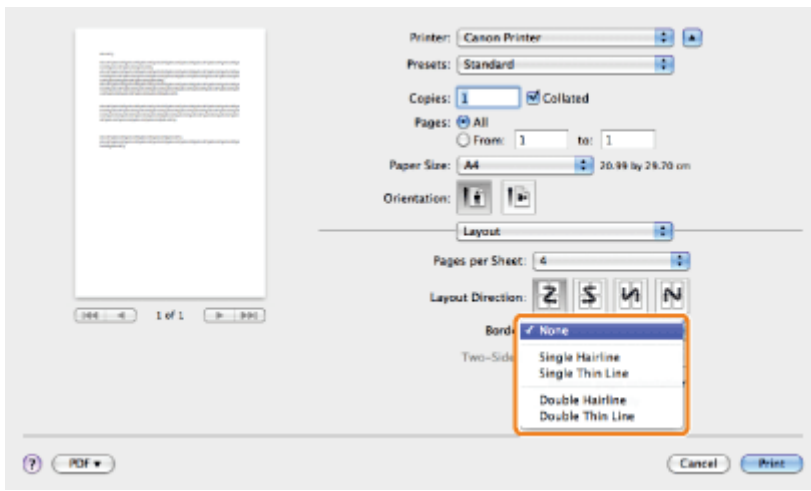

5.

Click **[Print]**.

NOTE

- You cannot enlarge and reduce manually when using this function.
- The screen may vary according to the operating system, as well as the type and version of the printer driver.

1-sided/2-sided Printing

04L9-064

You can select whether to print on one side or both sides of each sheet of paper.

Paper Type	Paper Size
Plain paper (60 to 90 g/m ²) Heavy paper (91 to 120 g/m ²)	<ul style="list-style-type: none">A4, Legal, Letter

Before performing 2-sided printing, see "Attention (1-sided Printing and 2-sided Printing)."

IMPORTANT

Precautions when performing 2-sided printing

- Do not touch the paper during 2-sided printing until it is completely output. The paper is first partially output after the front side is printed, and then it is fed again to be printed on the back side.
 - Be sure to close the output selection cover before performing 2-sided printing.
- ["Paper Loading and Output"](#)

Printing on the back side of paper whose front side is already printed

This printer enables you to perform 2-sided printing by manually inserting the back side of the paper* whose front side was previously printed even if the paper cannot be used for 2-sided printing.

When printing on the back side of paper whose front side was previously printed, flatten out any curled paper and load one sheet of paper at a time in the multi-purpose tray.

* This is only for paper that has been printed using this printer. Also, you cannot print again on the same side of the paper that was printed before.

* If you are using A5 paper, the back side may not be printed correctly.

1.

Select **[Print]** from the **[File]** menu of the application.

2.

Select your printer from **[Printer]** → **[Finishing]** → Select **[1-sided Printing]** or **[2-sided Printing]** from **[Print Style]**.

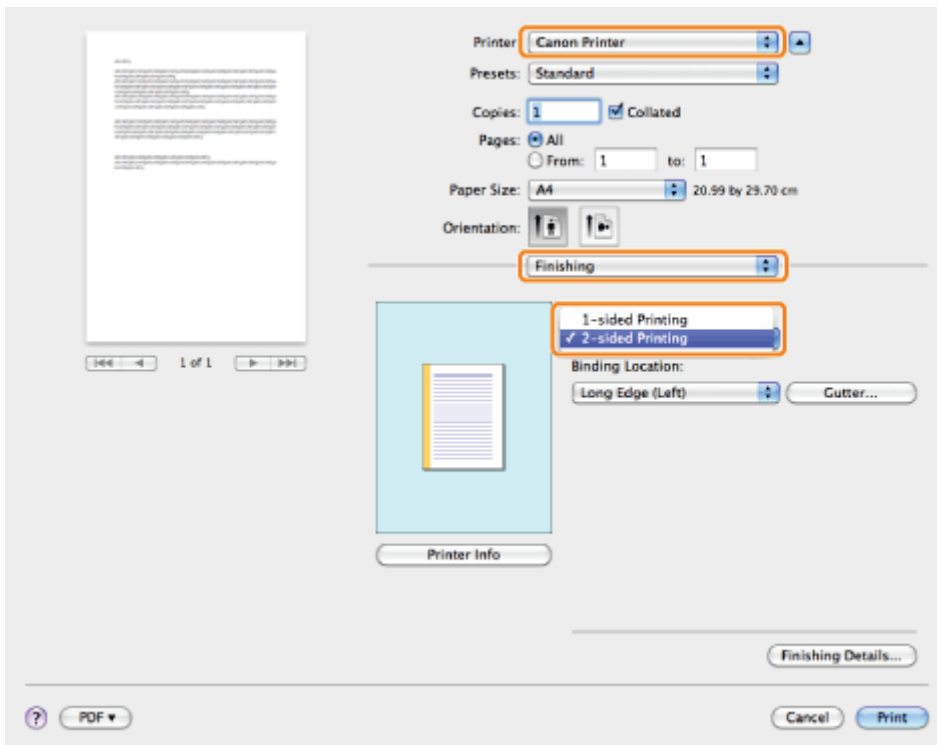

NOTE

The default setting for [Print Style] is [2-sided Printing].

3.

Select the binding edge from [Binding Location].

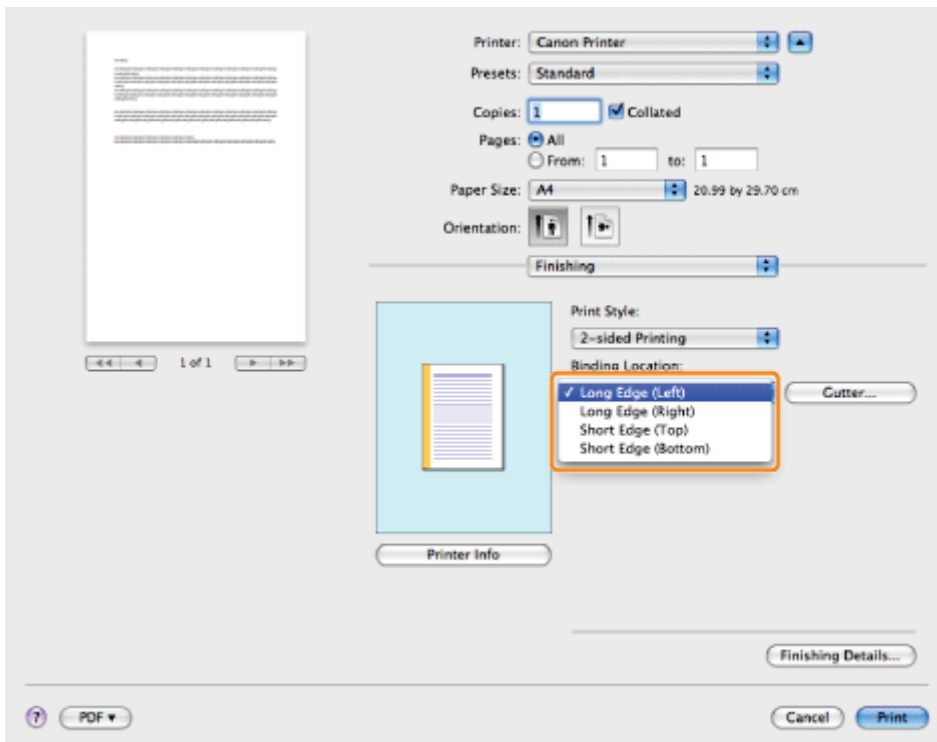

The output image is displayed in the preview area.

4.

If you want to set the gutter width, click [Gutter].

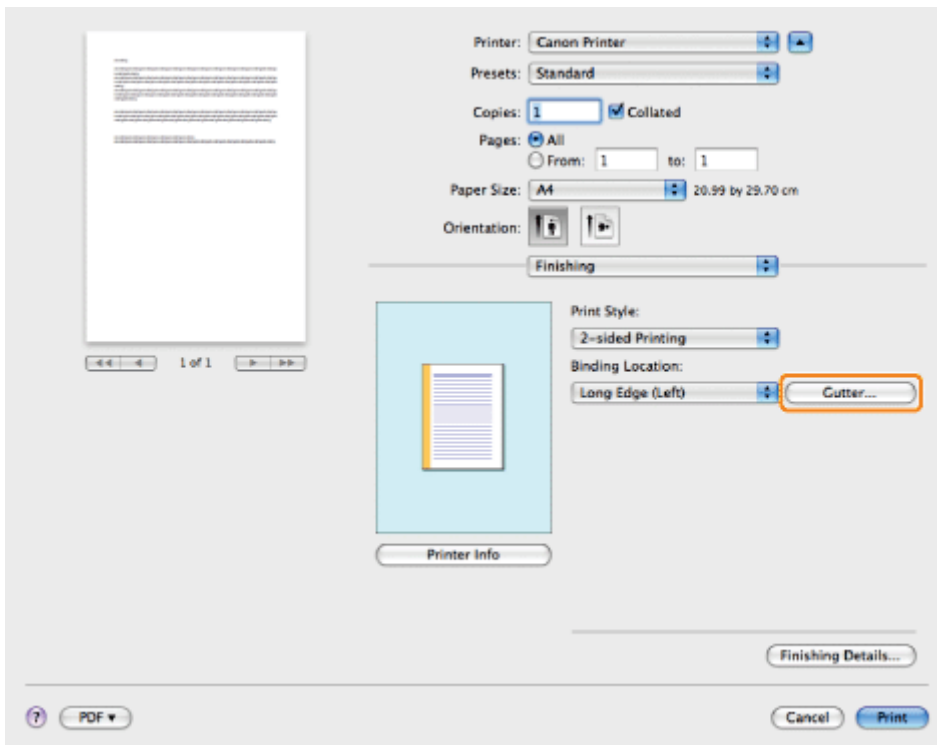

If you do not set the gutter width, skip to step 6.

5.

Specify the gutter width → click [OK].

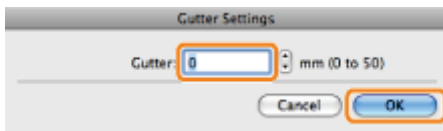

6.

Click [Print].

NOTE

The screen may vary according to the operating system, as well as the type and version of the printer driver.

Using [Presets] for Printing

04L9-066

You can save print settings that you specified in each preferences pane of the [Print] dialog box use as a preset. A preset is a combination of settings that you use frequently, saved as a single setting. If you select a preset when printing a file, the file will be printed with the saved settings.

1.

Select [Print] from the [File] menu of the application.

2.

Select your printer from [Printer] → in each preferences pane of the [Print] dialog box, specify the print settings you want to save as a preset.

Note

For information on available printing functions, see "[Printing Functions](#)" or the online help. (See "[Viewing the Online Help](#).")

3.

Select [Save As] from [Presets].

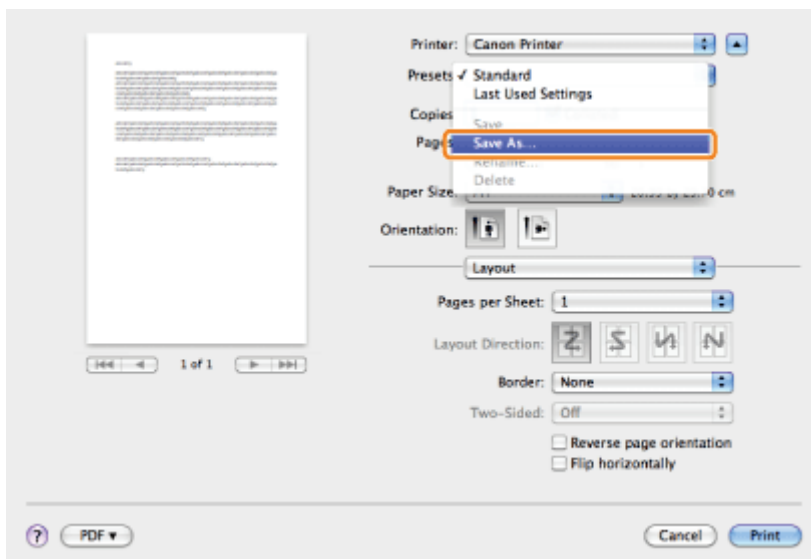

4.

Enter a name in [Save Preset As] → click [OK].

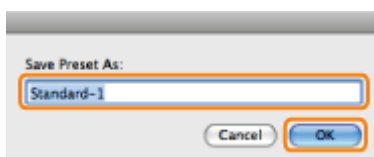

The saved preset will be displayed in [Presets] in the [Print] dialog box.

5.

To print a file using a preset, select the preset from [Presets] in the [Print] dialog box → click [Print].

NOTE

- To edit a preset, in the [Print] dialog box, select the preset → specify the printer driver settings → select [Save] from [Presets].
- To change a preset's name, select the preset → select [Rename] from [Presets].
- To delete a preset, select the preset → select [Delete] from [Presets].

Setting Priority (When Specifying the Same Item Using Multiple Methods)

04L9-067

When the setting values for the same item are different between an application or the printer driver and the menu functions, the setting specified in the application or printer driver is effective. When specifying an item only in the menu functions using the control panel or the Remote UI, the most recently specified setting is effective.

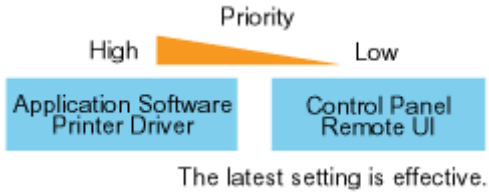

Setting priority of direct print

The direct print function gives priority to the contents specified using the [Direct Print] menu in the Remote UI or tags in IFD (Image file directory) that the header of TIFF data of image file has over those specified using the control panel or the [Preferences] menu in the Remote UI.

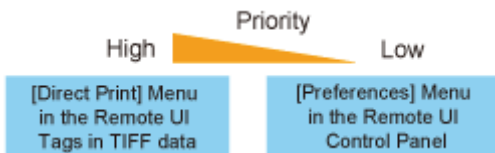

Some of the tag function that the header of TIFF data has may not become valid.

Functions Which Can Be Specified from the Control Panel

04L9-068

This printer allows you to specify the printing functions from the printer driver. However, some printing functions are specified from the control panel or the Remote UI. The following table shows the functions to be specified from the control panel or the Remote UI.

For details on the items you can manage using the control panel, see "[Setting Items](#)."

Function	Overview of the Function
Multi-purpose tray paper size	Specifies the size of the paper loaded in the multi-purpose tray. <ul style="list-style-type: none"> ❖ "[Setup] Menu ([Paper Source] Options)" ❖ "[Select Feeder] Menu"
Multi-purpose tray priority	Specifies whether the printer should detect the paper source in order starting with the multi-purpose tray. <ul style="list-style-type: none"> ❖ "[Setup] Menu ([Paper Source] Options)"
Drawer N (N = 1, 2) size	Specifies the size of the paper loaded in the paper drawer (Drawer 1 or 2). <ul style="list-style-type: none"> ❖ "[Setup] Menu ([Paper Source] Options)" ❖ "[Select Feeder] Menu"
Standard paper size	Since paper size cannot be specified when printing from DOS, UNIX or other operating system, specify it using this setting. <ul style="list-style-type: none"> ❖ "[Setup] Menu ([Paper Source] Options)"
Invalid paper tray	Specifies what the printer does when paper that is the same size as the paper size of the received data is not loaded in the selected paper source. <ul style="list-style-type: none"> ❖ "[Setup] Menu ([Paper Source] Options)"
Auto selection	Specifies the paper source to be automatically selected. <ul style="list-style-type: none"> ❖ "[Setup] Menu ([Paper Source] Options)"
Standard paper type	Since paper type cannot be specified when printing from DOS, UNIX or other operating system, specify it using this setting. <ul style="list-style-type: none"> ❖ "[Setup] Menu ([Paper Source] Options)"
Adjust Print Position	Adjusts the printing position in the vertical direction (Y) or the horizontal direction (X). <ul style="list-style-type: none"> ❖ "[Setup] Menu ([Layout] Options)" ❖ "[Setup] Menu ([User Maintenance] Options)"
Alternative method	If the last page for the 2-sided printing is 1-sided printing, 1-sided printing is applied to the last page. <ul style="list-style-type: none"> ❖ "[Setup] Menu ([Layout] Options)"
Image Refinement	Set whether to use the smoothing process to print the jagged edges of text and graphics. <ul style="list-style-type: none"> ❖ "[Setup] Menu ([Quality] Options)"
Recovery printing	Specifies whether to print the partially printed page when the printer stops printing due to a paper jam or an error occurring. <ul style="list-style-type: none"> ❖ "[Setup] Menu ([User Maintenance] Options)"
Check paper size	Specifies whether the printer should stop printing, displaying the message <Check paper size.> or continue printing. <ul style="list-style-type: none"> ❖ "[Setup] Menu ([User Maintenance] Options)"
Substitute size	The printer switches the paper size if the paper of the size to be used is not loaded in the printer. <ul style="list-style-type: none"> ❖ "[Setup] Menu ([User Maintenance] Options)"
Plain paper curl adjustment	If printed plain paper curls, specify the setting for this item. <ul style="list-style-type: none"> ❖ "[Setup] Menu ([User Maintenance] Options)"

Printing without the Printer Driver (Direct Print)

04L9-069

The direct print function is a function that transmits a file from the host terminal to the printer without the printer driver and allows the printer to detect the file and print. Therefore, you do not need to open a file to print.

Direct Print from the Remote UI

You can specify PDF, TIFF, JPEG, PS, EPS, or XPS format image files from the remote UI and perform Direct Print. For details on operating the Remote UI, see "Remote UI."

- [Printing the PDF File Using the Direct Print Function](#)

- [Printing the PS/EPS File Using the Direct Print Function](#)

- [Printing the TIFF/JPEG File Using the Direct Print Function](#)

- [Printing the XPS File Using the Direct Print Function \(LBP6680x Only\)](#)

<Direct Print using Command Prompt>

You can Direct Print using the LPR command line.

- ["Direct Printing from Command Prompt"](#)

IMPORTANT

When printing PDF files using the direct print function

- The PDF version that is supported is version 1.7.
- Decoding of encrypted PDF files is supported. The following encryption algorithms can be handled.
 - RC4 128bit
 - AES 128bit
 - AES 256bit

When printing image files using the direct print function

Note the following when printing image files using the direct print function.

- JPEG data is in compliance with the specifications of ITU-T recommendation T.81. TIFF data is in compliance with the specifications of Adobe TIFF Revision 6.0.
- The supporting status of encoding methods for JPEG data is as follows.
 - Supported encoding method
DCT baseline
 - Unsupported encoding methods
DCT extension
Reversible compression
Hierarchical
- The supporting status of encoding methods for TIFF data is as follows.
 - Supported encoding methods
Uncompressed
ITU-T recommendation T.4 One-dimensional coding
ITU-T recommendation T.4 Two-dimensional coding

ITU-T recommendation T.6 Basic facsimile coding
ITU-T recommendation T.81 JPEG (Basic DCT only)
PackBits (Apple Macintosh PackBits)
LZW

- Unsupported encoding methods
 - ITU-T recommendation T.82 JBIG
 - ITU-T recommendation T.43 JBIG
 - ITU-T recommendation T.44 MRC

† Printing may not be performed properly depending on the data.

 **NOTE**

If you cannot print a file using the direct print function or if the printing position is skewed

The file may be printed properly by opening it from an application and using the printer driver.

Printing the PDF File Using the Direct Print Function

04L9-06A

IMPORTANT

When Using LBP6670dn

In order to print PDF files directly, it is necessary to install the optional PS ROM.

1

Start the Remote UI.

➤ "Starting the Remote UI"

2

Select [PDF File] from the [Direct Print] menu.

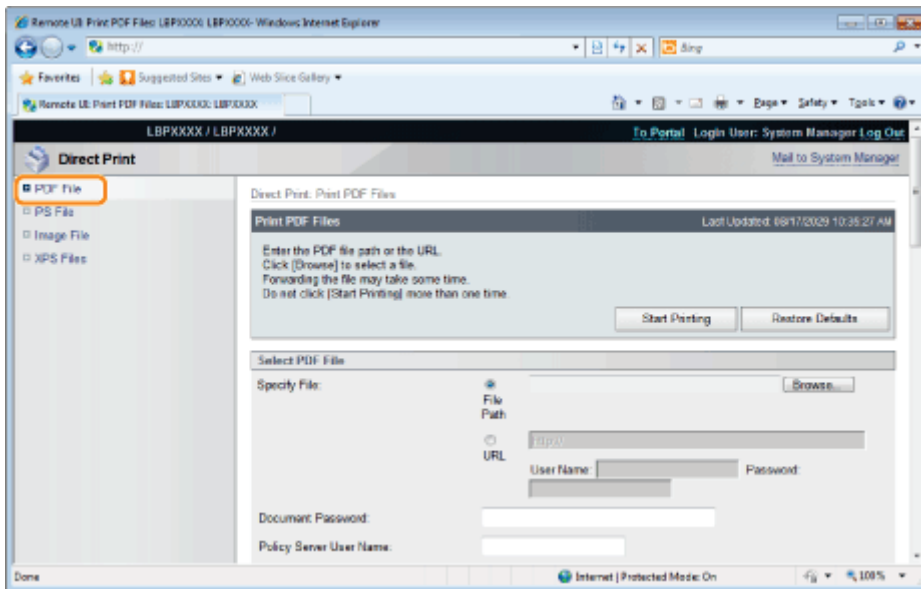

3

Specify [Select PDF File].

When specifying [File Path]

Click [Browse...], select the file, and then click [Open...].

When specifying [URL]

Enter the URL of the PDF file that you want to print.

- † If you specify a URL that requires user authentication, enter [User Name] and [Password].
- † When specifying a URL and printing, the next print job cannot be performed until the PDF is finished downloading or the connection with the Web server is terminated.
- † The protocol for specifying a URL and printing only supports HTTP.

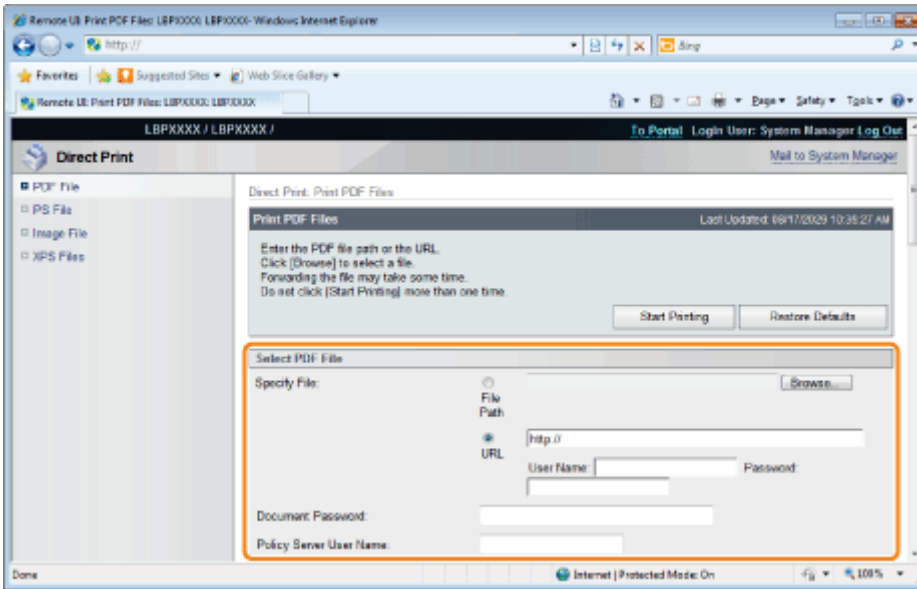

4

Enter the password in [Document Password] when a password is specified for opening the document or when it is necessary to enter a password to print.

- † If printing is attempted without entering a password, <Cannot decode PDF data.> is displayed, and printing is cancelled. When printing PDF files with settings that do not allow them to be printed or when printing in high resolution PDF files with settings that only allow them to be printed in low resolution, enter the master password.
- † When you print a PDF file linked to a policy server, enter [Policy Server User Name] and [Policy Server Password].

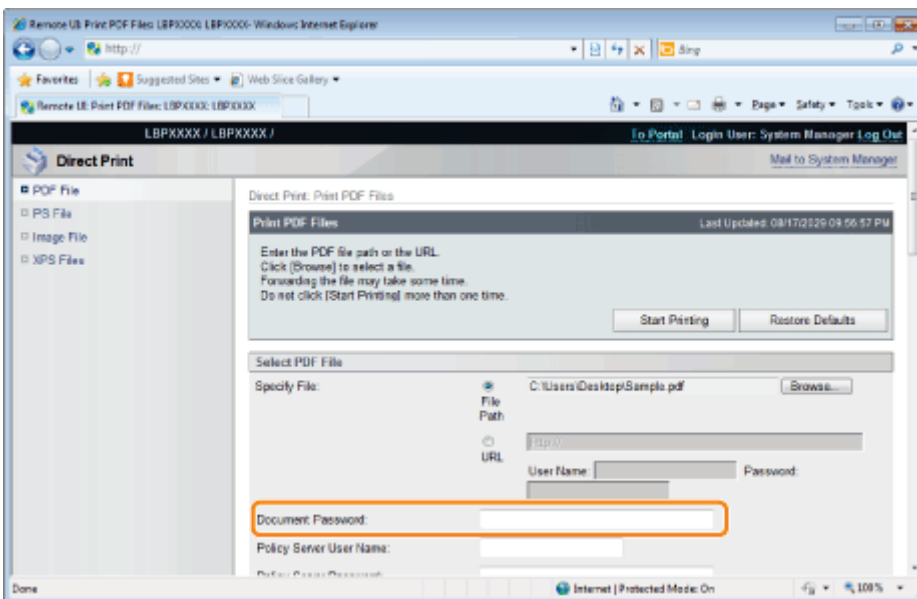

5

Specify the setting for [Specify Print Range].

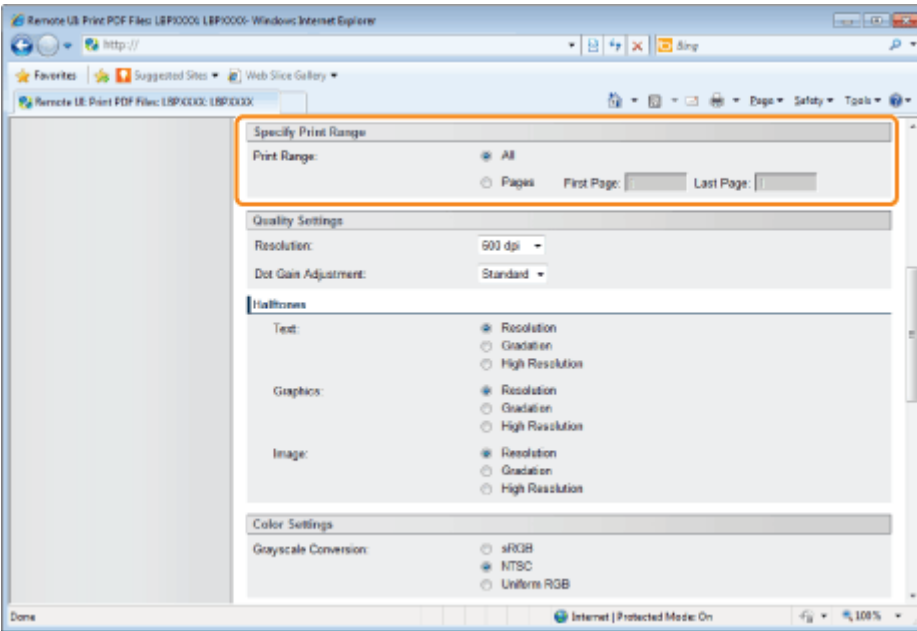

[All]	Select if you want to print all the pages.
[Pages]	Select [Pages], and then enter the starting page number and ending page number if you want to specify the print range.

6 Specify the settings for [Quality Settings] as the following, as needed.

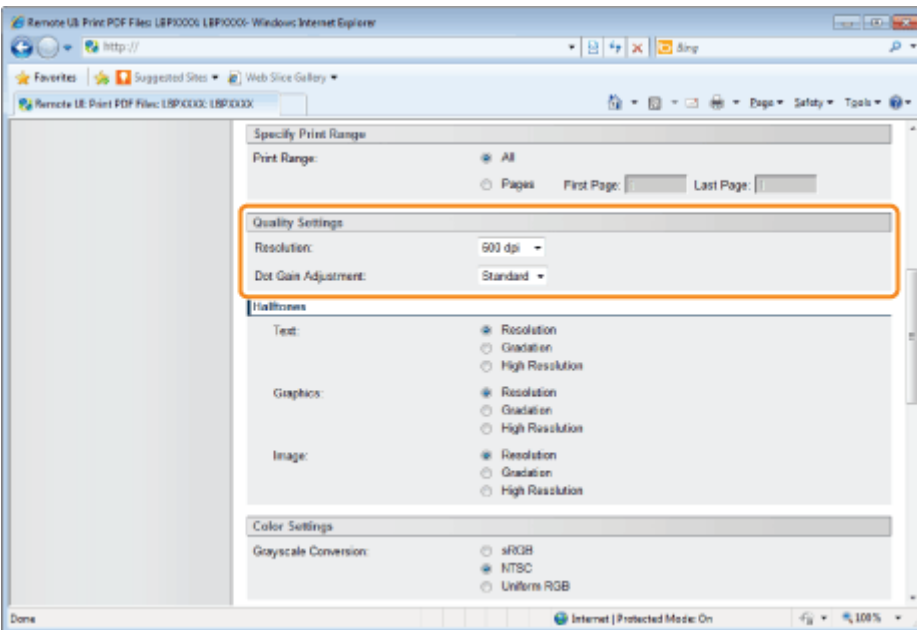

[Resolution]	Specify the resolution for printing the data. It is effective to set [600 dpi] when printing photographs at standard quality, and to set [1200 dpi] when printing at a higher quality.
[Dot Gain Adjustment]	You can adjust dotted areas to change darkness and lightness of painted areas. A higher number specifies a darker printed area.

7 Specify the settings for [Halftones] as the following, as needed.

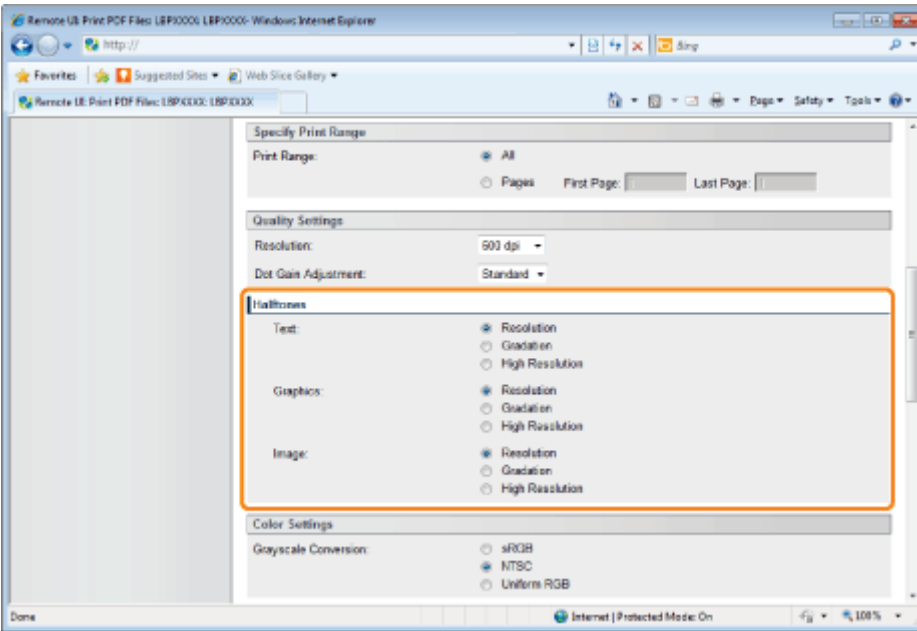

<p>[Halftones]</p>	<p>Specify the halftone display method when printing. You can set it for these data types: [Text], [Graphics] or [Image].</p> <p>[Resolution]: You can perform printing that combines smooth gradation with edge quality. It is suitable for printing graphics or graphs that use gradation.</p> <p>[Gradation]: You can print with a sharp gradation and well-balanced texture, contrasting light and shade, which is best suited for printing photo images.</p> <p>[High Resolution]: You can print in fine detail so that the edges of text data can be seen clearly. It is suitable for printing data containing text and fine lines.</p>
--------------------	---

8

Specify the settings for [Color Settings] as the following, as needed.

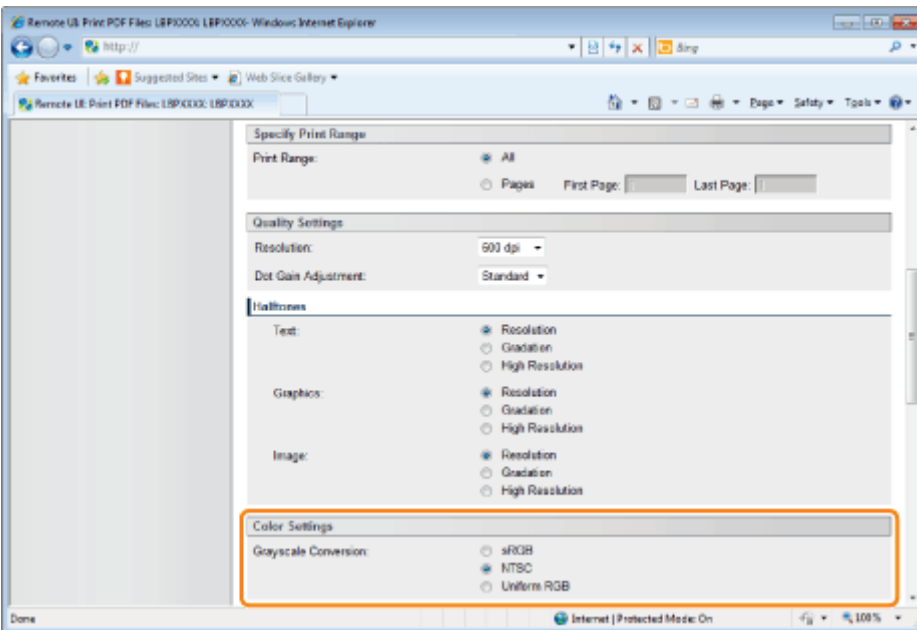

<p>[Grayscale]</p>	<p>Select the method for converting color print data to grayscale for printing.</p> <ul style="list-style-type: none"> This setting is for converting color data to B&W data. <p>[sRGB]: It calculates the grayscale value using the sRGB standard color conversion method.</p>
--------------------	--

Conversion]	[NTSC]:	It calculates the grayscale value using the NTSC standard color conversion method.
	[Uniform RGB]:	It takes the average value of the Red, Green and Blue color values as the grayscale value.

9

Specify the settings for [Print Settings] as the following, as needed.

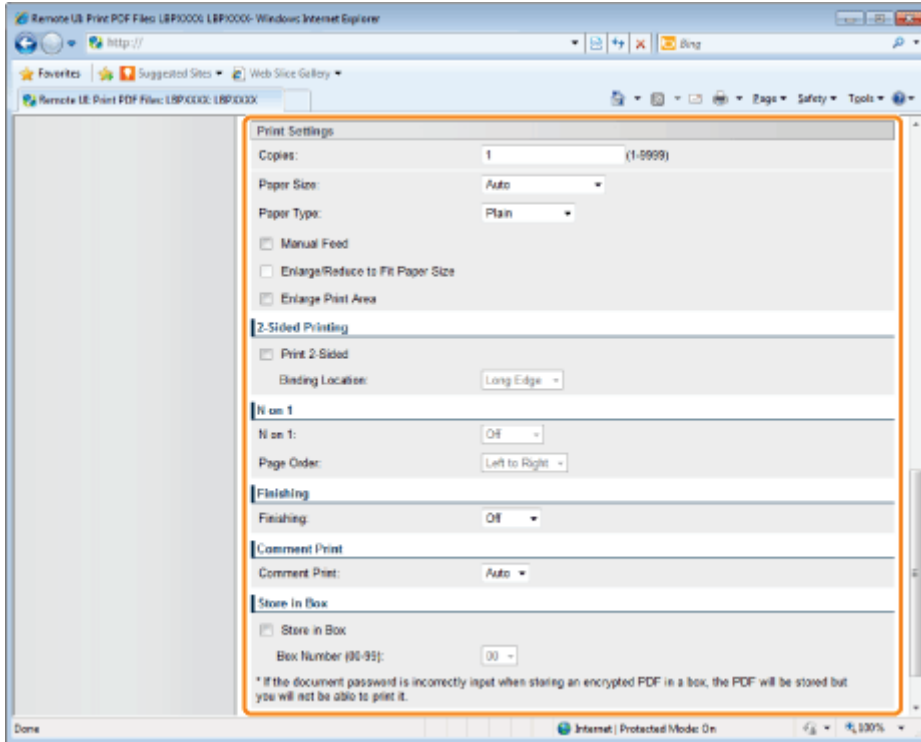

[Copies]	Specify the number of copies to be printed.
[Paper Size]	Specify the size of paper to print. If data is input that is outside the engine's maximum and minimum paper size range when the paper size is automatic, it is printed on the paper size that is set with [Standard Paper Size]. [Auto]: It selects the most suitable paper source for the PDF file page size, and prints. Other than [Auto]: It prints so that the long side of the page size of the PDF file and the long side of the selected paper size go in the same direction.
[Paper Type]	Specify the type of paper to print.
[Manual Feed]	You can fix the paper source in the multi-purpose tray.
[Enlarge/Reduce to Fit Paper Size]	If the check box is selected, it fixes the aspect ratio and scales it to fit with the effective print area of the paper size that is set and prints. However if [Paper Size] is set as [Auto], this item cannot be set.
[Enlarge Print Area]	Specify whether to expand the printable area and print. <ul style="list-style-type: none"> Depending on the document to be printed, part of the edges of the paper may not be printed.
[Print 2-Sided]	Specify 1-sided or 2-sided printing.
[Binding Location]	Set the binding position on the long side of the paper (long-edged binding) or the short side of the paper (short-edged binding). If binding is set from the printer side, the position of the "gutter" is automatically adjusted on the front and back sides of the paper.

[N on 1]	You can print multiple pages of the PDF file data arranged on one page. <ul style="list-style-type: none"> When printing multiple pages side by side, set [Paper Size] to a setting other than [Auto].
[Page Order]	The [N on 1] setting enables you to set the order the pages will be arranged on the paper when printing multiple pages on one page.
[Finishing]	(It is only displayed when an SD card is used.) It collates and prints in page or section units. [Off]: Print the number of copies specified for every page. [Collate]: The specified number of copies are collated.
[Comment Print]	Specify whether to print the notes of PDF files. [Off]: The notes are not printed. [Auto]: It only prints the notes that are specified within the PDF file as printable.
[Store in Box]	(It is only displayed when an SD card is used.) When storing it in a box, check the [Store in Box] check box before selecting the box where you want to store it.

10

Click [Start Printing].

† Do not keep clicking [Start Printing] while the file is transferring. Sometimes it takes time to transfer a file, but if you keep clicking during the transfer, a file failure may occur and it may be impossible to transfer it.

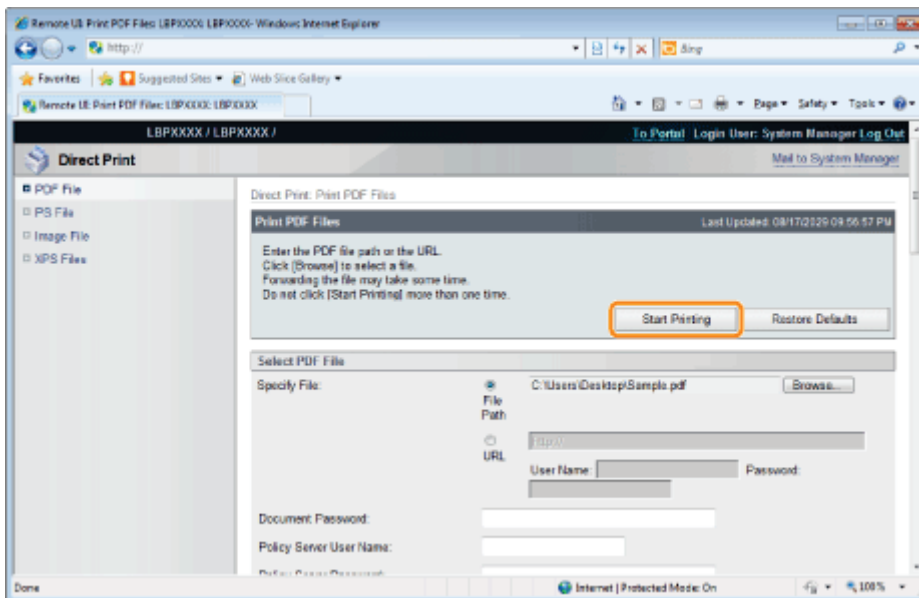

→ When the print job has finished sending, the display switches and the following message is displayed.

Press [To Job List] to check the print job that was sent.

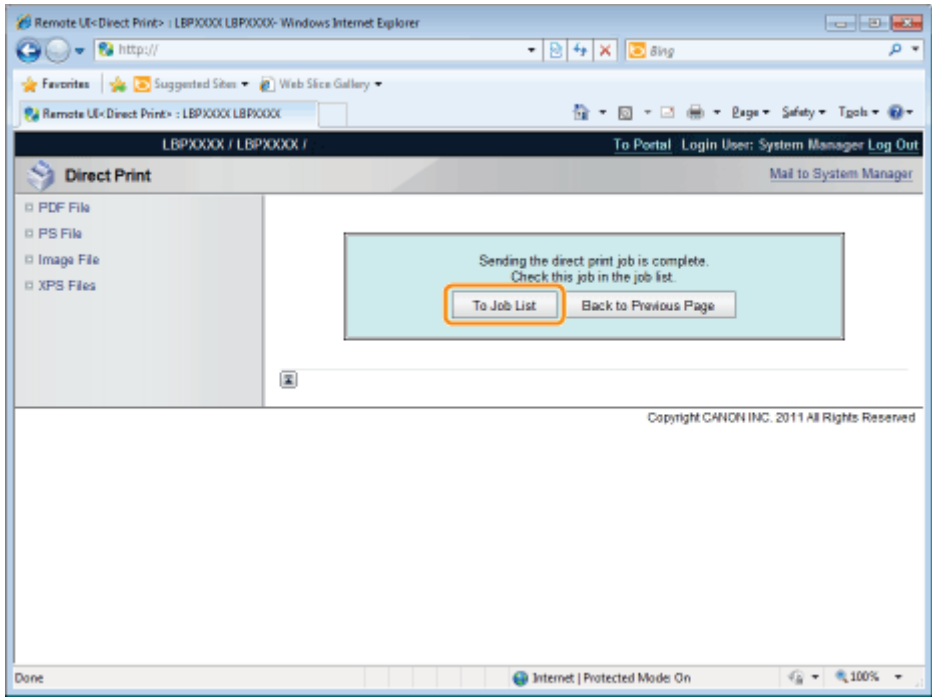

Printing the PS/EPS File Using the Direct Print Function

04L9-06C

IMPORTANT

When Using LBP6670dn

In order to print PS/EPS files directly, it is necessary to install the optional PS ROM.

1

Start the Remote UI.

➤ "Starting the Remote UI"

2

Select [PS File] from the [Direct Print] menu.

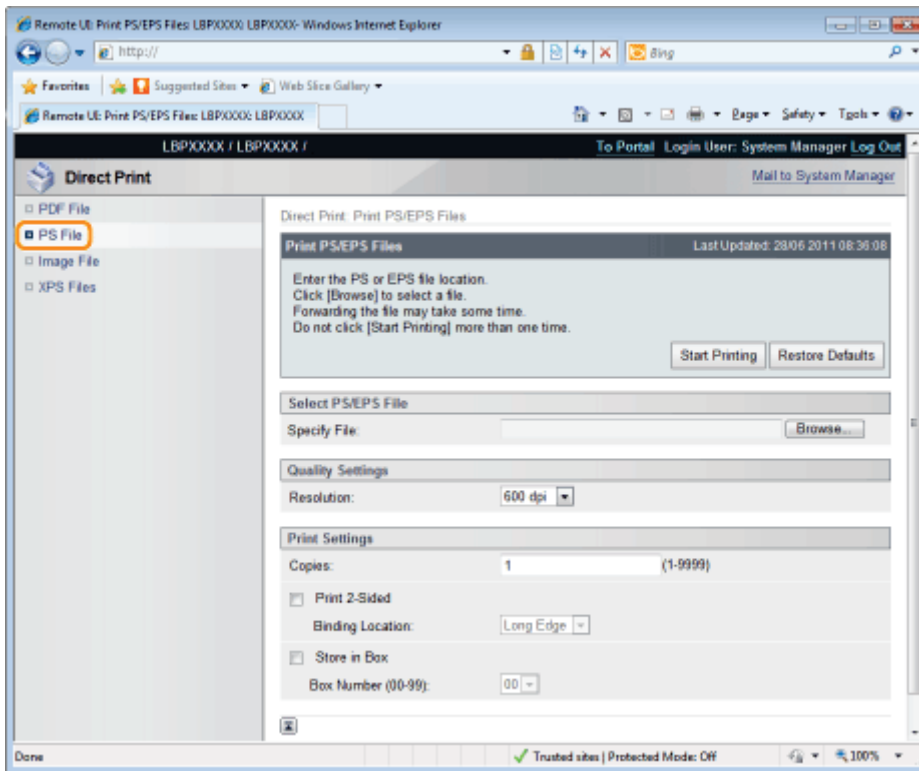

3

Specify [Select PS/EPS File].

Click [Browse...], select the file, and then click [Open...].

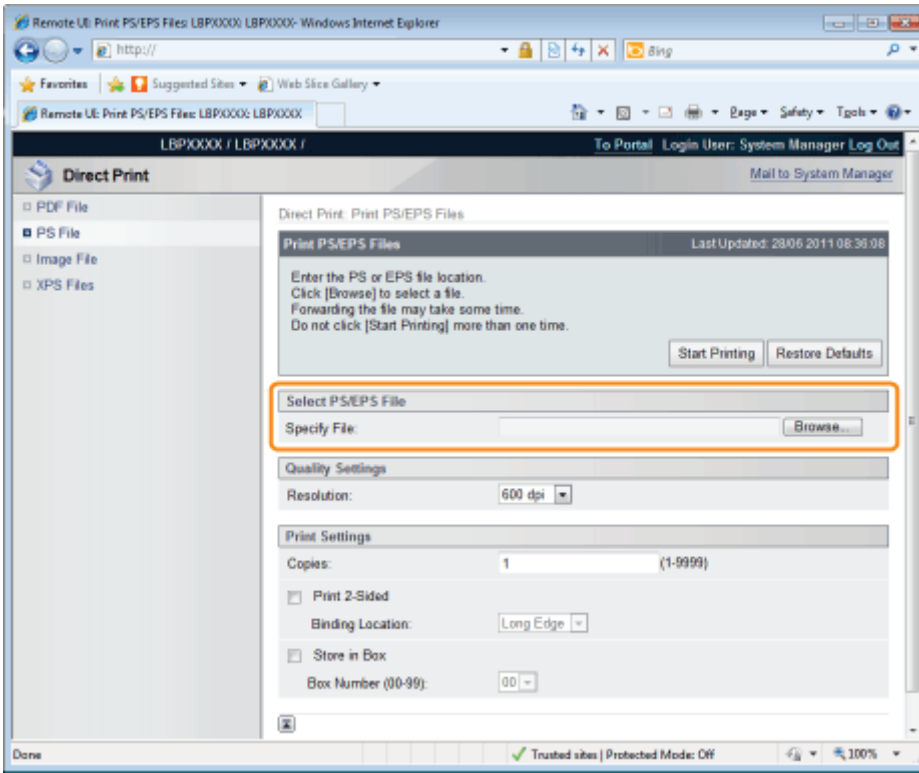

4 Specify the settings for [Quality Settings] as the following, as needed.

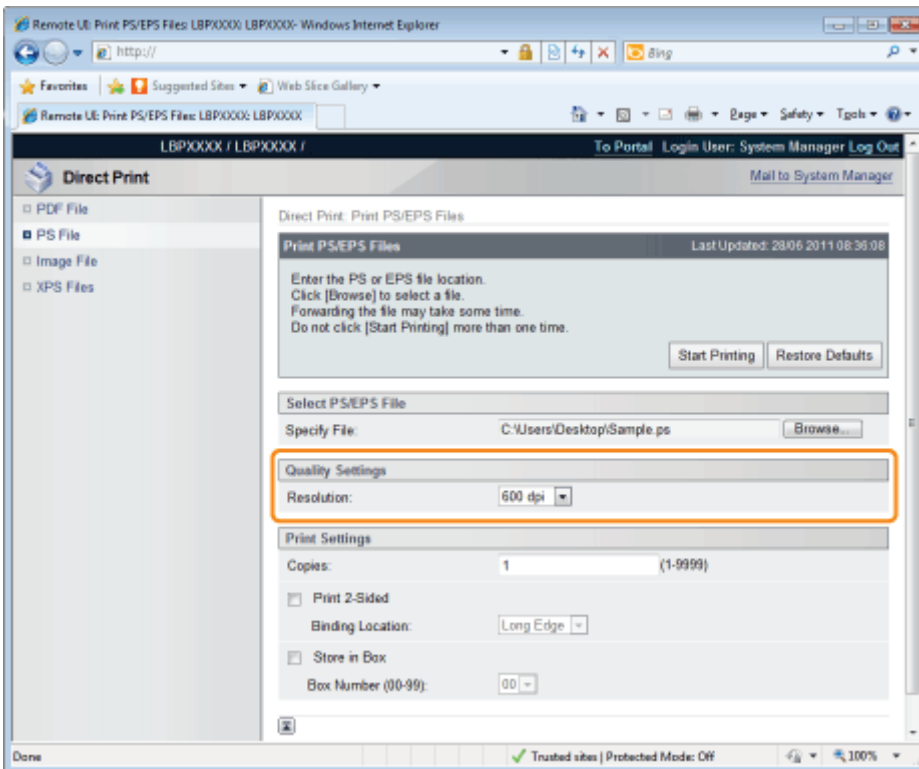

[Resolution]	Specify the resolution for printing the data. It is effective to set [600 dpi] when printing photographs at standard quality, and to set [1200 dpi] when printing at a higher quality.
--------------	--

5 Specify the settings for [Print Settings] as the following, as needed.

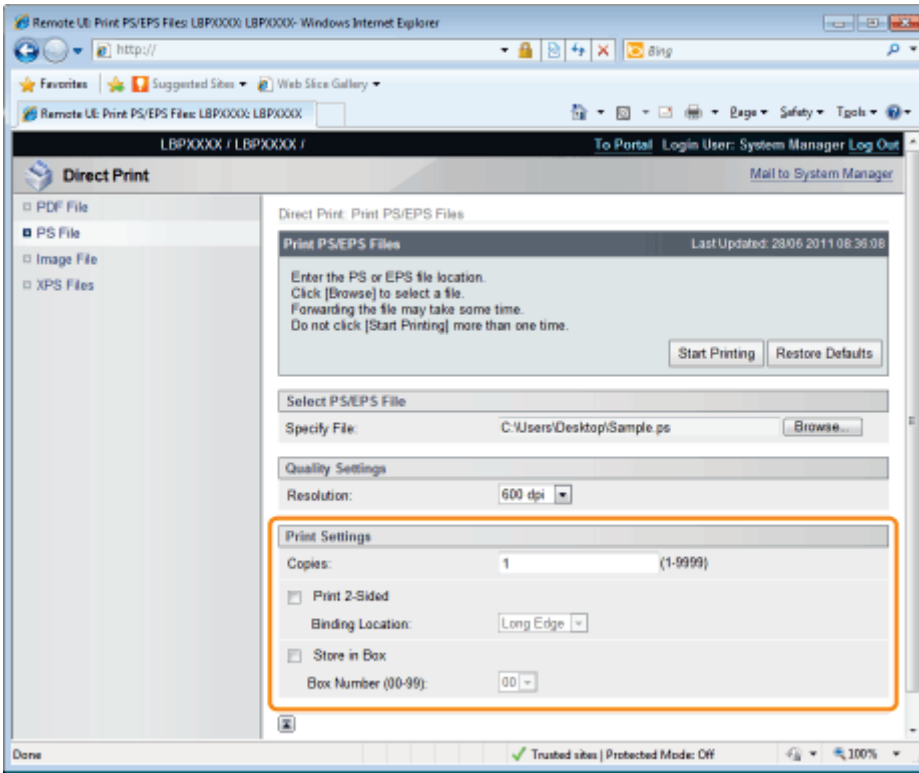

[Copies]	Specify the number of copies to be printed.
[Print 2-Sided]	Specify 1-sided or 2-sided printing.
[Binding Location]	Set the binding position on the long side of the paper (long-edged binding) or the short side of the paper (short-edged binding). If binding is set from the printer side, the position of the "gutter" is automatically adjusted on the front and back sides of the paper.
[Store in Box]	(It is only displayed when an SD card is used.) When storing it in a box, check the [Store in Box] check box before selecting the box where you want to store it.

6

Click [Start Printing].

- † Do not keep clicking [Start Printing] while the file is transferring. Sometimes it takes time to transfer a file, but if you keep clicking during the transfer, a file failure may occur and it may be impossible to transfer it.

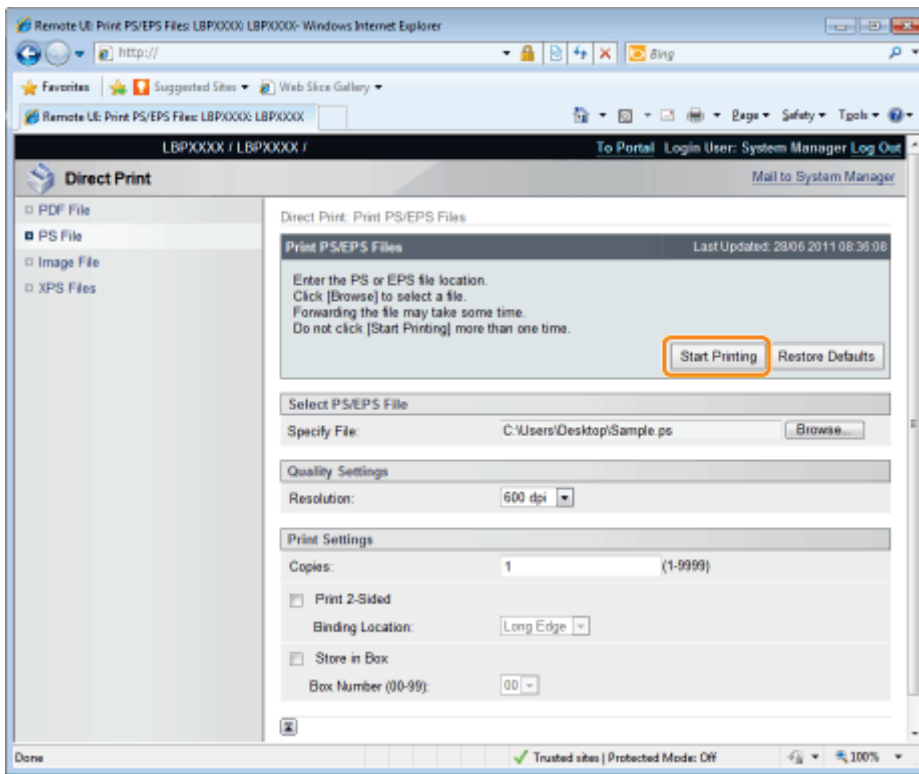

→ When the print job has finished sending, the display switches and the following message is displayed.

Press [To Job List] to check the print job that was sent.

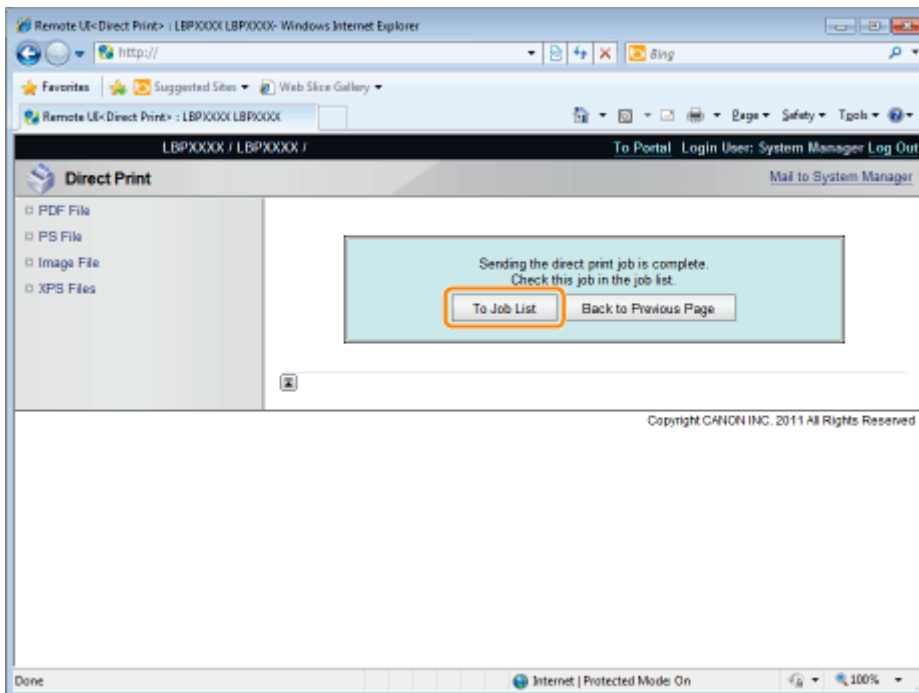

Printing the TIFF/JPEG File Using the Direct Print Function

04L9-06E

1

Start the Remote UI.

➤ "Starting the Remote UI"

2

Select [Image File] from the [Direct Print] menu.

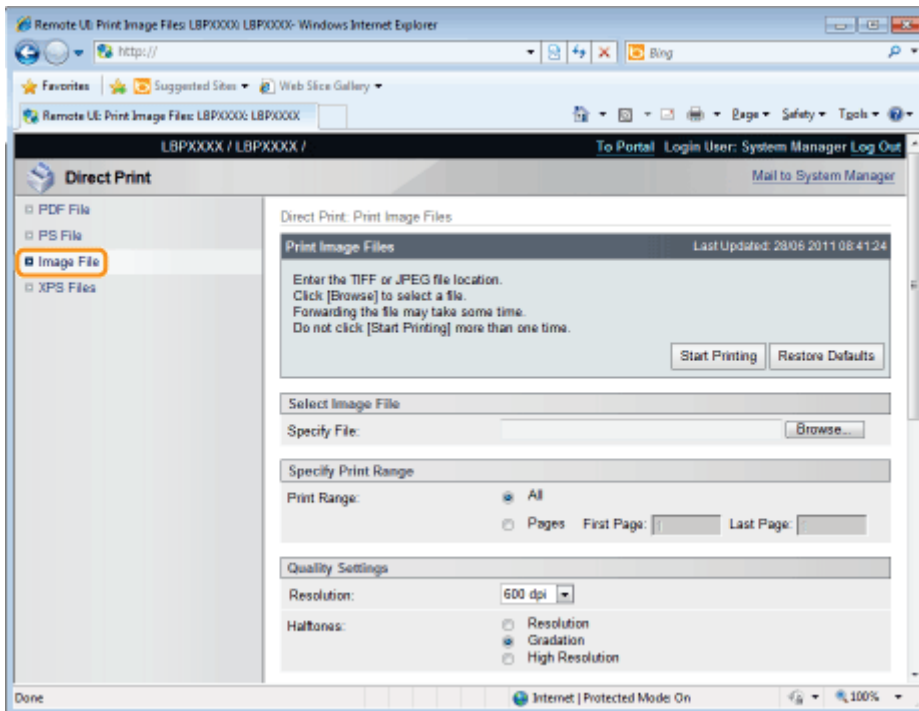

3

Specify [Select Image File].

Click [Browse...], select the file, and then click [Open...].

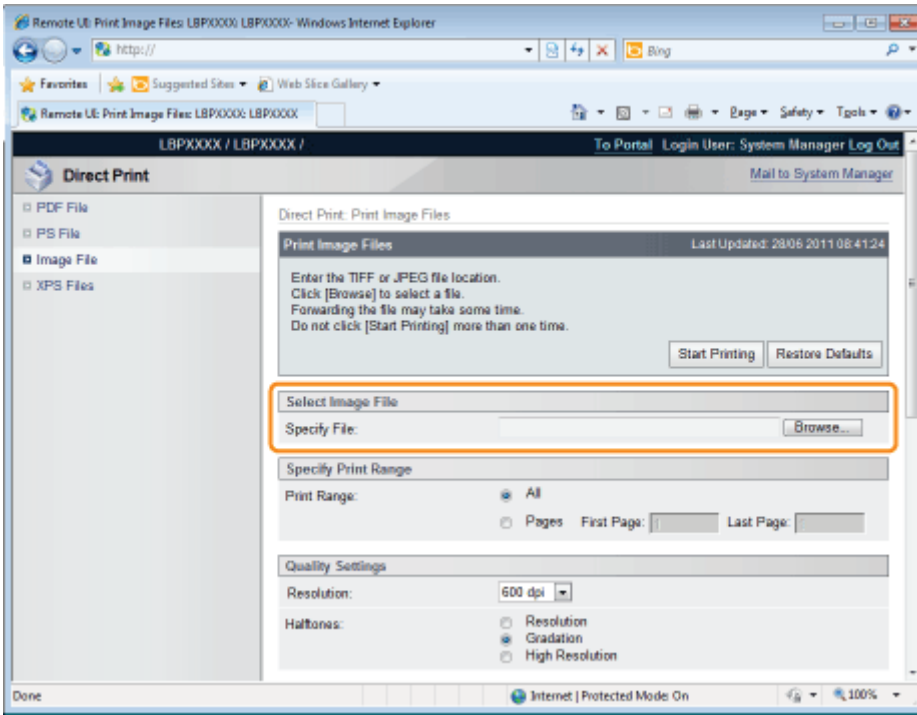

4

Specify the setting for [Specify Print Range].

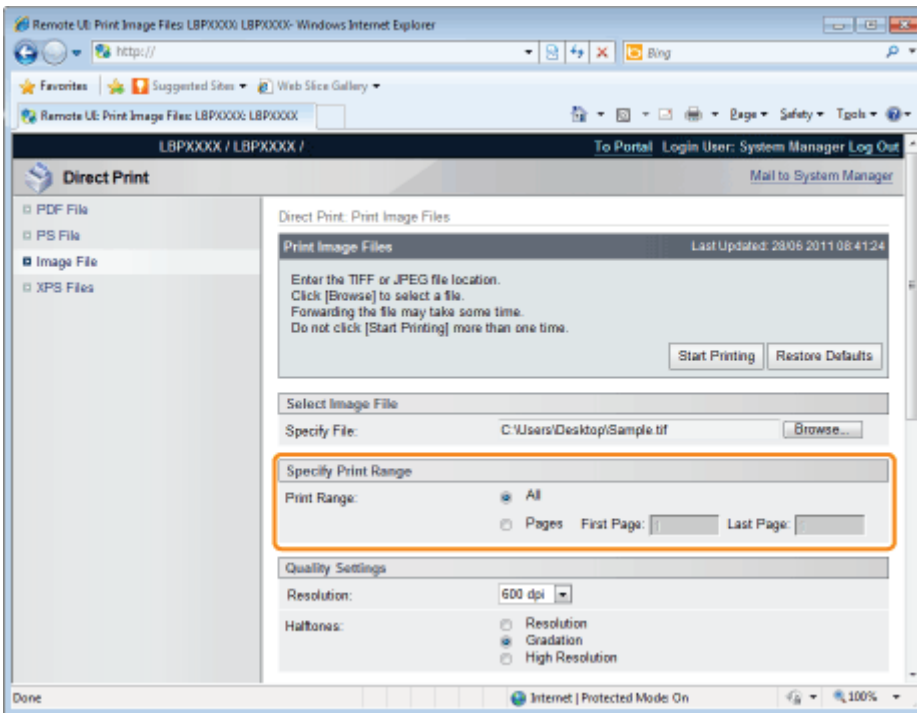

[All]	Select if you want to print all the pages.
[Pages]	Select [Pages], and then enter the starting page number and ending page number if you want to specify the print range.

5

Specify the setting for [Quality Settings].

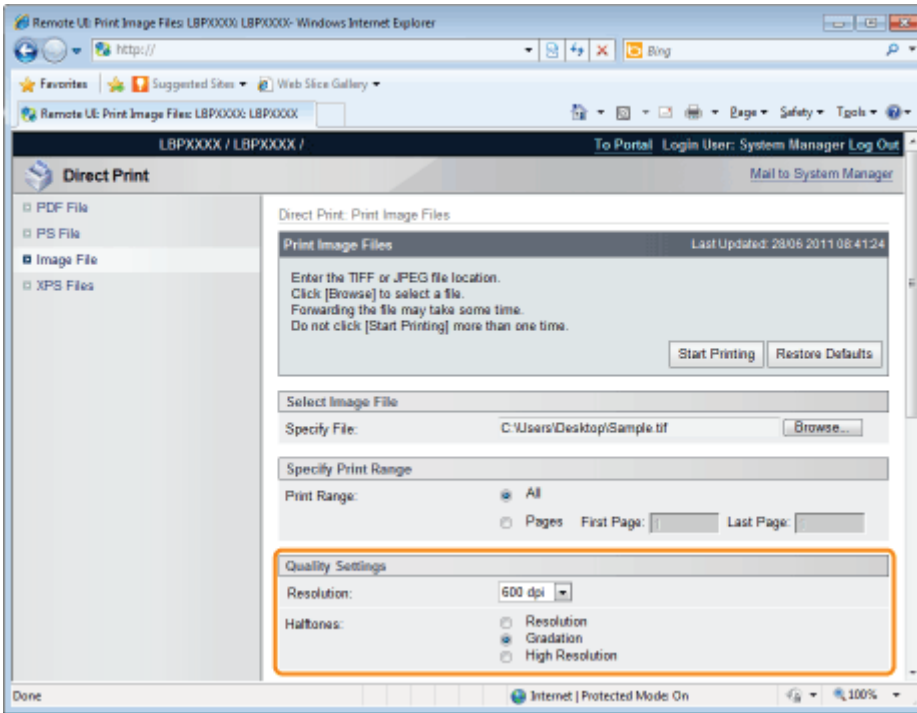

[Resolution]	Specify the resolution for printing the data. It is effective to set [600 dpi] when printing photographs at standard quality, and to set [1200 dpi] when printing at a higher quality.
[Halftones]	<p>Specify the halftone display method when printing.</p> <p>[Resolution]: You can perform printing that combines smooth gradation with edge quality. It is suitable for printing graphics or graphs that use gradation.</p> <p>[Gradation]: You can print with a sharp gradation and well-balanced texture, contrasting light and shade, which is best suited for printing photo images.</p> <p>[High Resolution]: You can print in fine detail so that the edges of text data can be seen clearly. It is suitable for printing data containing text and fine lines.</p>

6

Specify the setting for [Color Settings].

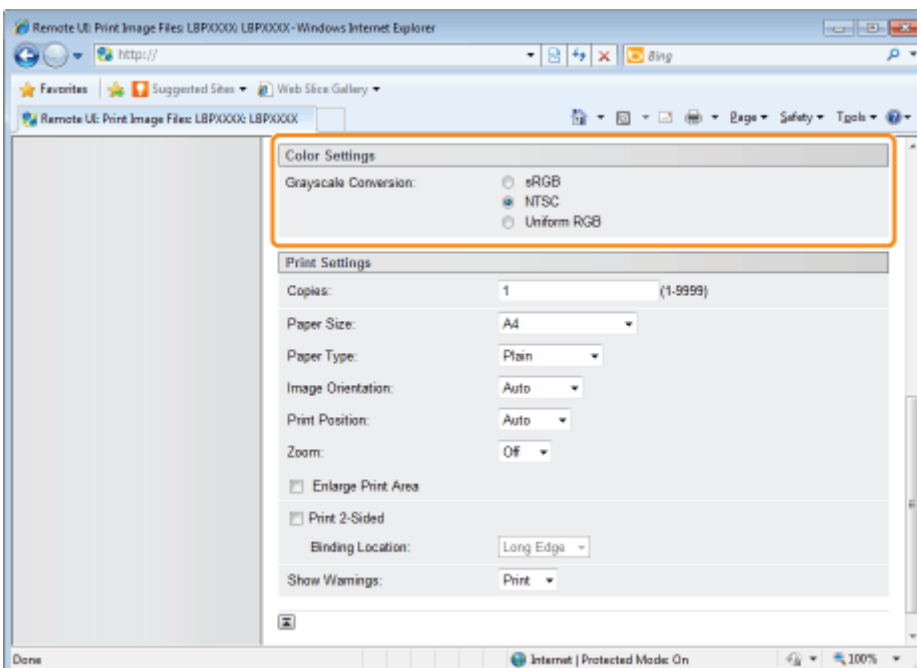

[Grayscale Conversion]

Select the method for converting color print data to grayscale for printing.

- This setting is for converting color data to B&W data.

[sRGB]: It calculates the grayscale value using the sRGB standard color conversion method.

[NTSC]: It calculates the grayscale value using the NTSC standard color conversion method.

[Uniform RGB]: It takes the average value of the Red, Green and Blue color values as the grayscale value.

7

Specify the settings for [Print Settings] as the following, as needed.

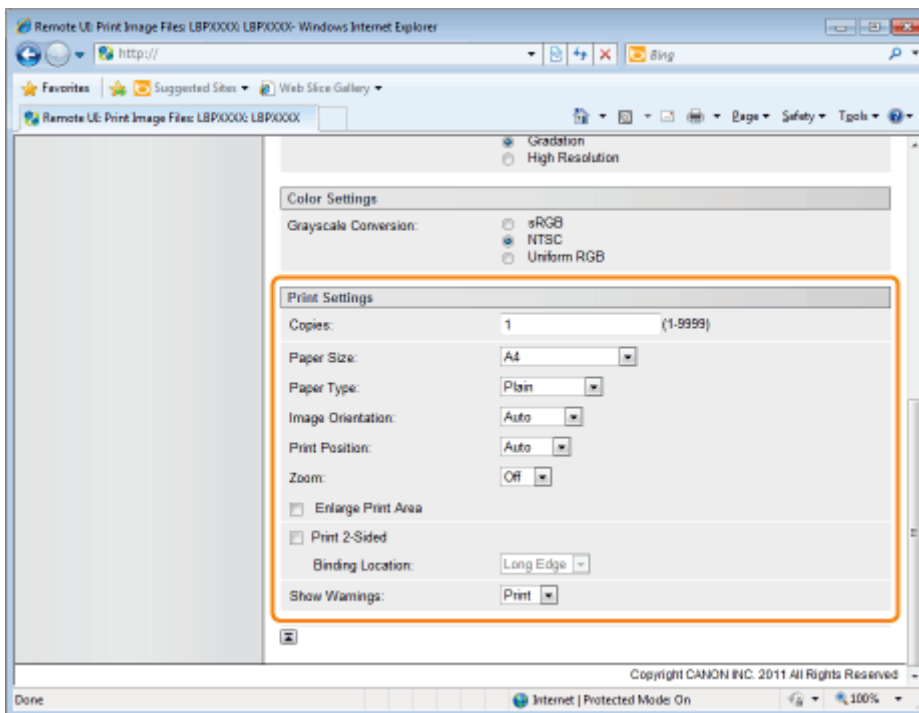

[Copies]	Specify the number of copies to be printed.
[Paper Size]	Specify the size of paper to print.
[Paper Type]	Specify the type of paper to print.
[Image Orientation]	Select the orientation of the images from [Auto], [Vertical] or [Horizontal].
[Print Position]	Set the location of the images from [Auto], [Center] or [Top Left]. When [Auto] is selected, if the print location is specified in the TIFF format data, it will print at the specified location. If the print location is not set, it will print centered. Since print location is not specified in JPEG format, if [Auto] is selected, it will print centered.
[Zoom]	Specify whether to enlarge or reduce the printing. When it is set to [Auto], it automatically scales them to match with the effective print area of the paper and prints.
[Enlarge Print Area]	Specify whether to expand the printable area and print. <ul style="list-style-type: none"> • Depending on the document to be printed, part of the edges of the paper may not be printed.
[Print 2-Sided]	When it is set, it will print 2-sided.
[Binding Location]	Set the binding position on the long side of the paper (long-edged binding) or the short side of the paper (short-edged binding). If binding is set from the printer side, the position of the "gutter" is automatically adjusted on the front and back sides of the paper.

[Show Warnings]

You can select a job processing method for when it detects an Imaging function error.

- When it is set to [Print], the error description list is printed at the same time.

[Print] The error description is printed on the paper and the job is terminated.

[Panel] The error message is displayed on the printer's display, and printing stops.

[Off] Even if an error occurs and nothing is displayed, the job is terminated.

8

Click [Start Printing].

- † Do not keep clicking [Start Printing] while the file is transferring. Sometimes it takes time to transfer a file, but if you keep clicking during the transfer, a file failure may occur and it may be impossible to transfer it.

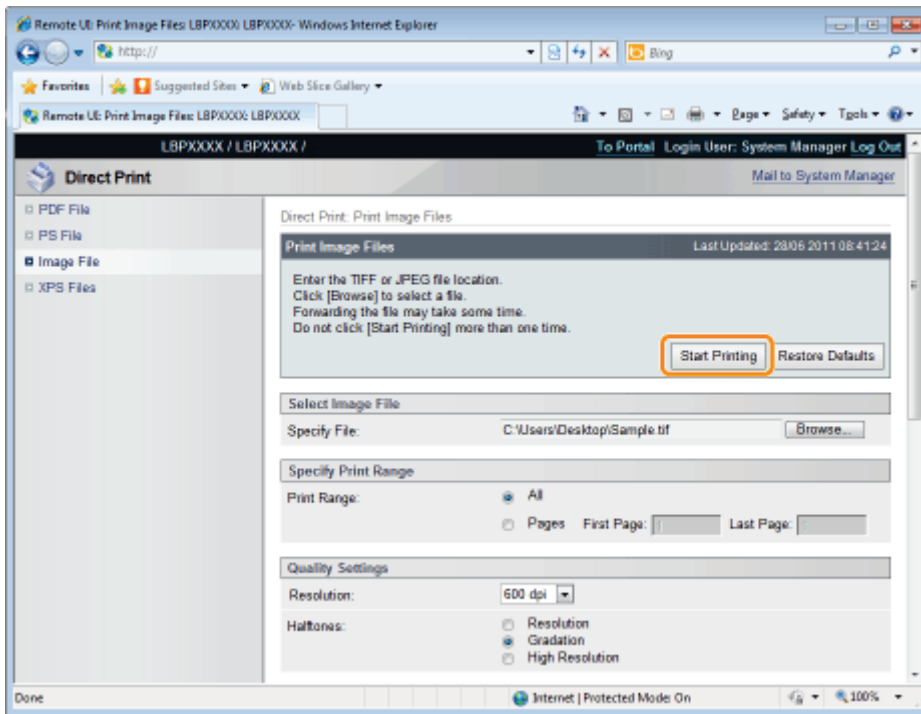

→ When the print job has finished sending, the display switches and the following message is displayed.

Press [To Job List] to check the print job that was sent.

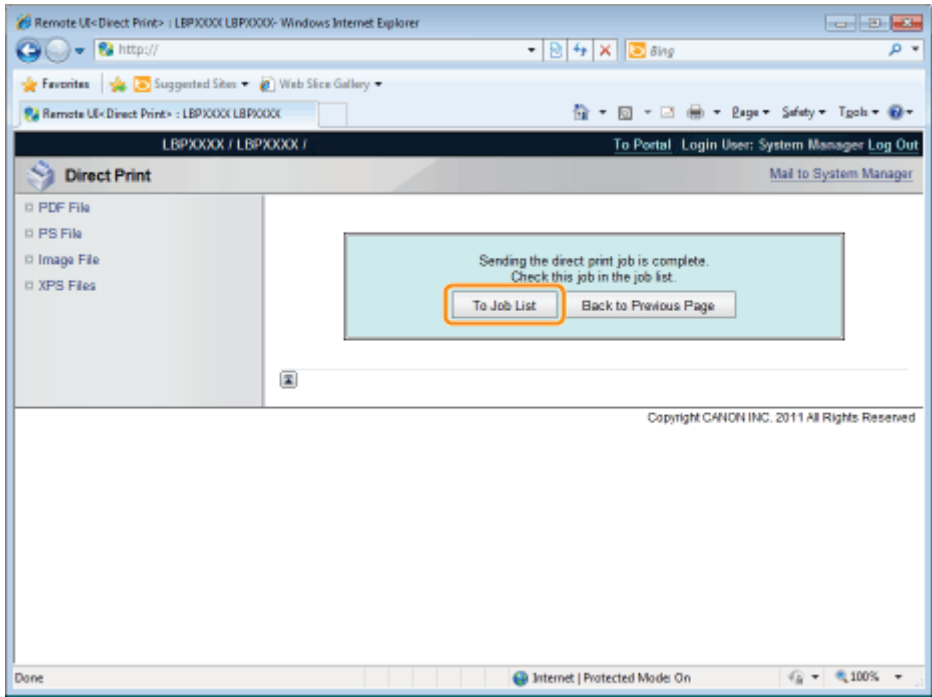

1

Start the Remote UI.

- "Starting the Remote UI"

2

Select [XPS Files] from the [Direct Print] menu.

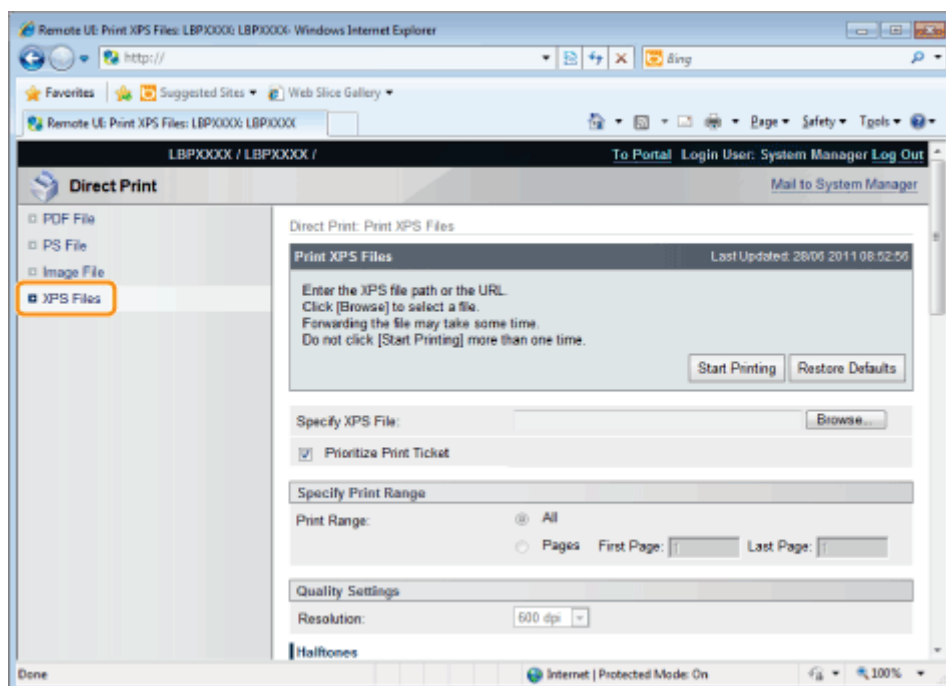

3

Specify [Specify XPS File].

- (1) Click [Browse...], select the file, and then click [Open...].
 - (2) Clear the [Prioritize Print Ticket] check box.
- † If the [Prioritize Print Ticket] check box is selected, some items cannot be set via the Remote UI. To use all the print settings made via the Remote UI, clear the [Prioritize Print Ticket] check box.

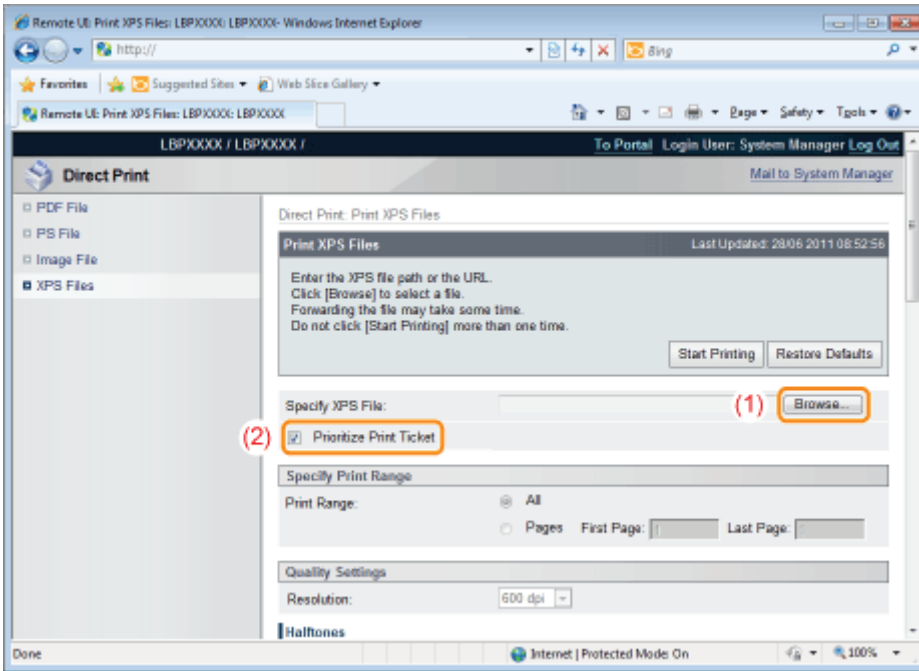

4

Specify the setting for [Specify Print Range].

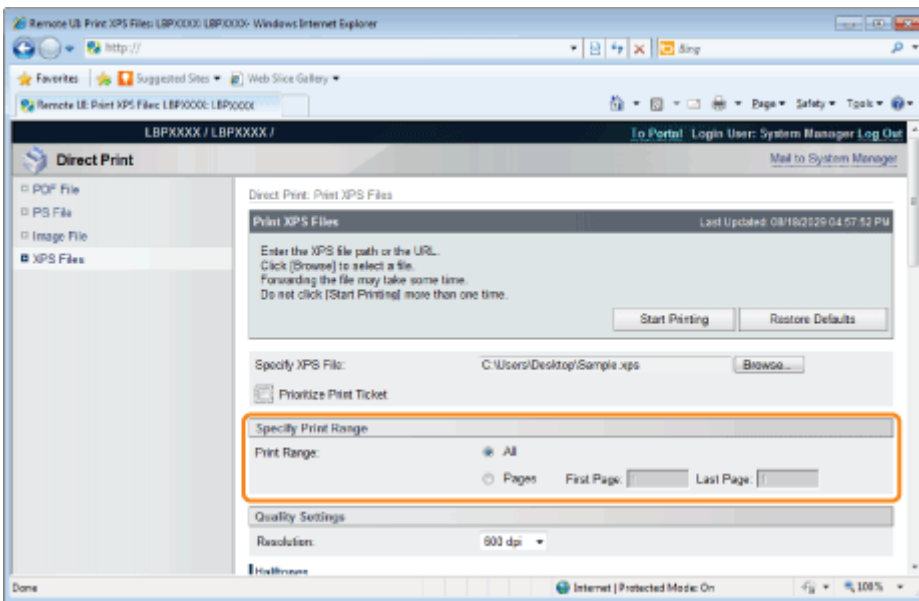

[All]	Select if you want to print all the pages.
[Pages]	Select [Pages], and then enter the starting page number and ending page number if you want to specify the print range.

5

Specify the settings for [Quality Settings] as the following, as needed.

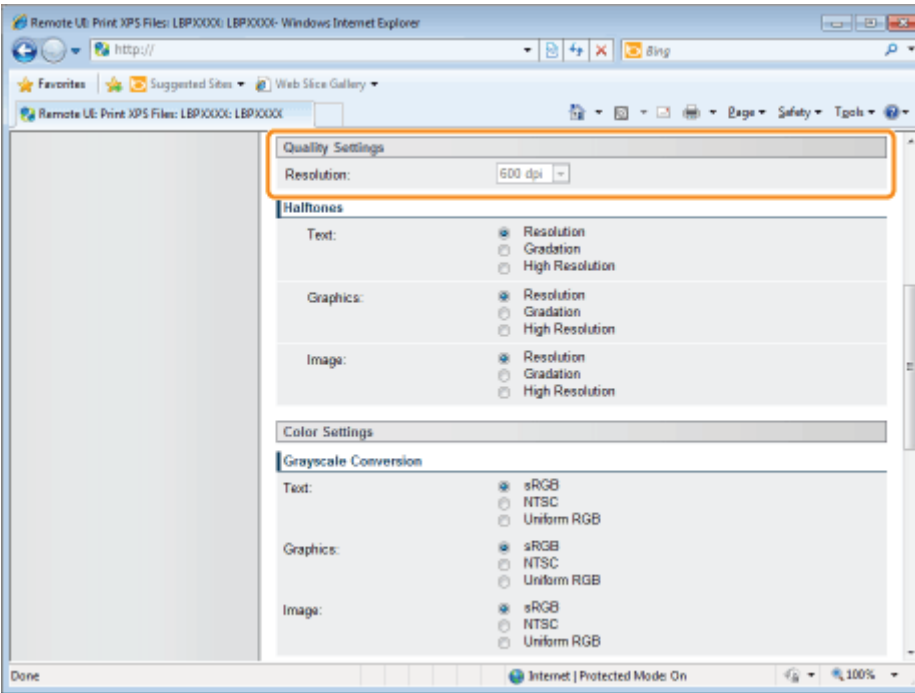

[Resolution]	Specify the resolution for printing the data. It is effective to set [600 dpi] when printing photographs at standard quality, and to set [1200 dpi] when printing at a higher quality.
--------------	--

6

Specify the settings for [Halftones] as the following, as needed.

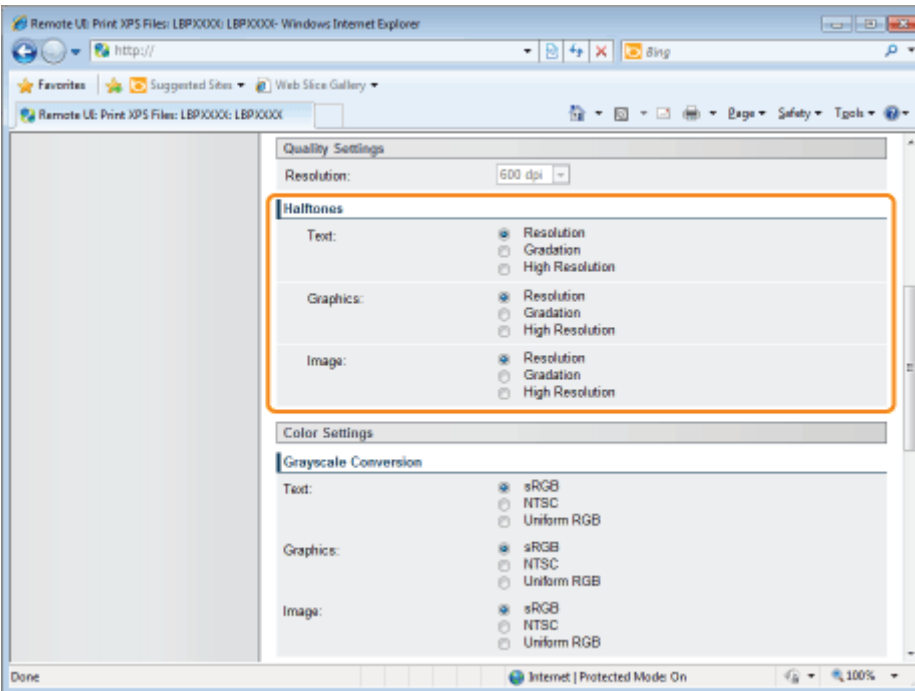

[Halftones]	<p>Specify the halftone display method when printing. You can set it for these data types: [Text], [Graphics] or [Image].</p> <p>[Resolution] You can perform printing that combines smooth gradation with edge quality. It is suitable for printing graphics or graphs that use gradation.</p> <p>[Gradation] You can print with a sharp gradation and well-balanced texture, contrasting light and shade, which is best suited for printing photo images.</p> <p>[High Resolution] You can print in fine detail so that the edges of text data can be seen clearly. It is suitable for printing data containing text and fine lines.</p>
-------------	--

7

Specify the settings for [Color Settings] as the following, as needed.

<p>[Grayscale Conversion]</p>	<p>Select the method for converting color print data to grayscale for printing.</p> <ul style="list-style-type: none"> You can set it for these data types: [Text], [Graphics] or [Image]. This setting is for converting color data to B&W data. <p>[sRGB]: It calculates the grayscale value using the RGB standard color conversion method.</p> <p>[NTSC]: It calculates the grayscale value using the NTSC standard color conversion method.</p> <p>[Uniform RGB]: It takes the average value of the Red, Green and Blue color values as the grayscale value.</p>
-------------------------------	---

8

Specify the settings for [Print Settings] as the following, as needed.

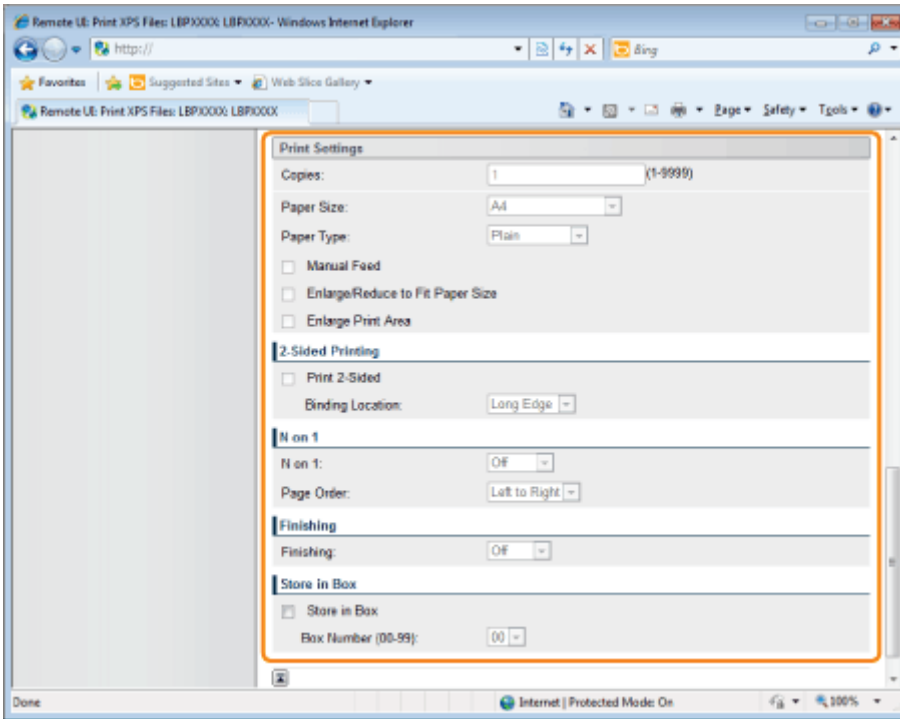

<p>[Copies]</p>	<p>Specify the number of copies to be printed.</p>
<p>[Paper Size]</p>	<p>Specify the size of paper to print. If data is input that is outside the engine's maximum and minimum paper size range when the paper size is automatic, it is printed on the paper size that is set with [Standard Paper Size].</p> <p>[Auto]: It selects the most suitable paper source for the XPS file page size, and prints.</p> <p>Other than [Auto]: It prints so that the long side of the XPS file and the long side of the selected paper size go in the same direction.</p>
<p>[Paper Type]</p>	<p>Specify the type of paper to print.</p>
<p>[Manual Feed]</p>	<p>You can fix the paper source in the multi-purpose tray.</p>

[Enlarge/Reduce to Fit Paper Size]	If the check box is selected, it fixes the aspect ratio and scales it to fit with the effective print area of the paper size that is set and prints. However if [Paper Size] is set as [Auto], this item cannot be set.
[Enlarge Print Area]	Specify whether to expand the printable area and print. <ul style="list-style-type: none"> Depending on the document to be printed, part of the edges of the paper may not be printed.
[Print 2-Sided]	Specify 1-sided or 2-sided printing.
[Binding Location]	Set the binding position on the long side of the paper (long-edged binding) or the short side of the paper (short-edged binding). If binding is set from the printer side, the position of the "gutter" is automatically adjusted on the front and back sides of the paper.
[N on 1]	You can print multiple pages of the XPS file data arranged on one page. <ul style="list-style-type: none"> When printing multiple pages side by side, set [Paper Size] to a setting other than [Auto].
[Page Order]	The [N on 1] setting enables you to set the order the pages will be arranged on the paper when printing multiple pages on one page.
[Finishing]	(It is only displayed when an SD card is used.) It collates and prints in page or section units. <p>[Off]: Print the number of copies specified for every page.</p> <p>[Collate]: The specified number of copies are collated.</p>
[Store in Box]	(It is only displayed when an SD card is used.) When storing it in a box, check the [Store in Box] check box before selecting the box where you want to store it.

9

Click [Start Printing].

† Do not keep clicking [Start Printing] while the file is transferring. Sometimes it takes time to transfer a file, but if you keep clicking during the transfer, a file failure may occur and it may be impossible to transfer it.

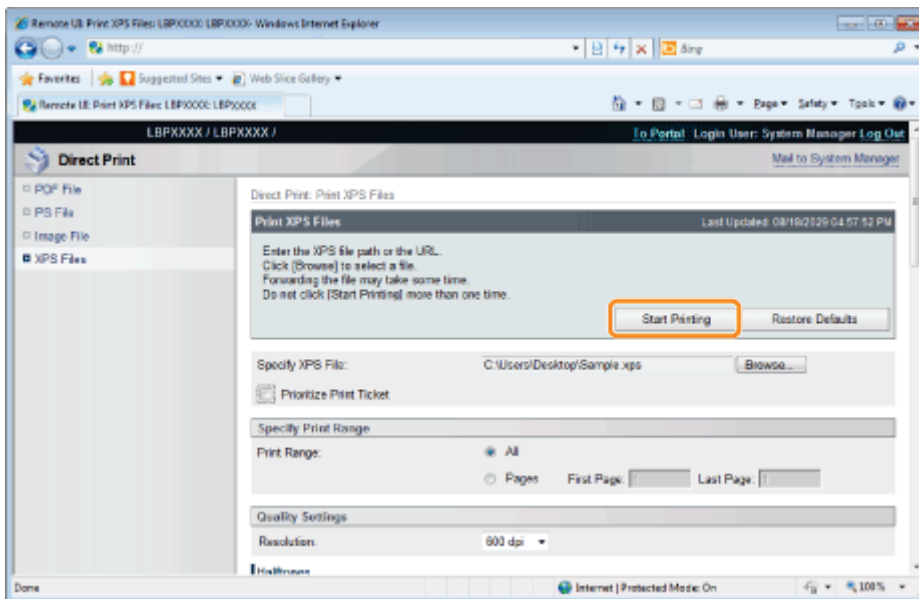

→ When the print job has finished sending, the display switches and the following message is displayed.

Press [To Job List] to check the print job that was sent.

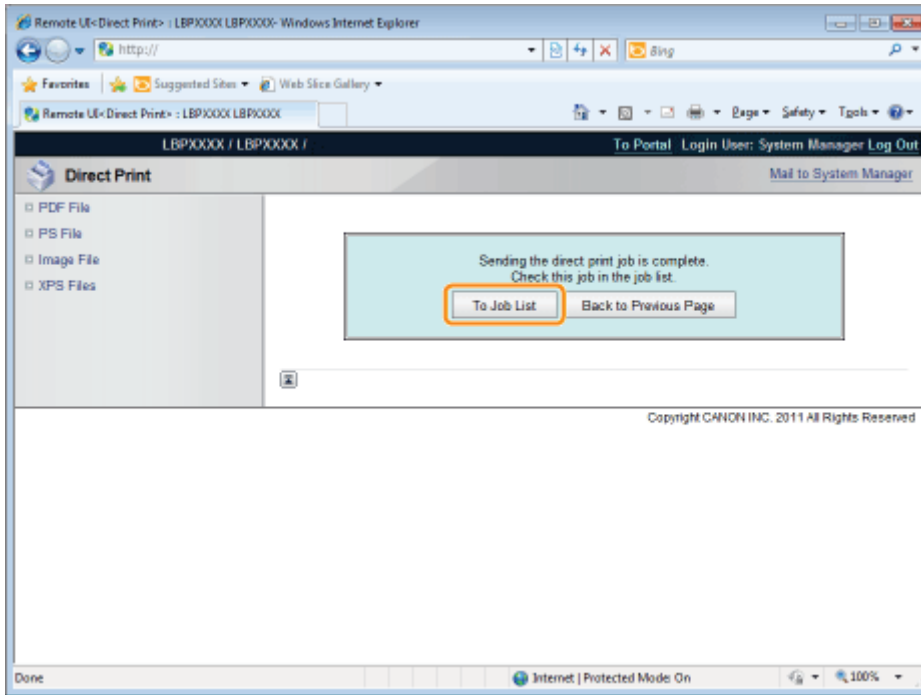

Direct Printing from Command Prompt

04L9-06H

The command of the following format is effective.

`lpr (a space) -S (a space) <the IP address of the printer> (a space) -P (a space) <the printer name> (a space) <the file name>`

The printer name	Enter the printer name. You can check the printer name in [Device Name] on the Remote UI portal page.
The file name	Enter the name of the file to be printed.

- **Input Example**

<If the IP address of the printer is "192.168.0.215", if the printer name is "LBP-Printer", and if the file name is "sample.jpg">

`lpr -S 192.168.0.215 -P LBP-Printer sample.jpg`

 **NOTE**

The settings which can be used for Direct Print

The settings specified using the printer's control panel become effective. You can use the following [Setup] menus.

- "[Setup] Menu ([Control Menu] Options)"
- "[Setup] Menu ([Paper Source] Options)"
- "[Setup] Menu ([Layout] Options)"
- "[Setup] Menu ([Quality] Options)"
- "[Setup] Menu ([Imaging] Options)"
- "[Setup] Menu ([XPS] Options) (LBP6680x Only)"
- "[Setup] Menu ([PDF] Options)"
- "[Setup] Menu ([PS] Options)"

Printing Files Directly from USB Memory Devices (USB Direct Print) (LBP6680x Only)

04L9-06J

You can print data in USB memory device directly from the machine. Because it is possible to print without a computer, you can easily print data stored in a USB memory device at a location where the machine is installed. This makes immediate handling possible when printed documents are needed quickly.

➤ Printing Directly from USB Memory Device

You can print files directly from a USB memory device that is connected to the printer.

➤ Print Setting Menu List

You can change the settings when printing.

➤ Changing the Default Print Settings and File Sorting Criteria



You can change the default print settings and default file display sorting criteria. Settings that are often used can be conveniently set in advance as defaults.

➤ Remove the USB Memory Device

Remove the USB memory device after printing has stopped. Use the correct method to remove the USB memory device.

IMPORTANT

In order to use USB memory devices, the following settings are necessary.

- Set [MEAP Driver] to [Off]
 - (1) Press [] ( : Settings), select [Interface] with [▲] and [▼], and then press [OK].
 - (2) Select [Interface Selection] with [▲] and [▼], and then press [OK].
 - (3) Select [USB Storage Device] with [▲] and [▼], and then press [OK].
 - (4) Select [MEAP Driver] with [▲] and [▼], and then press [OK].
 - (5) Select [Off] with [▲] and [▼], and then press [OK].
 - Enable [USB Direct Print] under [USB Direct Print Settings] in the Remote UI.
- ["Setting Restrictions for USB Direct Print \(LBP6680x Only\)"](#)

About USB memory support

- The file format FAT32 is supported only.
- USB memory drives cannot be read by this printer if:
 - these drives are partitioned
 - these drives contain encrypted data

Printing Directly from USB Memory Device

04L9-06K

1

Insert the USB memory device in the USB memory slot on the printer.

2

Press [] ( : Application).

The "USB Direct Print Mode Screen" is displayed.

† When department ID management is set, the screen is displayed when the departmental ID and PIN are entered. After entering the department ID and PIN, select [<Log In>], and then press [OK].

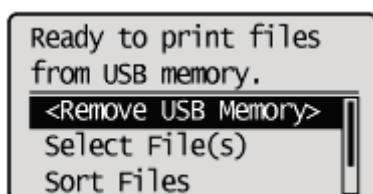

NOTE

In order to automatically display the USB direct print mode screen

When the [Automatically Display USB Direct Print Screen] setting is checked on [USB Direct Print] in the [USB Direct Print Settings] on the Remote UI, the "USB Direct Print Mode Screen" is displayed automatically when a USB memory device is inserted.

[▶ "Starting the Remote UI"](#)

3

Select [Select File(s)] with [▲] and [▼], and then press [OK].

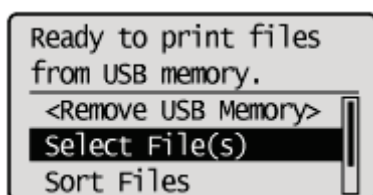

Changing the order of the files displayed in Step 5

(1) Select [Sort Files] with [▲] and [▼], and then press [OK].

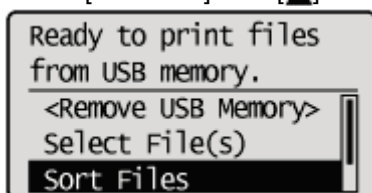

(2) Since the message is displayed, press [OK].

(3) Select the sorting criteria with [▲] and [▼], and then press [OK].

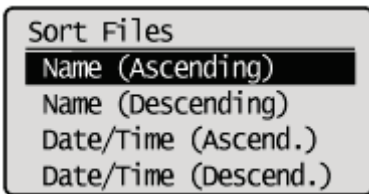

4

Select the type of file to print with [▲] and [▼], and then press [OK].

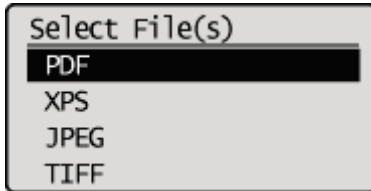

5

Select the file to print with [▲] and [▼], and then press [OK].

† [] will be attached to the file name. If a file with [] attached is selected, and [OK] is pressed again, the selection is removed.

If a folder is selected, and [OK] is pressed, the list of files inside the folder is displayed.

If [<Clear All>] is selected, all the file selections are removed.

† Up to 10 files in the same folder can be selected.

† If the folder hierarchy is moved, all of the file selections are removed.

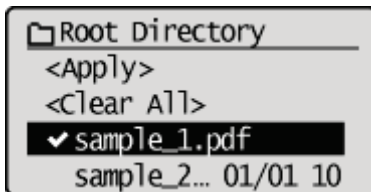

6

Select [<Apply>] with [▲] and [▼], and then press [OK].

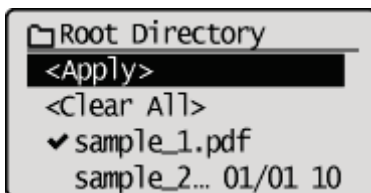

When printing using an XPS file print ticket

(1) Select [<Use Print Ticket>] with [▲] and [▼], and then press [OK].

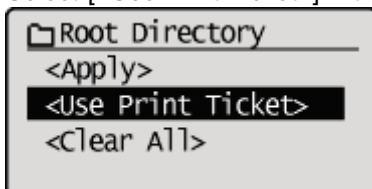

(2) Select [<Start Printing>] with [▲] and [▼], and then press [OK].

It is printed using the print settings specified inside the file.

7

Select [<Start Printing>] with [▲] and [▼], and then press [OK].

↑ To confirm/ change the print settings, select the setting to be confirmed/changed with [▲] and [▼], and then press [OK]. For details on print settings, see "[Print Setting Menu List](#)."

The selected file begins printing.

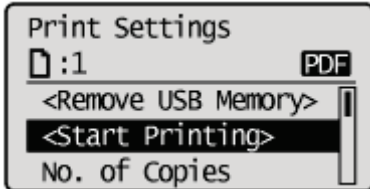

 Remove the USB memory device after printing has finished.
➤ "[Remove the USB Memory Device](#)"

Print Setting Menu List

04L9-06L

You can set the following items when printing.

NOTE

Viewing the Tables

- The default value for each setting is displayed in bold text. To change the default values, see "[Changing the Default Print Settings and File Sorting Criteria.](#)"
- The items and setting values marked with "*" may or may not be displayed depending on the availability of the optional accessories or the content of the setting.

Items that can be set for all file formats

Setting Item	Setting Value	Setting
[Resolution]	[1200 dpi] / [600 dpi]	You can specify the resolution before making a print. [600 dpi]: Prints with 600 dpi resolution. Suitable for printing regular files and tables. [1200 dpi]: Prints with 1200 dpi resolution. Enables you to clearly print fine text and diagrams. Particularly suitable for data that includes a lot of small text or fine lines.
[No. of Copies]	1 to 9999	Specify the number of copies to be printed. Only the number of copies specified by the setting value are printed.
[2-Sided Printing]	[Off] / [On]	Specify whether to print on one side or both sides of the paper. <ul style="list-style-type: none"> • When it is set to [On], it prints on both sides of the paper.
[Binding Location]	[Long Edge] / [Short Edge]	It sets the binding location on the long side of the paper (long-edged binding) or the short side of the paper (short-edged binding). During 2-sided printing, the binding location is automatically adjusted on both the front and back sides. <ul style="list-style-type: none"> • When it is set to [Long Edge], the binding location is on the long side of the paper. • When it is set to [Short Edge], the binding location is on the short side of the paper.
[Enlarge Print Area]	[Off] / [On]	Specify whether to expand the printable area and print. <ul style="list-style-type: none"> • When it is set to [On], the printable area is expanded and printed. • When it is set to [Off], the effective print area becomes that area except for 5mm at the top, bottom right and left edges. <p>† When it is set to [On], images on the edges of the paper may be partially cut off.</p>

Items that can be set for PDF/XPS formats

Setting Item	Setting Value	Setting
[Print Range]	[Designation Method] : [All] / [Specified Pages] [Page Range] : [First Page] / [Last Page]	Specify the print range. Only the range specified by the setting value is printed. <ul style="list-style-type: none"> • When [All] is selected, all the pages are printed. • When [Specified Pages] is selected, and the page range is entered, only the specified page range is printed. If the page range is selected, select [<Apply>], and then press [OK]. <p>† [Page Range] is only displayed when [Specified Pages] is selected in [Designation Method].</p>

[Select Paper]	[Auto] / [Multi-Purpose Tray] / [Drawer 1] / [Drawer 2]*	Specify the size of paper to output. <ul style="list-style-type: none"> When it is set to [Auto], it selects the most suitable paper source for the page size of the file to be printed, and prints. When it is not set to [Auto], it prints so that the long side of the page size of the file to be printed and the long side of the selected paper size go in the same direction.
[Halftones]	[Resolution/Gradation/High Resolution] : [Text] / [Graphics] / [Image] [Text] : [Resolution] / [Gradation] / [High Resolution] [Graphics] : [Resolution] / [Gradation] / [High Resolution] [Image] : [Resolution] / [Gradation] / [High Resolution]	Specify the halftone display method when printing. You can set [Resolution/Gradation/High Resolution] as [Text], [Graphics] or [Image] for these data types. <ul style="list-style-type: none"> [Resolution] allows you to perform printing that combines smooth gradation with edge quality. It is suitable for printing graphics or graphs that use gradation. [Gradation] allows you to print with a sharp gradation and well-balanced texture, contrasting light and shade, which is best suited for printing photo images. [High Resolution] allows you to print in fine detail so that the edges of text data can be seen clearly. It is suitable for printing data containing text and fine lines.
[Match Paper Size]	[Off] / [On]	When it is set to [On], it automatically scales them to match with the effective print area of the output paper and prints. However, if the [Select Paper] setting on the printer for is set to [Auto], this setting is not available.
[N on 1]	[Off] / [2 on 1] / [4 on 1] / [6 on 1] / [8 on 1] / [9 on 1] / [16 on 1]	You can print multiple pages of the file data to be printed arranged on one page. <ul style="list-style-type: none"> ↑ When printing multiple pages side by side, set [Select Paper] to a setting other than [Auto].
[Finishing]	[Off] / [Collate]	Specify the finishing options. <ul style="list-style-type: none"> When it is set to [Off], the number of copies set for each page is printed. when it is set to [Collate], the specified number of copies are collated.

Items that can be set for JPEG/TIFF formats



Setting Item	Setting Value	Setting
[Print Range (TIFF)]	[Designation Method] : [All] / [Specified Pages] [Page Range] : [First Page] / [Last Page]	Specify the print range. Only the range specified by the setting value is printed. <ul style="list-style-type: none"> When [All] is selected, all the pages are printed. When [Specified Pages] is selected, and the page range is entered, only the specified page range is printed. If the page range is selected, select [<Apply>], and then press [OK]. <ul style="list-style-type: none"> ↑ [Page Range] is only displayed when [Specified Pages] is selected in [Designation Method].
[Select Paper]	[Multi-Purpose Tray] / [Drawer 1] / [Drawer 2]*	Specify the paper size for printing. <ul style="list-style-type: none"> Print with the paper size specified for the selected paper source. <ul style="list-style-type: none"> ↑ You cannot select the paper source for which a custom paper size is specified.
		Specify the halftone display method when printing. <ul style="list-style-type: none"> [Resolution] allows you to perform printing that combines smooth gradation with edge quality. It is suitable for printing graphics or graphs that use gradation.

[Halftones]	[Resolution] / [Gradation] / [High Resolution]	<ul style="list-style-type: none"> • [Gradation] allows you to print with a sharp gradation and well-balanced texture, contrasting light and shade, which is best suited for printing photo images. • [High Resolution] allows you to print in fine detail so that the edges of text data can be seen clearly. It is suitable for printing data containing text and fine lines.
[Zoom]	[Off] / [Auto]	<p>Specify whether to enlarge or reduce the printing.</p> <ul style="list-style-type: none"> • When it is set to [On], it automatically scales them to match with the effective print area of the output paper and prints.
[Image Orientation]	[Auto] / [Vertical] / [Horizontal]	Specify whether to print the image vertically or horizontally.
[Print Position]	[Auto] / [Center] / [Top Left]	Specify the location where the image will be printed.

Changing the Default Print Settings and File Sorting Criteria

04L9-06R

1

Press [] ( : Application).

The "USB Direct Print Mode Screen" is displayed.

† When department ID management is set, the screen is displayed when the departmental ID and PIN are entered. After entering the department ID and PIN, select [<Log In>], and then press [OK].

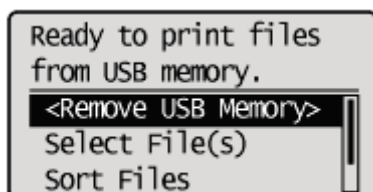

2

Select [USB Print Settings] with [▲] and [▼], and then press [OK].

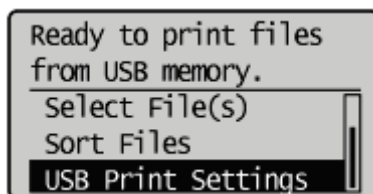

3

Select items for which to set default values using [▲] or [▼], and then press [OK].

Set default print settings

- (1) Select [PDF/XPS Default Set.] or [JPEG/TIFF Def. Set.] using [▲] or [▼], and then press [OK].
- (2) Set the default value of each item.
For details on the settings, see "[Print Setting Menu List.](#)"

Setting default values for file display sorting criteria

- (1) Select [File Sort Def. Set.] with [▲] and [▼], and then press [OK].
- (2) Select the default sorting criteria using [▲] or [▼], and then press [OK].

Remove the USB Memory Device

04L9-06S

IMPORTANT

When removing USB memory devices



Always use the following procedure when removing USB memory devices.

Using other methods to remove USB memory devices may result in damage to the device and the printer.

The following procedure is explained when the "USB Direct Print Mode Screen" is displayed. Remove the USB memory device using the same procedure even when the "Printer Setup Screen" is displayed.

1

Display the "USB Direct Print Mode Screen" or the "Printer Setup Screen."

When other screens are displayed, press [] (↶ : Back) or [] ( : Application) until the "USB Direct Print Mode Screen" or the "Printer Setup Screen" is displayed.

2

Select [<Remove USB Memory>] with [▲] and [▼], and then press [OK].

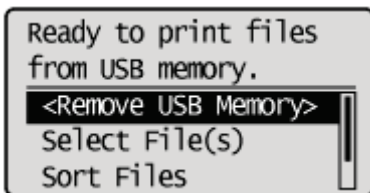

3

Select [Yes] with [▲] and [▼], and then press [OK].

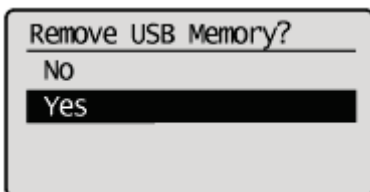

4

When the following message is displayed, remove the USB memory device from the printer.

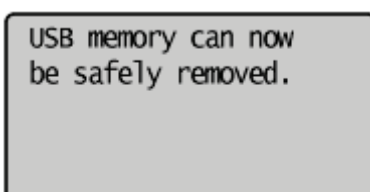

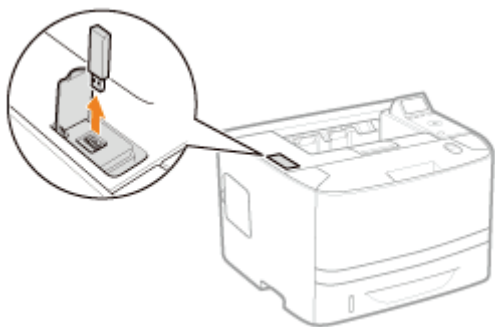

If an error message is displayed, wait a few seconds before starting the removal procedure again from the beginning.

Cannot remove USB
memory because it
is being accessed.
Wait a moment, then
try again.

Receiving E-mail Data on the Mail Server and Printing (E-mail Print)

04L9-06U

E-mail print is a function in which this printer receives e-mails sent from the host terminal and prints the text as well as the attached files. Therefore, you do not need to use a printer driver or open the attached files to print.

Available Protocol	Requirements
POP3	The UIDL command of the POP3 protocol needs to be supported. You can access the mail server but cannot receive e-mails in the following circumstances. For details on the mail server, ask your network administrator. <ul style="list-style-type: none">• The UIDL command is not supported• The response to the UIDL command is negative ("-ERR")
	Select the [POP3 RX] check box.*
SMTP	Set the IP address of the printer. <ul style="list-style-type: none">➤ "Setting the IP Address (IP v. 4)"
	Select the [SMTP RX] check box.*

* For other settings and the setting procedures, see ["How to Specify the Settings for E-mail Print"](#) and specify them as needed.

➤ Printing a Fax Document Transferred from a Multi-function Machine

You can print a fax document transferred from a Canon multi-function machine.

➤ How to Specify the Settings for E-mail Print

You can set e-mail print settings from the printer control panel, Remote UI or FTP client.

➤ Receiving and Printing E-mails Manually

You can receive and print e-mails manually. There are two types of manual printing methods: printing from the printer control panel and printing from the Remote UI.

➤ Printing the E-mail Receive Log List

You can print the e-mail sending/receiving history. You can print the subject and sender in sending/receiving history. There are two ways of printing e-mail sending/receiving history: from the printer control panel and from the Remote UI.

➤ When E-mail Print Fails

If for some reason an email does not print normally, an error message is displayed on the printer display or Remote UI and network status print, or an error code is displayed in the e-mail sending/receiving history. Take action according to the displayed error messages and error codes.

IMPORTANT

Restrictions for E-mail Print

- Attached files are printable only when they are in TIFF or JPEG format.
- The number of attached files has to be 3 or less for each mail. If the number exceeds 3, the first 3 files are printed. However, the files of the 4th or later are not printed.

- The body of an HTML e-mail is printed as a plain text message.
- E-mail text is printed with its mail header information.
- If the number of characters in one text line (without a line break) in an e-mail exceeds 998, an automatic linefeed is performed. Because of this, the text in the next line may not be printed properly.
- When the toner cartridge is nearing the end of its lifetime, reception of e-mails becomes impossible.

Restrictions for E-mail Print (Only when the optional SD card is installed)

- If text data of an e-mail exceeds 25 MB, the text is not printed.
- If header data of an e-mail exceeds 20 KB, the excess part of 20 KB or more header data is not printed.
- Attached files are printable only when the size of each file is 100 MB or less. Attached files of more than 100 MB are not printed.
- If the size of an e-mail exceeds 1.5 GB, the e-mail text is not printed.
- Emails cannot be printed if there is no free space on the SD card.

JPEG data is in compliance with the specifications of ITU-T recommendation T.81.

On e-mail print with this printer, JPEG data is in compliance with the specifications of ITU-T recommendation T.81. TIFF data is in compliance with the specifications of Adobe TIFF Revision 6.0 and IETF RFC2301 (File Format for Internet FAX).

Internet FAX Simple Mode is supported.

The e-mail print function of this printer supports Internet FAX Simple Mode.

About the supporting status of encoding methods for JPEG data

For this printer, the supporting status is as follows.

- Supported encoding method
 - DCT baseline
- Unsupported encoding methods
 - DCT extension
 - Reversible compression
 - Hierarchical

About the supporting status of encoding methods for TIFF data

For this printer, the supporting status is as follows.

- Supported encoding methods
 - Uncompressed
 - ITU-T recommendation T.4 One-dimensional coding
 - ITU-T recommendation T.4 Two-dimensional coding
 - ITU-T recommendation T.6 Basic facsimile coding
 - ITU-T recommendation T.81 JPEG (Basic DCT only)
 - PackBits (Apple Macintosh PackBits)
 - LZW
- Unsupported encoding methods
 - ITU-T recommendation T.82 JBIG
 - ITU-T recommendation T.43 JBIG
 - ITU-T recommendation T.44 MRC

About the supporting status for encoding types

For this printer, the supporting status is as follows.

- 7bit
- 8bit
- binary
- quoted-printable
- base64
- uuencode
- x-uuencode

About the supporting status for character sets

For this printer, the supporting status is as follows. (If no character sets are specified, the data is processed with "us-ascii.")

- us-ascii
-

- iso-8859-1
 - iso-8859-15
-

Printing a Fax Document Transferred from a Multi-function Machine

04L9-0SE

Setting up the printer as an SMTP server allows you to print a fax document transferred from a Canon multi-function machine.

To use this function, the necessary settings and operations must be performed on the multi-function machine for transfer of documents to this printer using an Internet Fax (I-Fax) address.

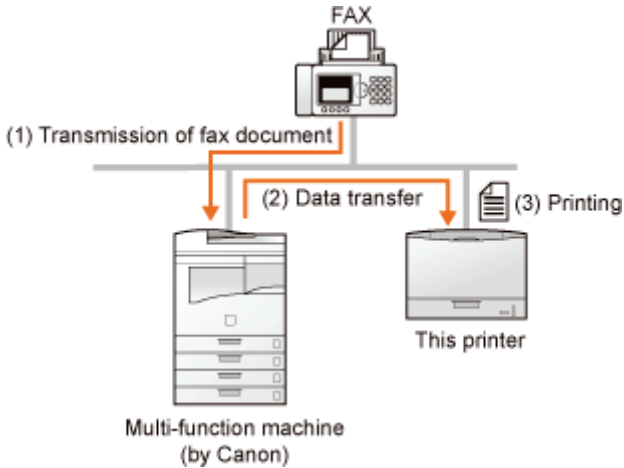

Usable protocol	Requirements
SMTP	Set the IP address of the printer. ❖ "Setting the IP Address (IP v. 4)"
	Select the [SMTP RX] check box. ❖ "How to Specify the Settings for E-mail Print"

IMPORTANT

Restrictions for the Internet Fax

- Attached files are printable only when they are in TIFF format.
- Only one attached file can be handled at a time.
When multiple files are attached, only the first attached file is printed. The second and following files will not be printed.
- When the toner cartridge is nearing the end of lifetime, reception of fax documents becomes impossible. If the toner cartridge is nearing the end of lifetime when the printer is receiving or printing a fax document, the printer stops printing.
Fax documents that this printer cannot receive will be printed on the Canon multi-function machine as the document transfer source.

Restrictions for the Internet Fax (only when the optional SD card is installed)

- The maximum printable size of attached file is 100 MB per file. Files of greater than 100 MB in size will not be printed.

How to Specify the Settings for E-mail Print

04L9-06W

Before performing the setup, see "Attention (How to Specify the Settings for E-mail Print)."

This section describes the procedures for registering or changing the settings using a Web browser (Remote UI).

1

Start the Remote UI, and then log in as Administrator.

➤ "Starting the Remote UI"

2

Click [Network] under [Preferences] in the [Settings/Registration] menu.

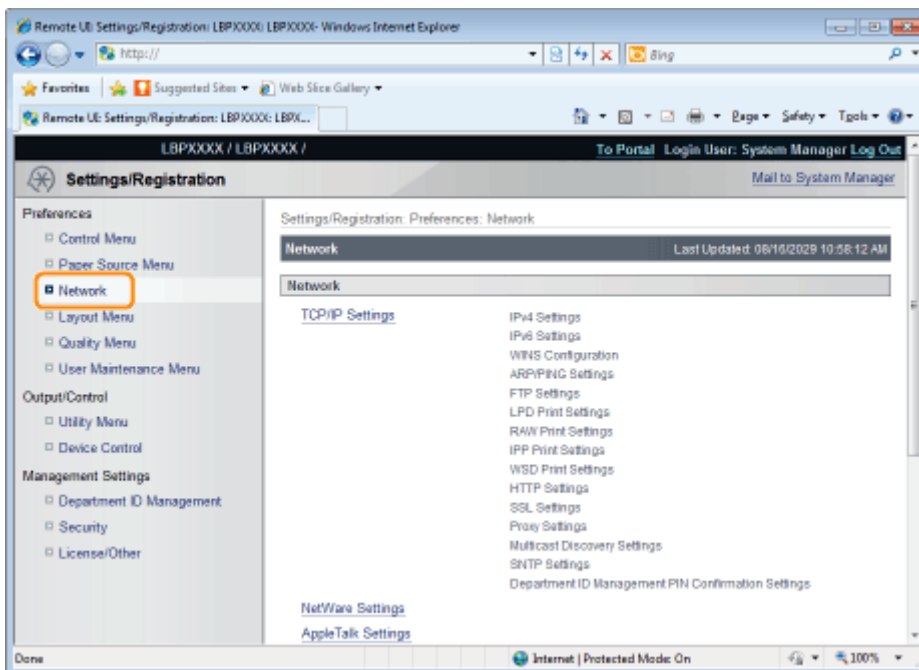

3

Click [E-Mail Print Settings].

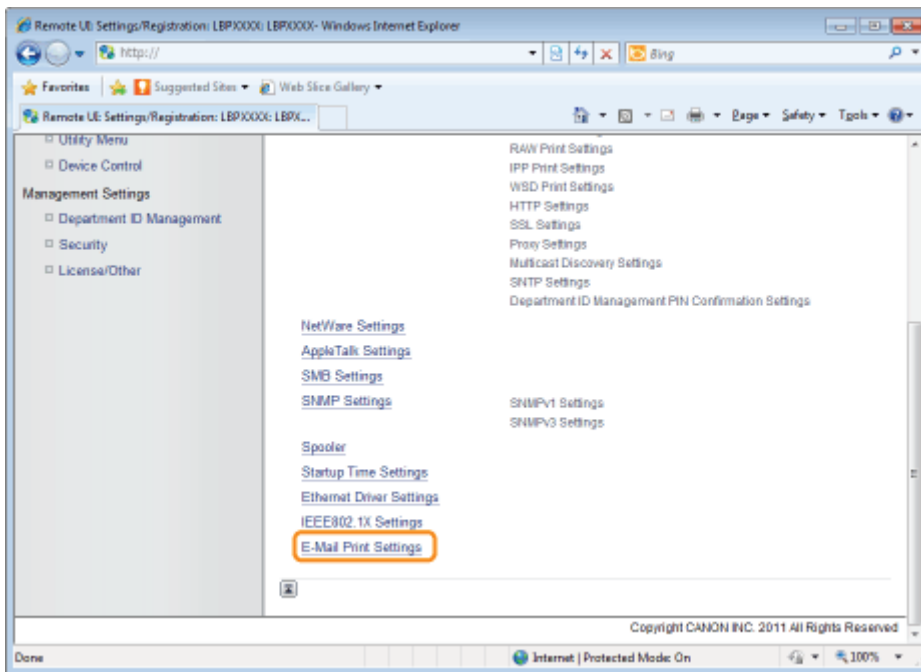

4

Click [Edit...] on the right side of [E-Mail Print Settings].

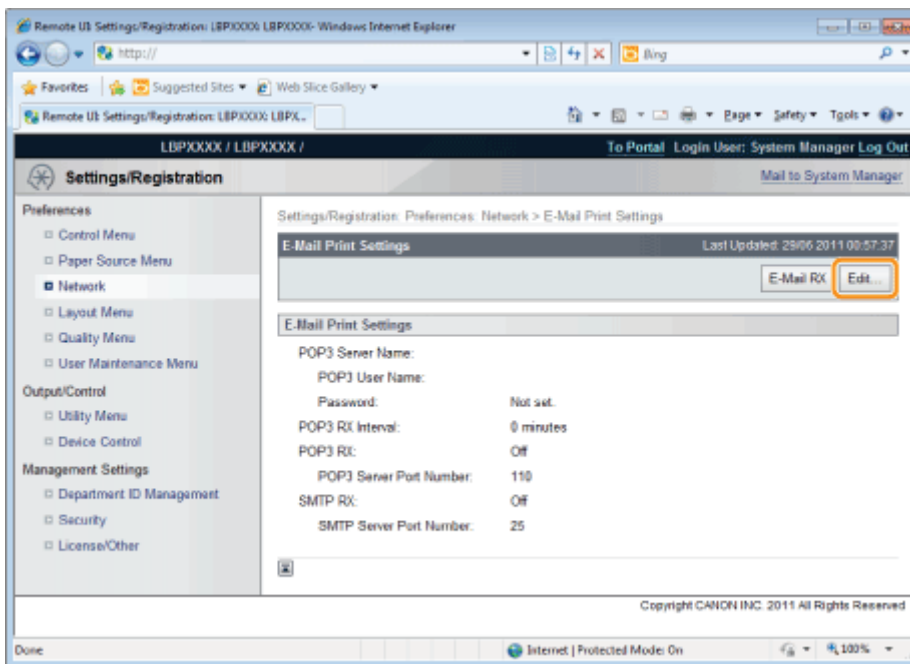

5

Specify the settings for the e-mail print function.

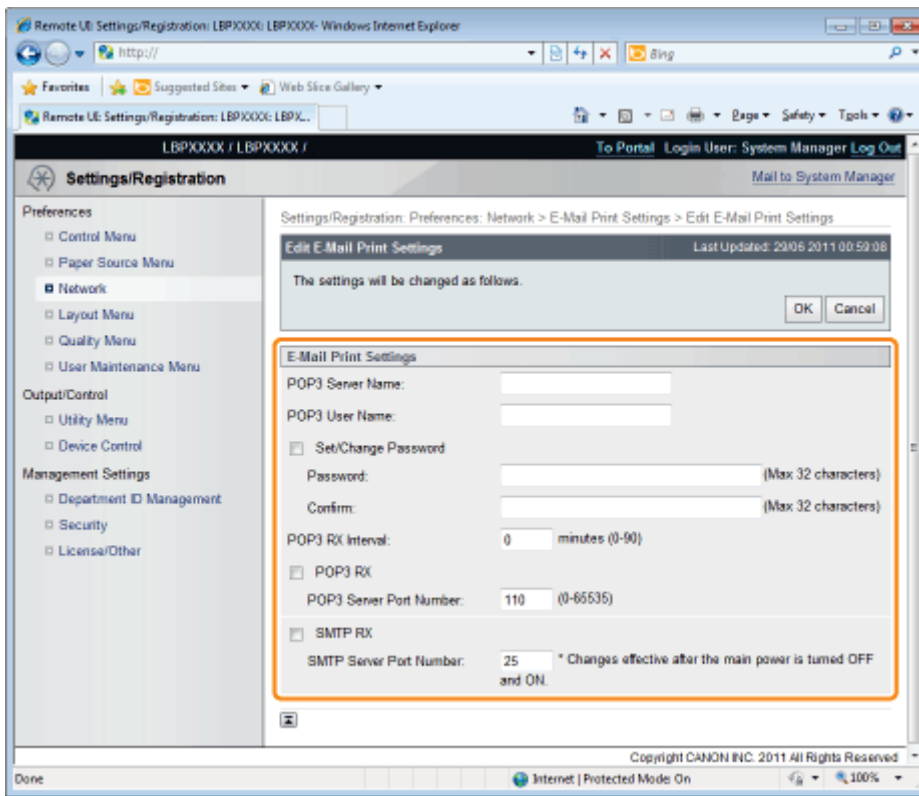

If you want to use the POP3 protocol

[POP3 Server Name]	Specifies the name or sets the IP address of the server which receives e-mails.
[POP3 User Name]	Specifies the name of the user which receives e-mails. You can enter up to 32 alphanumeric characters.
[Set/Change Password]	Specifies the password for the name of the user which receives e-mails.
[Password]	Select the check box when setting/changing the password. You can enter up to 32 alphanumeric characters.
[Confirm]	For confirmation, enter the same [Password] again.
[POP3 RX Interval]	Set the interval for automatically connecting to the server that receives e-mail in minute units. Receive e-mail at specified intervals and print it automatically. You can set from [0] (minutes) to [90] (minutes). When it is set to [0], it does not automatically receive e-mail from the server. When it is set to [0] and when you want to connect to the server before it automatically connects to the server that receives e-mail, you can receive e-mail manually. "Receiving and Printing E-mails Manually"
[POP3 RX]	Specifies whether to enable the e-mail print function.
[POP3 Server Port Number]	Specifies the port number for the server which receives e-mails. You can specify the port number between [0] and [65535].

If you want to use the SMTP protocol

[SMTP RX]	When it is checked, e-mail is relayed using SMTP protocol and it is automatically received and printed.
[SMTP Server Port Number]	Specifies the port number for the server which receives e-mails. You can specify the port number between [0] and [65535].

Click [OK].

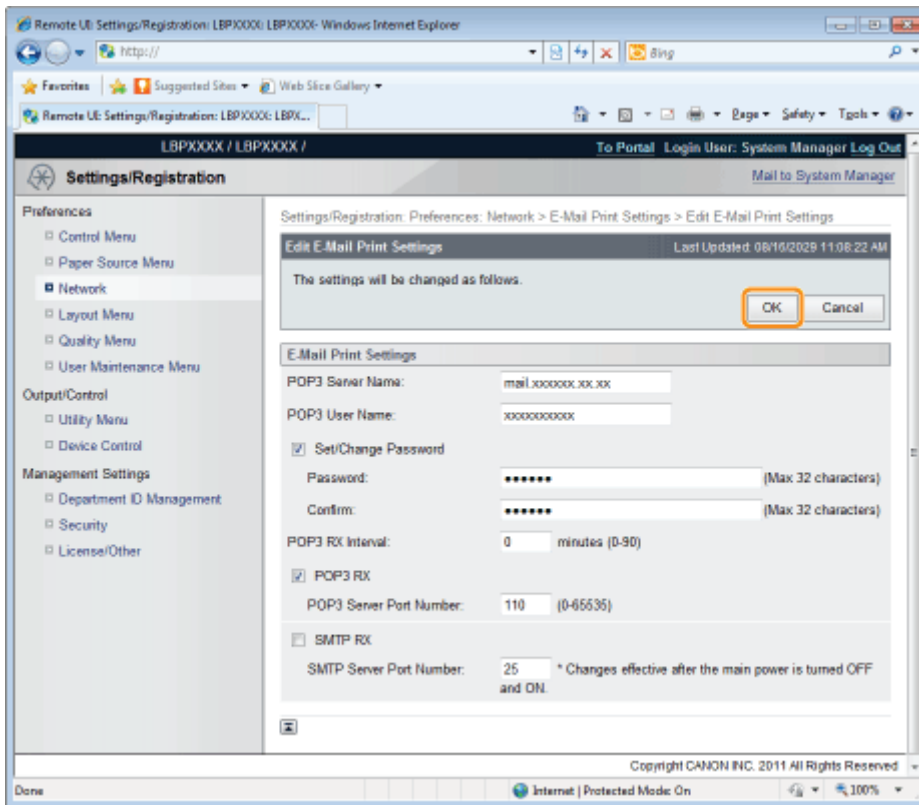

Attention (How to Specify the Settings for E-mail Print)

04L9-06X

The following are settings for printing e-mails.

You can set them from the printer control panel, Remote UI or FTP client.

○ : Can be specified — : Cannot be specified

Settings for Using the POP3 Protocol

Option	Setting	Setting Method		
		Control Panel	Remote UI	FTP Client
POP3 Server Name	Specifies the name or sets the IP address of the server which receives e-mails.	—	○	○
POP3 User Name	Specifies the name of the user which receives e-mails.	—	○	○
Password	Specifies the password for the name of the user which receives e-mails.	—	○	○
POP3 RX Interval	Set the interval for automatically connecting to the server that receives e-mails in minute units. Receive e-mail at specified intervals and print it automatically.	○	○	○
POP3 RX	Specifies whether to enable the e-mail print function.	○	○	○
POP3 Server Port Number	Specifies the port number for the server which receives e-mails.	—	○	○
E-Mail RX	Performs manual receiving of e-mails.	○	○	—

Settings for Using the SMTP Protocol

Option	Setting	Setting Method		
		Control Panel	Remote UI	FTP Client
SMTP RX	Select whether to enable the e-mail printing function. When it is enabled, e-mail is automatically received and printed.	○	○	—
SMTP Server Port Number	Specifies the port number for the server which receives e-mails.	—	○	—

Other Settings

Option	Setting	Setting Method		
		Control Panel	Remote UI	FTP Client
Print History List (E-Mail Print)	Prints e-mail print logs.	○	○	—
Show Warnings	Specifies whether a message should appear or any indicator should blink when a reception error has occurred on printing e-mails.	○	○	—
Print E-Mail Text	Specifies whether the printer should print the text on printing e-mails.	○	—	—
	Specifies whether to limit the number of the print pages of e-	○	—	—

Receiving and Printing E-mails Manually

04L9-06Y

IMPORTANT

Receiving E-mails

The printer can receive e-mails only when it is online.

When using POP3 protocol

When it is set to receive e-mail automatically using [POP3 RX Interval], if you attempt to receive e-mail manually while e-mail is being received automatically, your actions will be ignored.

➤ ["How to Specify the Settings for E-mail Print"](#)

When using SMTP protocol



It automatically receives and prints e-mails. There is no need to manually receive and print them.

➤ ["How to Specify the Settings for E-mail Print"](#)

Printing from the Printer Control Panel

1

Make sure that the printer is online.

If the printer is not online, press [] ( : Online).

2

Press [] ( /  : Utility) to display the Utility menu.

3

Press [] and [], select [E-Mail Print Utility], and then press [OK].

4

Press [] and [], select [Received E-Mails], and then press [OK].

5

When <Run?> is displayed, press [], select [Yes], and then press [OK].

The printer is connected to the mail server. The printer receives e-mails addressed to the printer and print them.

Printing from a Remote UI

1

Start the Remote UI.

➤ "Starting the Remote UI"

2

Click **[Network]** under **[Preferences]** in the **[Settings/Registration]** menu.

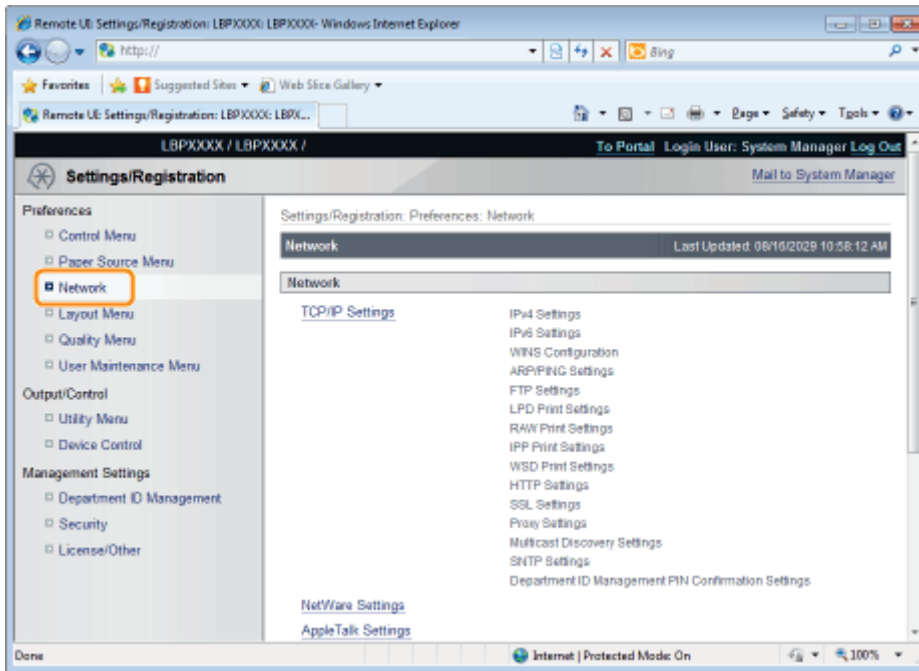

3

Click **[E-Mail Print Settings]**.

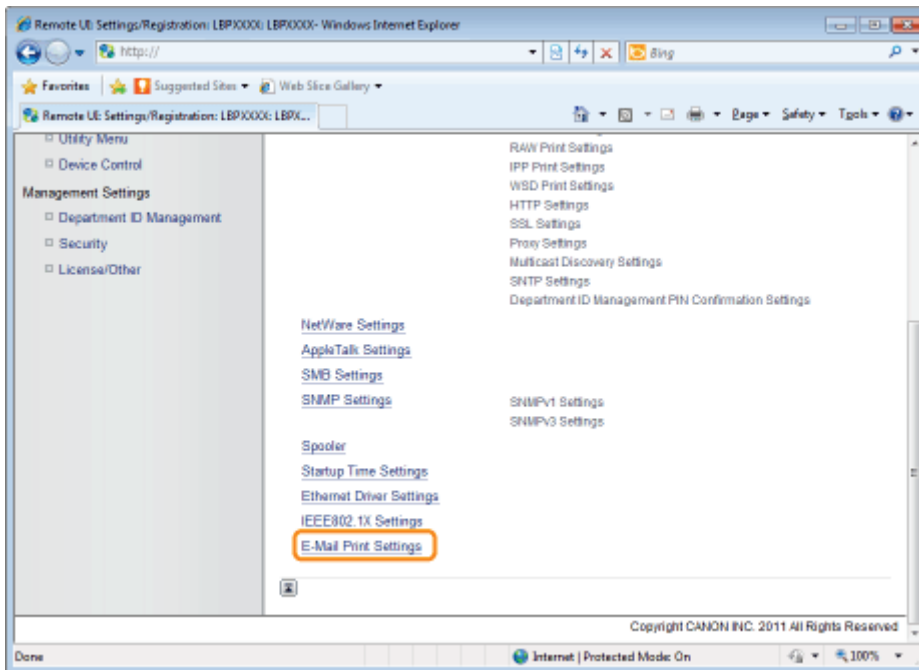

4

Click **[E-Mail RX]** on the right side of **[E-Mail Print Settings]**.

The printer is connected to the mail server. The printer receives e-mails addressed to the printer and print them.

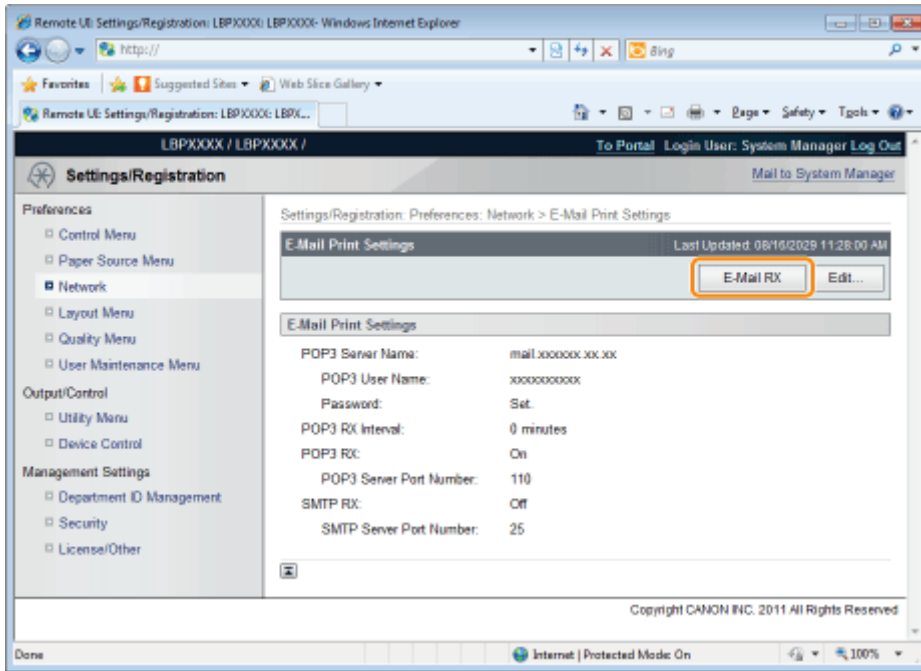

Printing the E-mail Receive Log List



04L9-070

Before beginning to print, see "Attention (Printing E-mail Sending/Receiving History)."

Printing from the Printer Control Panel

1

Make sure that the printer is online.

If the printer is not online, press [] ( : Online).

2

Press [] ( /  : Utility) to display the Utility menu.

3

Press [] and [], select [E-Mail Print Utility], and then press [OK].

4

Press [] and [], select [Received E-mail List], and then press [OK].

5

When <Run?> is displayed, press [], select [Yes], and then press [OK].

The e-mail receive log list is printed.

Printing from a Remote UI

1

Start the Remote UI, and then log in as Administrator.

➤ "Starting the Remote UI"

2

Click [Utility Menu] under [Output/Control] in the [Settings/Registration] menu.

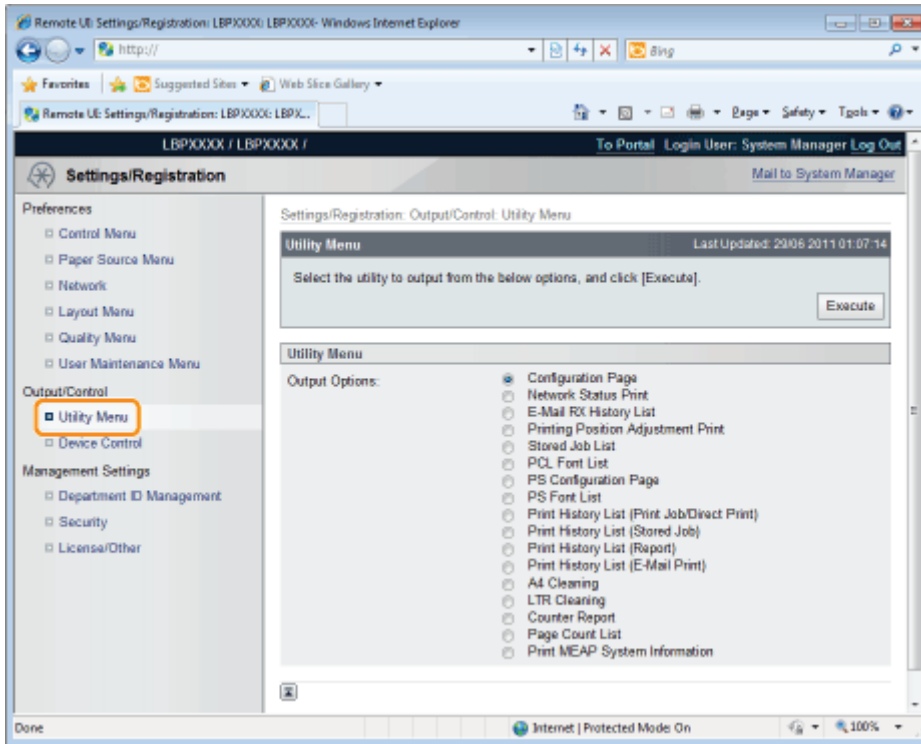

3

Select [E-Mail RX History List], and then click [Execute].

The e-mail receive log list is printed.

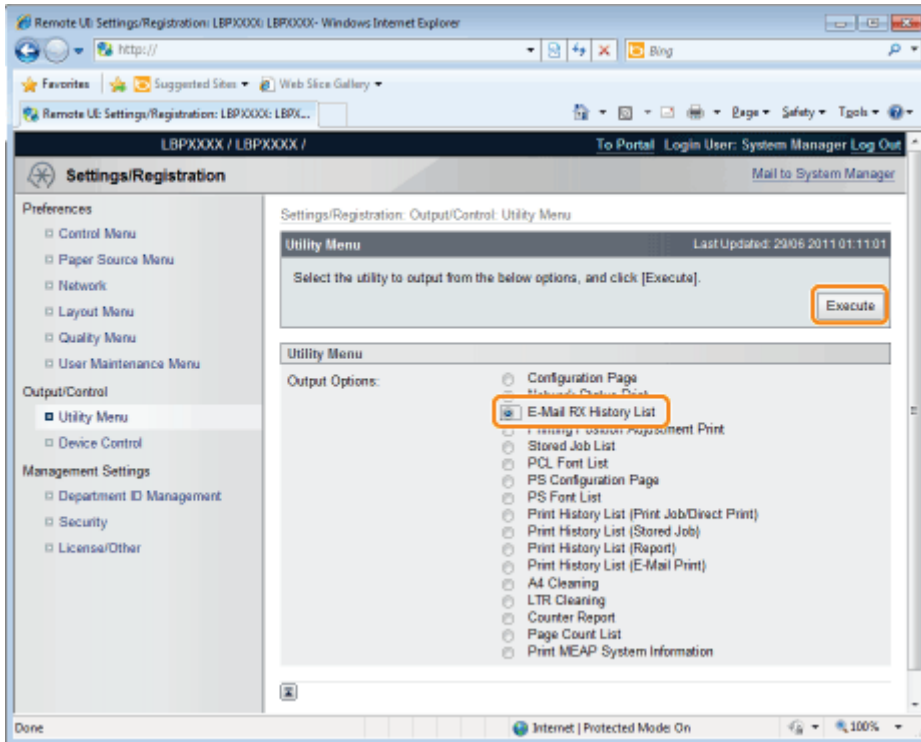

Attention (Printing E-mail Sending/Receiving History)

04L9-071

IMPORTANT

Deleting all the e-mail receive logs

Delete them using the following procedure.

- When the optional SD card is installed
Formatting the SD card in [SD Card Maintenance]
❖ "[Setup] Menu ([User Maintenance] Options)"
- When the optional SD card is not installed
Turn the printer OFF.
❖ "Turning the Printer ON/OFF"

NOTE

About the e-mail receive log

Up to 60 e-mail receive logs can be printed.

If an e-mail is not printed properly for some reason

An error code is printed in [RX Results] in the e-mail receive log. See "[When E-mail Print Fails.](#)"

When E-mail Print Fails

04L9-072

Perform the following actions depending on the displayed error messages and error codes.

Error messages and error codes are displayed in the following locations.

- Printer Display
- Remote UI ([Error Information] page in the [Status Monitor/Cancel] menu)
- Network Status Print
- ["The Lists Common to All the Settings in the Print Mode"](#)
- E-Mail Sending/Receiving History

See ["Printing the E-mail Receive Log List"](#) for printing methods.

The error messages that appear in the display, Remote UI, and Network Status Print

Error Message		Cause	Remedy
Display	Remote UI, Network Status Print		
EM POP3 server error.	POP3 Server Connection Error	Could not connect to the POP3 server when printing e-mails.	Check the following points. <ul style="list-style-type: none"> • Whether the following settings in the [Network] page in the Remote UI are correct <ul style="list-style-type: none"> – [POP3 Server Name] and [POP3 Server Port Number] in [E-Mail Print Settings] – DNS in [TCP/IP Settings] • Whether the POP3 server and the DNS server are operating properly
	POP3 Server User Name Error	Failed to authenticate the user name in the POP3 server when printing e-mails.	Check the following points. <ul style="list-style-type: none"> • Whether the setting for [POP3 User Name] in [E-Mail Print Settings] in the [Network] page in the Remote UI is correct • Whether the user name is registered in the POP3 server properly
	POP3 Server Password Error	Failed to authenticate the password in the POP3 server when printing e-mails.	Check the following points. <ul style="list-style-type: none"> • Whether the setting for [Password] in [E-Mail Print Settings] in the [Network] page in the Remote UI is correct • Whether the password is registered in the POP3 server properly
	POP3 Server UIDL Error	Could not connect to the POP3 server when printing e-mails, because the server does not support the UIDL command.	Use a POP3 server that supports UIDL.
EM E-Mail access error.	—	The printer could not connect to the POP3 server because an error had occurred in its hard disk.	Clear the hard disk error on the POP3 server.

The error codes that are displayed in the e-mail receive log list*

- If multiple errors have occurred, only the error of the highest priority is displayed (high: 407 > low: 499).

Error Code	Cause	Remedy
407	The connection to the POP server was disconnected.	<ul style="list-style-type: none"> Consult your network administrator. If errors occur many times on the same e-mail data, check if the e-mail data is normal.
	Could not receive data of 1 Kbyte (1024 byte) for 10 minutes while receiving e-mails.	
408	The response <ERR> was returned from the POP server.	Consult your network administrator.
412	Could not receive data of 1 Kbyte (1024 byte) for 10 minutes while receiving e-mails.	<ul style="list-style-type: none"> Consult your network administrator. If errors occur many times on the same e-mail data, check if the e-mail data is normal.
420	The size of the e-mail data exceeded 1.5 GB.	Reduce the size of the e-mail data to 1.5 GB or less.
421	The size of the e-mail text exceeded 25 MB.	Reduce the amount of the e-mail text.
422	The size of the attached files exceeded 100 MB.	Reduce the size of the attached files to 100 MB or less.
423	An attached file in an unsupported format was sent.	Change the format of the attached file into TIFF or JPEG.
424	The number of the attached files exceeded 3.	Reduce the number of the attached files to 3 or less.
430	An e-mail in which [From] is blank was sent.	Enter a name in [From].
431	Received a divided mail.	<p>Apply the following remedies to send the e-mail so that it is not divided.</p> <ul style="list-style-type: none"> Reducing the size of the e-mail to be sent (Reducing it to the size which cannot be divided). Specifying the application settings so that the e-mail is sent without being divided.
	An e-mail which included unsupported encoding or character encoding was sent.	<p>Change the encoding or character encoding into that supported by this printer.</p> <ul style="list-style-type: none"> "Receiving E-mail Data on the Mail Server and Printing (E-mail Print)"
	Received a mail of an unsupported type (message type).	<p>Change the content type into any one of the following types that are supported by this printer.</p> <ul style="list-style-type: none"> text/plain image/jpeg image/tiff image/tiff-fx application/octet-stream
	Received an unsupported multipart mail.	<p>Change the content type of the multipart mail into any one of the following types that are supported by this printer.</p> <ul style="list-style-type: none"> multipart/mixed multipart/parallel multipart/alternative <p>If the mail is nested, the mail is supported only when "multipart/alternative" is nested in "multipart/mixed."</p>
432	Invalid data was sent.	Check if the sent e-mail data is normal.
433	An e-mail in HTML format was sent.	This printer does not support e-mails in HTML format.

434	The e-mail does not contain a text.	Enter the text.
440	The job was canceled for some reason.	Send the e-mail again.
441	An error has occurred during the process.	Send the e-mail again.
499	An error has occurred in the printer.	❏ See "A Message Appears in the Control Panel."

Printing Files from the Printer Using FTP Client

04L9-073

You can print files from the printer by accessing the FTP server of the printer using FTP Client.

IMPORTANT

When performing FTP printing, select the [Use FTP Print] check box.

- ["Configuring the Protocol Settings"](#)

1

Run Command Prompt.

NOTE

If you are using Windows

Run Command Prompt using the following procedure.

- From the [Start] menu, select [All Programs] or [Programs] → [Accessories] → [Command Prompt].

If you are using UNIX

Display the console screen.

2

Copy the file to be printed in the directory displayed in Command Prompt.

3

Enter "ftp <the IP address of the printer>" in Command Prompt, and then press the [ENTER] key on your keyboard.

- Input Example: "ftp 192.168.0.215"

If you are not sure about the IP address of the printer

Consult your network administrator.

4

Enter the FTP print user name, and then press the [ENTER] key on your keyboard.

† The default user name is "guest".

† You cannot perform an anonymous login.

5

Enter the FTP print password, and then press the [ENTER] key on your keyboard.

† The default password is "7654321".

6

Enter **"put <the name of the file to be printed>"**, and then press **[ENTER]** on your keyboard.

- Input Example: "put sample.txt"
- The file is printed from the printer.

IMPORTANT

When printing a file

Print the file in the binary mode.

7

Enter **"quit"**, and then press the **[ENTER]** key on your keyboard.

8

Enter **"exit"**, and then press the **[ENTER]** key on your keyboard.

- Command Prompt closes.

Specifying a Password for a Document and Printing (Secured Print) (LBP6680x Only)

04L9-074

In a secured print or encrypted secured print, a print job for which a password is specified is saved in the SD card of the printer, and the job is printed by entering the password using the printer's control panel. This function is convenient when you print a confidential document etc. that you do not want others to read.

Before beginning to print, see "Attention (Specifying a Password for a Document and Printing (Secured Print))."

† It is used only when the optional SD card is installed.

1

Print a secured print job or encrypted secured print job using the printer driver.

NOTE

How to print a secured print job

Print a secured print job by selecting [Secured Print] in the printer driver, and then entering the user name and password.

The number of characters which can be specified for a secured print job

Specify the user name for a secured print with 15 or less alphanumeric characters and the password with 1 to 7 characters.

For details on the encrypted secured print

For details on the restriction for the number of characters of an encrypted secured print password and how to print the job, see Help of "Encrypted Secured Print Driver Add-in."



You can display Help from the print driver after installing "Encrypted Secured Print Driver Add-in."

2

Move to the printer when printing.

3

Make sure that the printer is online.

If the printer is not online, press [] ( : Online).

4

Press [] ( : Job).

5

Select [Secured Print] or [Encrypted Print] using [▲] and [▼], and then press [OK].

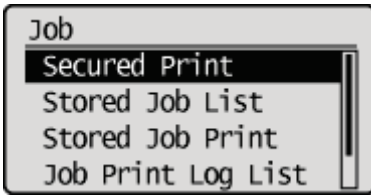

6

If the user names appear, select the target user name using [▲] and [▼], and then press [OK].

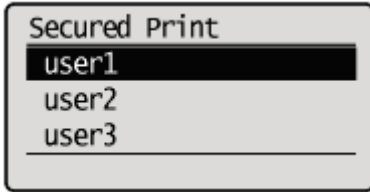

7

If the file names appear, select the target file name using [▲] and [▼], and then press [OK].

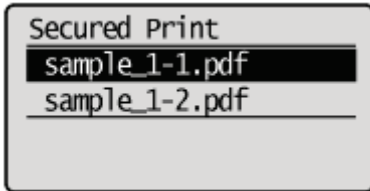

8

Enter [PIN], and then press [OK].

Increase or decrease a number using [▲] and [▼], and then move the cursor using [◀] and [▶].

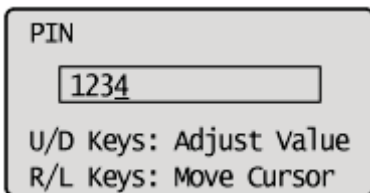

→ The specified file is printed.

NOTE

Entering a password using the control panel

Only numbers can be entered.

If a password includes alphabetical characters or symbols

Alphabetical characters or symbols can be specified for a password depending on the encrypted secured print driver version. In this case, print an encrypted secured print job from the Remote UI.

For details on the procedure for operating the Remote UI, see "[Remote UI](#)."

Attention (Specifying a Password for a Document and Printing (Secured Print))

04L9-075



NOTE

The environment in which this function is unavailable

You cannot use this function on the DOS application, UNIX or other computer on which the printer driver cannot be used. Print jobs are processed in the [Print] mode.

When the amount of data or number of jobs that you can save on the SD card exceeds the limit

The message <Cannot perform secured print.> appears. When the message is displayed, perform the following procedure.

- (1) Press [] ( : Online) to skip the error. (The job for which the error was skipped will be deleted.)
- (2) Delete any unnecessary jobs from among the jobs saved on the SD card.
- (3) Save the secured print jobs again.

When using the "Encrypted Secured Print" function whose security is reinforced for data communication and stored data

You need to install "Encrypted Secured Print Driver Add-in."

For details on the installation procedure, see "Readme.txt" in the supplied CD-ROM.

† We recommend that an encrypted secured print be used when printing secured print jobs.

Timing to delete secured print jobs

Secured print jobs/encrypted secured print jobs are deleted in the following circumstances:

- When the printer is turned OFF
- When a hard reset or soft reset is performed
- After a secured print job/encrypted secured print job is printed
- When no printing operation has been performed by the printer's control panel or Remote UI for a fixed period
- The time interval from when no printing operation is not performed by the Remote UI or printer's control panel for a fixed period until the printer deletes jobs is set to "1 hour" in the default settings. You can change the setting for the time interval.

➤ "[Setup] Menu ([Control Menu] Options)"

Saving a Document in the SD Card in the Printer (Stored Job Print) (LBP6680x Only)

04L9-076

You can save print jobs in the SD card (box) in the printer by selecting [Store] from the printer driver for this printer. In addition, stored jobs can perform the following operations from the printer's control panel and the Remote UI.

▸ Performing a Stored Job Print Using the Control Panel of the Printer

You can print data by selecting the saved box or job.

▸ Displaying or Operating the Jobs Stored in a Box (Resume/Delete)

You can check or operate the jobs stored in a box. You can perform operations of Resume (Print) and Delete. You can also check the jobs in detail. This operation is performed from the Remote UI.

▸ Changing the Box Settings

You can change the name of the box in which data is saved or password. This operation is performed from the Remote UI.



📌 NOTE

About stored jobs

- The stored jobs can be displayed or operated only when the SD card is installed, and [SD Card] is set to [On]. For details on the settings for [SD Card], see "[Setup] Menu ([Control Menu] Options)."
- The saved jobs are saved on the SD card even after printing, and they are not deleted even after turning the printer OFF. When you want to delete the saved jobs, use the Remote UI.
- Up to the total of 100 jobs in all the boxes can be saved.
- You can change the name of the stored job in the printer driver before printing.

When the amount of data or number of jobs that you can save on the SD card exceeds the limit

The message <Cannot store.> is displayed. When the message is displayed, perform the following procedure.

- (1) Press [] ( : Online) to skip the error. (The job for which the error was skipped will be deleted.)
- (2) Delete any unnecessary jobs from among the jobs saved on the SD card.
- (3) Save the jobs again.

Operating the Remote UI

- "Remote UI"

Performing a Stored Job Print Using the Control Panel of the Printer

04L9-077

1



Select [Store] from [Output Method] in the printer driver, specify the box in which you want to store the job, and then send it.

2

Move to the printer when printing.

3

Make sure that the printer is online.

If the printer is not online, press [] ( : Online).

4

Press [] ( : Job).

5

Select [Stored Job Print] using [▲] and [▼], and then press [OK].

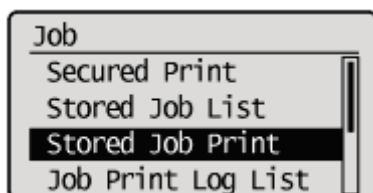

6

Select the number for the box in which the job is stored using [▲] and [▼], and then press [OK].

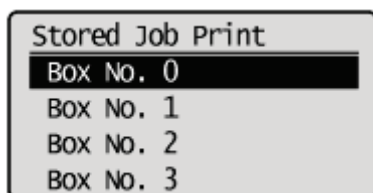

7

If [PIN] appears, enter the password, and then press [OK].

Increase or decrease a number using [▲] and [▼], and then move the cursor using [◀] and [▶].

PIN

1234

U/D Keys: Adjust Value
R/L Keys: Move Cursor

8

Select the name of the target file using [▲] and [▼], and then press [OK].

The specified file is printed.

Stored Job Print

sample_1.pdf

sample_2.pdf

Displaying or Operating the Jobs Stored in a Box (Resume/Delete)

04L9-078

1

Start the Remote UI, and then log in as Administrator.

➤ "Starting the Remote UI"

2

Select [Box] Menu.

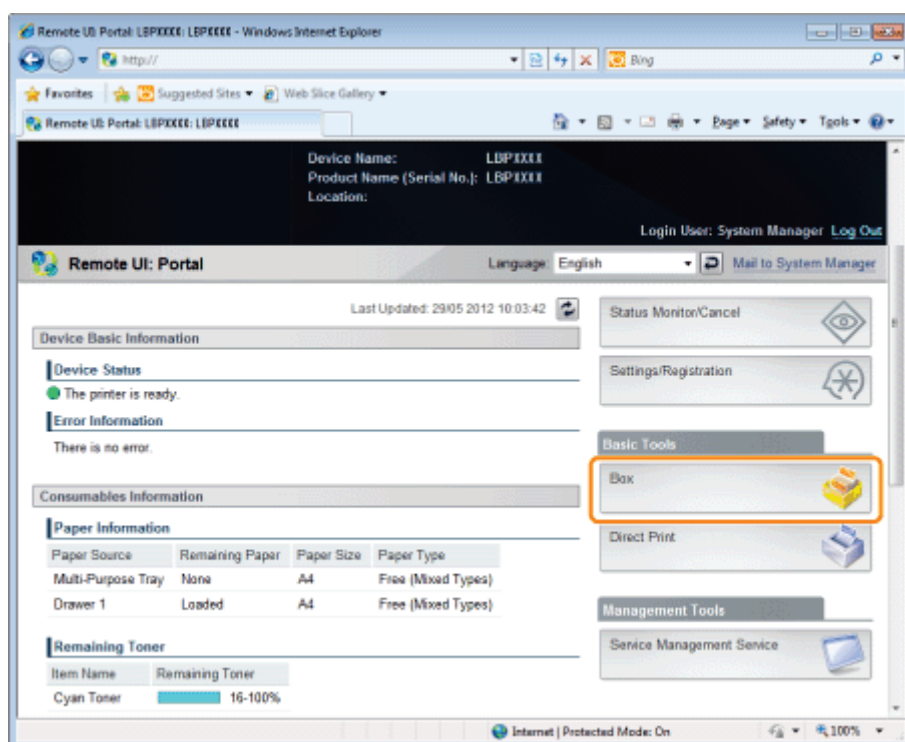

3

Enter the box number of the box where the job that you want to check or operate is stored, and then click [Open...].

You can also display the job list inside the box by clicking on the icon displayed on the Box Number.

† If a password is specified for the box, enter the password, and then click [OK].

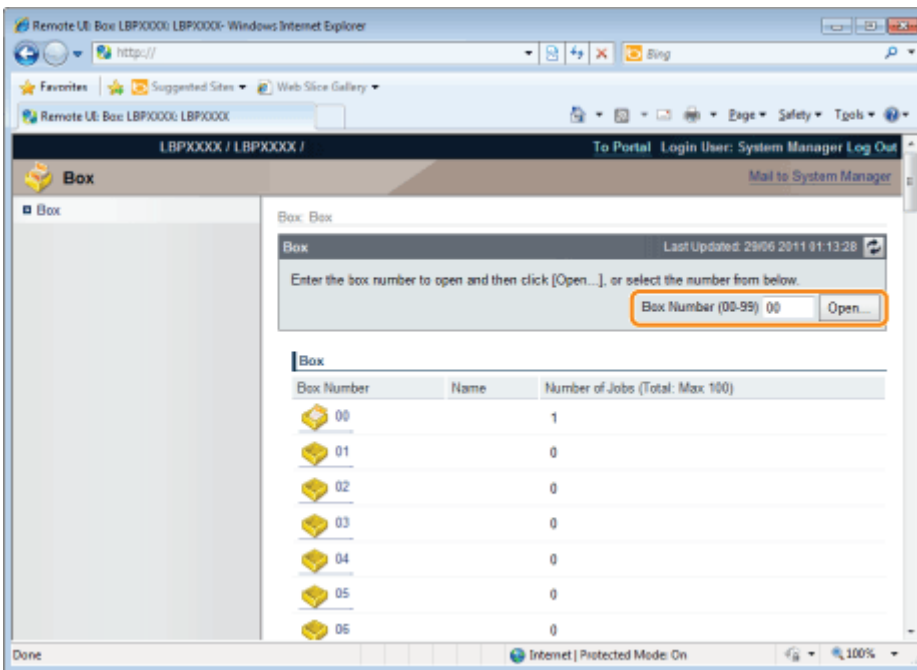

4

When you want to operate any stored job, perform the following procedure.

- (1) Select the [Select] check box by the first job on the list.
- (2) Click the operation buttons.

[Print...]: Prints the selected job.

[Delete]: Deletes the selected job.

You can display the page that allows you to change the print copies etc. by clicking [Print...].

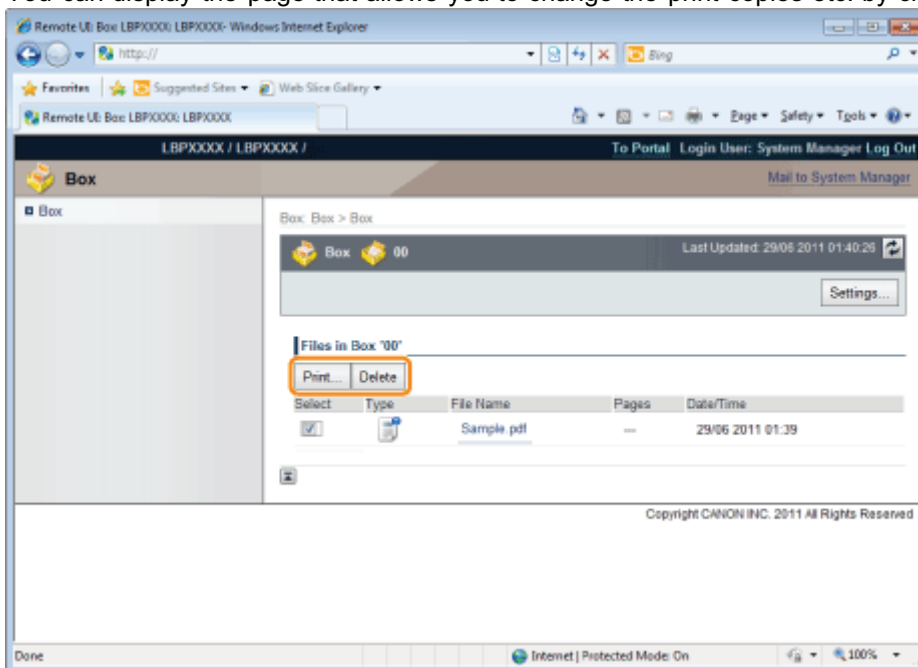

- (3) Change the settings, and then click [Start Printing].

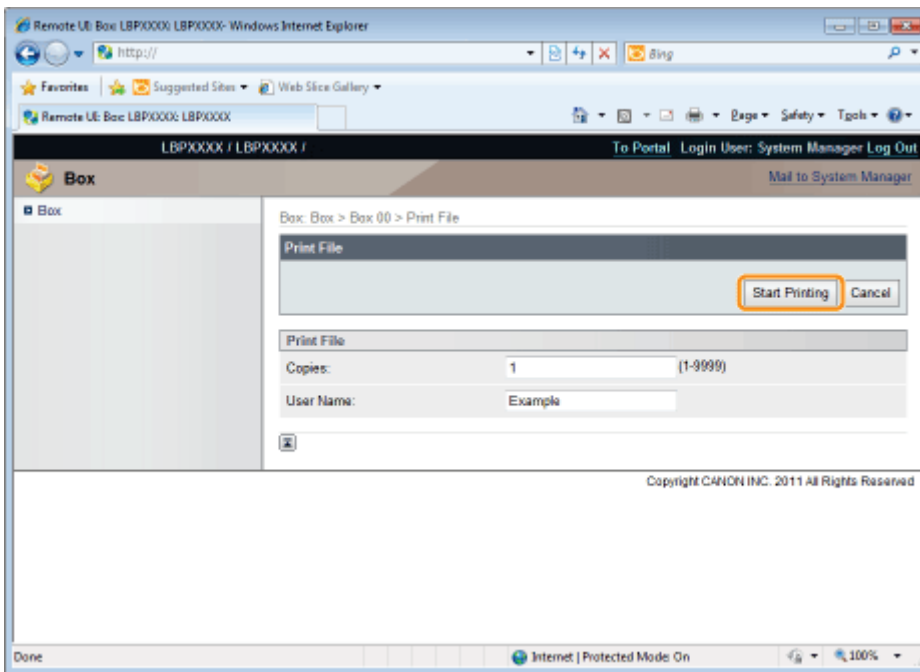

NOTE

Changing the number of the print copies

You cannot change the number of the print copies depending on the job. Also, changes to print runs of saved jobs that have [Prioritize Print Ticket] set in XPS format will be ignored.

Displaying a document name

A job file name of up to 32 characters can be displayed for a document name. If the file name has more than 32 characters, the characters after the limited number are not displayed. Also, depending on the application, the application name may be added to the beginning of the file name.

5

Click the document name to display details of the saved job.

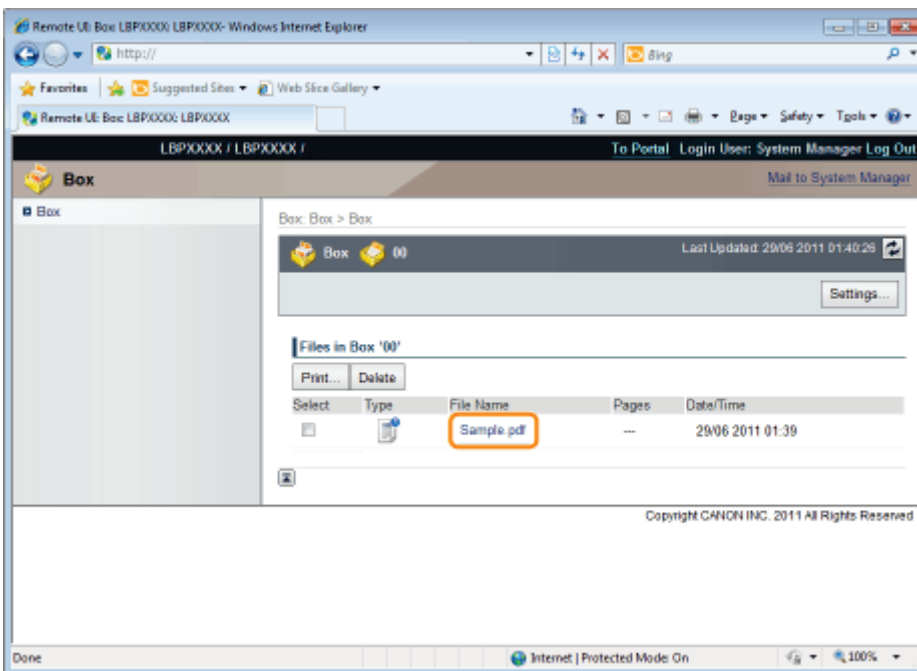

6

The detailed information of the stored jobs is displayed.

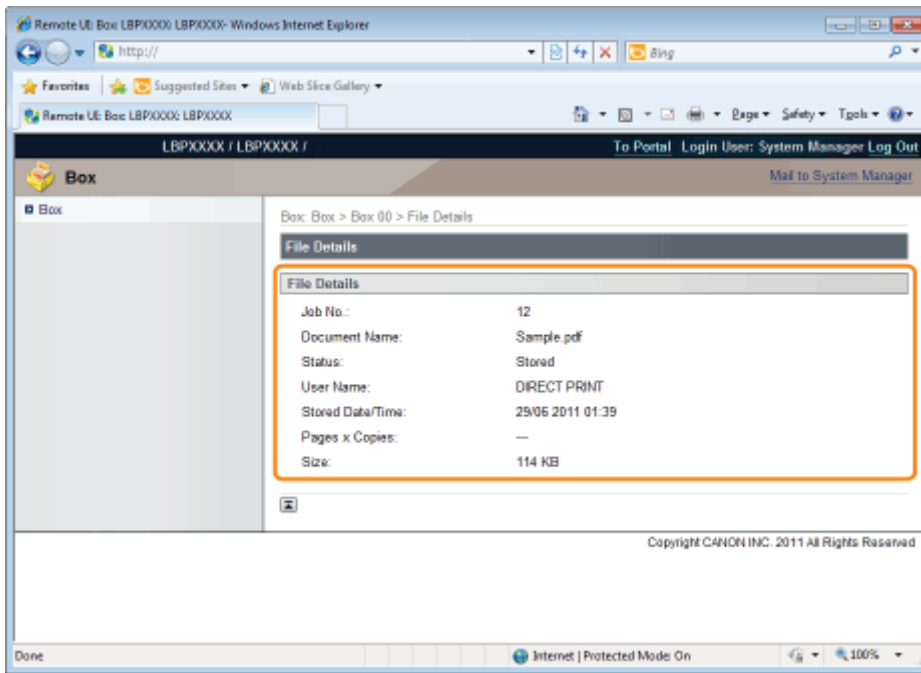

Automatically Deleting Files Stored in a Box

04L9-0S5

Stored jobs can be deleted automatically by setting a length of time to pass between storing of the jobs and their deletion. This setting is made using the Remote UI.

1

Start the Remote UI, and then log in as Administrator.

➤ "Starting the Remote UI"

2

Click [Settings/Registration].

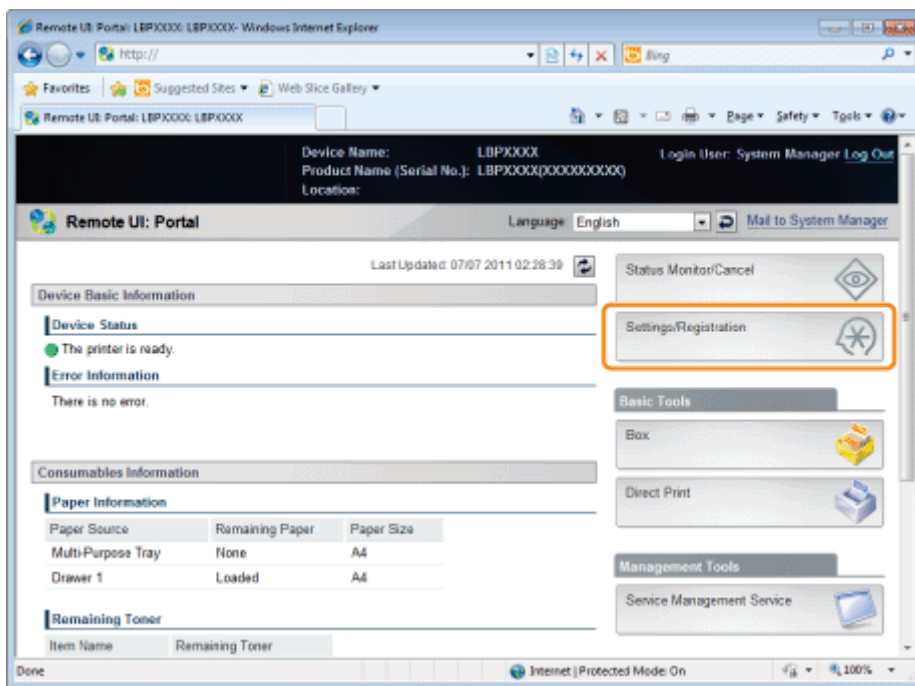

3

Select [Control Menu] from the [Preferences] menu.

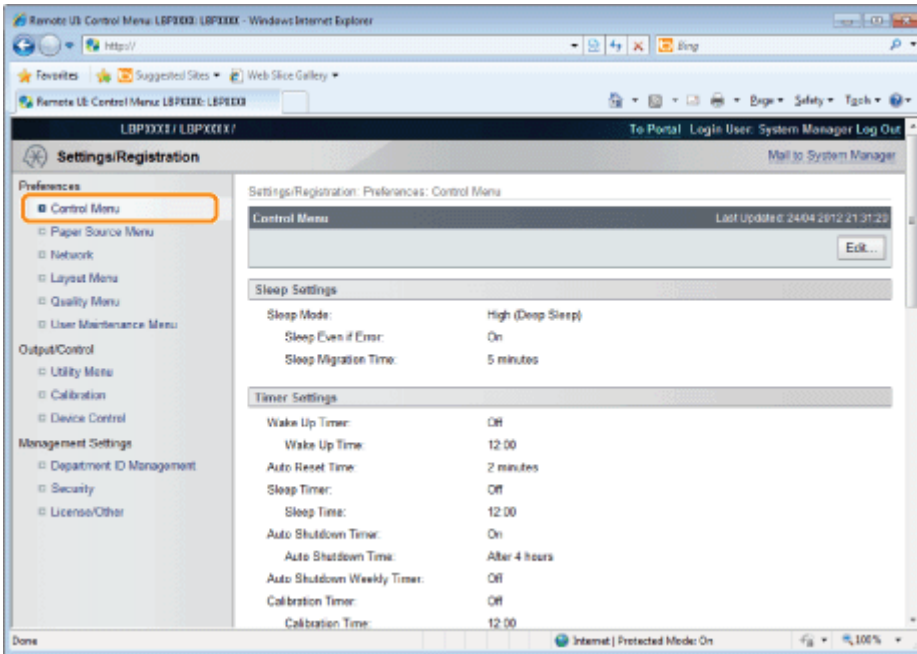

4

Click [Edit...].

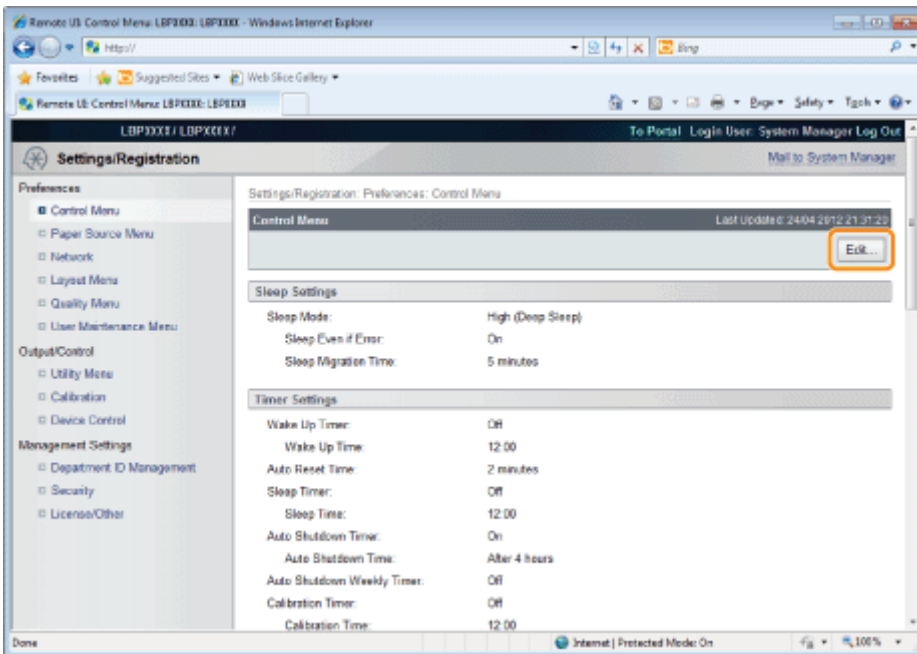

5

Set a length of time to pass before deletion of stored jobs.

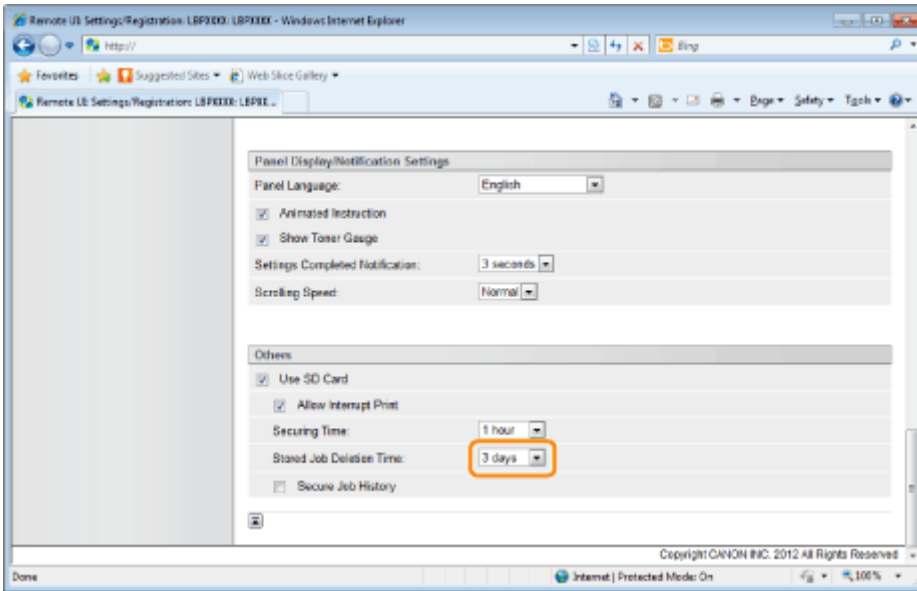

The default setting is [3 days].

↑ To not delete automatically, select [Off].

6

Click [OK].

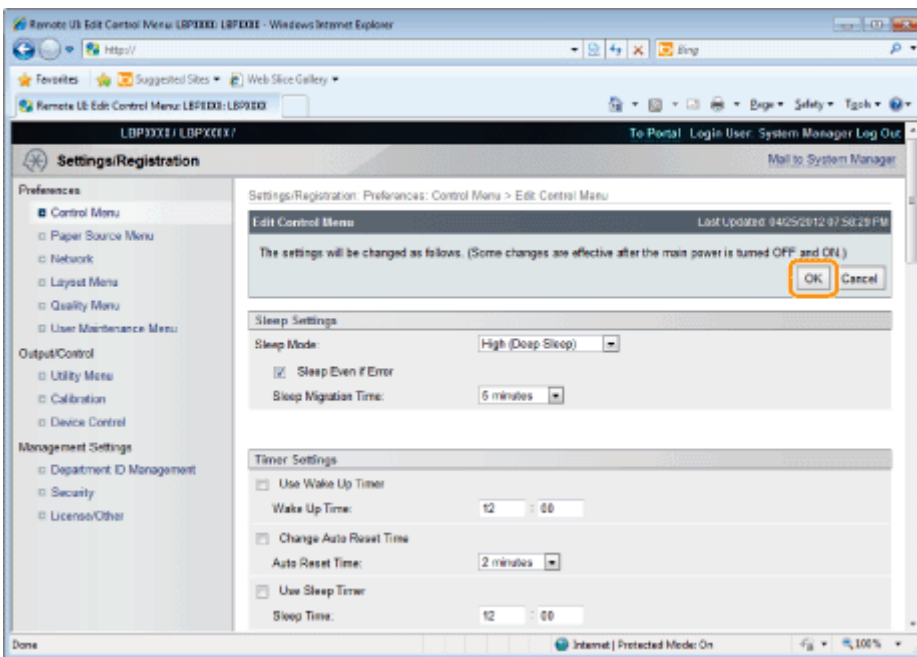

Changing the Box Settings

04L9-079

NOTE

You can change the settings only if you have logged on as Administrator.

➤ "Remote UI"

1

Start the Remote UI, and then log in as Administrator.

➤ "Starting the Remote UI"

2

Select the [Box] menu.

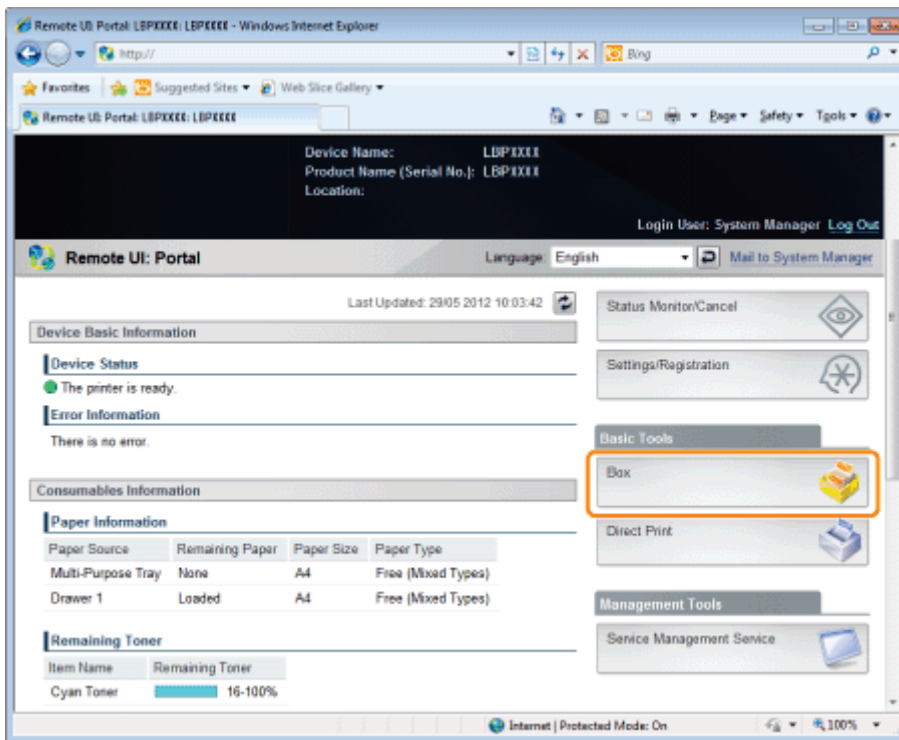

3

Enter the box number of the box where the job that you want to check or operate is stored, and then click [Open...].

You can also display the job list inside the box by clicking on the icon displayed on the Box Number.

† If a password is specified for the box, enter the password, and then click [OK].

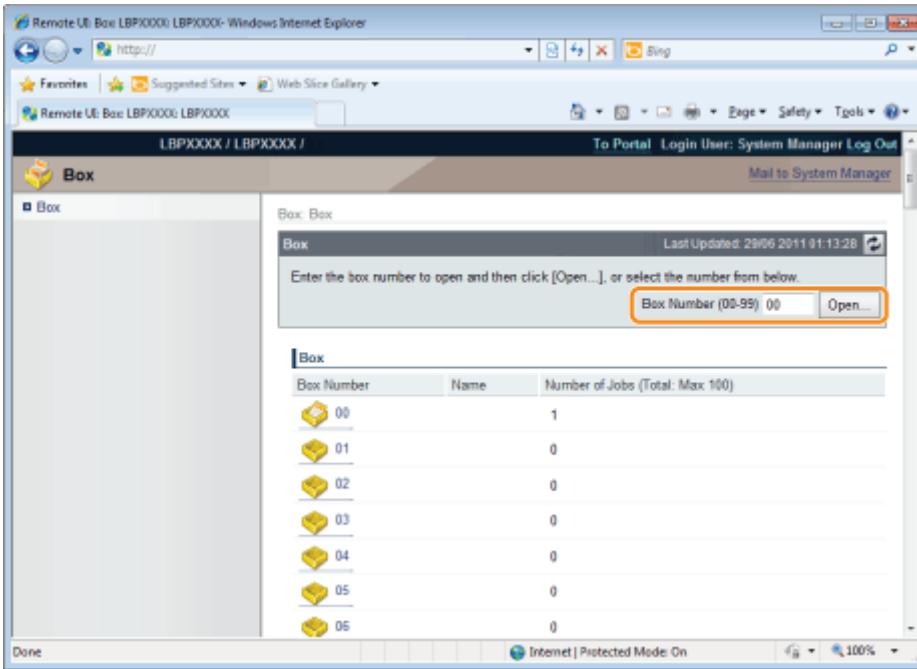

4

Click **[Settings...]**.

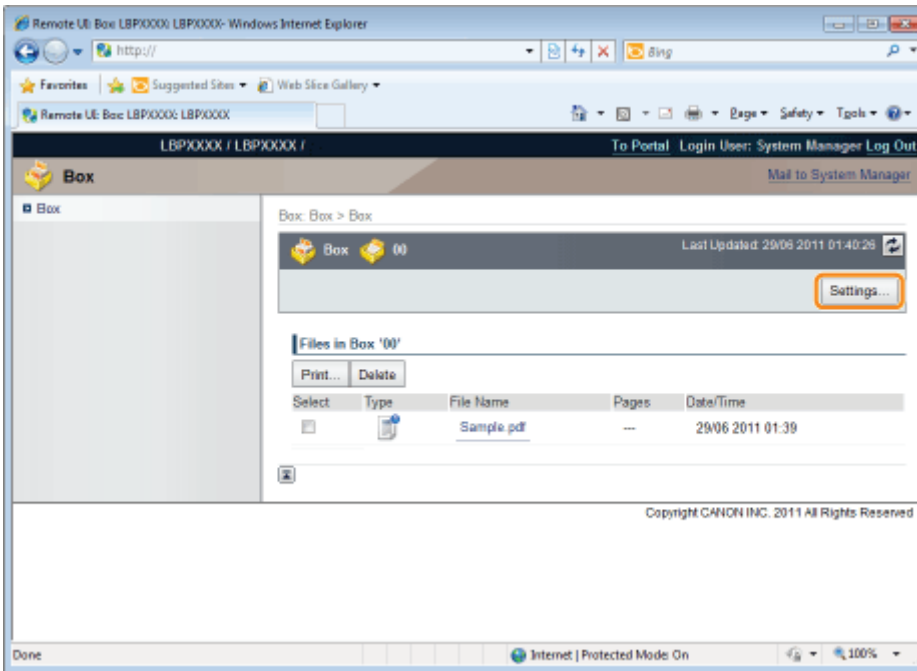

5

Enter the box name in **[Box Name]**.

Up to 32 characters can be entered.

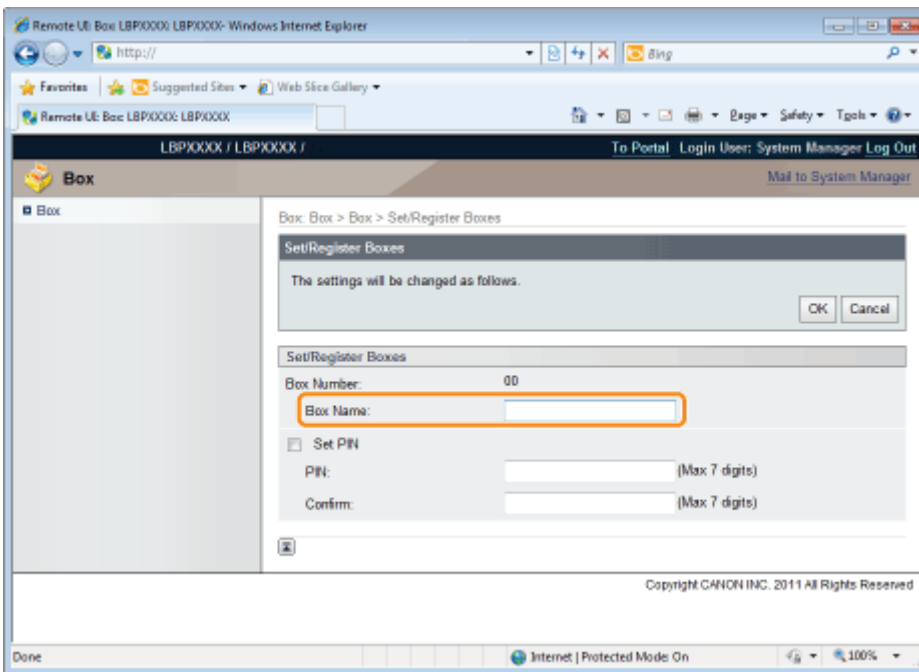

6

Specify the password.

When specifying a password for a box

- (1) Select the [Set PIN] check box.

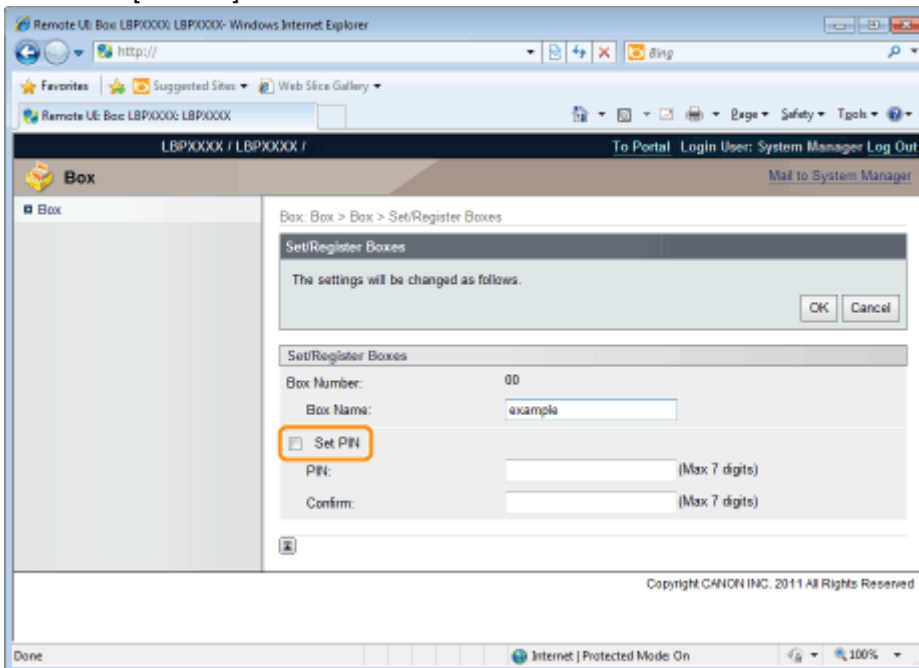

- (2) Enter the password that you want to specify in [PIN], and then enter the same number in [Confirm] as the one you entered in [PIN].

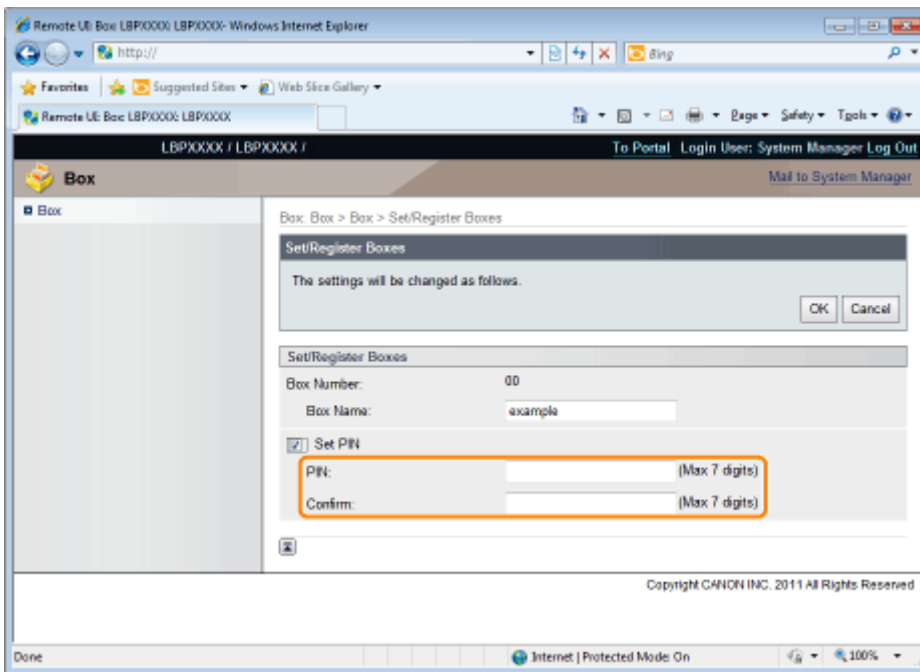

When not specifying a password for a box

Clear the [Set PIN] check box.

† In [PIN] and [Confirm], you can enter a number of 1 to 7 digits. When the first digit is "0", the remaining sequence of digits constitutes the PIN number.

7

Click [OK].

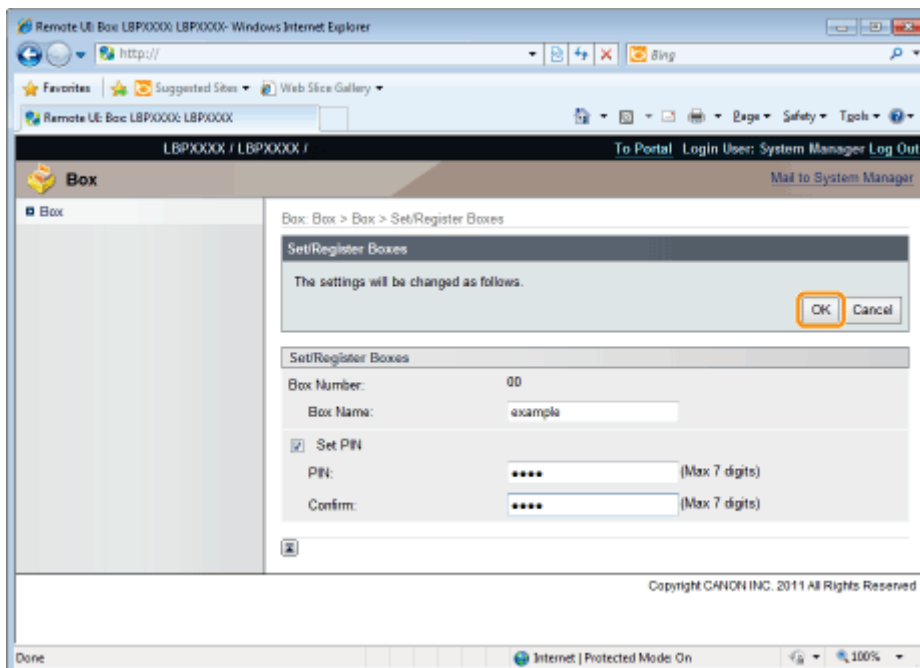

Giving Priority to a Print Job (Interrupt Printing) (LBP6680x Only)

04L9-07A

This mode is used for pausing the job currently being processed and start printing the specified job on ahead. The paused print jobs are saved on the SD card in the printer and printed again after the print job that interrupted is completed.

Select [Interrupt Print] from [Output Method] in the printer driver, and then print.

 **NOTE**

If a print job for interrupt printing has already being processed

You cannot give priority anymore to another print job.

Configuring the Network Settings (Sharing the Printer)

04L9-07C

Checking Your Network Environment

❖ Checking Your Network Environment



Network Settings for the Printer
(Common to Each Protocol)

❖ Network Settings for the Printer (Common to Each Protocol)

❖ Network Settings for the Printer (TCP/IP)

Setting the IP Address (IP v. 4)

❖ Setting the IP Address (IP v. 4)



Configuring the Protocol Settings

❖ Configuring the Protocol Settings



Setting IP v. 6 (if necessary)

❖ Setting IP v. 6 (if necessary)



Configuring a Computer that Performs Printing

❖ Configuring a Computer that Performs Printing

❖ Network Settings for the Printer (NetWare) (LBP6680x Only)

Configuring NetWare

❖ Configuring NetWare



Configuring the Protocol Settings

❖ Configuring the Protocol Settings

❖ Network Settings for the Printer (SMB) (LBP6680x Only)

Configuring the Protocol Settings

❖ Configuring the Protocol Settings



Configuring a Computer that Performs Printing

❖ Configuring a Computer that Performs Printing

➤ Network Settings for the Printer (AppleTalk)



Checking Your Network Environment

04L9-07E

Check the network environment to which the printer is connected and perform the requisite tasks referring to the following figures.

➤ **Example of a Windows Network**

➤ **Example of a Macintosh Network**

➤ **Example of a UNIX Network**

➤ **Example of a Network Using a Variety of Computers**

Example of a Windows Network

04L9-07F

- When the NetWare Server is on the Network
- When the NetWare Server is not on the Network

When the NetWare Server is on the Network

In the network environment as shown in the following figure, TCP/IP or NetWare can be used.

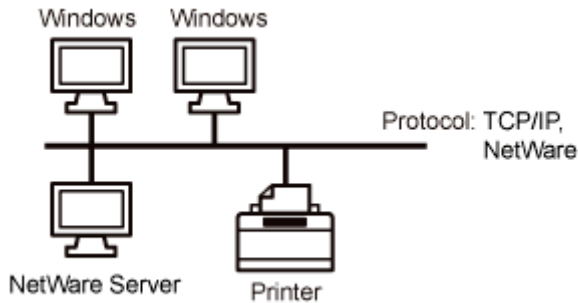

See the following and perform the requisite tasks according to the protocol to be used.

Network Settings for the Printer (Common to Each Protocol)

- "Changing the Network Transmission Speed or Transfer Mode"
- "Specifying the Setting for Startup Waiting Time"

Network Settings for the Printer (TCP/IP)

- "Setting the IP Address (IP v. 4)"
- "Configuring the Protocol Settings"
- "Setting IP v. 6"
- "Configuring a Computer that Performs Printing"

Network Settings for the Printer (NetWare) (LBP6680x Only)

- "Configuring NetWare"
- "Configuring the Protocol Settings"

Network Settings for the Printer (SMB) (LBP6680x Only)

- "Configuring the Protocol Settings"

When the NetWare Server is not on the Network

In the network environment as shown in the following figure, TCP/IP can be used.

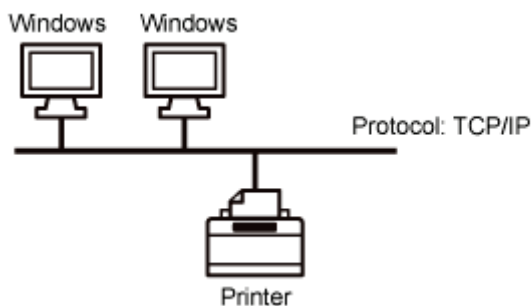

See the following and perform the requisite tasks according to the protocol to be used.

Network Settings for the Printer (Common to Each Protocol)

- "Changing the Network Transmission Speed or Transfer Mode"

- "Specifying the Setting for Startup Waiting Time"

Network Settings for the Printer (TCP/IP)

- "Setting the IP Address (IP v. 4)"
- "Configuring the Protocol Settings"
- "Setting IP v. 6"
- "Configuring a Computer that Performs Printing"

Network Settings for the Printer (SMB) (LBP6680x Only)

- "Configuring the Protocol Settings"

IMPORTANT

About SMB printing

You can use SMB printing only when an SD card is installed.

NOTE

To manage the printer effectively

By performing the above tasks, computers on a network can be connected to the printer directly. When using a TCP/IP protocol, you can manage the printer effectively by specifying Windows on the network as the print server.

For details on the procedure for configuring the print server, see "Printer Driver Installation Guide."

- ↑ For details on the procedure for viewing "Printer Driver Installation Guide", see "[Installation](#)."

About NetBEUI

This printer does not support NetBEUI.

Example of a Macintosh Network

04L9-07H

A Macintosh network can use either of an AppleTalk protocol or TCP/IP protocol.

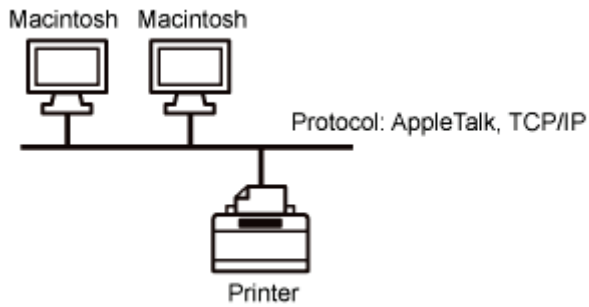

See the following and perform the requisite tasks according to the protocol to be used.

Network Settings for the Printer (Common to Each Protocol)

- ❖ "Changing the Network Transmission Speed or Transfer Mode"
- ❖ "Specifying the Setting for Startup Waiting Time"

Network Settings for the Printer (AppleTalk)

- ❖ "Macintosh Network Settings"
- ❖ "Configuring the Protocol Settings"
- ❖ "Configuring a Computer that Performs Printing"

Network Settings for the Printer (TCP/IP)

- ❖ "Setting the IP Address (IP v. 4)"
- ❖ "Configuring the Protocol Settings"
- ❖ "Setting IP v. 6"
- ❖ "Configuring a Computer that Performs Printing"

IMPORTANT

About a LocalTalk network

This printer does not support a Macintosh LocalTalk network.

Example of a UNIX Network

04L9-07J

A UNIX network uses a TCP/IP protocol.

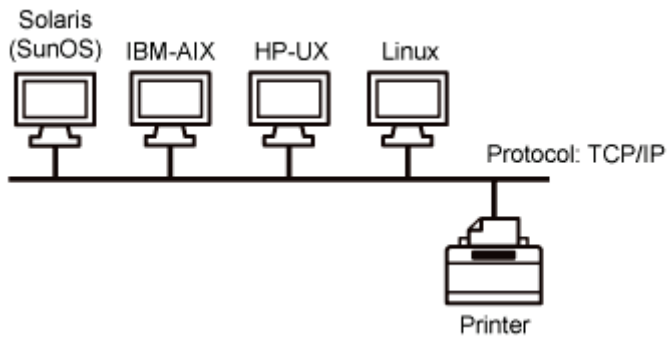

See the following and perform the requisite tasks.

Network Settings for the Printer (Common to Each Protocol)

- ❖ "Changing the Network Transmission Speed or Transfer Mode"
- ❖ "Specifying the Setting for Startup Waiting Time"

Network Settings for the Printer (TCP/IP)

- ❖ "Setting the IP Address (IP v. 4)"
 - ❖ "Configuring the Protocol Settings"
 - ❖ "Setting IP v. 6"
 - ❖ "Configuring a Computer that Performs Printing"
-

Example of a Network Using a Variety of Computers

04L9-07K

If there are a variety of computers on a network, specify the settings appropriate to each computer.

For example, if you are using Windows and Macintosh on the same network, perform both "Example of a Windows Network" and "Example of a Macintosh Network."

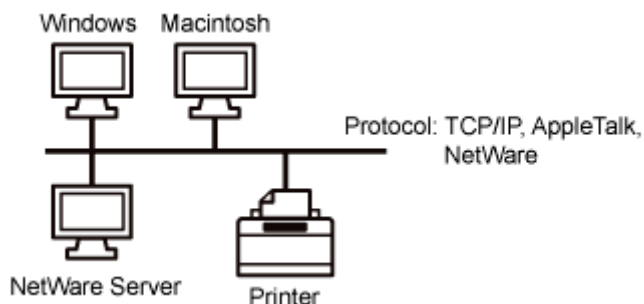

See the following and perform the requisite tasks according to the protocol to be used.

Network Settings for the Printer (Common to Each Protocol)

- ❏ "Changing the Network Transmission Speed or Transfer Mode"
- ❏ "Specifying the Setting for Startup Waiting Time"

Network Settings for the Printer (TCP/IP)

- ❏ "Setting the IP Address (IP v. 4)"
- ❏ "Configuring the Protocol Settings"
- ❏ "Setting IP v. 6"
- ❏ "Configuring a Computer that Performs Printing"

Network Settings for the Printer (NetWare) (LBP6680x Only)

- ❏ "Configuring NetWare"
- ❏ "Configuring the Protocol Settings"

Network Settings for the Printer (SMB) (LBP6680x Only)

- ❏ "Configuring the Protocol Settings"
- ❏ "Configuring a Computer that Performs Printing"

Network Settings for the Printer (AppleTalk)

- ❏ "Macintosh Network Settings"
- ❏ "Configuring the Protocol Settings"
- ❏ "Configuring a Computer that Performs Printing"

IMPORTANT

About SMB printing

You can use SMB printing only when an SD card is installed.

Network Settings for the Printer (Common to Each Protocol)

04L9-07L

This section describes the setting items which are common to each protocol to use this printer in a network environment.

Selecting a Communication Method or Ethernet Type

If you want to fix the type of communication method and Ethernet type, set [Auto Detect] on the Ethernet Drive Setting to [Off]. (This printer can detect the communication method and Ethernet type automatically. Normally, you do not need to specify the setting.)

- ["Changing the Network Transmission Speed or Transfer Mode"](#)

Specifying the Setting for Startup Waiting Time

If the printer cannot be connected to a network, see the following item and specify the setting for the startup waiting time. (Normally, you do not need to change the setting for startup waiting time.)

- ["Specifying the Setting for Startup Waiting Time"](#)

Setting the Spooling Function

You can speed up the exiting time of the computer to which you send print jobs, see the following item and configure the spooler function.

- ["Setting the Spooling Function \(LBP6680x Only\)"](#)

Restricting the Users Who Can Monitor and Change the Settings

If you want to restrict the users who can monitor and change the settings, see the following items and configure the SNMP protocol.

- ["Restricting the Users Who Can Monitor/Change the Settings Using the SNMP Protocol"](#)

Setting IEEE802.1X Authentication

You can specify the settings for using IEEE802.1X authentication with the printer.

- ["Setting IEEE802.1X Authentication"](#)

Network Setting Items

This section describes the setting items which you can change using a Web browser (Remote UI), FTP Client, or NetSpot Device Installer.

- ["Network Setting Items"](#)

Initializing the Network Settings

You can reset the network settings for the printer to the default values.

- ["Initializing the Network Settings"](#)

Checking the MAC Address

You can check the MAC address by printing Network Status Print.

- ["Checking the MAC Address"](#)
-

Changing the Network Transmission Speed or Transfer Mode

04L9-07R

Configure the Ethernet driver for this printer using either of the following methods.

❖ ["Performing the Configuration Using the Printer's Control Panel \(When You First Set it Up\)"](#)

Configure the Ethernet driver using the control panel while checking the display on the printer.

❖ ["Changing the Settings Using Web Browser \(Remote UI\)"](#)

Change the settings for the Ethernet driver by accessing the printer from a Web browser via the network.

 **IMPORTANT**

When configuring the interface first

Use the printer's control panel. After configuring the TCP/IP protocol settings, you can change the settings for the interface using the Web browser (Remote UI).

 **NOTE**

Ethernet

Ethernet is a LAN standard, and this printer supports 10Base-T/100Base-TX/1000Base-T connections. When this printer is used on a network, the Ethernet driver controls the communication method and Ethernet type.

Performing the Configuration Using the Printer's Control Panel (When You First Set it Up)

04L9-075

When configuring the interface using the printer's control panel, use the following menu hierarchy.

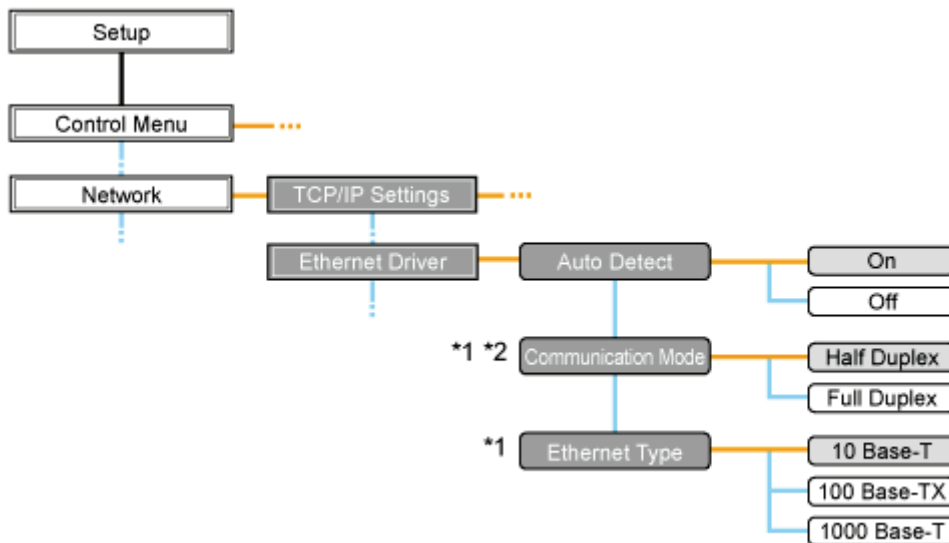

*1 [Communication Mode] and [Ethernet Type] are displayed when [Auto Detect] is set to [Off].

*2 [Communication Mode] appears only when [Ethernet Type] is set to a setting other than [1000 Base-T].

- Pressing [] ( : Settings) displays the common Setup menu.

— indicates that the procedure is performed by pressing [▲] or [▼] on the control panel.



— indicates that the procedure is performed by pressing [OK] on the control panel.

IMPORTANT

After performing the configuration

To enable the settings, perform a hard reset or restart the printer.
For details on a hard reset, see "[Canceling All the Jobs \(Hard Reset\)](#)."

To go back up the hierarchy

Press [] ( : Back).



About the control panel

For details on the control panel, see "[Control Panel](#)."

1

Press [] ( : Settings), select [Network] using [▲] and [▼], and then press [OK].

When the message is displayed, press [OK].

† You can specify the settings when the printer is either online (the  (Online) indicator is on) or offline (the  (Online) indicator is off).

2

Select [Ethernet Driver] using [▲] and [▼], and then press [OK].

3

Configure the Ethernet driver.

- † This printer can detect the communication method and Ethernet type automatically. Normally, set [Auto Detect] to [On]. If you want to fix the communication method and Ethernet type, set [Auto Detect] to [Off].
- † If you are using a hub, match the settings for the hub and the printer. For the settings of the hub you are using, consult your network administrator.

(Example)

- Hub settings
 - Communication mode: Full duplex
 - Ethernet type: 10 Base-T
- Printer settings
 - [Auto Detect]: [Off]
 - [Communication Mode]: [Full Duplex]
 - [Ethernet Type]: [10 Base-T]

When detecting the Ethernet driver automatically (Default)

- (1) Select [Auto Detect] using [▲] and [▼], and then press [OK].
- (2) Select [On] using [▲] and [▼], and then press [OK].

When detecting the Ethernet driver manually

- (1) Select [Auto Detect] using [▲] and [▼], and then press [OK].
- (2) Select [Off] using [▲] and [▼], and then press [OK].
- (3) Select [Communication Mode] using [▲] and [▼], and then press [OK].
- (4) Select an Ethernet communication method appropriate for your network environment using [▲] and [▼], and then press [OK].

[Half Duplex]:	Receives and transmits data alternately, not simultaneously.
[Full Duplex]:	Receives and transmits data simultaneously.

- (5) Select [Ethernet Type] using [▲] and [▼], and then press [OK].
- (6) Select an Ethernet type appropriate for your network environment using [▲] and [▼], and then press [OK].

4

Perform a hard reset or restart the printer.

After performing a hard reset or restarting the printer, the settings are effective.

NOTE

For details on a hard reset

See "[Canceling All the Jobs \(Hard Reset\)](#)."

Changing the Settings Using Web Browser (Remote UI)

04L9-07U

1

Start the Remote UI, and then log in as Administrator.

➤ "Starting the Remote UI"

2

Click [Settings/Registration].

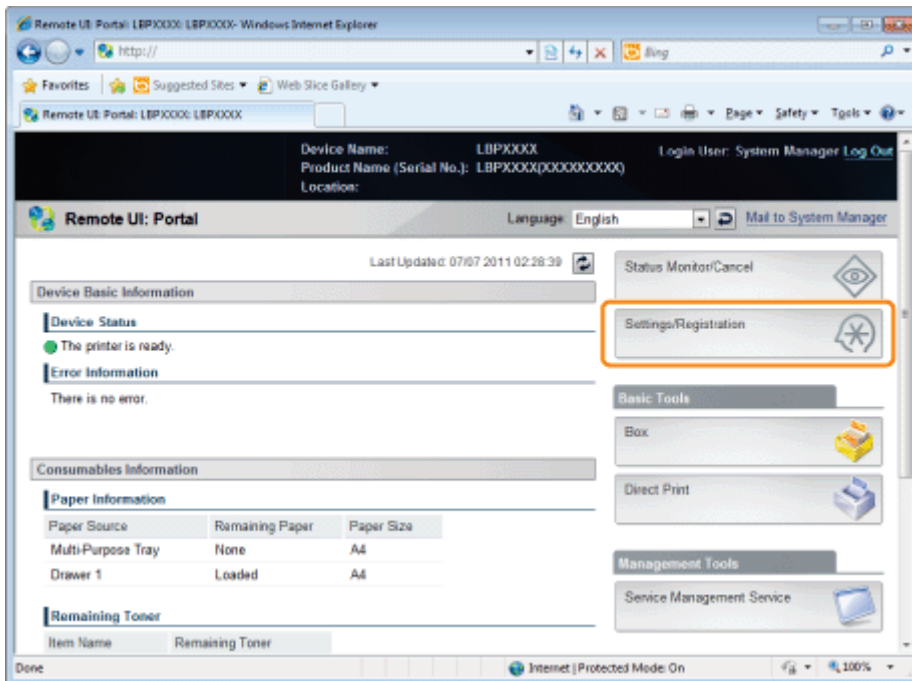

3

Select [Network] from the [Preferences] menu.

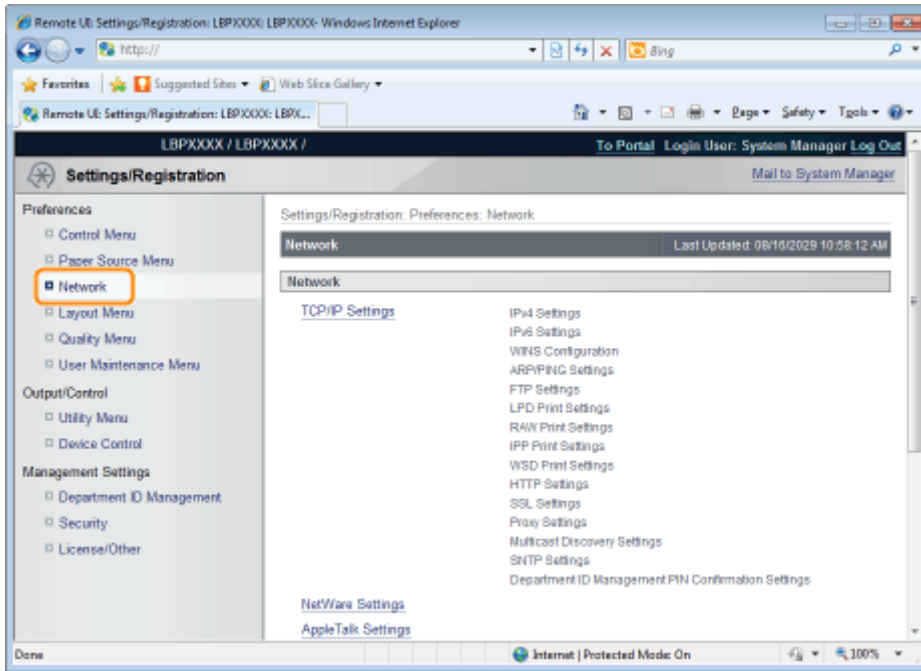

4

Click [Ethernet Driver Settings].

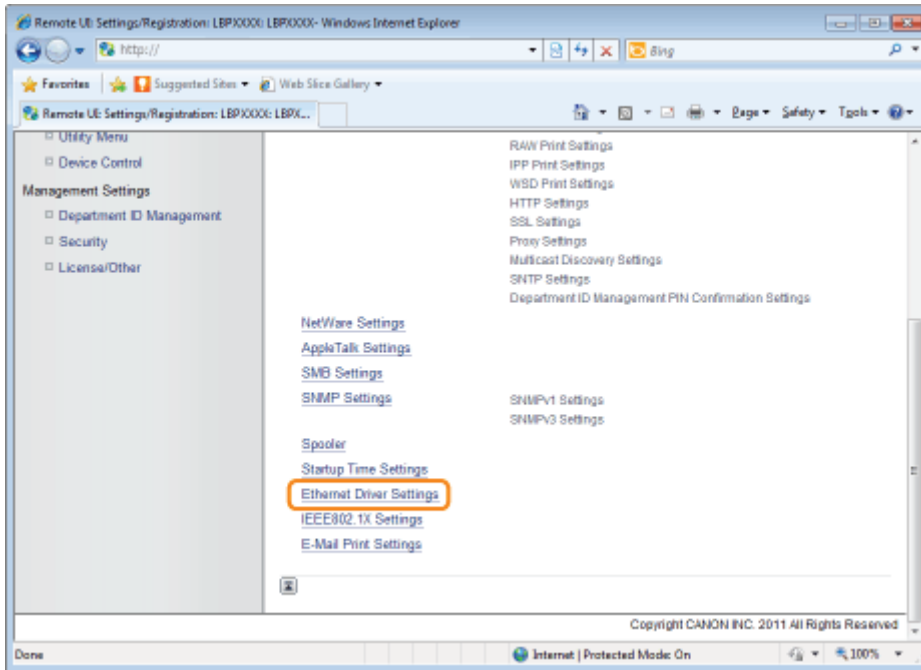

5

Click [Edit...].

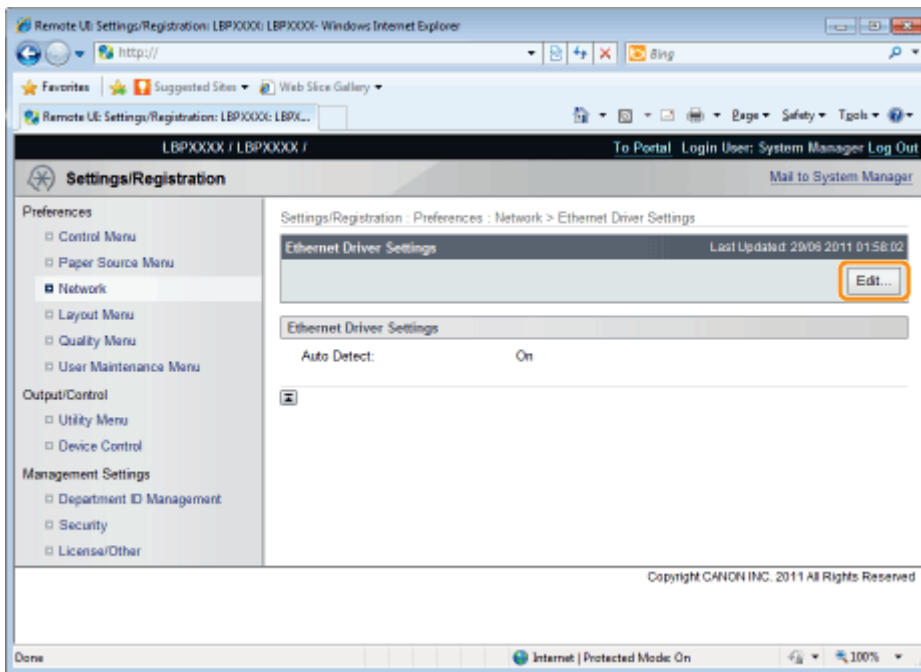

(1) Set the Ethernet driver.

If you want the communication method and Ethernet type to be set automatically, select the [Auto Detect] check box. If you want to fix the settings for communication method and Ethernet type, clear the [Auto Detect] check box, and set the following.

- Using [Communication Mode], select the Ethernet communication method that matches the network environment you are using.

[Half Duplex]	Sending and receiving are not performed simultaneously. They are performed alternately.
[Full Duplex]	Sending and receiving are performed simultaneously.

† If you select half duplex when fixing the Ethernet type, sending and receiving are not performed simultaneously. They are performed alternately. If you select full duplex, sending and receiving are performed simultaneously.

† If you are using a hub, match the settings for the hub and the printer. For the settings of the hub you are using, consult your network administrator.

(Example)

- Hub settings
 - Communication mode: Full duplex
 - Ethernet type: 10 Base-T
- Printer settings
 - [Auto Detect]: [Off]
 - [Communication Mode]: [Full Duplex]
 - [Ethernet Type]: [10 Base-T]

- Using [Ethernet Type], Select the Ethernet type that matches the network environment you are using.

(2) Click [OK].

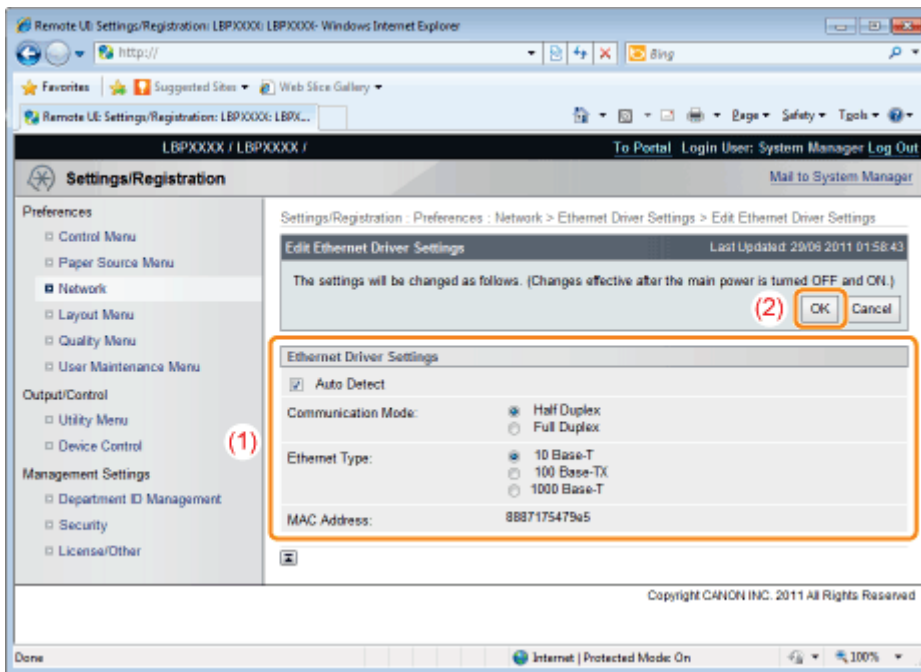

6

Perform a hard reset or restart the printer.

→ After performing a hard reset or restarting the printer, the settings are effective.

NOTE

To perform a hard reset

You can perform a hard reset using the following procedure.

1. Click [Settings/Registration].
2. Select [Device Control] from the [Output/Control] menu.
3. Select [Hard Reset], and then click [Execute].

Setting the Spooling Function (LBP6680x Only)

04L9-07W

Specify the setting for the spooler function using either of the following methods.

➤ ["Performing the Configuration Using the Printer's Control Panel \(the Settings to Be Performed First\)"](#)

Specify the setting for the spooler function using the control panel while checking the display on the printer.

➤ ["Changing the Settings Using Web Browser \(Remote UI\)"](#)

Specify the setting for the spooler function by accessing the printer from a Web browser via the network.

IMPORTANT

When specifying the setting for startup waiting time first

Use the printer's control panel. After configuring the TCP/IP protocol settings, you can change the settings using the Web browser (Remote UI) or FTP Client.

- † Because the options which can be specified vary depending on the software, see "[Network Setting Items](#)" and use each software appropriate to the environment you are using or options that you want to specify.

The Spooling Function

It can only be used when the SD card is installed.

NOTE

Changing the settings using FTP Client

You can also specify the setting for startup waiting time using FTP Client.

- ["FTP Client"](#)

Performing the Configuration Using the Printer's Control Panel (the Settings to Be Performed First)

04L9-07X

When configuring the spooler function using the printer's control panel, use the following menu hierarchy.

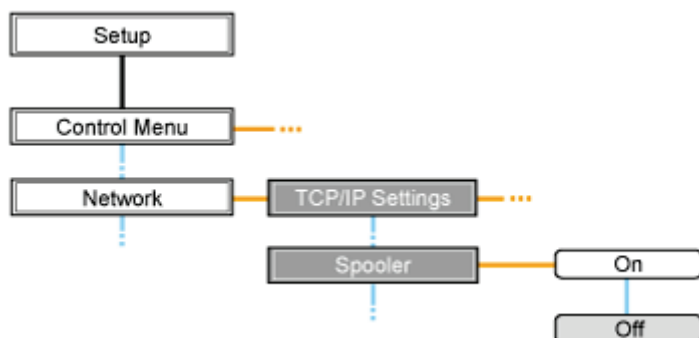

- Pressing [] ( : Settings) displays the common Setup menu.

 indicates that the procedure is performed by pressing [▲] or [▼] on the control panel.

 indicates that the procedure is performed by pressing [OK] on the control panel.



IMPORTANT

After performing the configuration

To enable the settings, perform a hard reset or restart the printer.

For details on a hard reset, see "[Canceling All the Jobs \(Hard Reset\)](#)."

To go back up the hierarchy

Press [] ( : Back).



About the control panel

For details on the control panel, see "[Control Panel](#)."

1

Press [] ( : Settings), select [Network] using [▲] and [▼], and then press [OK].

When the message is displayed, press [OK].

† You can specify the settings when the printer is either online (the  (Online) indicator is on) or offline (the  (Online) indicator is off).

2

Select [Spooler] using [▲] and [▼], and then press [OK].

3

Specify the setting for the spooler function using [▲] and [▼], and then press [OK].

4

Perform a hard reset or restart the printer.

After performing a hard reset or restarting the printer, the settings are effective.

NOTE

For details on a hard reset

See "[Canceling All the Jobs \(Hard Reset\)](#)."

Changing the Settings Using Web Browser (Remote UI)

04L9-07Y

1

Start the Remote UI, and then log in as Administrator.

➤ "Starting the Remote UI"

2

Click [Settings/Registration].

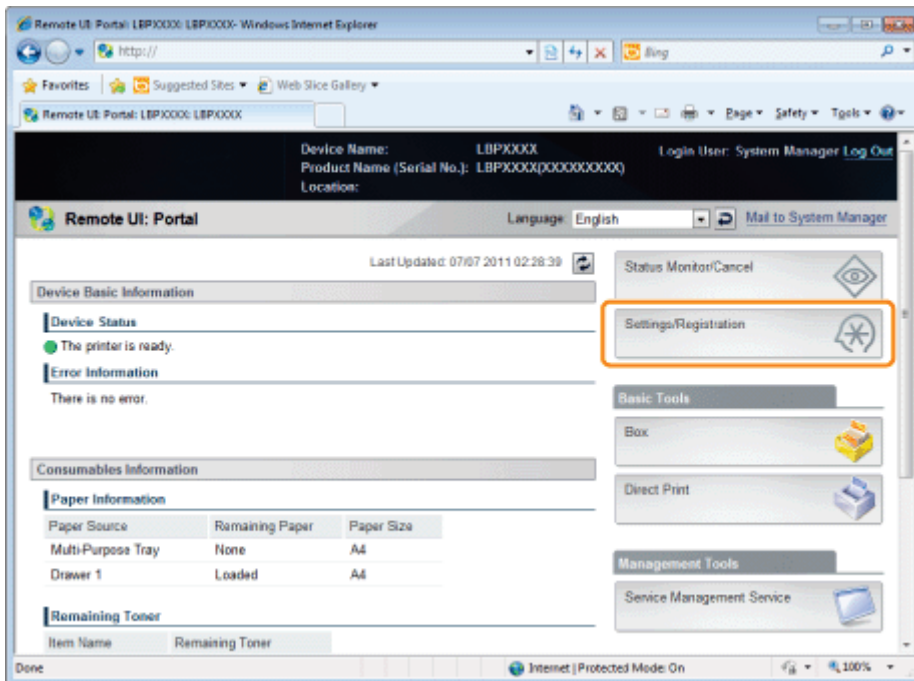

3

Select [Network] from the [Preferences] menu.

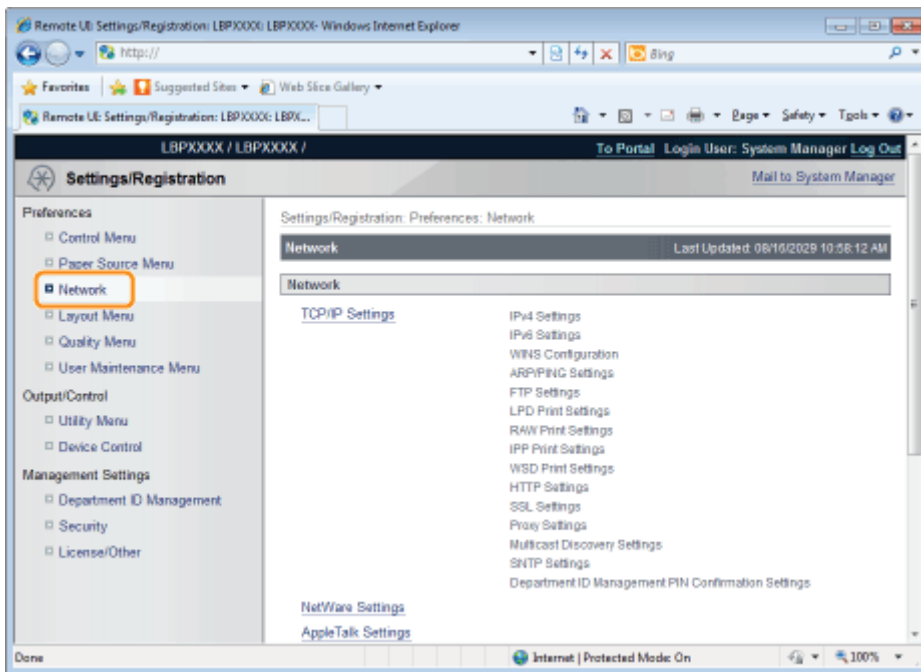

4

Click [Spooler].

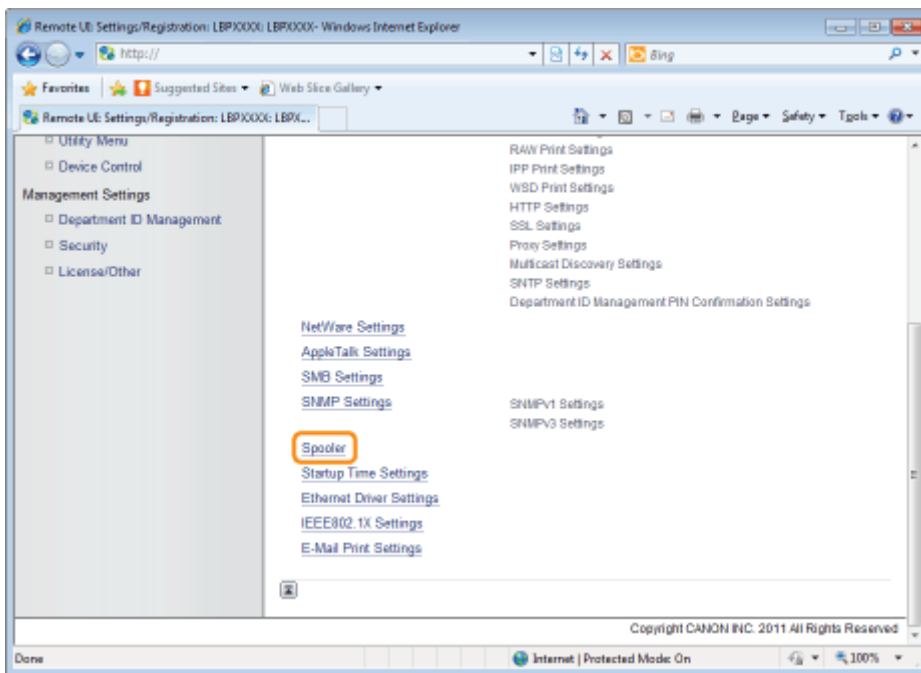

5

Click [Edit...].

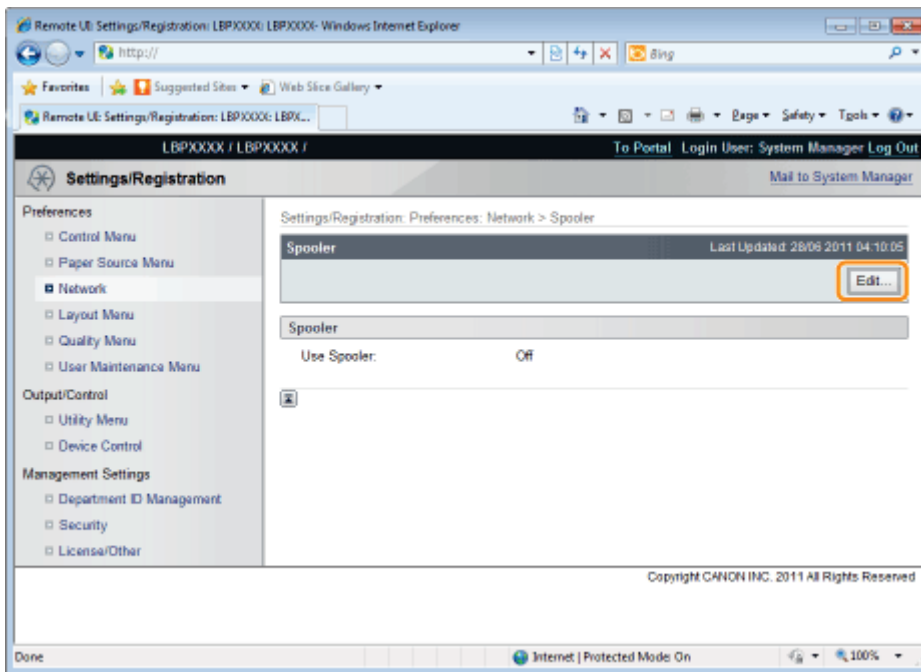

6

Specify the setting for the spooler function.

- (1) When using the spooling function, select the [Use Spooler] check box.
- (2) Click [OK].

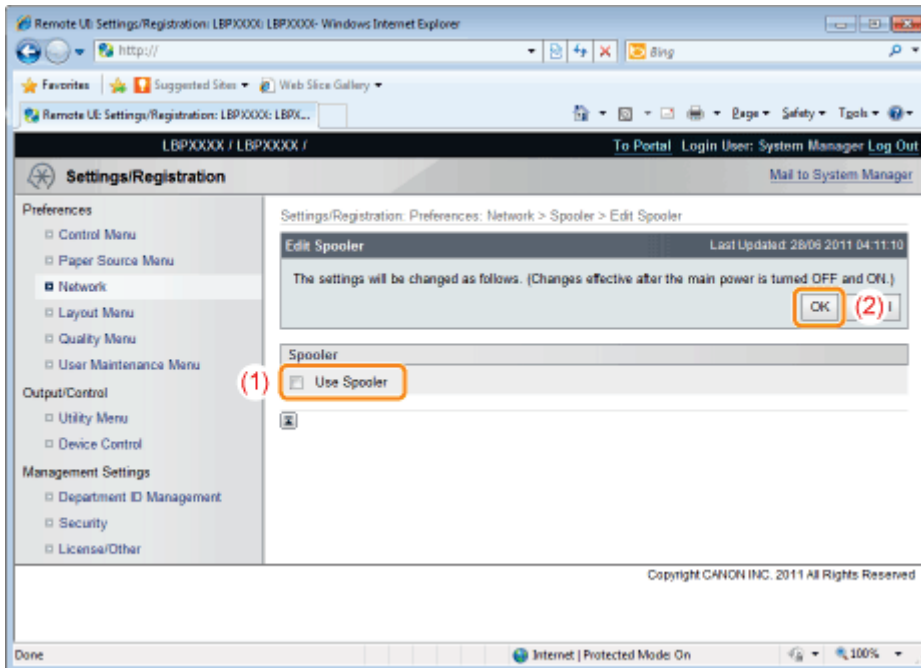

7

Perform a hard reset or restart the printer.

→ After performing a hard reset or restarting the printer, the settings are effective.

NOTE

To perform a hard reset

You can perform a hard reset using the following procedure.

1. Click [Settings/Registration].
 2. Select [Device Control] from the [Output/Control] menu.
 3. Select [Hard Reset], and then click [Execute].
-

Specifying the Setting for Startup Waiting Time

04L9-080

Specify the setting for startup waiting time using either of the following methods.

❖ ["Performing the Configuration Using the Printer's Control Panel"](#)

Specify the setting for startup waiting time using the control panel while checking the display on the printer.

❖ ["Changing the Settings Using Web Browser \(Remote UI\)"](#)

Specify the setting for startup waiting time by accessing the printer from a Web browser via the network.

† Normally, you do not need to change the setting for startup waiting time (the time from when you turn the printer ON to when the printer starts communication). Specify the setting for the startup waiting time only when the printer cannot be connected to the network.

 **NOTE**

If this printer is connected to a switching hub etc.

The printer may not be able to be connected to the network even when the network settings are correct. This is because the printer and hub cannot communicate each other immediately after this printer is connected to the hub due to a spanning tree process. In this case, it is necessary to set a delay before establishing the network connection with the printer using this setting. For details on the functions of a switching hub, contact the manufacturer of the switching hub.

Changing the settings using FTP Client

You can also specify the setting for startup waiting time using FTP Client.

❖ ["FTP Client"](#)

Performing the Configuration Using the Printer's Control Panel

04L9-081

When configuring the startup waiting time using the printer's control panel, use the following menu hierarchy.

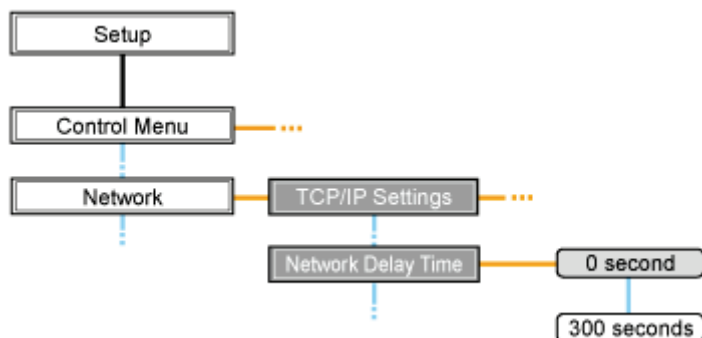

- Pressing [] ( : Settings) displays the common Setup menu.

— indicates that the procedure is performed by pressing [▲] or [▼] on the control panel.

— indicates that the procedure is performed by pressing [OK] on the control panel.



IMPORTANT

After performing the configuration

To enable the settings, perform a hard reset or restart the printer.

For details on a hard reset, see "[Canceling All the Jobs \(Hard Reset\)](#)."

To go back up the hierarchy

Press [] ( : Back).



About the control panel

For details on the control panel, see "[Control Panel](#)."

1

Press [] ( : Settings), select [Network] using [▲] and [▼], and then press [OK].

When the message is displayed, press [OK].

† You can specify the settings when the printer is either online (the  (Online) indicator is on) or offline (the  (Online) indicator is off).

2

Select [Network Delay Time] using [▲] and [▼], and then press [OK].

3

Specify the setting for startup waiting time using [▲] and [▼], and then press [OK].

Set a delay of between 0 and 300 seconds from the time the printer is turned ON until it begins communicating.

4

Perform a hard reset or restart the printer.

After performing a hard reset or restarting the printer, the settings are effective.

 **NOTE**

For details on a hard reset

See ["Canceling All the Jobs \(Hard Reset\)."](#)

Changing the Settings Using Web Browser (Remote UI)

04L9-082

1

Start the Remote UI, and then log in as Administrator.

➤ "Starting the Remote UI"

2

Click [Settings/Registration].

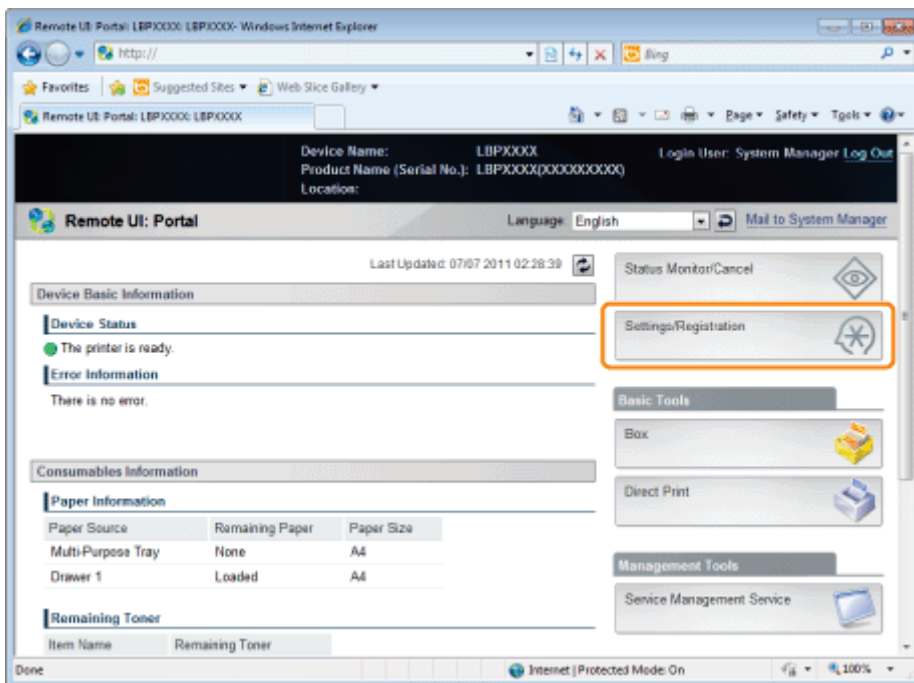

3

Select [Network] from the [Preferences] menu.

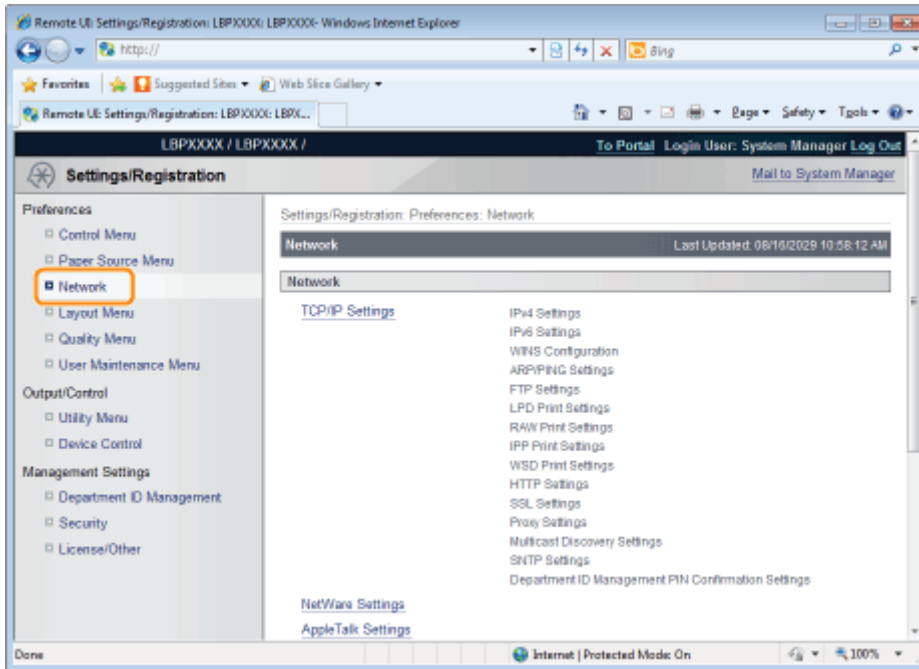

4

Click [Startup Time Settings].

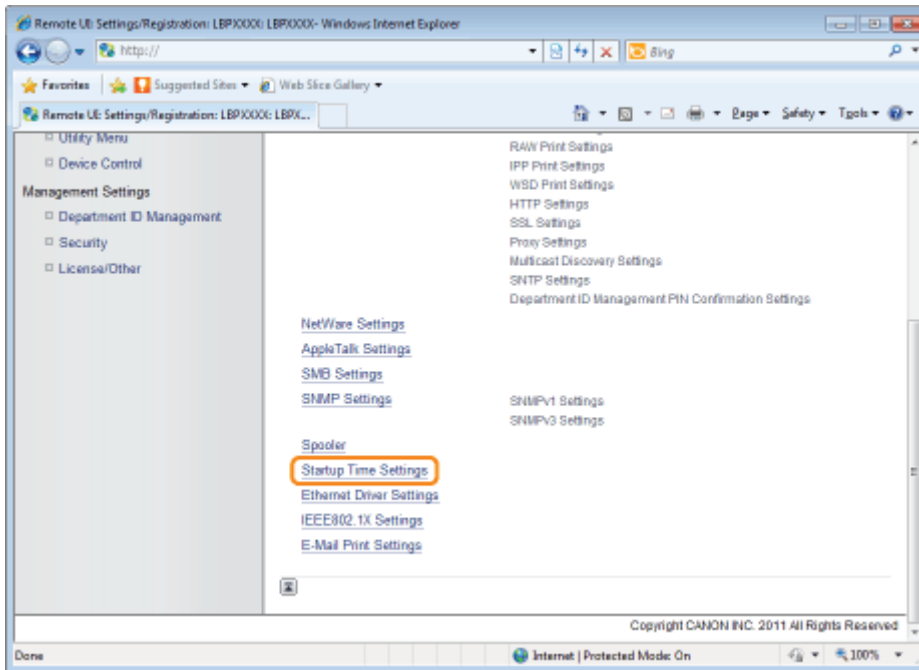

5

Click [Edit...].

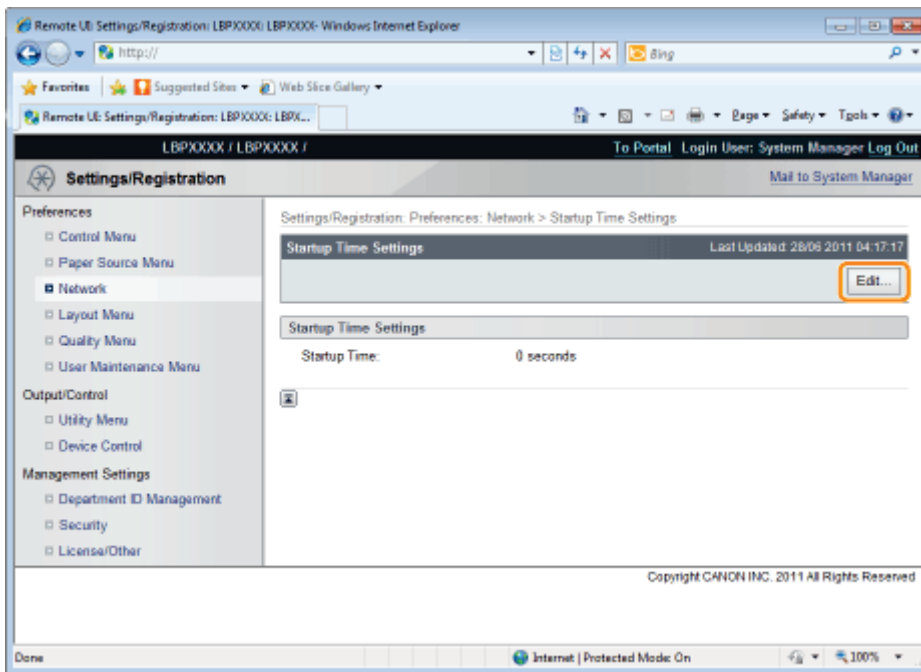

6

Specify the setting for startup time.

- (1) Enter the Startup Time from when you turn the printer ON to when the printer starts communication (0 to 300 seconds).
- (2) Click [OK].

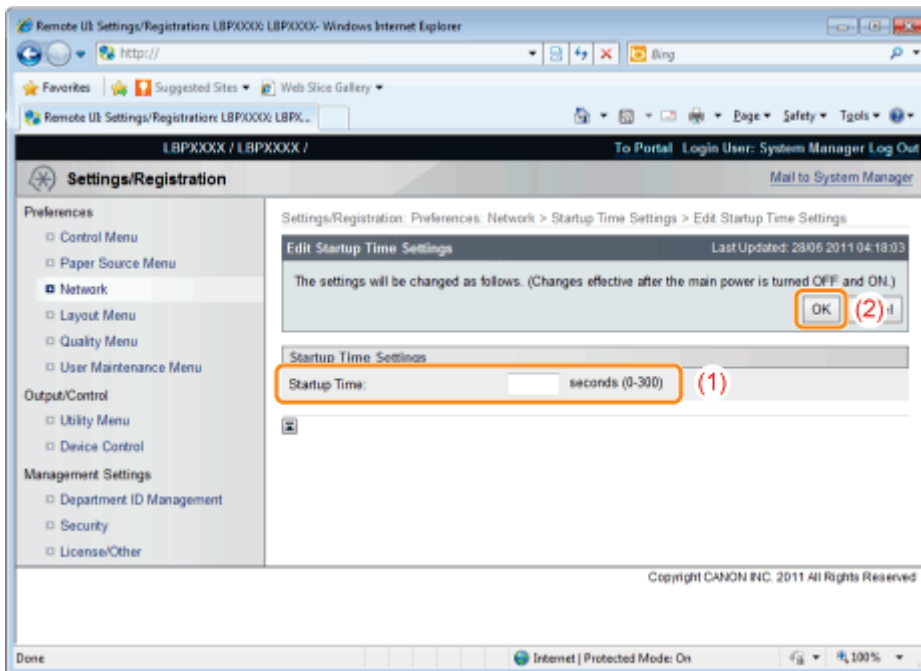

7

Perform a hard reset or restart the printer.

→ After performing a hard reset or restarting the printer, the settings are effective.

NOTE

To perform a hard reset

You can perform a hard reset using the following procedure.

1. Click [Settings/Registration].
 2. Select [Device Control] from the [Output/Control] menu.
 3. Select [Hard Reset], and then click [Execute].
-

Restricting the Users Who Can Monitor/Change the Settings Using the SNMP Protocol

04L9-083

You can restrict the users who can specify and browse the settings using the SNMP protocol using a Web browser (Remote UI).

1 Start the Remote UI, and then log in as Administrator.

❖ "Starting the Remote UI"

2 Click [Settings/Registration].

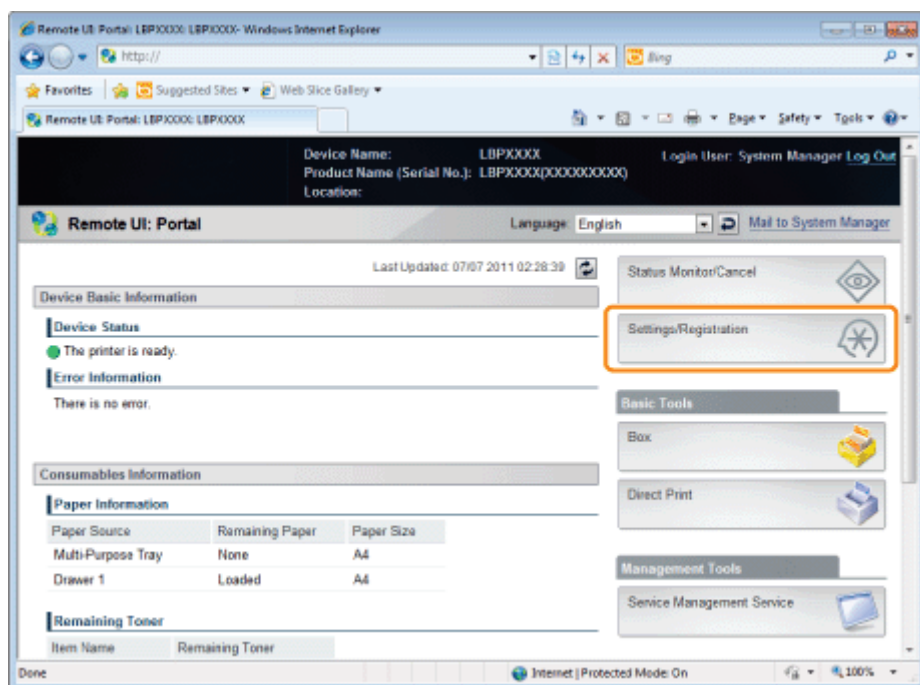

3 Select [Network] from the [Preferences] menu.

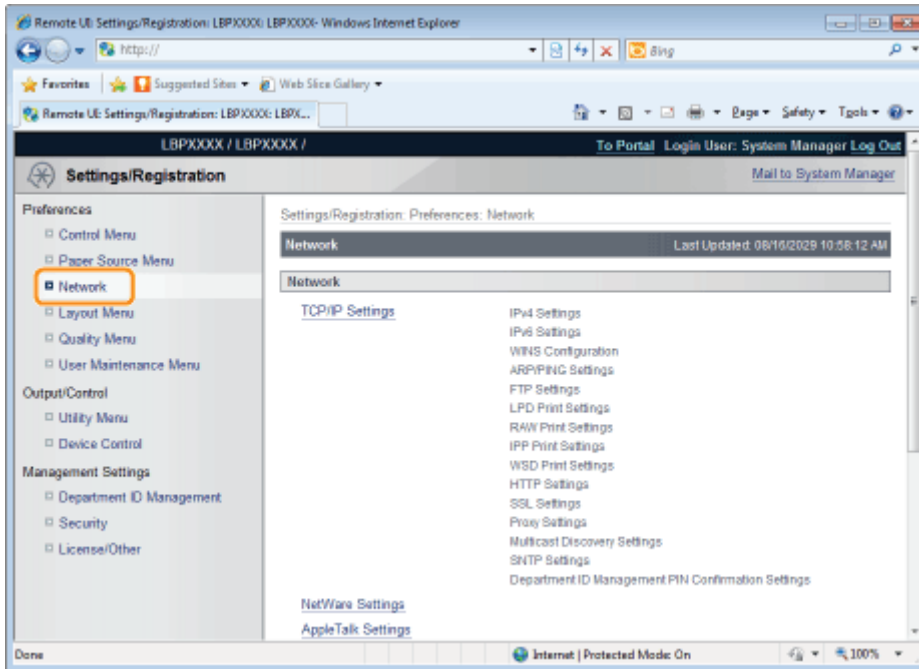

4

Click [SNMP Settings].

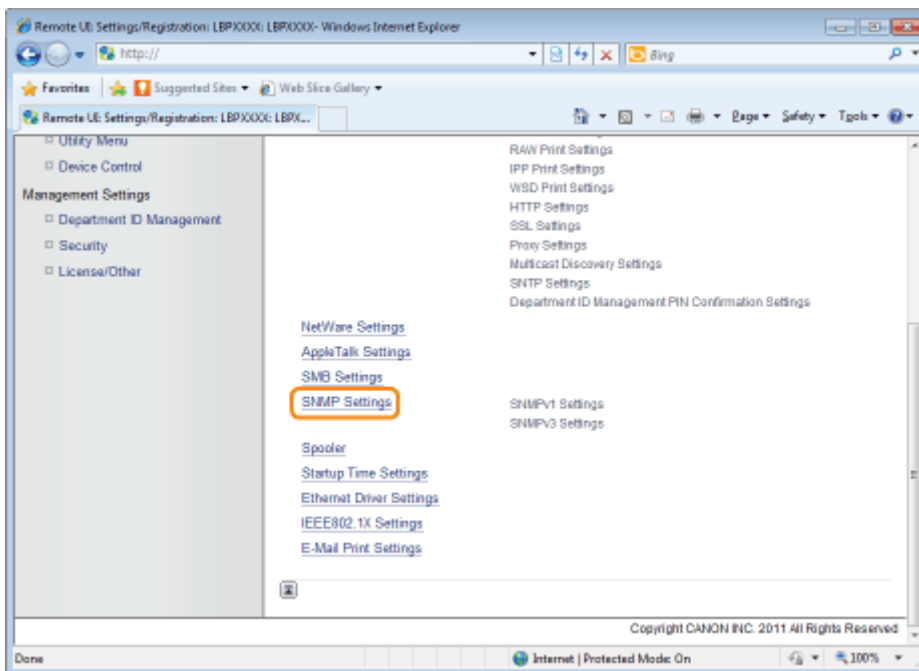

5

Click [Edit...].

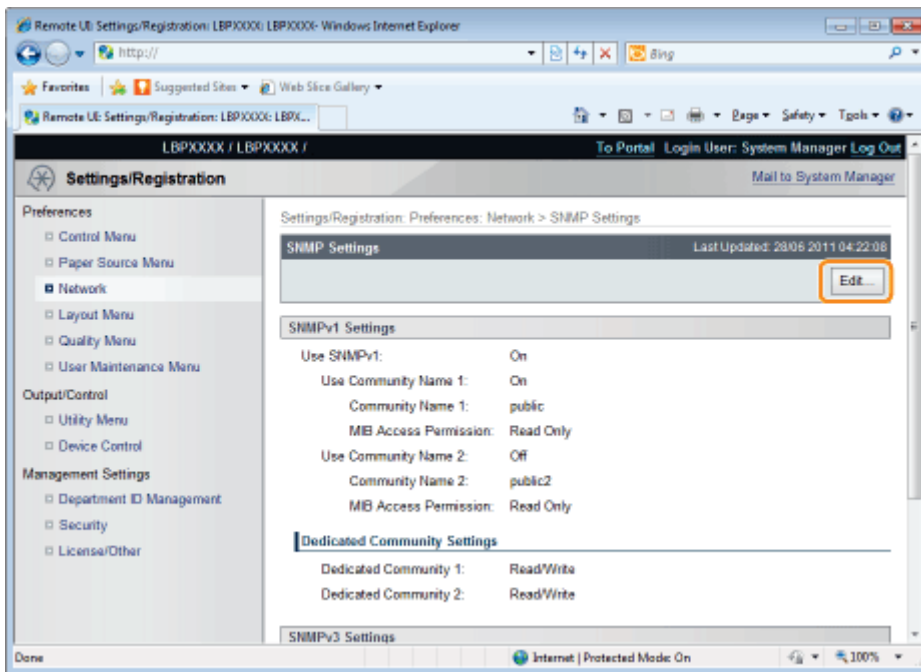

6

Specify the settings for SNMP.

- ❖ Configuring the SNMP Protocol
- ❖ Specifying User Information to Be Used in the SNMP v. 3 Protocol
- ❖ Specifying Context Information to Be Used in the SNMP v. 3 Protocol

Configuring the SNMP Protocol

(1) Configure the SNMP v. 1 protocol.

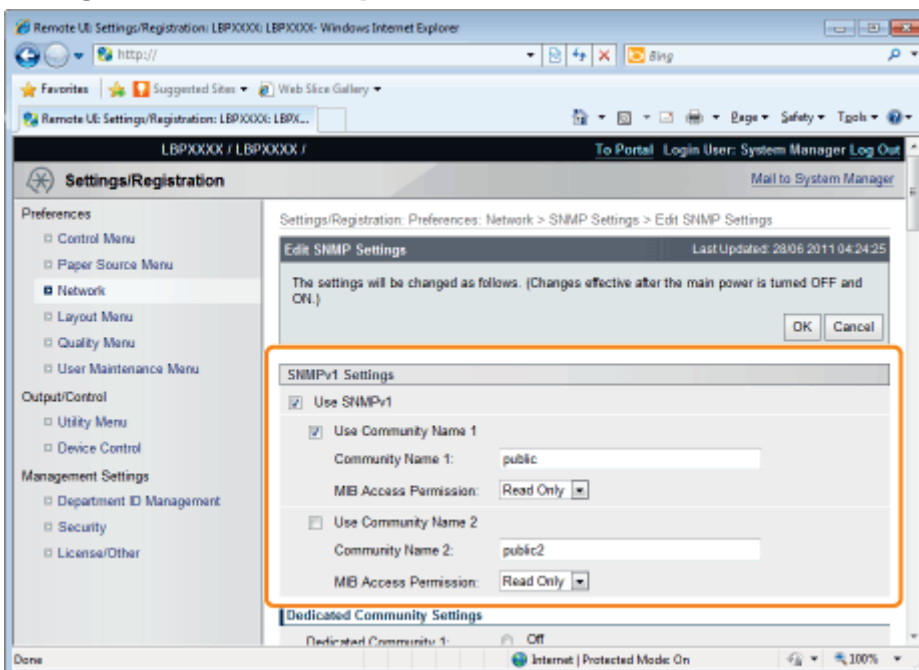

When using SNMPv1 protocol

- a. Select the [Use SNMPv1] check box.
- b. When using Community Name 1, select the check box for [Use Community Name 1], and set the following items.
 - Set the SNMP Community Name in [Community Name 1]. Up to 32 characters can be entered. The default setting is [public].
 - Using [MIB Access Permission], select whether to operate the SNMPv1 agent in one of [Read/Write] or

[Read Only] modes.

- c. When using Community Name 2, select the check box for [Use Community Name 2], and set the following items.
 - Set the SNMP Community Name in Community Name 2. Up to 32 characters can be entered. The default setting is [public2].
 - Using [MIB Access Permission], select whether to operate the SNMPv1 agent in one of [Read/Write] or [Read Only] modes.

When you are not using SNMPv1 protocol

Clear the [Use SNMPv1] check box.

IMPORTANT

When the [Use SNMPv1] check box is cleared

The following problems may occur.

- * You may not be able to use some functions of Canon utility software or to use the software properly due to an error occurring.
- * You may not be able to specify or browse each option for this printer from utility software that uses the SNMP v. 1 protocol to obtain information.

If you clear the [Use SNMPv1] check box, set it after consulting with the network administrator.

(2) Set a dedicated community.

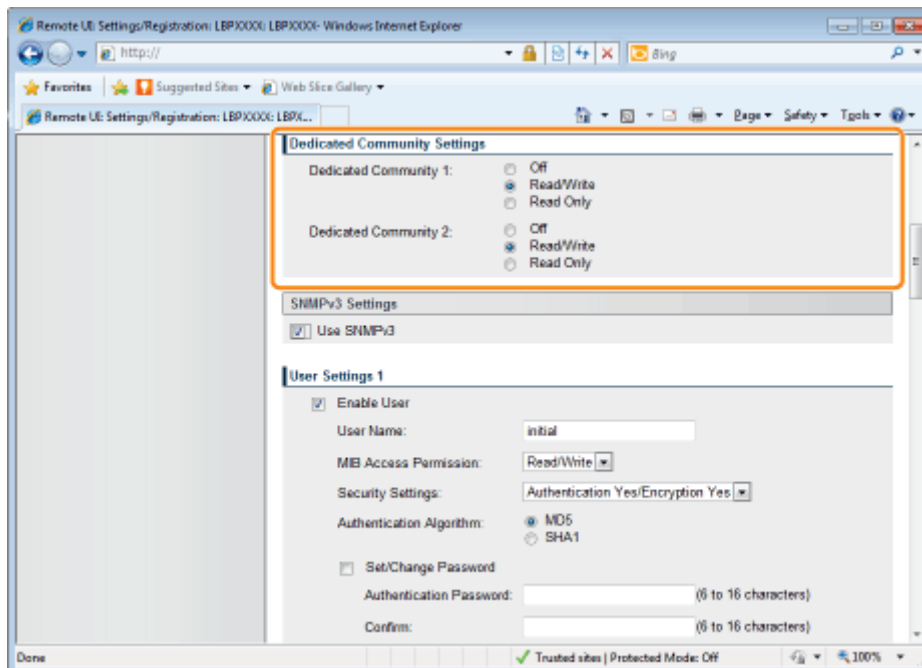

- a. In the [Dedicated Community 1] settings, select from [Off], [Read/Write] or [Read Only].
- b. In the [Dedicated Community 2] settings, select from [Off], [Read/Write] or [Read Only].

(3) Configure the SNMP v. 3 protocol.

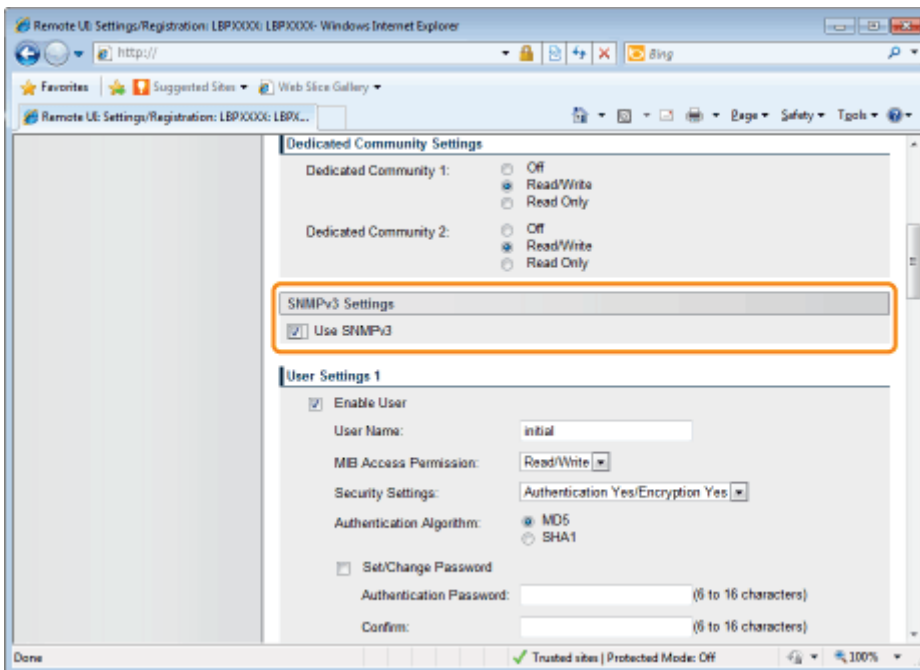

When using SNMPv3 protocol

- a. Select the [Use SNMPv3] check box.
- b. When setting user information used by SNMPv3 protocol, set user information using [User Settings 1] to [User Settings 5].
 - † See "[Specifying User Information to Be Used in the SNMP v. 3 Protocol](#)" for the method for setting user information.
- c. When setting context information used by SNMPv3 protocol, set context information using [Context Settings].
 - † See "[Specifying Context Information to Be Used in the SNMP v. 3 Protocol](#)" for the method for setting context information.

When you are not using SNMPv3 protocol

Clear the [Use SNMPv3] check box.

(4) Specify [Obtain Printer Management Information from Host] as needed.

If the [Obtain Printer Management Information from Host] check box is selected, when the printer driver is installed in Windows Vista/7/Server 2008, port monitoring by SNMP is activated automatically.

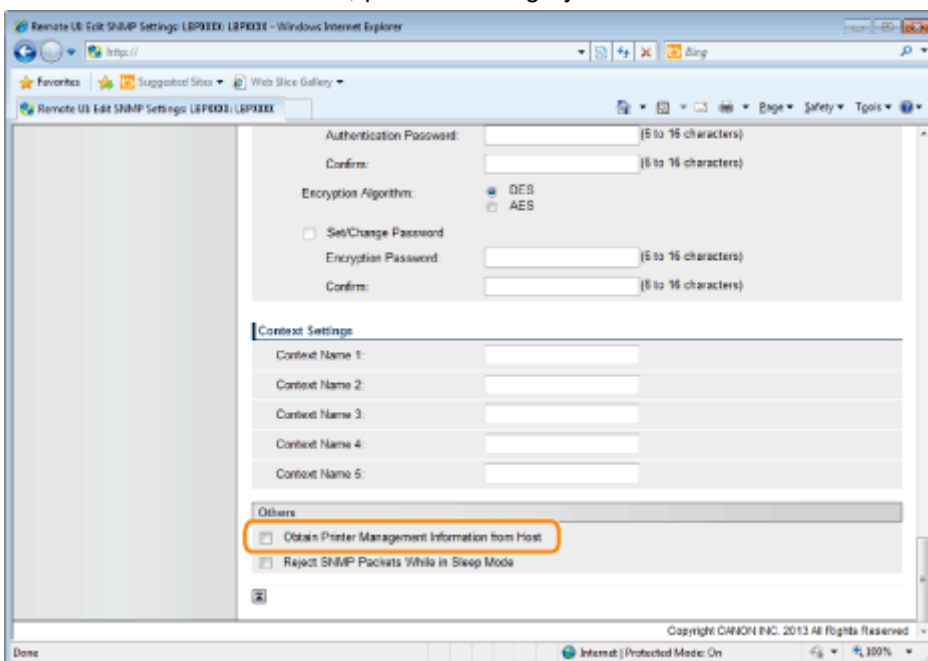

NOTE

The port monitoring function by SNMP

The port monitoring function by SNMP is a function of Standard TCP/IP Port, and it periodically obtains printer management information such as information about print applications and ports, using SNMP.

(5) Make a setting for rejecting to receive SNMP packets while in sleep mode, as necessary.

If you select the check box for [Reject SNMP Packets While in Sleep Mode], you may be unable to access the printer from Canon software (iW Series) or applications using the SNMP protocol.

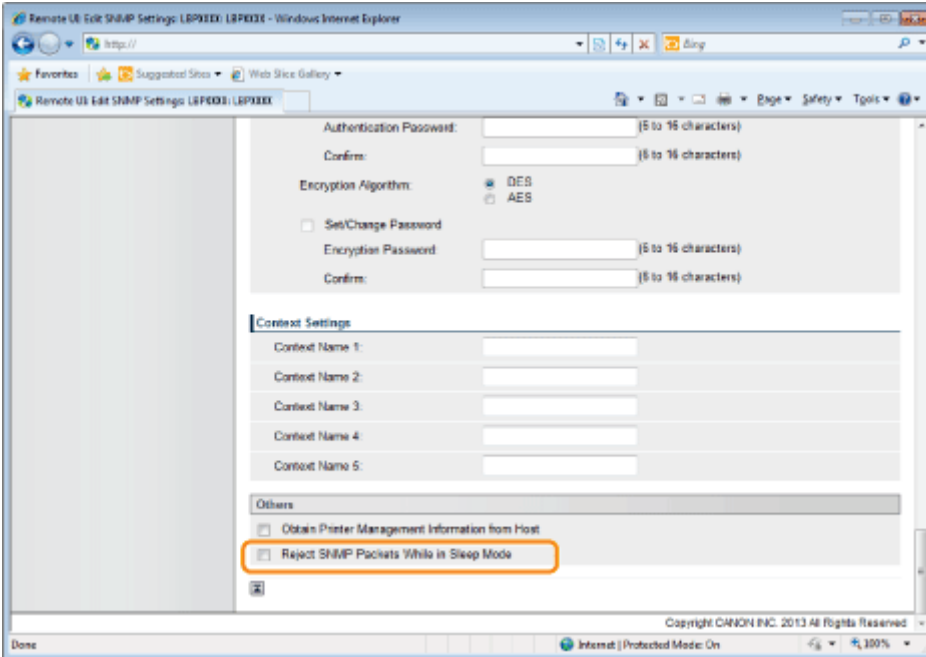

(6) Proceed to Step 7.

Specifying User Information to Be Used in the SNMP v. 3 Protocol

(1) Specify the user information to be used in the SNMP v. 3 protocol.

- ❖ If You Want to Register/Edit User Information
- ❖ If You Want to Change the Status (Valid/Invalid) of User Information

If You Want to Register/Edit User Information

1. Select the [Enable User] check box under [User Settings 1].

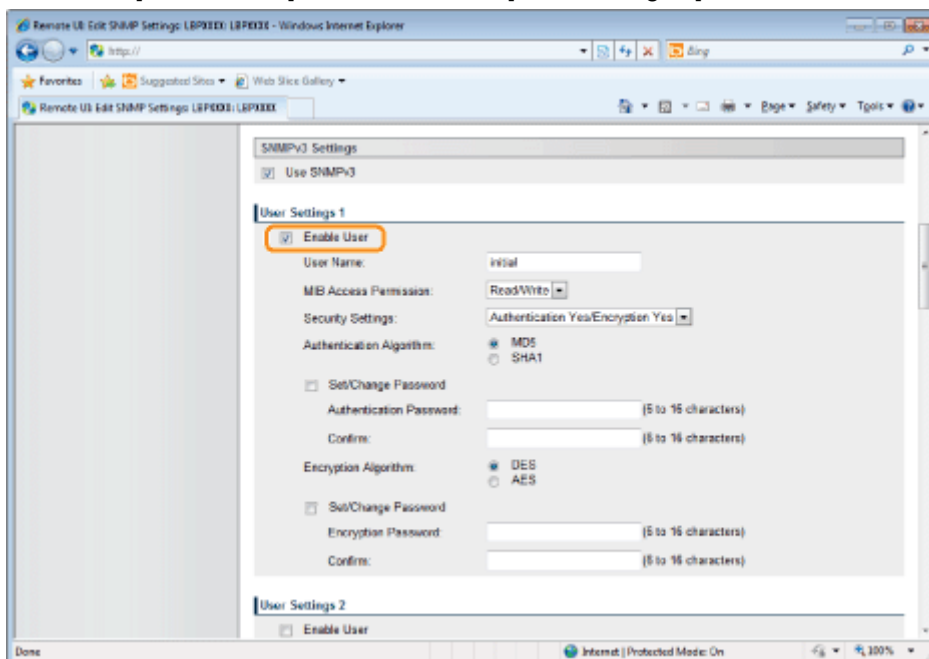

2. In [User Name], enter the user name to be used in the SNMP v. 3 protocol. Up to 32 alphanumeric characters can be entered.

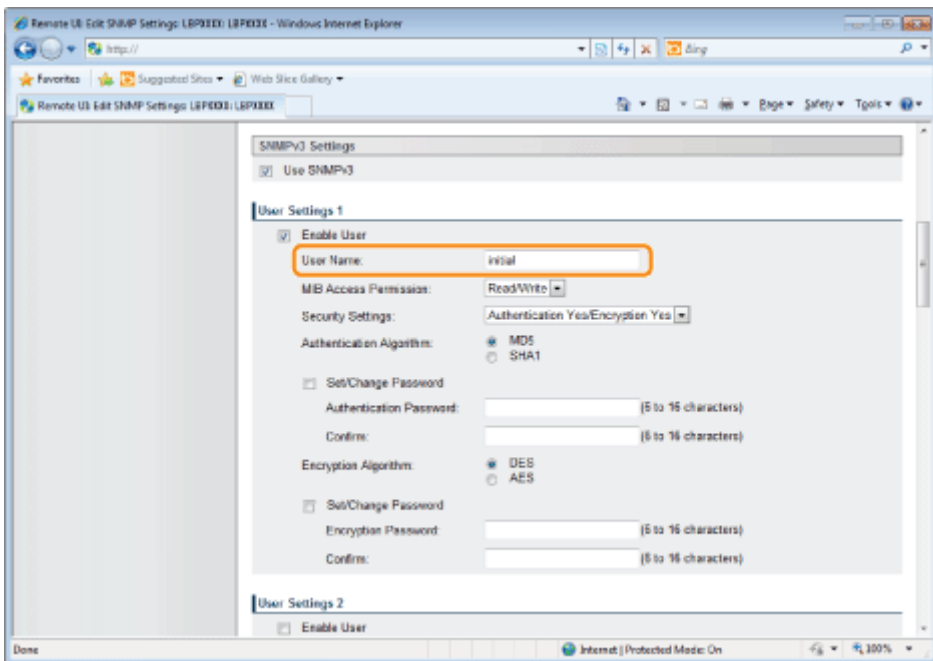

3. For [MIB Access Permission], select in which mode the SNMP v. 3 agent can operate, [Read/Write] or [Read Only].

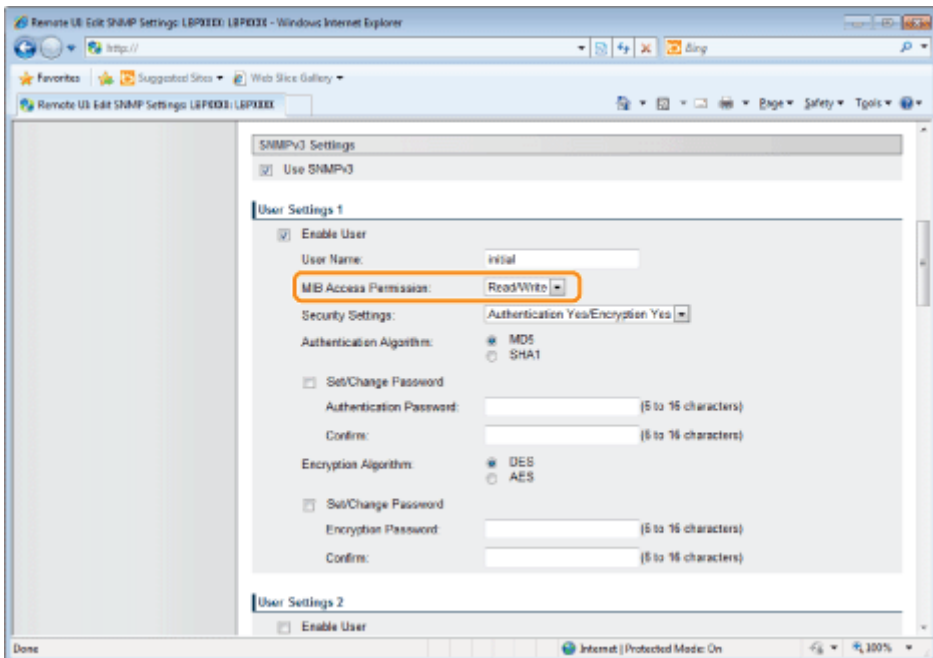

4. Under [Security Settings], select from [Authentication Yes/Encryption Yes], [Authentication Yes/Encryption No] or [Authentication No/Encryption No] for the security used by SNMPv3.

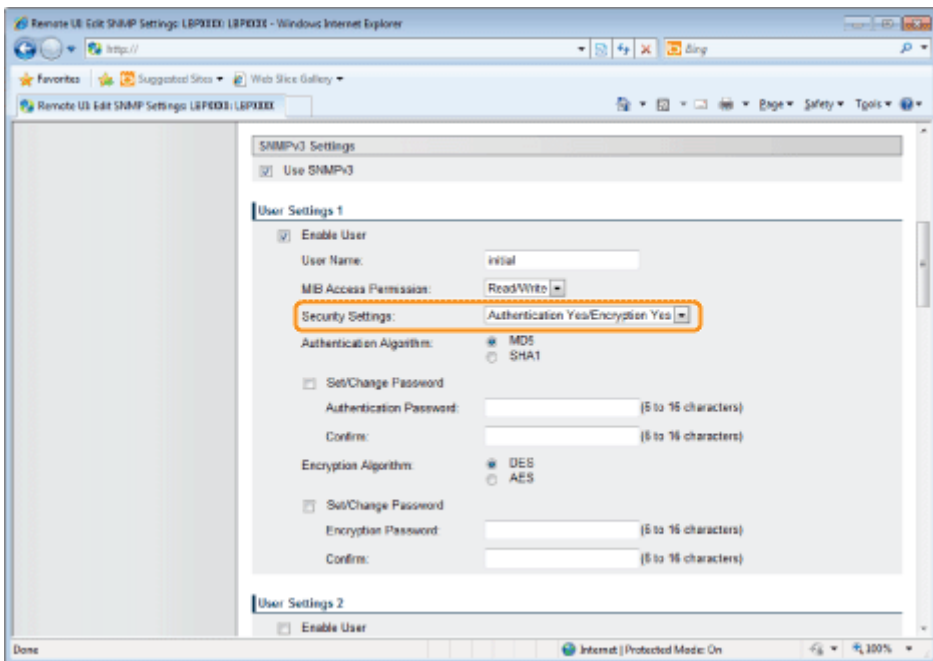

5. If [Authentication Yes/Encryption Yes] or [Authentication Yes/Encryption No] is set for [Security Settings], select [MD5] or [SHA1] for [Authentication Algorithm] as the authentication algorithm used by SNMPv3.

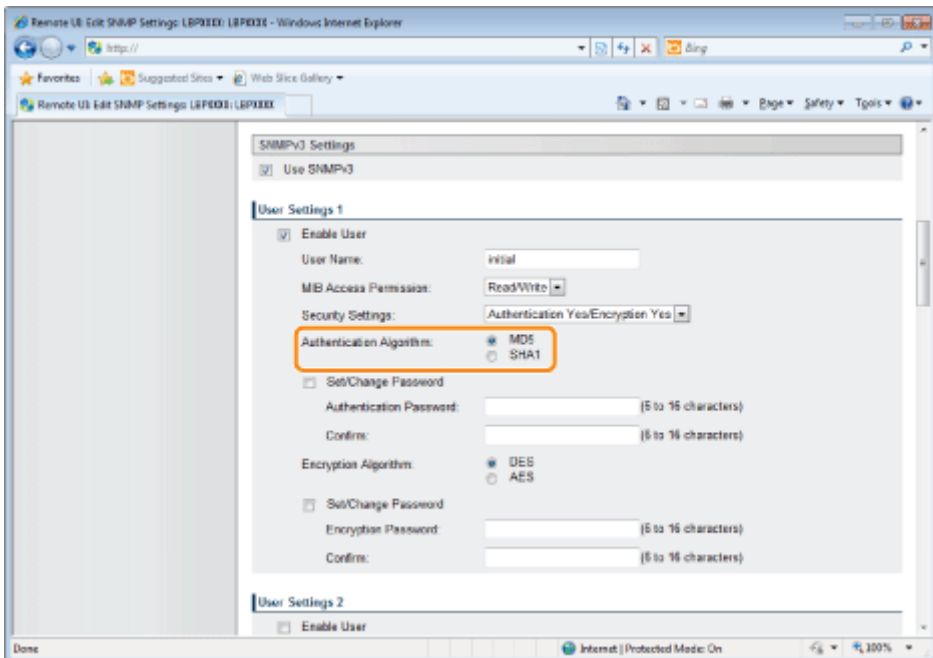



6. When [Authentication Yes/Encryption Yes] is set using [Security Settings], set an authentication password.

[Authentication Password]: Enter the password to be used for the authentication function of the authentication algorithm. 6 to 16 alphanumeric characters can be entered.

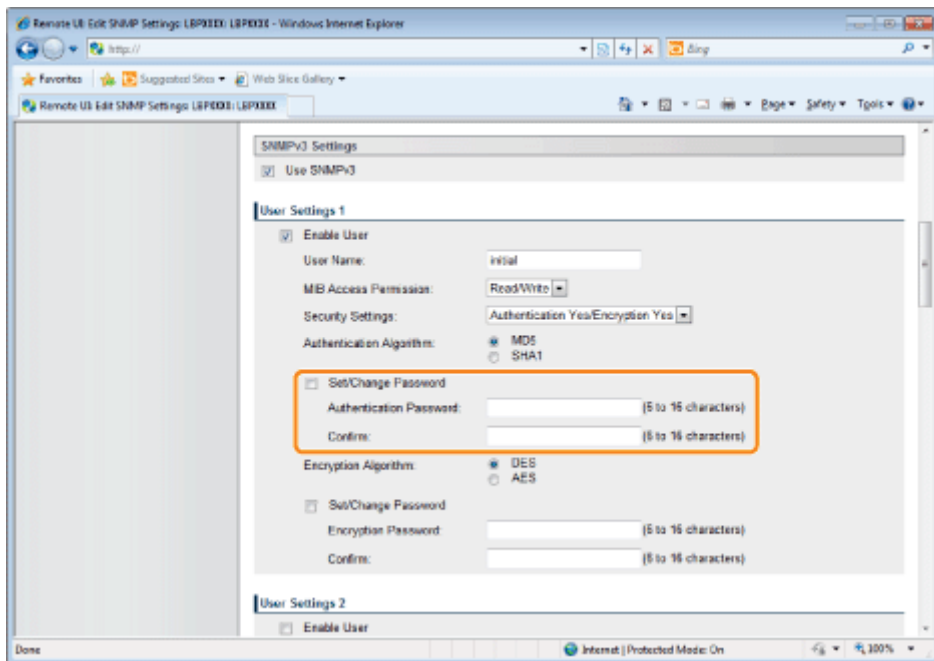
[Confirm]: To confirm the password, enter the entered [Authentication Password] again.



† If the SSL encrypted communication function is not used, this item cannot be set by the Remote UI. Either enable the SSL encrypted communication function, or set from the control panel using the following procedure.

- a. Press [] ( : Settings), select [Network] → [SNMP v. 3 Settings], and then set [SNMP v. 3] to [On].
- b. Set each password using [Auth. Password] from [User Settings 1] to [User Settings 5].

For details on the SSL encrypted communication function, see "[Setting Keys and Certificates.](#)"

7. If [Security Settings] are set to [Authentication Yes/Encryption Yes], set an encrypted password. Set [Encryption Algorithm] to [DES] or [AES].

[Encryption Password]: Enter the password to be used for the encryption function of the encryption algorithm. 6 to 16 alphanumeric characters can be entered.

[Confirm]: To confirm the password, enter the entered [Encryption Password] again.

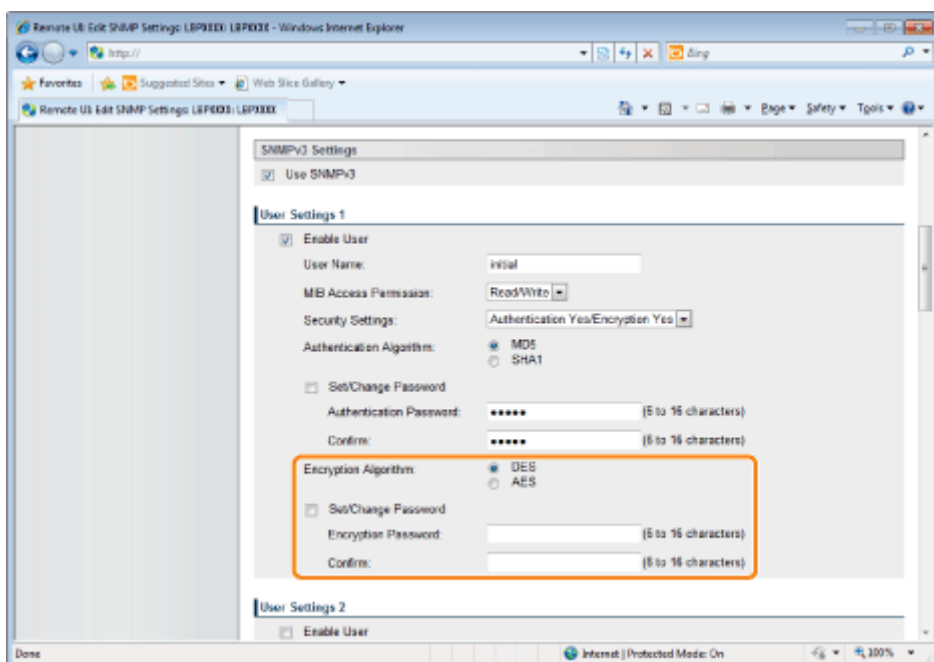

† If the SSL encrypted communication function is not used, this item cannot be set by the Remote UI. Either enable the SSL encrypted communication function, or set from the control panel using the following procedure.

- a. Press [] ( : Settings), select [Network] → [SNMP v. 3 Settings], and then



set [SNMP v. 3] to [On].

b. Set each password using [Auth. Password] from [User Settings 1] to [User Settings 5].

For details on the SSL encrypted communication function, see "[Setting Keys and Certificates.](#)"

8. Set [User Settings 2] to [User Settings 5] using the same procedure as needed.

If You Want to Change the Status (Valid/Invalid) of User Information

To enable registered user information, select the [Enable User] check box at the top of the targeted user information.

To disable registered user information, clear the [Enable User] check box at the top of the targeted user information.

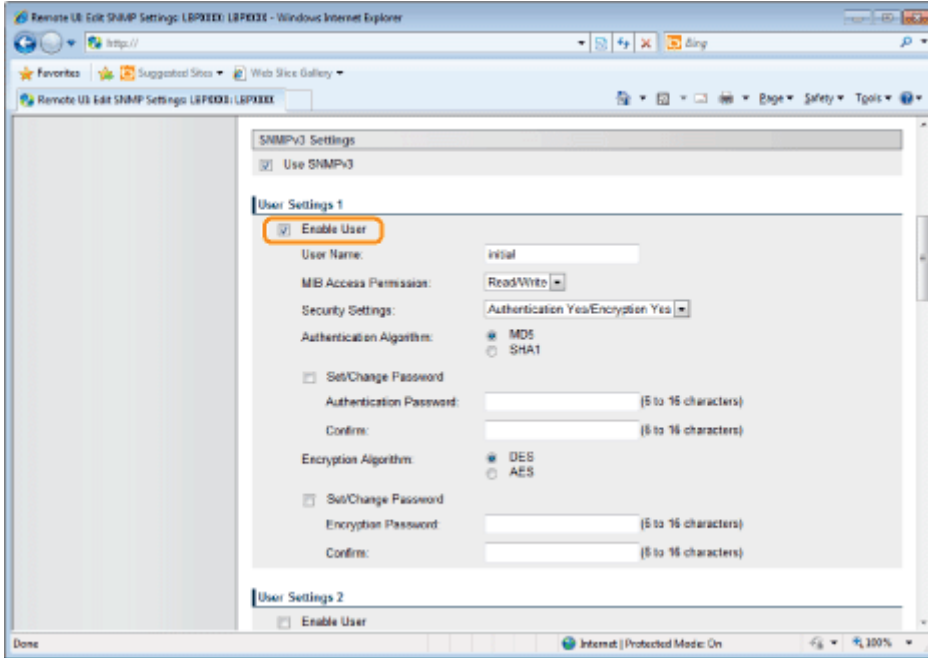

(2) Proceed to Step 7.

Specifying Context Information to Be Used in the SNMP v. 3 Protocol

(1) Specify the context information to be used in the SNMP v. 3 protocol.

- ❖ If You Want to Register Context Information
- ❖ If You Want to Erase Context Information

If You Want to Register Context Information

1. Enter the context names used by the SNMPv3 protocol in [Context Name 1] to [Context Name 5] under [Context Settings]. Up to 32 characters can be entered.

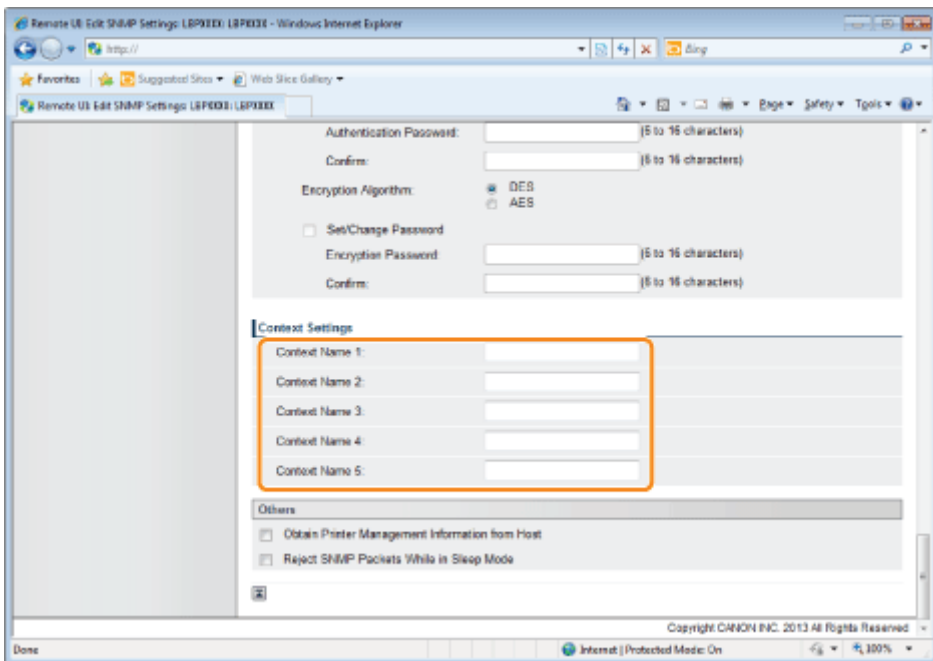

If You Want to Erase Context Information

1. Delete the context names that are entered in [Context Name 1] to [Context Name 5] under [Context Settings] that you want to delete.

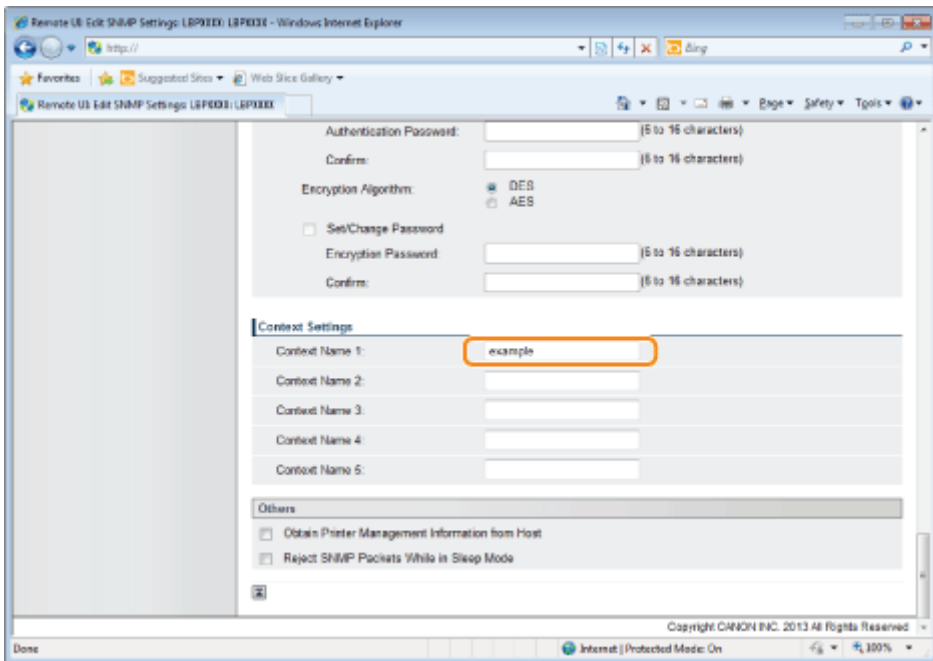

(2) Proceed to Step 7.

7

Click [OK].

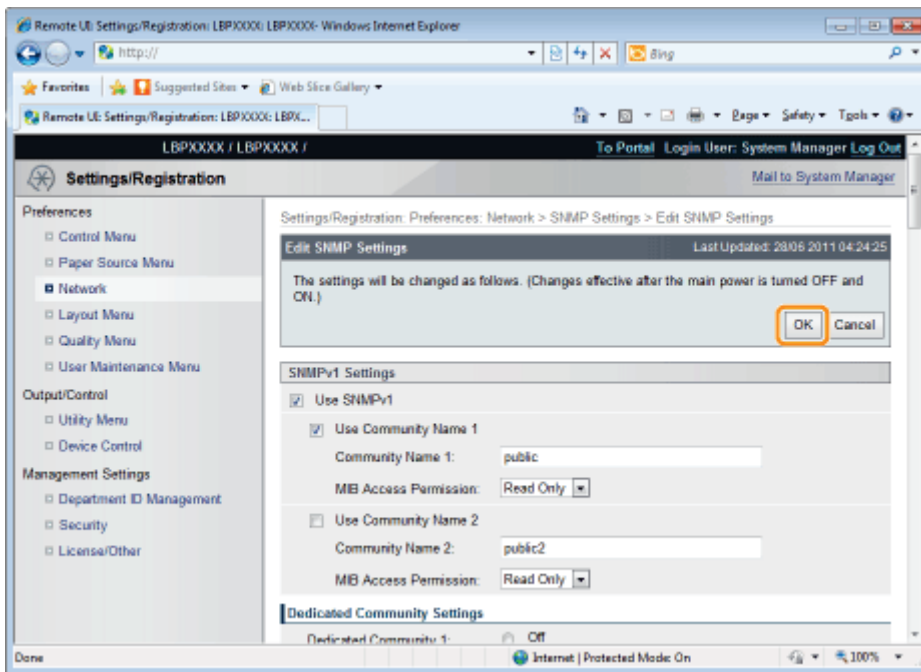

8

Perform a hard reset or restart the printer.

→ After performing a hard reset or restarting the printer, the settings are effective.

NOTE

To perform a hard reset

You can perform a hard reset using the following procedure.

1. Click [Settings/Registration].
2. Select [Device Control] from the [Output/Control] menu.
3. Select [Hard Reset], and then click [Execute].

Setting IEEE802.1X Authentication

04L9-084

Specify the settings for using IEEE802.1X authentication with the printer.

See the following sections according to the protocol to be used for authentication.

- ["Setting TLS Authentication Information"](#)
- ["Setting TTLS/PEAP Authentication Information"](#)

IMPORTANT

Conditions for Using IEEE802.1X Authentication

In order to use IEEE802.1X authentication, an authentication server (RADIUS server) is required.

NOTE

IEEE802.1X Authentication Protocol

- The printer supports TLS, TTLS and PEAP IEEE802.1X authentication.
TLS performs mutual authentication using the certificate sent from the authentication server and the certificate set in the printer.
TTLS and PEAP perform mutual authentication using the certificate sent from the authentication server and the user name and password set in the printer.

Note the following when simultaneously specifying multiple options from TLS, TTLS, and PEAP:

- To select TLS: TTLS or PEAP cannot be specified.
- To select TTLS: TLS cannot be specified. PEAP can be specified.
- To select PEAP: TLS cannot be specified. TTLS can be specified.

The network authentication method to use is determined by the configuration of the authentication server in use. Choose the method based on the configuration of the authentication server

IEEE802.1X Authentication Settings

- We recommend that network settings be performed by the network administrator.

Setting TLS Authentication Information

04L9-085

Set authentication information for using TLS with the IEEE802.1X authentication method.

TLS performs mutual authentication using the authentication server's certificate and the printer's certificate.

IMPORTANT

In order to set up TLS authentication

You need to register a key and certificate or a CA certificate used for authentication to the printer in advance.

- "Setting Keys and Certificates"
- "Setting CA Certificates"

1

Start the Remote UI, and then log in as Administrator.

- "Starting the Remote UI"

2

Click [Settings/Registration].

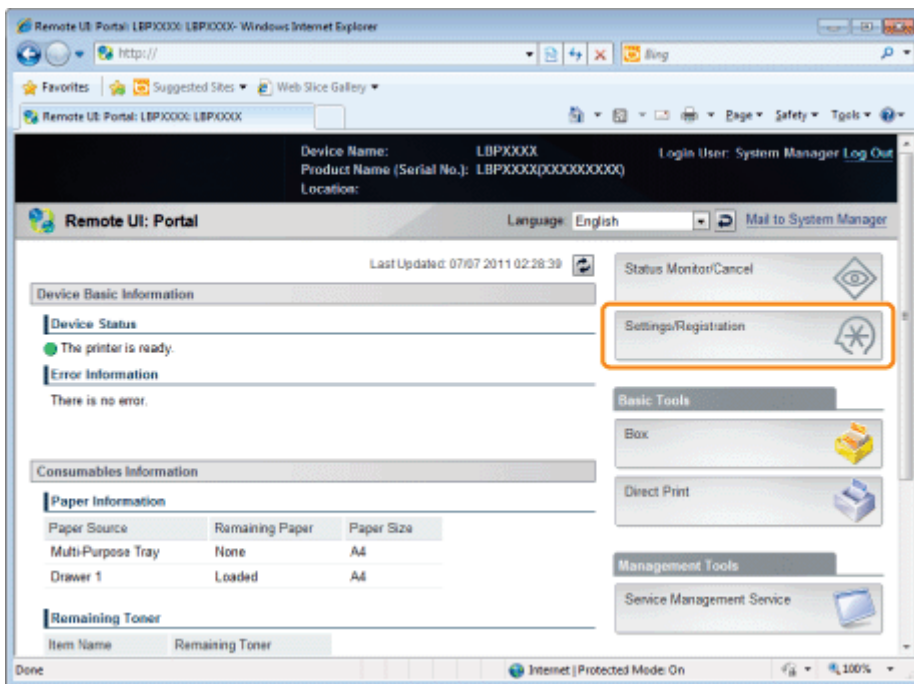

3

Select [Network] from the [Preferences] menu.

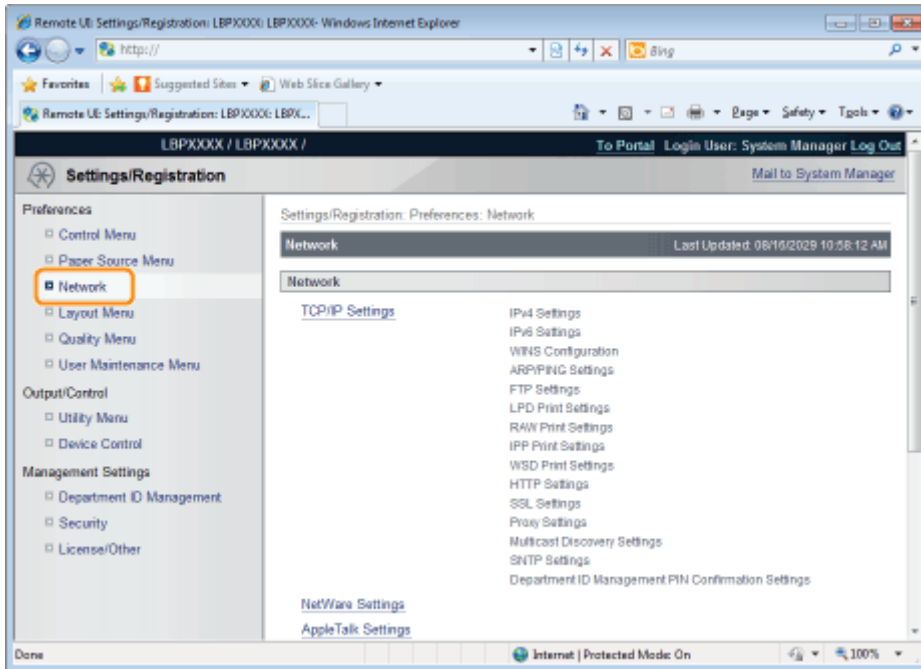

4

Click [IEEE802.1X Settings].

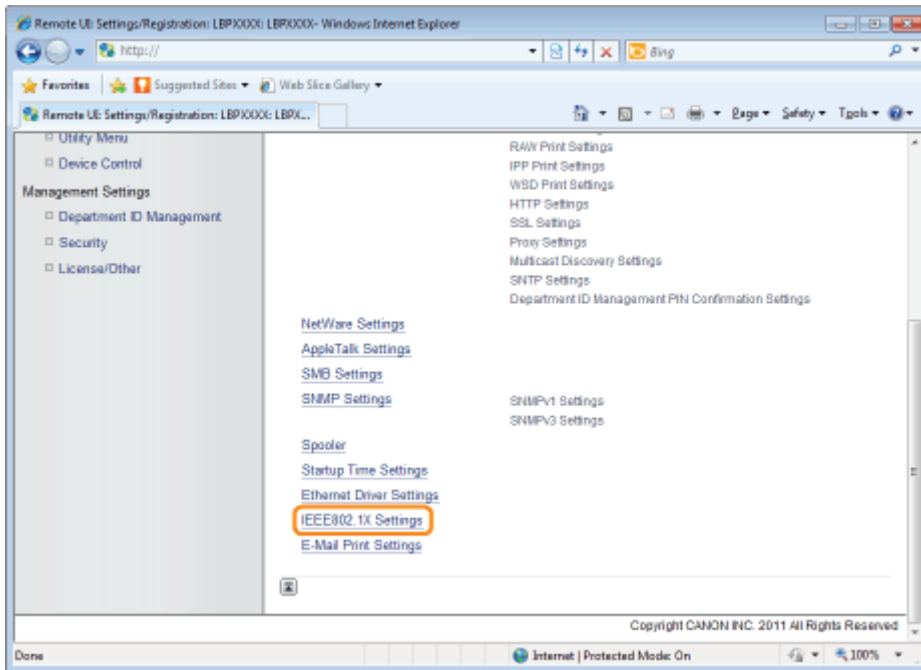

5

Click [Edit...].

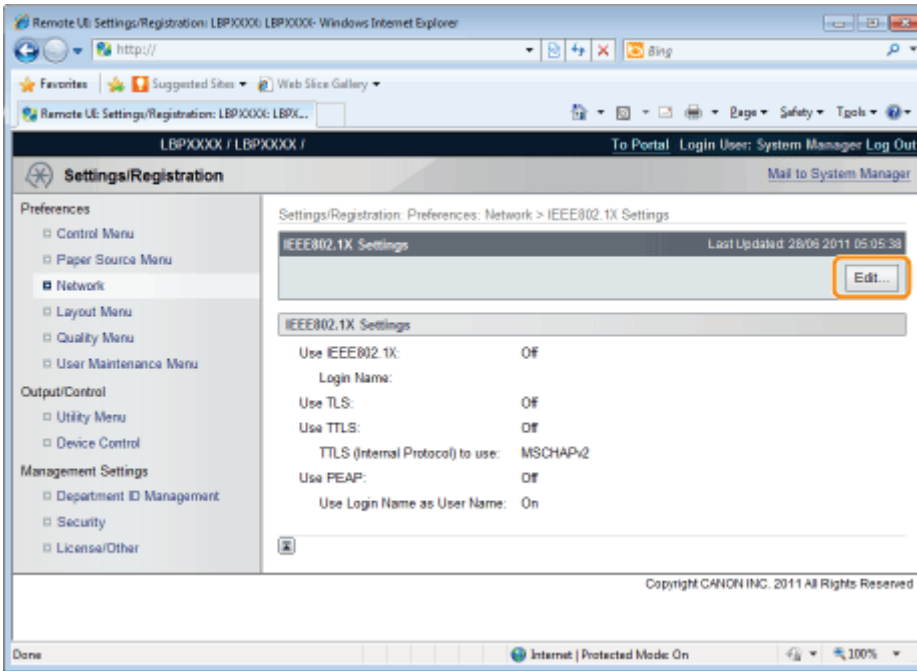

6

Enter the login name.

Up to 24 alphanumeric characters can be entered.

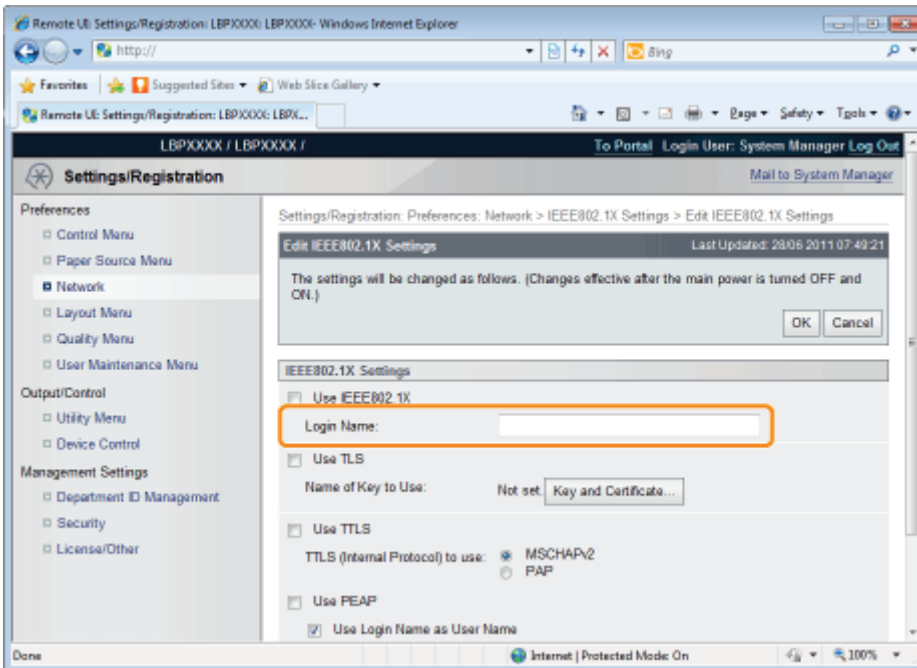

7

Select the [Use TLS] check box.

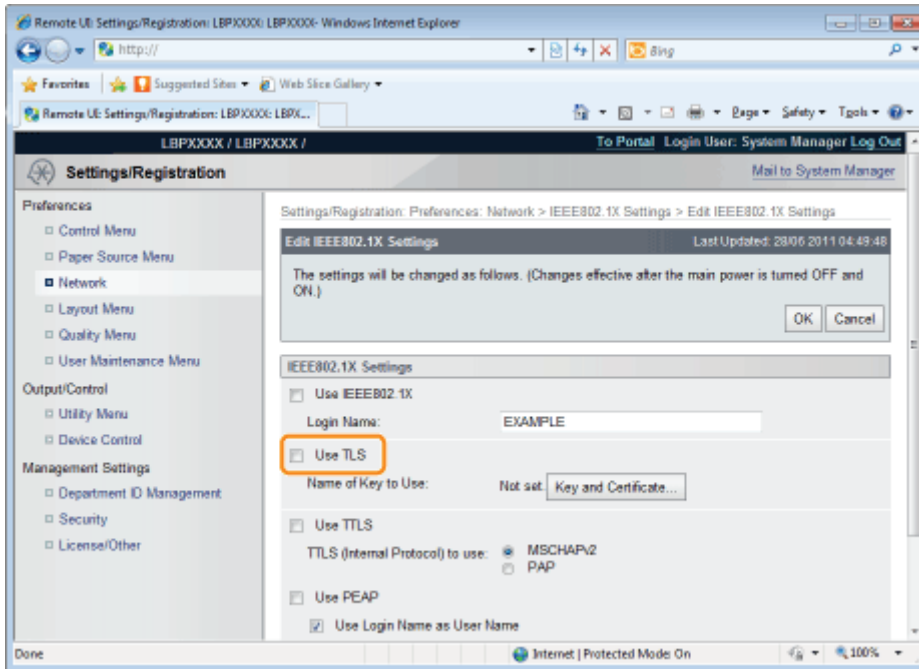

8

Click [Key and Certificate...].

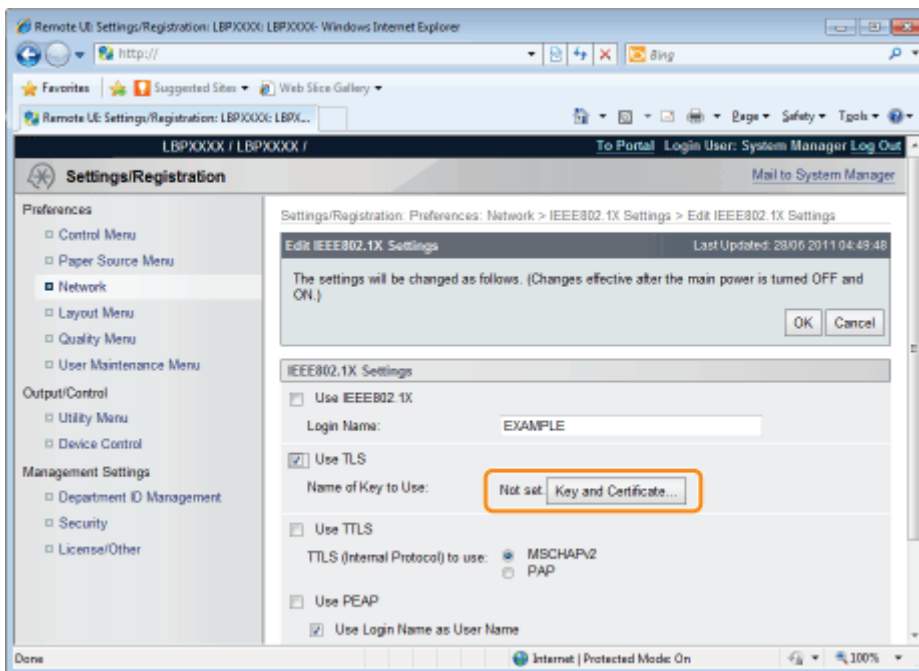

9

Select the key to use, and then click [Default Key Settings].

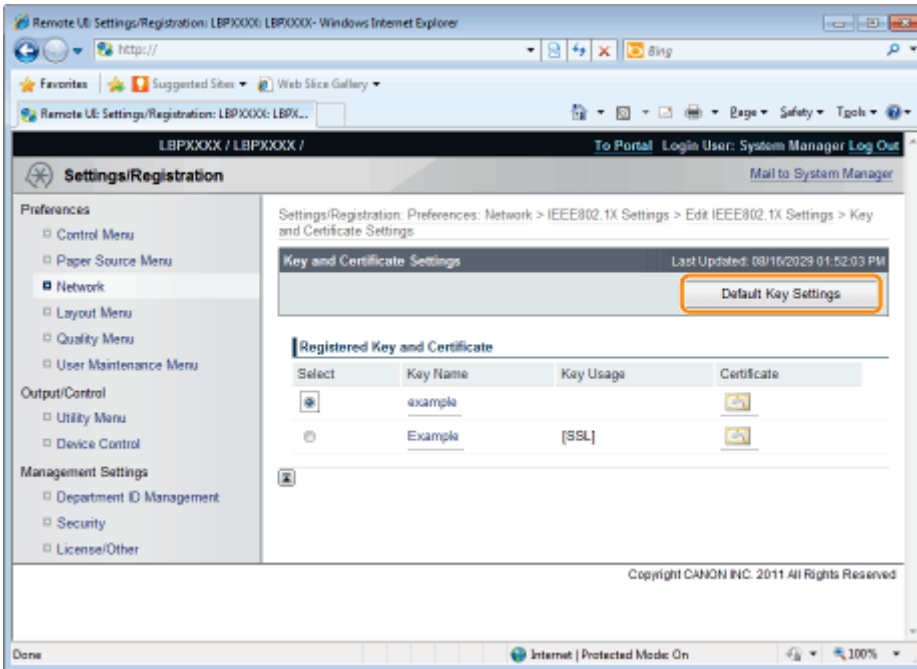

10

Select the [Use IEEE802.1X] check box.

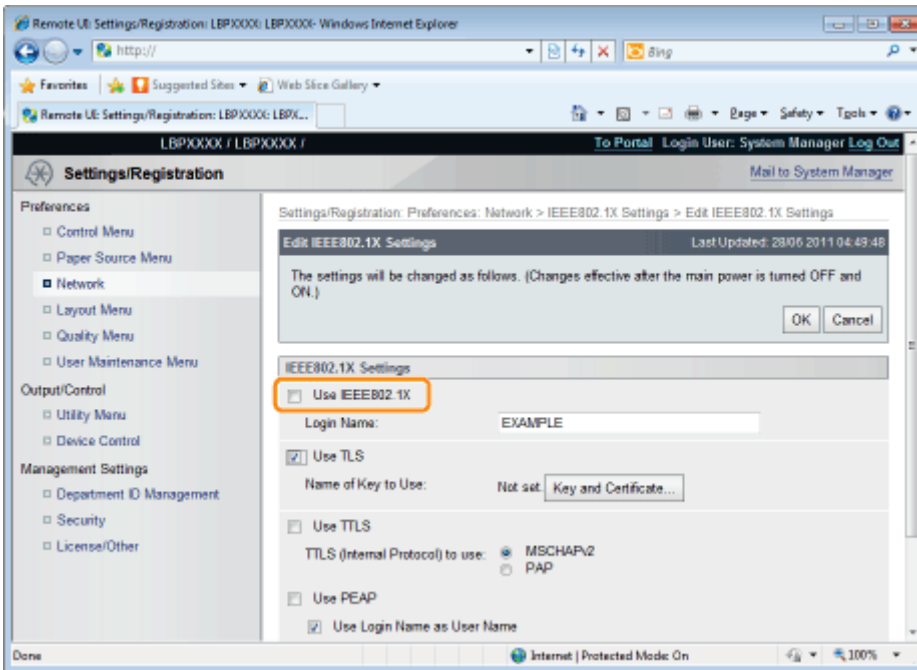

If a Message Appears

A message will be displayed if there is anything wrong with the settings. See Steps 6 to 9, and check the settings.

11

Click [OK].

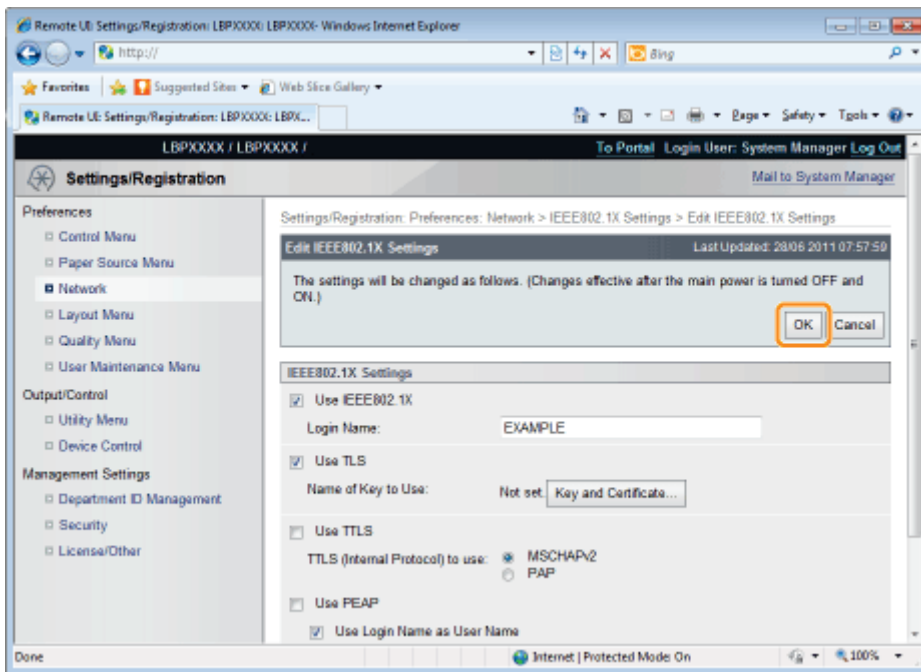

12

Perform a hard reset or restart the printer.

Perform a hard reset or restart the printer.

→ After performing a hard reset or restarting the printer, the settings are effective.

NOTE

To perform a hard reset

You can perform a hard reset using the following procedure.

1. Click [Settings/Registration].
2. Select [Device Control] from the [Output/Control] menu.
3. Select [Hard Reset], and then click [Execute].

Setting TTLS/PEAP Authentication Information

04L9-086

Set authentication information for using TTLS or PEAP with IEEE802.1X authentication.

TTLS and PEAP perform mutual authentication using the authentication server's certificate and the user name and password set in the printer.

IMPORTANT

In order to set a user name and password

You need to set up the SSL encryption communication function in advance.

[Setting the SSL Encryption Communication Function](#)

1

Start the Remote UI, and then log in as Administrator.

[Starting the Remote UI](#)

2

Click [Settings/Registration].

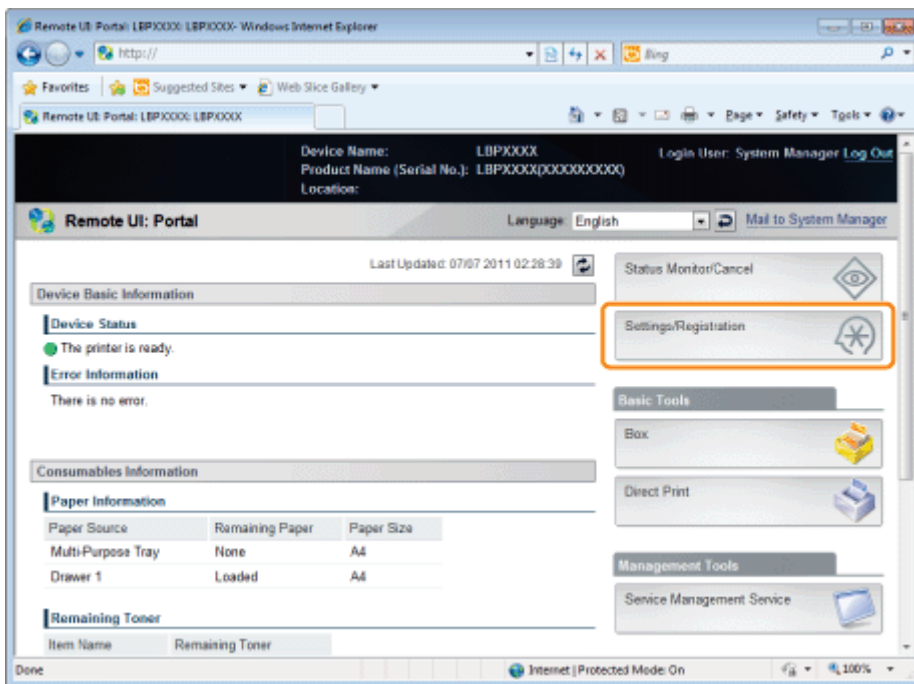

3

Select [Network] from the [Preferences] menu.

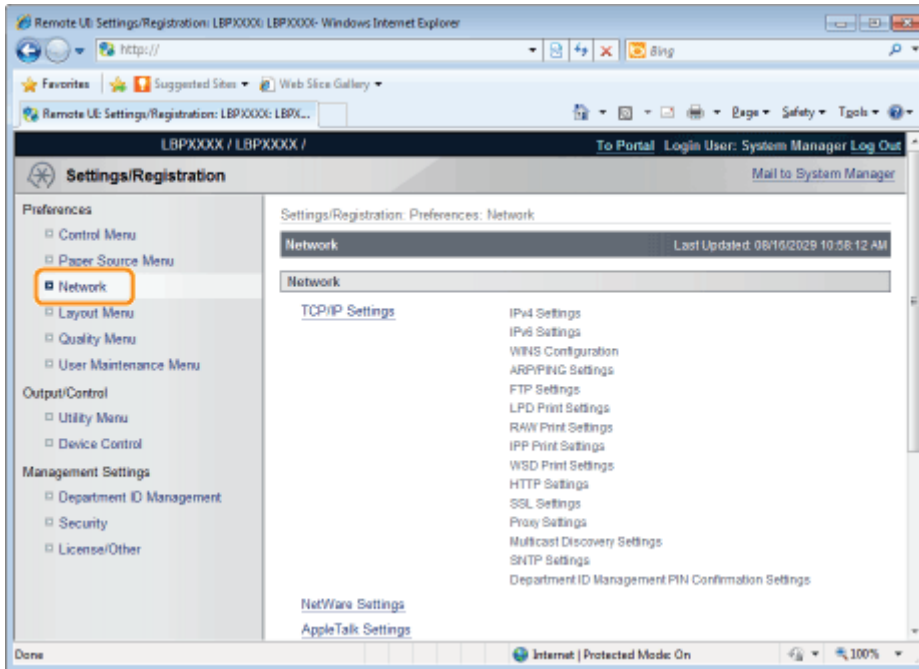

4

Click [IEEE802.1X Settings].

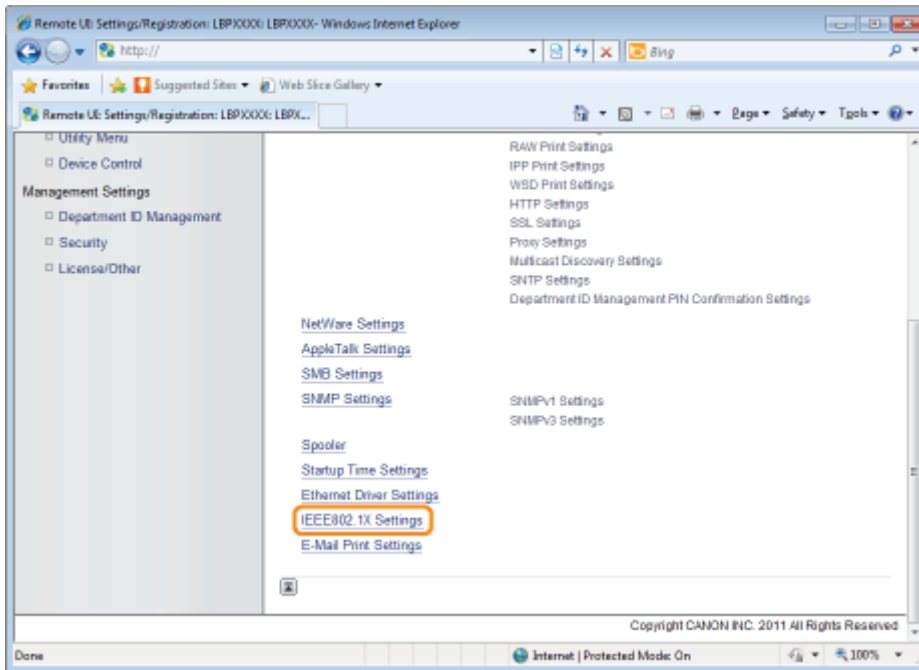

5

Click [Edit...].

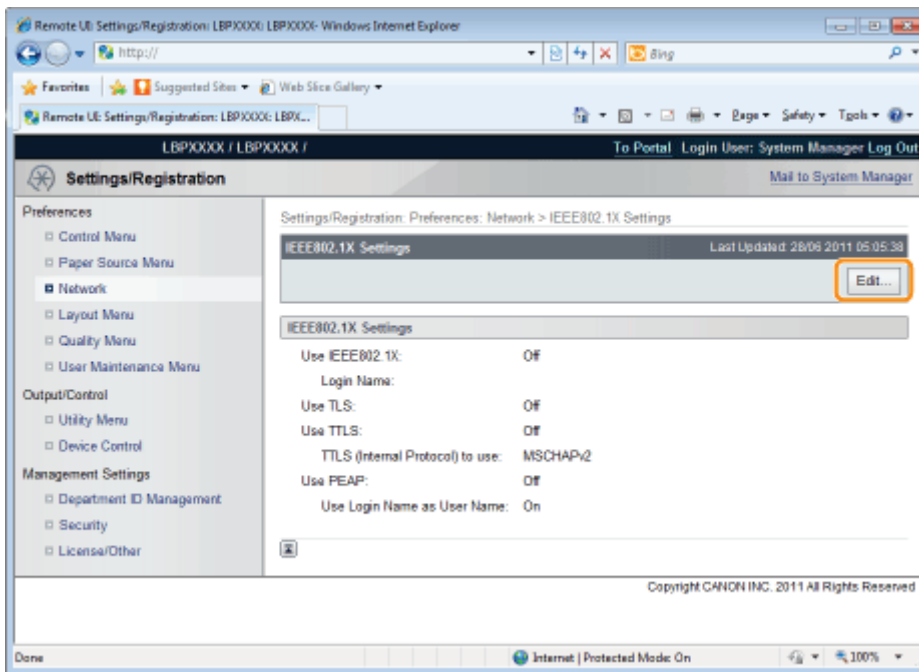

6

Enter the login name.

Up to 24 alphanumeric characters can be entered.

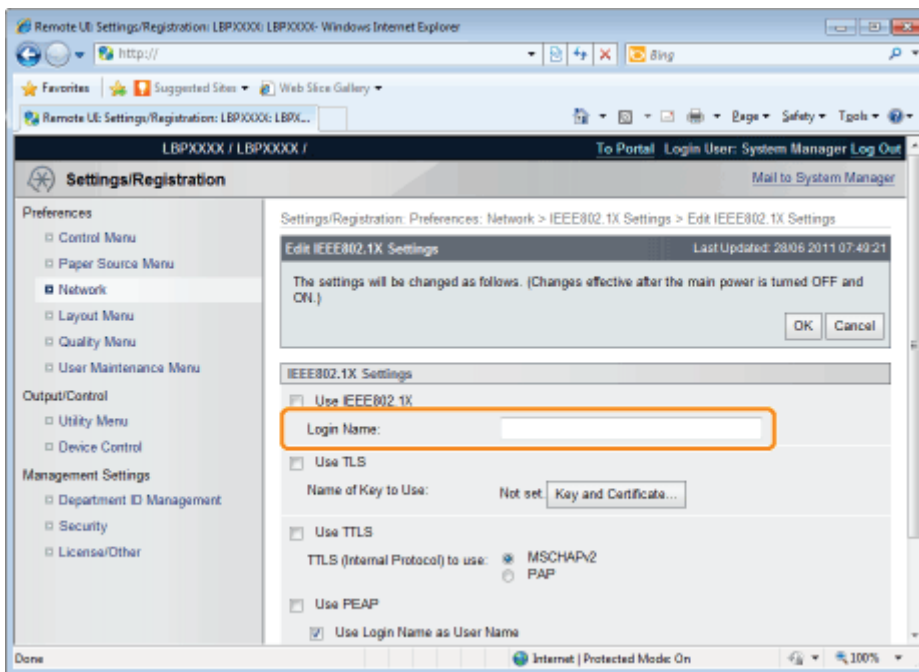

7

Select the [Use TTLS] or [Use PEAP] check box.

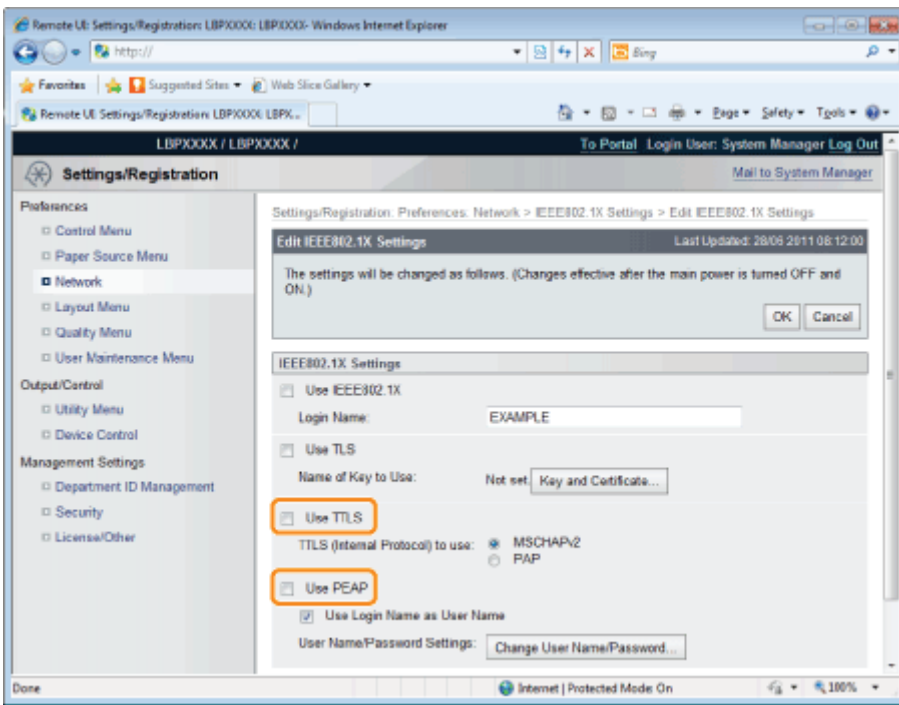

When using TTLS

Select the internal TTLS authentication method.

- (1) Select [MSCHAPv2] or [PAP].

8

Click [Change User Name/Password...].

When using the log in name entered in Step 6 as the user name

Select the [Use Login Name as User Name] check box.

9

Enter user name.

Up to 24 alphanumeric characters can be entered.

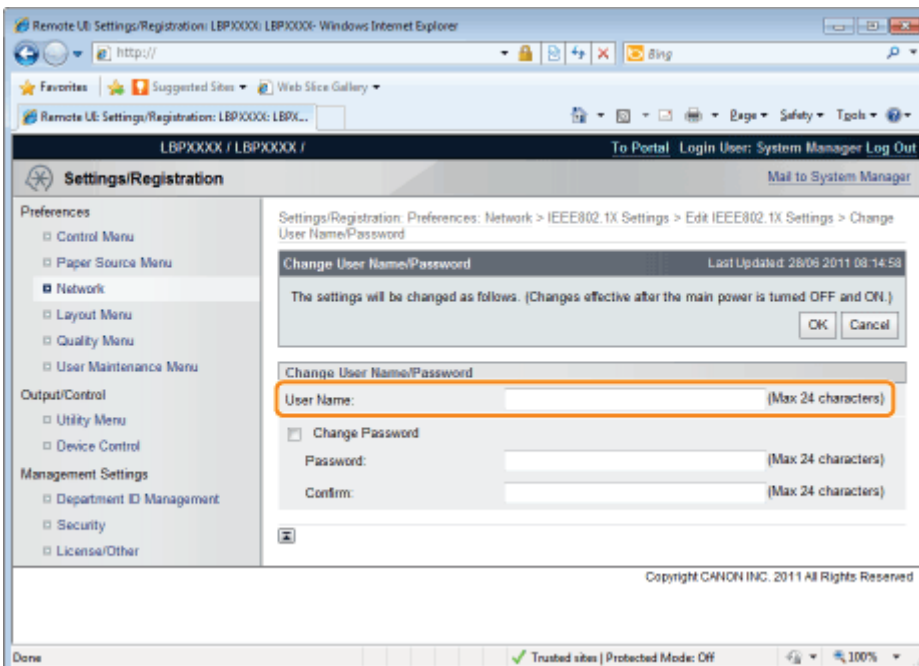

10

Enter password.

- (1) Select the [Change Password] check box.
- (2) Enter password.
You can enter up to 24 characters.
- (3) Enter the same password in the [Confirm] field.
- (4) Click [OK].

11

Select the [Use IEEE802.1X] check box.

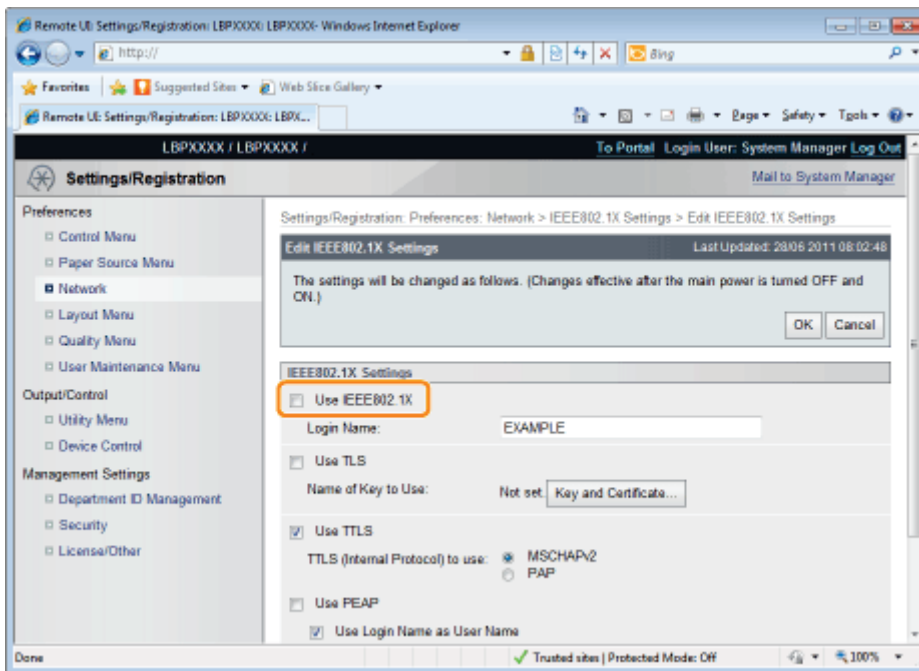

? If a Message Appears

A message will be displayed if there is anything wrong with the settings. See Steps 6 to 10, and check the settings.

12

Click [OK].

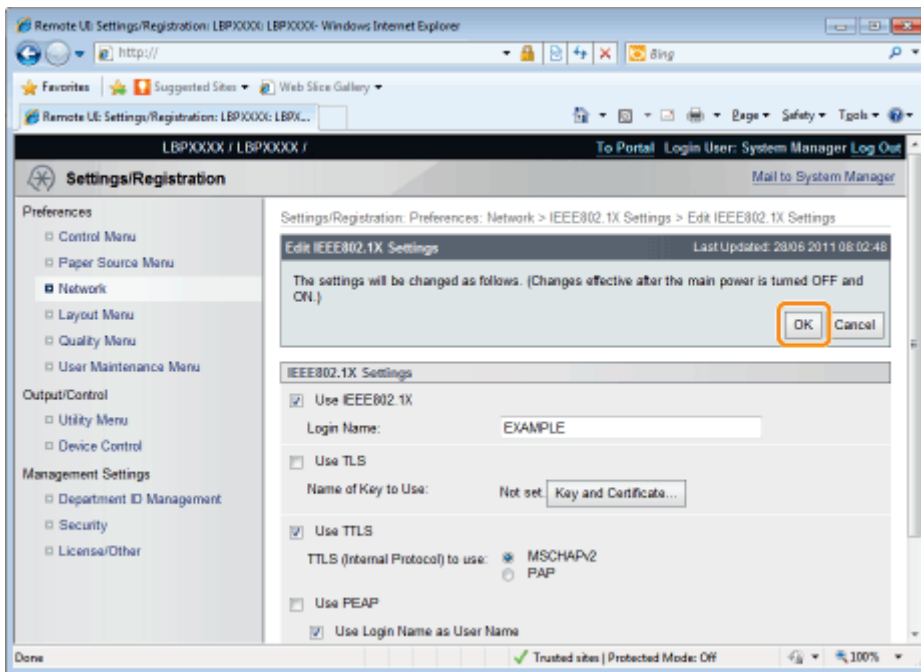

13

Perform a hard reset or restart the printer.

→ After performing a hard reset or restarting the printer, the settings are effective.

NOTE

To perform a hard reset

You can perform a hard reset using the following procedure.

1. Click [Settings/Registration].
2. Select [Device Control] from the [Output/Control] menu.
3. Select [Hard Reset], and then click [Execute].

Network Setting Items

04L9-087

You can change the network settings using various methods.

- ❖ Network Setting Items
- ❖ Software That Can Be Used for the Network Settings

Network Setting Items

The setting items you can change using NetSpot Device Installer, FTP Client, or the control panel on the printer are as follows.

NOTE

The settings that you cannot specify using FTP Client, NetSpot Device Installer, or the control panel on the printer

Specify them using a Web browser (Remote UI).

(However, you cannot specify the settings with ↑ even using the Remote UI.)

About the item names

In the following table, the characters shown in parentheses are exclusively for FTP Client.

For example, "[IP Address] (INT_ADDR)" is displayed differently as follows, depending on the application.

- Web browser (Remote UI): [IP Address]
- NetSpot Device Installer: [IP Address]
- config file of FTP Client: [INT_ADDR]
- Control Panel: [IP Address]

General Settings

: Can be specified : Cannot be specified

Option	Contents	Default	Settings Using NetSpot Device Installer	Settings Using FTP Client	Settings Using the Control Panel
[System Manager Password] (ROOT_PWD)	Up to 16 characters	(Blank)	<input type="radio"/>	<input type="radio"/>	<input type="checkbox"/>
[System Manager] (SYS_CONTACT)	Up to 32 characters	(Blank)	<input type="radio"/>	<input type="radio"/>	<input type="checkbox"/>
[Device Name] (DEVICE_NAME)	Up to 32 characters	LBP6680/LBP6670	<input type="radio"/>	<input type="radio"/>	<input type="checkbox"/>
[Location] (SYS_LOC)	Up to 32 characters	(Blank)	<input type="radio"/>	<input type="radio"/>	<input type="checkbox"/>
[Permit End-User's Job Operation] (USER_JOB_CONT)	ON, OFF	OFF	<input type="checkbox"/>	<input type="radio"/>	<input type="checkbox"/>
Support Link					
[URL] (LINK_URL1)	Up to 128 alphanumeric characters	http://www.canon.com	<input type="checkbox"/>	<input type="radio"/>	<input type="checkbox"/>

TCP/IP (IP v. 4) Settings

○ : Can be specified — : Cannot be specified

Option	Contents	Default	Settings Using NetSpot Device Installer	Settings Using FTP Client	Settings Using the Control Panel
[Use IPv4] (IPV4_USE)	ON, OFF	ON	—	○	○
[DHCP] (DHCP_ENB)	ON, OFF	OFF	○	○	○
[RARP] (RARP_ENB)	ON, OFF	OFF	○	○	○
[BOOTP] (BOOTP_ENB)	ON, OFF	OFF	○	○	○
[IP Address] (INT_ADDR)	IP address	0.0.0.0	○	○	○
[Subnet Mask] (NET_MASK)	IP address	0.0.0.0	○	○	○
[Gateway Address] (DEF_GW)	IP address	0.0.0.0	○	○	○
[Primary DNS Server Address] (DNS_PADDR)	IP address	0.0.0.0	—	○	○
[Secondary DNS Server Address] (DNS_SADDR)	IP address	0.0.0.0	—	○	○
[Host Name] (HOST_NAME)	Up to 47 alphanumeric characters	"Canon" + "Last 6 digits of the MAC address"	—	○	—
[Domain Name] (DOMAIN_NAME)	Up to 47 alphanumeric characters	(Blank)	—	○	—
[DNS Dynamic Update] (DDNS_ENB)	ON, OFF	OFF	—	○	—
[WINS Resolution] (WINS_ENB)	ON, OFF	OFF	—	○	○
[WINS Server Address] (WINS_SERVER)	IP address	0.0.0.0	—	○	—
[Scope ID] (WINS_SCOPEID)	Up to 63 alphanumeric characters	(Blank)	—	○	—
[SMB Server Name] (SMB_SERVER)	Up to 15 alphanumeric characters	(Blank)	—	○	—
[SMB Workgroup Name] (SMB_WG)	Up to 15 alphanumeric characters	(Blank)	—	○	—
[Use ARP/PING] (ARP_PING_ENB)	ON, OFF	ON	—	○	○
[Use FTP Print] (FTP_PRINT_ENB)	ON, OFF	OFF	—	○	○
[FTP Print User Name] (FTP_PRINT_USER)	Up to 24 alphanumeric characters	(Blank)	—	○	—
[Password] (FTP_PRINT_PWD)	Up to 24 alphanumeric characters	(Blank)	—	○	—
[FTP Settings]	ON, OFF	OFF	—	—	○
[Use LPD Printing] (LPD_ENB)	ON, OFF	ON	—	○	○

[Print LPD Banner Page] (LPD_BANN)	ON, OFF	OFF	—	○	—
[Use RAW Printing] (RAW_ENB)	ON, OFF	ON	—	○	○
[Use Bidirectional Communication] (RAW_BIDIR_ENB)	ON, OFF	OFF	—	○	—
[Use IPP Print] (IPP_ENB)	ON, OFF	OFF	—	○	○
[SSL]	ON, OFF (Fixed at OFF when a key is not registered.)	OFF	—	—	○
[IPP Authentication] (IPP_AUTH_ENB)	ON, OFF	ON	—	○	—
[User Name] (IPP_AUTH_ACCUNT1)	Up to 24 characters (Must be entered when using IPP Authentication)	(Blank)	—	○	—
[Password] (IPP_AUTH_PASSWD1)	Up to 24 characters (Must be entered when using IPP Authentication)	(Blank)	—	○	—
[Use WSD Printing] (WSD_ENB)	ON, OFF	OFF	—	○	○
[Use WSD Browsing] (WSD_BROWSING)	ON, OFF	OFF	—	○	○
[Use Multicast Discovery] (WSD_MULTICAST_DISCOVERY)	ON, OFF	OFF	—	○	○
[Use HTTP] (HTTP_ENB)	ON, OFF	ON	—	○	○
[Use Proxy]	ON, OFF	OFF	—	—	○
[HTTP Proxy Server Address]	Up to 128 alphanumeric characters	(Blank)	—	—	○
[HTTP Proxy Server Port Number]	0 to 99999	80	—	—	○
[Use Proxy Within Same Domain]	ON, OFF	OFF	—	—	○
[Proxy Authentication]	ON, OFF	OFF	—	—	○
[User Name]	Up to 24 alphanumeric characters	(Blank)	—	—	○
[Password]	Up to 24 alphanumeric characters	(Blank)	—	—	○
[Discovery Response] (DISCOVERY_ENB)	ON, OFF	ON	—	○	○
[Scope Name] (DISCOVERY_SCOPE_NAME)	Scope name to be used for discovery using utility software such as NetSpot Device Installer. (Up to 32 characters *)	default	—	○	—
[Use SNTP] (SNTP_ENB)	ON, OFF	OFF	—	○	○
[NTP Server Name] (SNTP_ADDR)	IP address or host name	(Blank)	—	○	—
[Polling Interval] (SNTP_INTERVAL)	Interval for synchronizing time (1 to 48 hours)	24	—	○	—

* You cannot use any of the following characters: "(", ")", ":", "!", "<", ">", "=", "~", ";", "+", "*", "\."

TCP/IP (IP v. 6) Settings

: Can be specified : Cannot be specified

Option	Contents	Default	Settings Using NetSpot Device Installer	Settings Using FTP Client	Settings Using the Control Panel
[Use IPv6] (IPV6_USE)	ON, OFF	OFF	<input type="checkbox"/>	<input type="radio"/>	<input type="radio"/>
[Use Stateless Address] (IPV6_STATELESS_USE)	ON, OFF	ON	<input type="checkbox"/>	<input type="radio"/>	<input type="checkbox"/>
[Use Manual Address] (IPV6_MANUAL_ADDR_USE)	ON, OFF	OFF	<input type="checkbox"/>	<input type="radio"/>	<input type="checkbox"/>
[IP Address] (IPV6_MANUAL_ADDR_SET)	IP address	(Blank)	<input type="checkbox"/>	<input type="radio"/>	<input type="checkbox"/>
[Prefix Length] (IPV6_MANUAL_ADDR_PREFIX)	0 to 128	64	<input type="checkbox"/>	<input type="radio"/>	<input type="checkbox"/>
[Default Router Address] (IPV6_MANUAL_ROUTER_ADDR)	IP address	(Blank)	<input type="checkbox"/>	<input type="radio"/>	<input type="checkbox"/>
[Use DHCPv6] (IPV6_DHCPV6_USE)	ON, OFF	OFF	<input type="checkbox"/>	<input type="radio"/>	<input type="checkbox"/>
[Primary DNS Server Address] (IPV6_DNS_ADDRESS_PRI)	IP address	(Blank)	<input type="checkbox"/>	<input type="radio"/>	<input type="checkbox"/>
[Secondary DNS Server Address] (IPV6_DNS_ADDRESS_SEC)	IP address	(Blank)	<input type="checkbox"/>	<input type="radio"/>	<input type="checkbox"/>
[Use IPv4 Host/Domain Names] (IPV6_DNS_NAME_SAME_AS_IPV4)	ON, OFF	OFF	<input type="checkbox"/>	<input type="radio"/>	<input type="checkbox"/>
[Host Name] (IPV6_DNS_HOST_NAME_V6)	Up to 47 alphanumeric characters	"Canon" + "Last 6 digits of the MAC address"	<input type="checkbox"/>	<input type="radio"/>	<input type="checkbox"/>
[Domain Name] (IPV6_DNS_DOMAIN_NAME_V6)	Up to 47 alphanumeric characters	(Blank)	<input type="checkbox"/>	<input type="radio"/>	<input type="checkbox"/>
[DNS Dynamic Update] (IPV6_DNS_DYNAMIC_SET)	ON, OFF	OFF	<input type="checkbox"/>	<input type="radio"/>	<input type="checkbox"/>
[Register Manual Address] (IPV6_DNS_MANUAL)	ON, OFF	OFF	<input type="checkbox"/>	<input type="radio"/>	<input type="checkbox"/>
[Register Stateful Address] (IPV6_DNS_STATEFUL)	ON, OFF	OFF	<input type="checkbox"/>	<input type="radio"/>	<input type="checkbox"/>
[Register Stateless Address] (IPV6_DNS_STATELESS)	ON, OFF	OFF	<input type="checkbox"/>	<input type="radio"/>	<input type="checkbox"/>

NetWare Network Settings

: Can be specified : Cannot be specified

Option	Contents	Default	Settings Using NetSpot Device Installer	Settings Using FTP Client	Settings Using the Control Panel
[Use NetWare] (NW_ENB)	ON, OFF	OFF	<input type="radio"/>	<input type="radio"/>	<input type="radio"/>

[Frame Type] (NW_FRAME_TYPE)	Frame type used by NetWare	AutoSense ([Auto Detect])	<input type="radio"/>	<input type="radio"/>	<input type="radio"/>
[IPX External Network Number]	(Display only)	—	—	—	—
[Node Number]	(Display only)	—	—	—	—
[Print Service] (NW_PRINT_SERVICE)	Print service to be used	ndsPserver([NDS PServer])	<input type="radio"/>	<input type="radio"/>	<input type="radio"/>
Bindery PServer					
[File Server Name] (NW_PSERVER_FILE_SERVER_NAME)	Name of the NetWare file server to which the NetWare print server belongs (1 to 47 characters)	(Blank)	<input type="radio"/>	<input type="radio"/>	—
[Print Server Name] (NW_PSERVER_PRINT_SERVER_NAME)	NetWare print server name to be used (1 to 47 characters)	(Blank)	<input type="radio"/>	<input type="radio"/>	—
[Print Server Password] (NW_PSERVER_PASSWD)	Password for accessing the print server (0 to 20 characters)	(Blank)	<input type="radio"/>	<input type="radio"/>	—
[Printer Number] (NW_PSERVER_PRINTER_NO)	Number for the printer connected to the NetWare print server (0 to 15)	0	<input type="radio"/>	<input type="radio"/>	—
[Service Mode] (NW_PSERVER_SERVICE_MODE)	Service mode to be used psMode1: Only the currently loaded paper can be serviced. psMode2: Paper can be changed as needed. psMode3: The order of the jobs is rearranged to minimize the frequency of changing paper. psMode4: The order of the jobs in a queue is rearranged to minimize the frequency of changing paper.	psMode4	<input type="radio"/>	<input type="radio"/>	—
[Printer Form] (NW_PSERVER_PRINTER_FORM)	Paper Define Form (0 to 255)	0	<input type="radio"/>	<input type="radio"/>	—

[Polling Interval] (NW_PSERVER_POLLING_INT)	Interval for checking the jobs (1 to 15 seconds)	5	<input type="radio"/>	<input type="radio"/>	—
[Buffer Size] (NW_PSERVER_BUFFER_SIZE)	Data Buffer Size (1 to 20 KB)	20	<input type="radio"/>	<input type="radio"/>	—
NDS PServer					
[Tree Name] (NW_NDSSERVER_TREE_NAME)	Name of the NDS tree to which the NetWare print server belongs (1 to 32 characters)	(Blank)	<input type="radio"/>	<input type="radio"/>	—
[Context Name] (NW_NDSSERVER_CONTEXT_NAME)	Name of the context to which the NetWare print server belongs (1 to 255 characters)	(Blank)	<input type="radio"/>	<input type="radio"/>	—
[Print Server Name] (NW_NDSSERVER_PRINT_SERVER_NAME)	NetWare print server name to be used (1 to 64 characters)	(Blank)	<input type="radio"/>	<input type="radio"/>	—
[Print Server Password] (NW_NDSSERVER_PRINT_SERVER_PASSWORD)	Password for accessing the print server (0 to 20 characters)	(Blank)	<input type="radio"/>	<input type="radio"/>	—
[Printer Number] (NW_NDSSERVER_PRINTER_NO)	Number for the printer connected to the NetWare print server (0 to 254)	0	<input type="radio"/>	<input type="radio"/>	—
[Service Mode] (NW_NDSSERVER_SERVICE_MODE)	Service mode to be used psMode1: Only the currently loaded paper can be serviced. psMode2: Paper can be changed as needed. psMode3: The order of the jobs is rearranged to minimize the frequency of changing paper. psMode4: The order of the jobs in a queue is rearranged to minimize the	psMode4	<input type="radio"/>	<input type="radio"/>	—

	frequency of changing paper.				
[Printer Form] (NW_NDSSERVER_PRINTER_FORM)	Paper Define Form (0 to 255)	0	<input type="radio"/>	<input type="radio"/>	—
[Polling Interval] (NW_NDSSERVER_POLLING_INT)	Interval for checking the jobs (1 to 255 seconds)	5	<input type="radio"/>	<input type="radio"/>	—
[Buffer Size] (NW_NDSSERVER_BUFFER_SIZE)	Data Buffer Size (3 to 20 KB)	20	<input type="radio"/>	<input type="radio"/>	—
RPrinter					
[File Server Name] (NW_RPRINTER_FILE_SERVER_NAME)	Name of the NetWare file server to which the NetWare print server belongs (1 to 47 characters)	(Blank)	<input type="radio"/>	<input type="radio"/>	—
[Print Server Name] (NW_RPRINTER_PRINT_SERVER_NAME)	NetWare print server name to be used (1 to 47 characters)	(Blank)	<input type="radio"/>	<input type="radio"/>	—
[Printer Number] (NW_RPRINTER_PRINTER_NO)	Number for the printer connected to the NetWare print server (0 to 15)	0	<input type="radio"/>	<input type="radio"/>	—
NPrinter					
[Tree Name] (NW_NPRINTER_TREE_NAME)	Name of the NPrinter tree to which the NetWare print server belongs (1 to 32 characters)	(Blank)	<input type="radio"/>	<input type="radio"/>	—
[Context Name] (NW_NPRINTER_CONTEXT_NAME)	Name of the context to which the NetWare print server belongs (1 to 256 characters)	(Blank)	<input type="radio"/>	<input type="radio"/>	—
[Print Server Name] (NW_NPRINTER_PRINT_SERVER_NAME)	NetWare print server name to be used (1 to 64 characters)	(Blank)	<input type="radio"/>	<input type="radio"/>	—
[Printer Number] (NW_NPRINTER_PRINTER_NO)	Number for the printer connected to the NetWare print server (0 to 254)	0	<input type="radio"/>	<input type="radio"/>	—

AppleTalk Settings

: Can be specified — : Cannot be specified

Option	Contents	Default	Settings Using NetSpot Device Installer	Settings Using FTP Client	Settings Using the Control Panel
[Use AppleTalk] (ATLK_ENB)	ON, OFF	OFF	<input type="radio"/>	<input type="radio"/>	<input type="radio"/>
[Phase]†	Fixed at [Phase 2]	[Phase 2]	—	—	—
[Service Name] (APRINT_1)	Up to 32 characters *1	LBP6680x/LBP6670dn	—	<input type="radio"/>	—
[Zone] (ATK_ZONE)	Up to 32 characters *2	*	<input type="radio"/>	<input type="radio"/>	—
[Print Mode]*3	[Open Both Spool and Direct], [Open Spool], [Open Direct]	[Open Both Spool and Direct]	—	—	—

1 "=", "@", "", ":", and "~" cannot be used.

*2 "=", "@", ":", and "~" cannot be used.

*3 Can be specified only when PS ROM is installed.

SMB Settings (LBP6680x Only)

: Can be specified — : Cannot be specified

Option	Contents	Default	Settings Using NetSpot Device Installer	Settings Using FTP Client	Settings Using the Control Panel
[Use SMB Server](SMB_ENB)	ON, OFF	OFF	—	<input type="radio"/>	<input type="radio"/>
[Server Name](SMB_SERVER)	Up to 15 characters *	(Blank)	—	<input type="radio"/>	—
[Workgroup Name](SMB_WG)	Up to 15 characters *	(Blank)	—	<input type="radio"/>	—
[Comments](SMB_COMMENT)	Up to 48 characters	(Blank)	—	<input type="radio"/>	—
[Use LM Announce](SMB_LM_ENB)	ON, OFF	OFF	—	<input type="radio"/>	—
[Use SMB Printing](SMB_PRINT_ENB)	ON, OFF	OFF	—	<input type="radio"/>	<input type="radio"/>
[Printer Name](SMB_PRINTER)	Up to 13 characters *	(Blank)	—	<input type="radio"/>	—

* You cannot enter a space between characters.

SNMP Settings

: Can be specified — : Cannot be specified

Option	Contents	Default	Settings Using NetSpot Device Installer	Settings Using FTP Client	Settings Using the Control Panel
[Use SNMPv1]					

(SNMP_V1_ENB)	ON, OFF	ON	—	<input type="radio"/>	<input type="radio"/>
[Use Community Name 1] (SNMP_COMMUNITY1_ENB)	ON, OFF	ON	—	<input type="radio"/>	<input type="radio"/>
[Community Name 1] (SNMP_COMMUNITY1_NAME)	Up to 32 characters	public	—	<input type="radio"/>	—
[MIB Access Permission] (SNMP_COMMUNITY1_ACCESS)	RW, RO ([Read/Write], [Read Only])	RO ([Read Only])	—	<input type="radio"/>	<input type="radio"/>
[Use Community Name 2] (SNMP_COMMUNITY2_ENB)	ON, OFF	OFF	—	<input type="radio"/>	<input type="radio"/>
[Community Name 2] (SNMP_COMMUNITY2_NAME)	Up to 32 characters	public2	—	<input type="radio"/>	—
[MIB Access Permission] (SNMP_COMMUNITY2_ACCESS)	RW, RO ([Read/Write], [Read Only])	RO ([Read Only])	—	<input type="radio"/>	<input type="radio"/>
[Use SNMPv3] (SNMP_V3_ENB)	ON, OFF	OFF	—	<input type="radio"/>	<input type="radio"/>
[Obtain Printer Management Information from Host] (SNMP_GET_PRT_MNG_INFO)	ON, OFF	OFF	—	<input type="radio"/>	—
[Reject SNMP Packets While in Sleep Mode]	ON, OFF	OFF	—	—	<input type="radio"/>

User Settings (SNMPv3)

: Can be specified — : Cannot be specified

Option	Contents	Default	Settings Using NetSpot Device Installer	Settings Using FTP Client	Settings Using the Control Panel
[User Name]	Up to 32 alphanumeric characters	initial	—	—	—
[MIB Access Permission]	[Read/Write], [Read Only]	[Read/Write]	—	—	—
[Security Settings]	[Authentication Yes/Encryption Yes], [Authentication Yes/Encryption No], [Authentication No/Encryption No]	[Authentication Yes/Encryption Yes]	—	—	—
[Authentication Algorithm]	[MD5], [SHA1]	[MD5]	—	—	—
[Authentication Password] *	6 to 16 alphanumeric characters	initial	—	—	<input type="radio"/>
[Encryption Algorithm]	[DES], [AES]	[DES]	—	—	—
[Encryption Password] *	6 to 16 alphanumeric characters	initial	—	—	<input type="radio"/>

* Can be specified only when the printer is in the state of SSL encrypted communication. (If the printer is not in the state of encrypted communication, specify the setting using the printer's control panel.)

Context Settings (SNMPv3)

: Can be specified — : Cannot be specified

Option	Contents	Default	Settings Using NetSpot Device Installer	Settings Using FTP Client	Settings Using the Control Panel
[Context Name 1] - [Context Name 5]	Up to 32 alphanumeric characters	(Blank)	—	—	—

Spooler Settings (LBP6680x Only)

: Can be specified — : Cannot be specified

Option	Contents	Default	Settings Using NetSpot Device Installer	Settings Using FTP Client	Settings Using the Control Panel
[Use Spooler](SPOOL_ENB)	ON, OFF	OFF	—	<input type="radio"/>	<input type="radio"/>

Startup Time Setting

: Can be specified — : Cannot be specified

Option	Contents	Default	Settings Using NetSpot Device Installer	Settings Using FTP Client	Settings Using the Control Panel
[Startup Time] (STRT_DELAY_TIME)	Waiting time from when you turn the printer ON to when the printer starts obtaining the address (0 to 300 seconds)	0	—	<input type="radio"/>	<input type="radio"/>

Ethernet Driver Setting

: Can be specified — : Cannot be specified

Option	Contents	Default	Settings Using NetSpot Device Installer	Settings Using FTP Client	Settings Using the Control Panel
[Auto Detect]	ON, OFF	ON	—	—	<input type="radio"/>
[Communication Mode]	[Half Duplex], [Full Duplex]	[Half Duplex]	—	—	<input type="radio"/>
[Ethernet Type]	[10 Base-T], [100 Base-TX], [1000 Base-T]	[10 Base-T]	—	—	<input type="radio"/>

E-Mail Print Settings

: Can be specified — : Cannot be specified

Option	Contents	Default	Settings Using NetSpot Device Installer	Settings Using FTP Client	Settings Using the Control Panel
[POP3 Server]	Up to 48 alphanumeric	(Blank)	—	<input type="radio"/>	—

Name](EMAIL_POP_ADDR)	characters				
[POP3 User Name](EMAIL_POP_ACCOUNT)	Up to 32 alphanumeric characters	(Blank)	—	○	—
[Password](EMAIL_POP_PASSWD)	Up to 32 alphanumeric characters	(Blank)	—	○	—
[POP3 RX Interval](EMAIL_POP_INTERVAL)	0 to 90 minutes	0	—	○	○
[POP3 RX](EMAIL_PRINT_ENB)	ON, OFF	OFF	—	○	○
[POP3 Server Port Number](EMAIL_POP_PORTNO)	0 to 65535	110	—	○	—
[SMTP RX]	ON, OFF	OFF	—	—	○
[SMTP Server Port Number]	0 to 65535	25	—	—	—

Remote UI Settings

○ : Can be specified — : Cannot be specified

Option	Contents	Default	Settings Using NetSpot Device Installer	Settings Using FTP Client	Settings Using the Control Panel
[Remote UI](RUI_ENB)*	Turing ON or OFF the Remote UI	ON	—	○	○
[Use SSL]	ON, OFF	OFF	—	—	○

* Can be specified only by FTP Client or the printer's control panel

Permitted Receiving MAC Address Settings

○ : Can be specified — : Cannot be specified

Option	Contents	Default	Settings Using NetSpot Device Installer	Settings Using FTP Client	Settings Using the Control Panel
[MAC Address Filter]	ON, OFF	OFF	—	—	○
[MAC Address]	(Display only)	—	—	—	○

Software That Can Be Used for the Network Settings

You can perform the network settings for this printer using the following software.

○ : Specifiable

— : Not specifiable

△ : Can perform a part of the settings

Setting Type	Web Browser (Remote UI)	FTP Client	NetSpot Device Installer	ARP/PING Command	Control Panel of the Printer
Configuring the Ethernet Driver ⚙️					

"Changing the Network Transmission Speed or Transfer Mode"	○	—	—	—	○
Setting the Spooling Function (LBP6680x only) <ul style="list-style-type: none"> "Setting the Spooling Function (LBP6680x Only)" 	○	○	—	—	○
Configuring the Communication Environment <ul style="list-style-type: none"> "Specifying the Setting for Startup Waiting Time" 	△	△	—	—	○
Setting the IP Address of the Printer <ul style="list-style-type: none"> "Setting the IP Address (IP v. 4)" 	○	—	○	○	○
Setting the TCP/IP Protocol <ul style="list-style-type: none"> "Configuring the Protocol Settings" 	○	○	△	—	△
Setting IP v. 6 <ul style="list-style-type: none"> "Setting IP v. 6" 	○	○	—	△	△
Preparing the NetWare Protocol Settings <ul style="list-style-type: none"> "Configuring NetWare" 	—	—	○	—	—
Setting the NetWare Protocol <ul style="list-style-type: none"> "Configuring the Protocol Settings" 	○	○	△	—	—
Setting the AppleTalk Protocol <ul style="list-style-type: none"> "Network Settings for the Printer (AppleTalk)" 	○	○	△	—	△
Changing the Device Name or Administrator Information <ul style="list-style-type: none"> "Specifying the Device Name or" 	○	○	△	—	—

Administrator Information"					
Changing the Administrator Password <ul style="list-style-type: none"> "Setting the Administrator Password" 	○	○	○	—	—
Specifying the Job Operation Permission for End-users <ul style="list-style-type: none"> "Specifying the Job Operation Permission for End-Users" 	○	○	—	—	—
Restricting the Job Requests by Certain Devices <ul style="list-style-type: none"> "Restricting the Users Who Can Print or Perform the Printer Settings" 	○	—	—	—	○
Setting the Key Lock Function <ul style="list-style-type: none"> "Locking the Keys on the Control Panel (Key Lock Function)" 	○	—	—	—	△
Changing E-Mail Print Settings <ul style="list-style-type: none"> "Receiving E-mail Data on the Mail Server and Printing (E-mail Print)" 	○	○	—	—	△

Initializing the Network Settings

04L9-088

If you want to reset the network settings for the printer to the default values, use the printer's control panel.

"Initializing the Network Settings Using the Printer's Control Panel"

Initialize the network settings using the control panel while checking the display on the printer.

IMPORTANT

Precautions when initializing the network settings

Make sure that the printer is not operating before initializing the network settings.

If you initialize the network settings while the printer is printing or receiving data, the received data may not be printed properly, or may result in paper jams or damage to the printer.

NOTE

When checking the current settings

 ["Checking the Printer Settings"](#)

Initializing the Network Settings Using the Printer's Control Panel

04L9-089

1

Press [] ( : Settings).

2

Select [Network] using [▲] and [▼], and then press [OK].

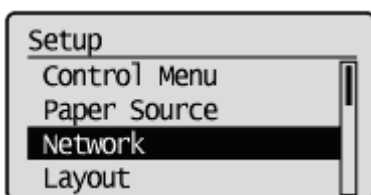

When the message is displayed, press [OK].

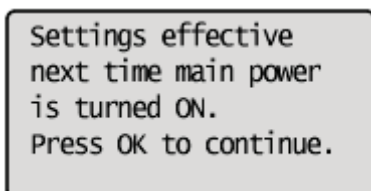

3

Select [Init. Network Set.] using [▲] and [▼], and then press [OK].

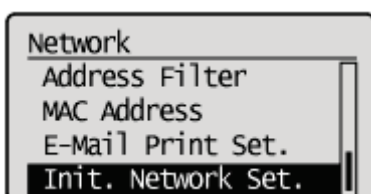

4

Select [Yes] using [▼], and then press [OK].

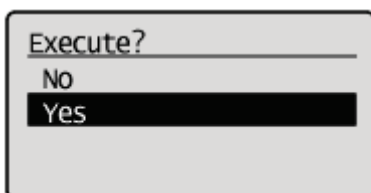

Checking the MAC Address

04L9-08A

You need the MAC address of the printer to set the IP address using NetSpot Device Installer or the ARP/PING command. There are the following three methods for checking MAC addresses.

- ❖ "Checking the Network Ethernet Driver Screen from a Remote UI"
- ❖ "Printing a Network Status Print from the Printer's Control Panel and Checking It"
- ❖ "[Setup] Menu ([Network] Options)"

Checking the Network Ethernet Driver Screen from a Remote UI

1

Start the Remote UI, and then log in as Administrator.

- ❖ "Starting the Remote UI"

2

Click [Settings/Registration].

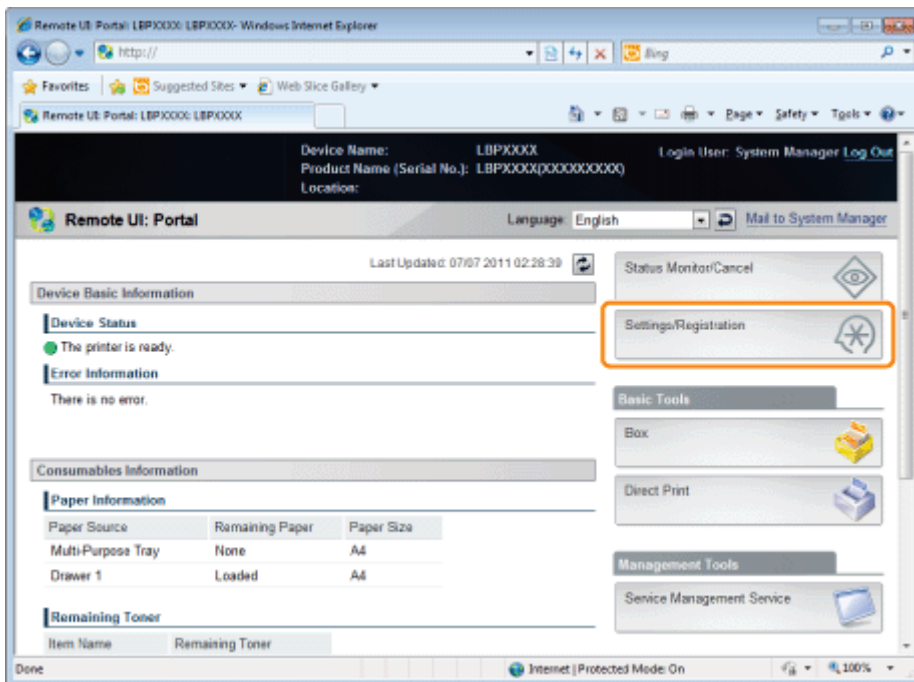

3

Select [Network] from the [Preferences] menu.

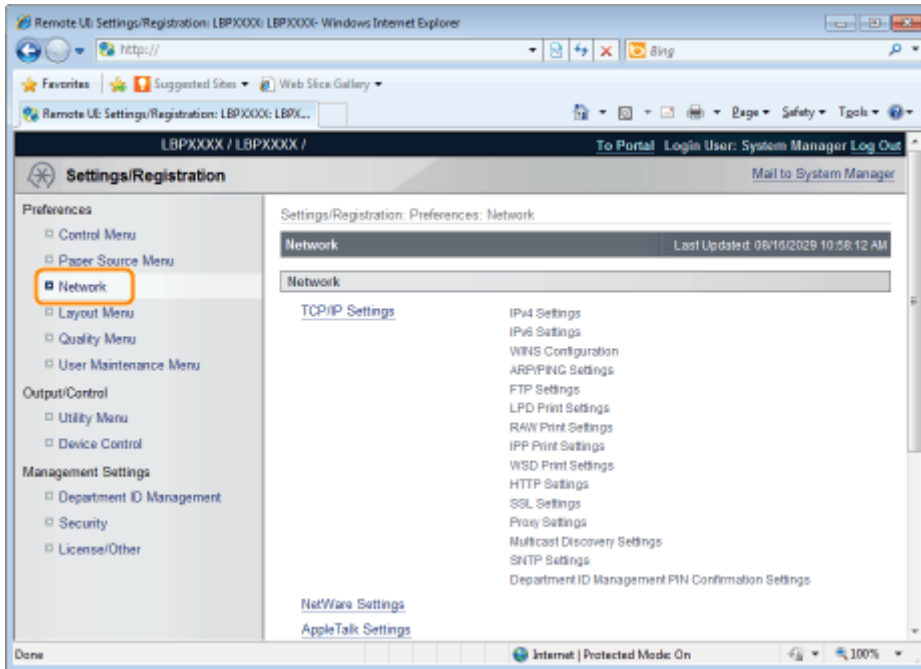

4

Click [Ethernet Driver Settings].

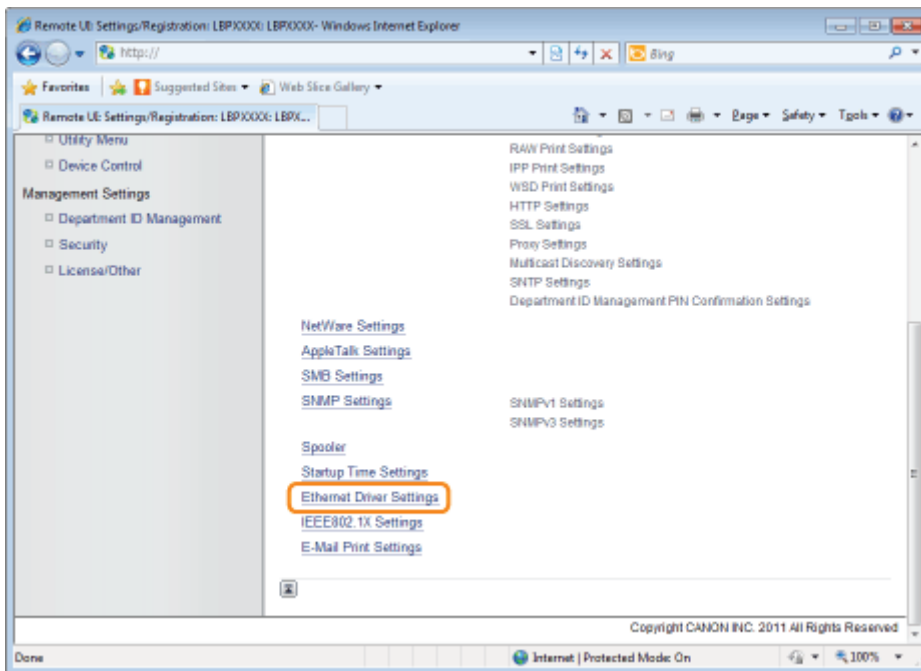

5

Click [Edit...].

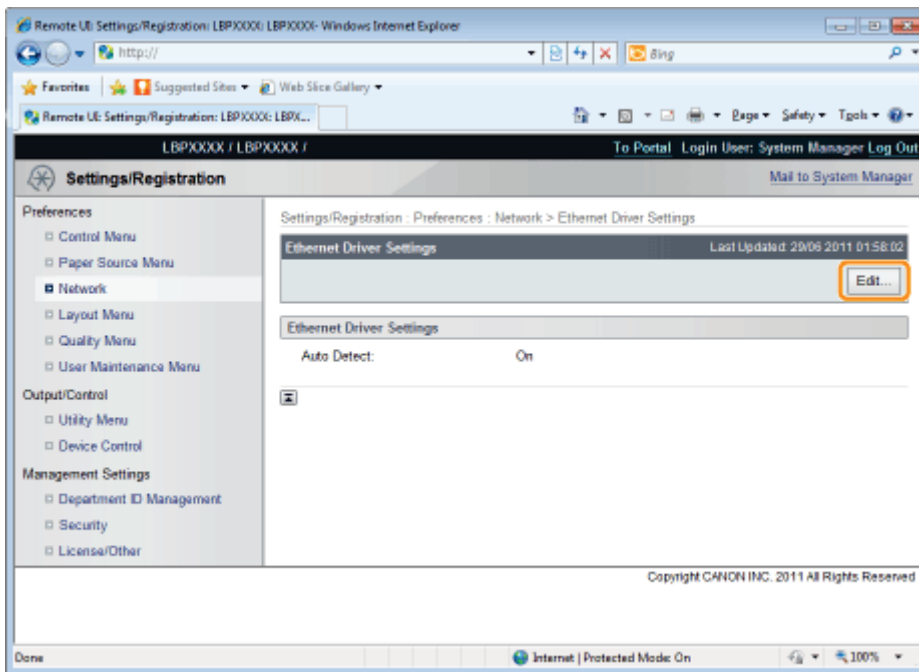

6

Check the MAC address.

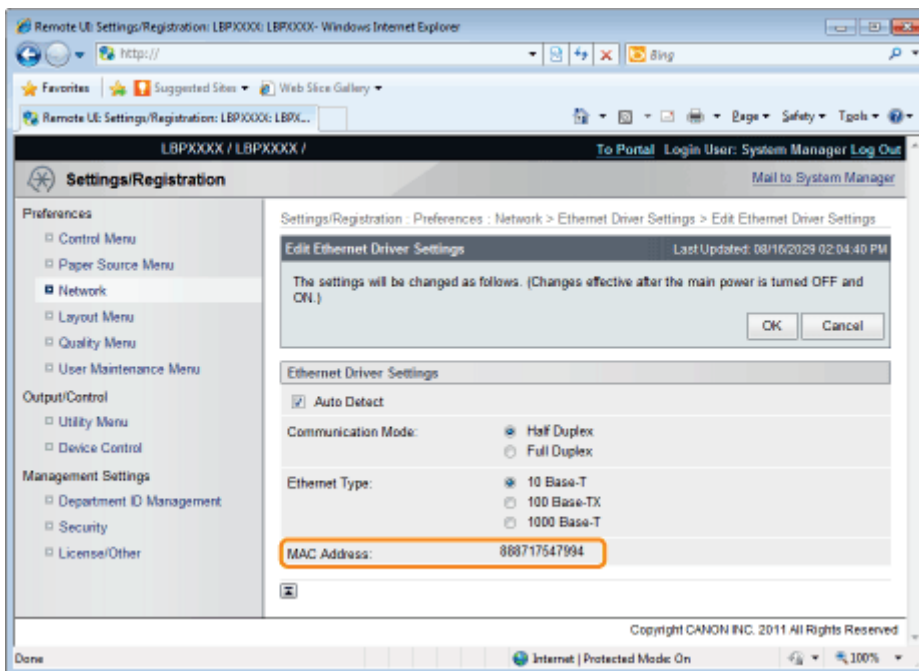

Printing a Network Status Print from the Printer's Control Panel and Checking It

NOTE

Loading A4 paper

The Network Status Print is designed to be printed on A4 paper. Be sure to load A4 paper when printing the Network Status Print.

1

Load A4 paper in the multi-purpose tray or paper drawer.

2

Press [] ( / ): **Utility**).

3

Select [**Network Status Print**] using [▲] and [▼], and then press [OK].

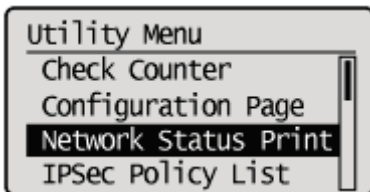

4

Select [**Yes**] using [▼], and then press [OK].

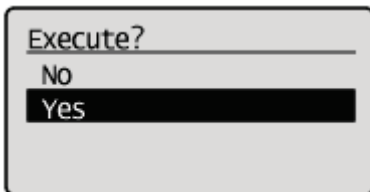

† Network Status Print is printed. The MAC address (A) is indicated in [Ethernet Driver Settings] on the upper left of the Network Status Print.

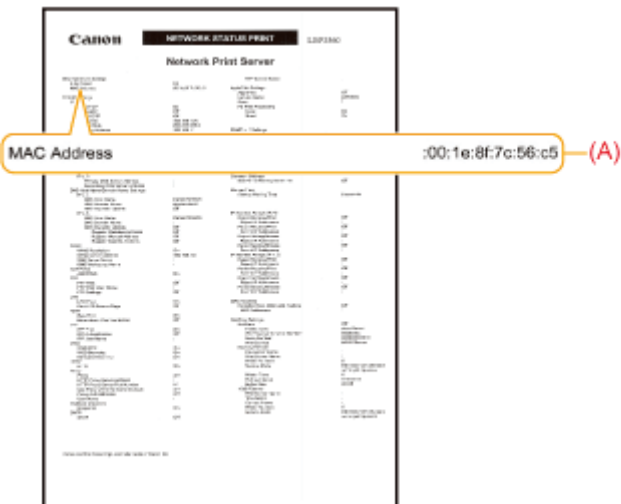

Network Settings for the Printer (TCP/IP)

04L9-08C

The requisite tasks to use the printer in the TCP/IP network are as follows.

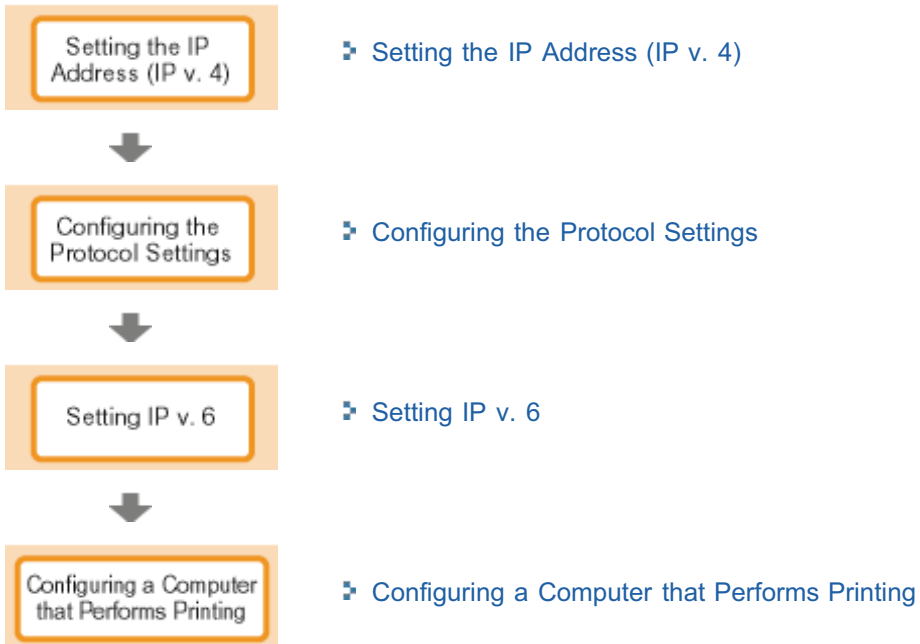

Setting the IP Address (IP v. 4)

04L9-08E

There are the following three methods for setting the IP address.

Setting the IP Address Using the Printer's Control Panel

Set the IP address using the control panel while checking the display on the printer.

Setting the IP Address Using the ARP/PING Commands

Set the IP address using the ARP/PING command in Command Prompt.

Setting the IP Address Using NetSpot Device Installer

Set the IP address using NetSpot Device Installer in the supplied CD-ROM.

IMPORTANT

When setting the IP Address using the ARP/PING command or NetSpot Device Installer

The MAC address of the printer is required. For details on the procedure for checking the MAC address, see "[Checking the MAC Address.](#)"

Before setting the IP address

Make sure that the printer is connected to the network and the printer is ON.

NOTE

If you changed the IP address after installing the printer driver

Specify the port to be used again in the printer driver.

 "[Configuring a Computer that Performs Printing](#)"

Setting the IP Address Using the Printer's Control Panel

04L9-08F

To set the IP address using the printer's control panel, use the following menu hierarchies.

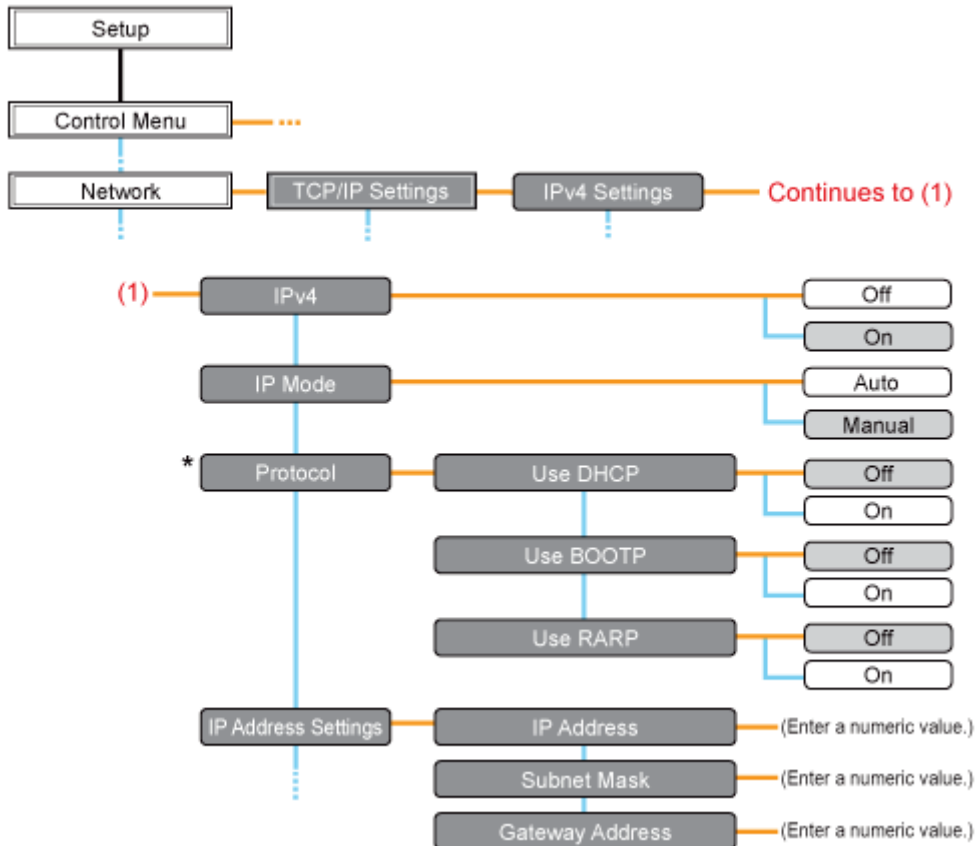

* [Protocol] is displayed when [IP Mode] is set to [Auto].

- Pressing [] ( : Settings) displays the common Setup menu.

— indicates that the procedure is performed by pressing [▲] or [▼] on the control panel.

— indicates that the procedure is performed by pressing [OK] on the control panel.



IMPORTANT

After setting the IP address

To enable the settings, perform a hard reset or restart the printer.

For details on a hard reset, see "[Canceling All the Jobs \(Hard Reset\)](#)."

To go back up the hierarchy

Press [] ( : Back).



About the control panel

For details on the control panel, see "[Control Panel](#)."

1

Press [] ( : Settings), select [Network] using [▲] and [▼], and then press [OK].

When the message is displayed, press [OK].

† You can specify the settings when the printer is either online (the  (Online) indicator is on) or offline (the 

(Online) indicator is off).

2

Select **[TCP/IP Settings]** using [▲] and [▼], and then press **[OK]**.

3

Select **[IPv4 Settings]** using [▲] and [▼], and then press **[OK]**.

4

Set it to use **[IPv4]**.

- (1) After selecting [IPv4] using [▲] or [▼], press [OK].
- (2) After selecting [On] using [▲] or [▼], press [OK].

5

Select the method for setting the IP address.

- (1): Select [IP Mode] using [▲] and [▼], and then press [OK].
- (2): Select a method for setting the IP address using [▲] and [▼], and then press [OK].

[Auto]:	When setting the IP address using any one of DHCP, BOOTP, or RARP, select this option.
[Manual]:	When specifying the IP address to the printer directly, select this option.

6

Set the IP address.

- ❖ If You Selected [Auto] in Step 5
- ❖ If You Selected [Manual] in Step 5

If You Selected **[Auto]** in Step 5

1. Select **[Protocol]** using [▲] and [▼], and then press **[OK]**.
2. Select **[On]** for the option to be used when setting the IP address.

[Use DHCP]:	Obtains an IP address using DHCP. (The DHCP server needs to be running.)
[Use BOOTP]:	Obtains an IP address using BOOTP. (The BOOTP daemon needs to be running.)
[Use RARP]:	Obtains an IP address using RARP. (The RARP daemon needs to be running.)

NOTE

When using DHCP, BOOTP, or RARP

- You can select only one from RARP, BOOTP, or DHCP. One of the following can be used: DHCP, BOOTP, or RARP. When any of the settings is turned [On], the remaining two settings are automatically turned [Off].
- Because it takes approximately two minutes to check whether DHCP, BOOTP, and RARP are available, we recommend that you set the unused protocol(s) to [Off].



When using DHCP

If you cycle the power of the printer, you may not be able to print. This is because a different IP address from the one that has been used is assigned.

When using DHCP, consult your network administrator and perform either of the following settings.

- Specifying the DNS Dynamic Update function
 - ["Configuring the Protocol Settings"](#)
- Specifying the settings so that the same IP address is always assigned when the printer starts up

3. Set the IP address, the subnet mask, and the gateway address manually as needed.

When setting them manually, go back up the hierarchy by pressing [] ( : Back), and then perform the procedure in ["If You Selected \[Manual\] in Step 5."](#)

- † Even if you are using any one of DHCP, BOOTP, or RARP, specify the IP address, subnet mask, and gateway address. If you cannot obtain information from the servers of DHCP, BOOTP, and RARP, the values specified manually are used.

NOTE

When using DHCP, BOOTP, or RARP

You can select only one from RARP, BOOTP, or DHCP.

After the printer restarts, the values obtained from DHCP, BOOTP, and RARP are displayed. (If the values were specified previously, they overwrite the obtained ones.)





4. Proceed to Step 7.

If You Selected [Manual] in Step 5

1. Select [IP Address Settings] using [] and [], and then press [OK].
2. Select [IP Address], [Subnet Mask] and [Gateway Address] using [] and [], press [OK].
3. [IP Address], [Subnet Mask] and [Gateway Address] are each set.

NOTE

How to enter values in [IP Address], [Subnet Mask] and [Gateway Address].

1. Press [] and [] to move the cursor to each field (an area separated by periods to enter three-digit numbers) in which you want to enter respective values of the address. (The numbers in the field blinks, allowing you to enter the value.)
2. Enter the value. (Pressing [] increases the value and [] decreases the value.)
3. After entering values in all the fields, press [OK] to confirm the setting.

4. Proceed to Step 7.

7

Perform a hard reset or restart the printer.

After performing a hard reset or restarting the printer, the settings are effective.

NOTE

For details on a hard reset

See ["Canceling All the Jobs \(Hard Reset\)."](#)





Setting the Printer to a Static IP Address

04L9-0RJ

1

Press [] ( : Settings), select [Network] using [▲] or [▼], and then press [OK].

When the message appears, press [OK].

† You can configure the settings, regardless of whether the printer is online (with the [] ( : Online) indicator turned on) or offline (with the [] ( : Online) indicator turned off).

2

Select [TCP/IP Settings] using [▲] or [▼], and then press [OK].

3

Select [IPv4 Settings] using [▲] or [▼], and then press [OK].

4

Enable [IPv4 Settings].

(1): Select [IPv4] using [▲] or [▼], and then press [OK].

(2): Select [On] using [▲] or [▼], and then press [OK].

5

Select how to configure the IP address.

(1): Select [IP Mode] using [▲] or [▼], and then press [OK].

(2): Select [Manual] using [▲] or [▼], and then press [OK].

6

Configure the IP address.

(1): Select [IP Address Settings] using [▲] or [▼], and then press [OK].

(2): Select [IP Address] using [▲] or [▼], and then press [OK].

(3): Configure [IP Address].

NOTE

How to enter values in [IP address]

1. Move between the fields (four sets of up to three decimal numbers separated by periods) using [◀] or [▶] when entering the IP address you want to configure. (The values in the selected field start flashing for you to

enter the address.)

2. Enter the values. (Press [▲] to increase the value and press [▼] to decrease the value.)
3. When you have finished entering all the values, press [OK] for the setting to take effect.

If you are not sure what to enter in [IP Address]:

If you are not sure what values you should enter for the IP address, contact your network administrator or see "[Determining Which IP Address to Assign to the Printer](#)" for more information.

7

Hard reset or restart the printer.

The settings become effective after hard resetting or restarting the printer.

 **NOTE**

About details of hard reset

See "[Canceling All the Jobs \(Hard Reset\)](#)."

Determining Which IP Address to Assign to the Printer

04L9-0RK

Follow the steps in the procedure below to assign the IP address to the printer.

1

Open the router setup screen.

- † For instructions on how to open the router setup screen, see the instruction manual that comes with the router you are using or consult the manufacturer or your network administrator.

2

Determine which IP address to assign to the printer.

Your router is preconfigured to assign a specific range of IP addresses using DHCP. Check which range of IP addresses your router assigns using DHCP and assign an IP address outside that range to the printer.

- † This prevents this printer from being assigned the same IP address already assigned to another device.

Example: Router setup screen

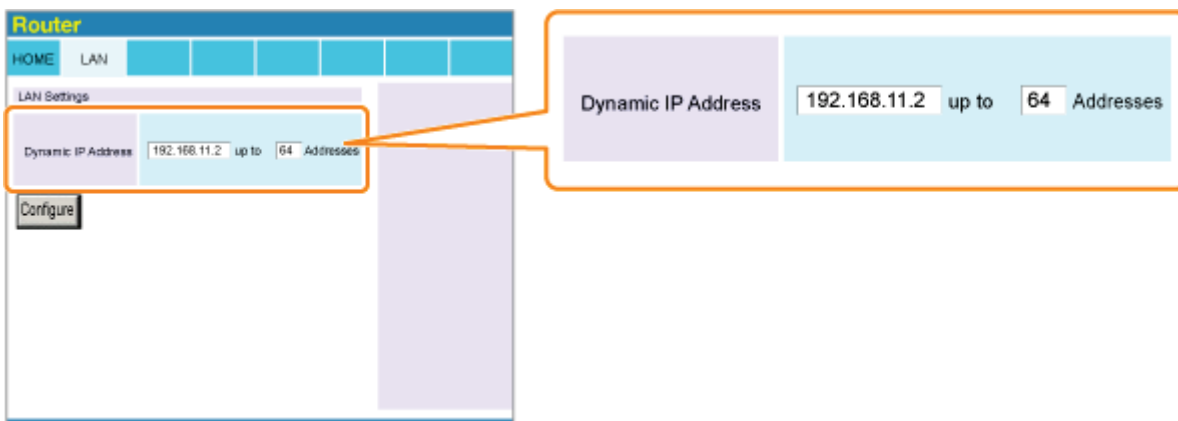

- * This example shows the range of IP addresses the router assigns using DHCP is from 192.168.11.2 to 192.168.11.65. You need to assign an IP address within a range from 192.168.11.66 to 192.168.11.254.

NOTE

IP address

An IP address is a unique address used in order to identify any device connected to a network. It consists of four sets of numbers from 0 to 255 separated by three periods (.), as shown by the example, "192.168.11.1".

Setting the IP Address Using the ARP/PING Commands

04L9-08H

NOTE

If your computer and the printer are connected via the router

You cannot set the IP address using the ARP/PING command.

1

Run Command Prompt.

NOTE

If you are using Windows

Run Command Prompt using the following procedure.

- From the [Start] menu, select [All Programs] or [Programs] → [Accessories] → [Command Prompt].

If you are using Macintosh

Perform the following procedure.

1. Run Terminal.
 - Select the hard disk you use → [Applications] → the [Utilities] folder, and then double-click the [Terminal] icon.
2. Enter "su", and then press the [return] key on your keyboard.
3. "Password:" is displayed. Enter the root password, and then press the [return] key on your keyboard.

If you are using UNIX

Display the console screen, and then log in as a super user.

2

Enter "arp -s <IP address> <MAC address>", and then press the [ENTER] key on your keyboard.

<IP address>:	Enter the IP address to assign to the printer. Specify the address with four numbers (from 0 to 255) separated with a period (.).
<MAC address>:	Enter the MAC address of the printer. When entering the number, separate the number every two digits with a hyphen (-) (a colon (:) for Macintosh/UNIX).

- **Input Example (Windows):** "arp -s 192.168.0.215 00-1E-8F-46-80-2e"
- **Input Example (Macintosh/UNIX):** "arp -s 192.168.0.215 00:1E:8F:46:80:2e"

NOTE

If you are using IBM-AIX

Enter "arp -s ether <the IP address> <the MAC address>."

3

Enter the following command, and then press the [ENTER] key on your keyboard.

- **If you are using Windows:** "ping <the IP Address> -l 479"
- **If you are using Macintosh:** "ping -c 1 -s 479 <the IP Address>"
- **If you are using Solaris 1.x/2.x:** "ping -s <the IP Address> 479"
- **If you are using IBM-AIX:** "ping <the IP Address> 479"
- **If you are using HP-UX:** "ping <the IP Address> 487"
- **If you are using Linux:** "ping -s 479 <the IP Address>"

<IP address>:	Enter the same IP address as the one entered in Step 2.
---------------	---

† Enter a lowercase "l" for "-l."

- **Input Example (Windows):** "ping 192.168.0.215 -l 479"

→ The IP address is set for the printer.

† The subnet mask and gateway address are set to [0.0.0.0].

4

Enter "exit", and then press the [ENTER] key on your keyboard.

→ Command Prompt closes.

Setting the IP Address Using NetSpot Device Installer

04L9-08J

For details on other procedures for starting and using NetSpot Device Installer, see the following.

- Starting method: "Printer Driver Installation Guide"
 - † For details on the procedure for viewing "Printer Driver Installation Guide", see "[Installation](#)."
- Usage: Help of NetSpot Device Installer
 - † Help is displayed by clicking [Help] in the [Help] menu.

IMPORTANT

If Windows Firewall is enabled

Before starting NetSpot Device Installer, configure Windows Firewall to unblock NetSpot Device Installer. For details on the configuration procedure, see the Readme file of NetSpot Device Installer.

For operating systems not compatible with NetSpot Device Installer

Perform the settings from another computer on the network or by using the printer's control panel or the ARP/PING command.

Configuring the Protocol Settings

04L9-08K

This section describes the procedure for specifying the settings using the Remote UI.

† In the Remote UI, you can specify the settings by accessing the printer from a Web browser via a network.

Before specifying the settings, see "Attention (Protocol Settings)."

NOTE

When specifying the settings using software other than the Remote UI

You can also specify the settings using the following software.

❖ "FTP Client"

You can specify the settings by accessing the FTP server of the printer using Command Prompt.

❖ "NetSpot Device Installer"

You can specify the settings using the Canon software, NetSpot Device Installer, in the supplied CD-ROM.

If you want to configure the settings such as the DNS server settings, use the Remote UI or FTP Client.

† The specifiable options vary depending on the software. See "Network Setting Items" and use software appropriate to the network environment you are using or options that you want to specify.

1

Start the Remote UI, and then log in as Administrator.

❖ "Starting the Remote UI"

2

Click [Settings/Registration].

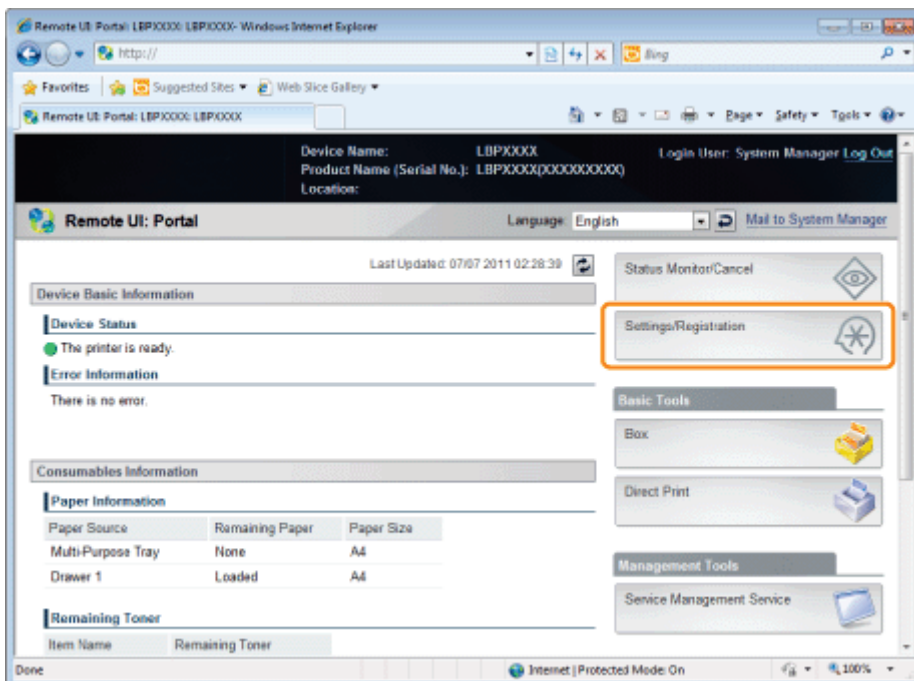

3

Select **[Network]** from the **[Preferences]** menu.

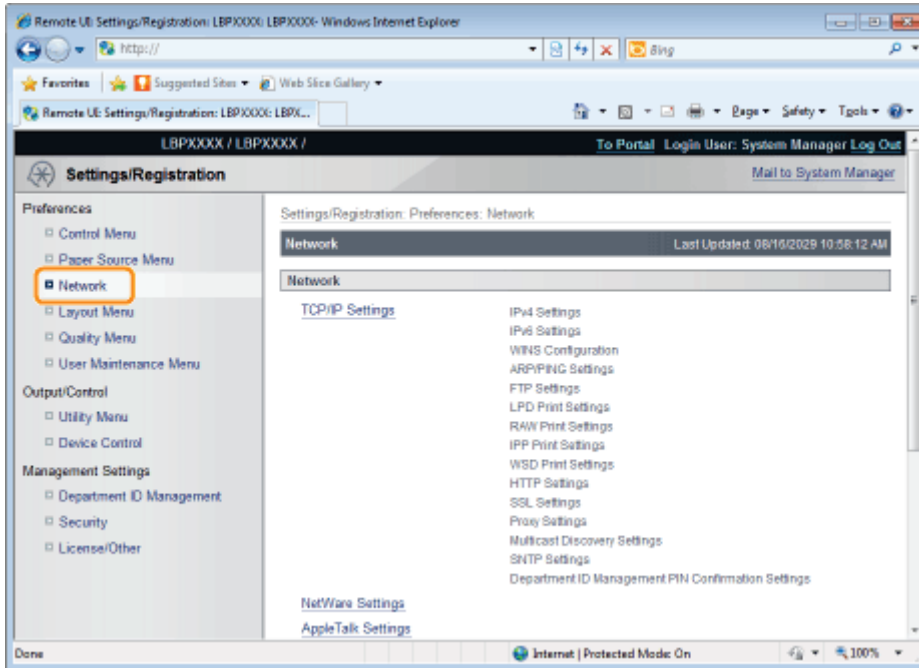

4

Click **[TCP/IP Settings]**.

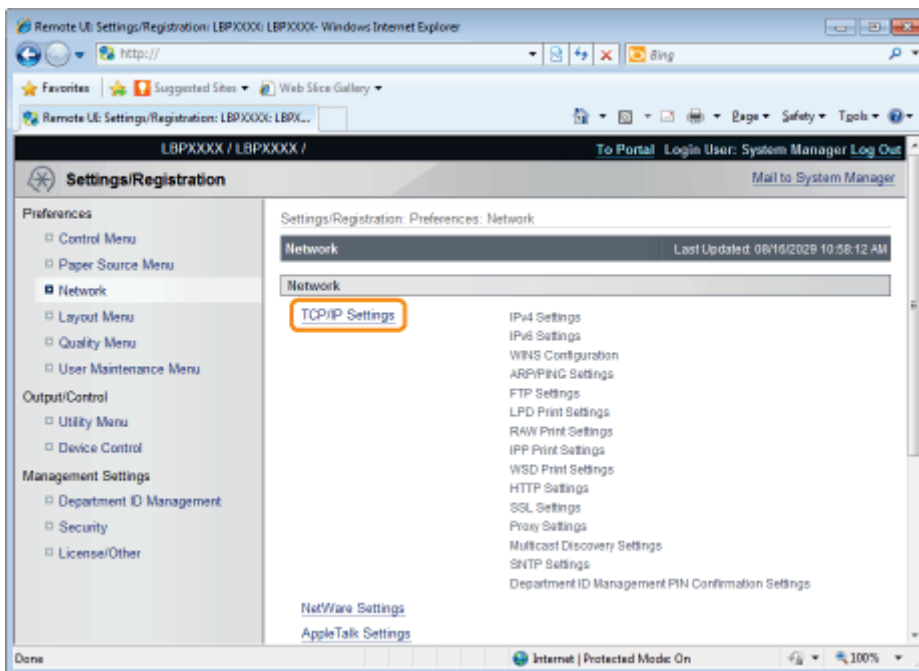

5

Configure the protocol settings.

- ❖ IP Address Settings
- ❖ WINS Settings
- ❖ ARP/PING Settings
- ❖ FTP Settings
- ❖ LPD Settings

- ❖ RAW Settings
- ❖ IPP/IPPS Settings
- ❖ WSD Settings
- ❖ HTTP Settings
- ❖ Setting SSL Keys and Certificates
- ❖ Proxy Settings
- ❖ Multicast Discovery Settings
- ❖ SNMP Settings
- ❖ Department ID Management PIN Configuration Settings (LBP6680x Only)

IP Address Settings

(1) Click [Edit...] in [IPv4 Settings].

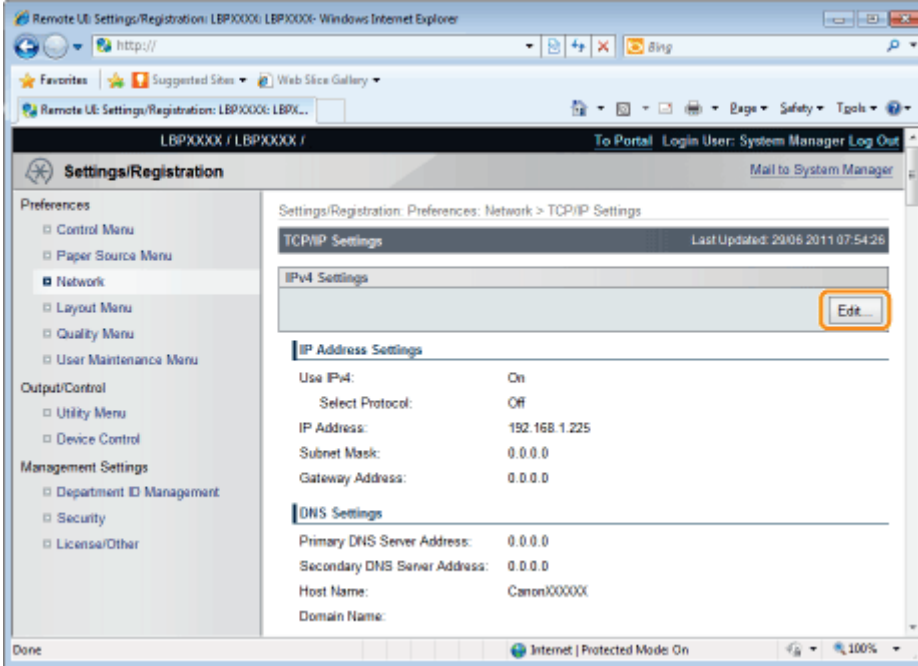

(2) Set the IP address.

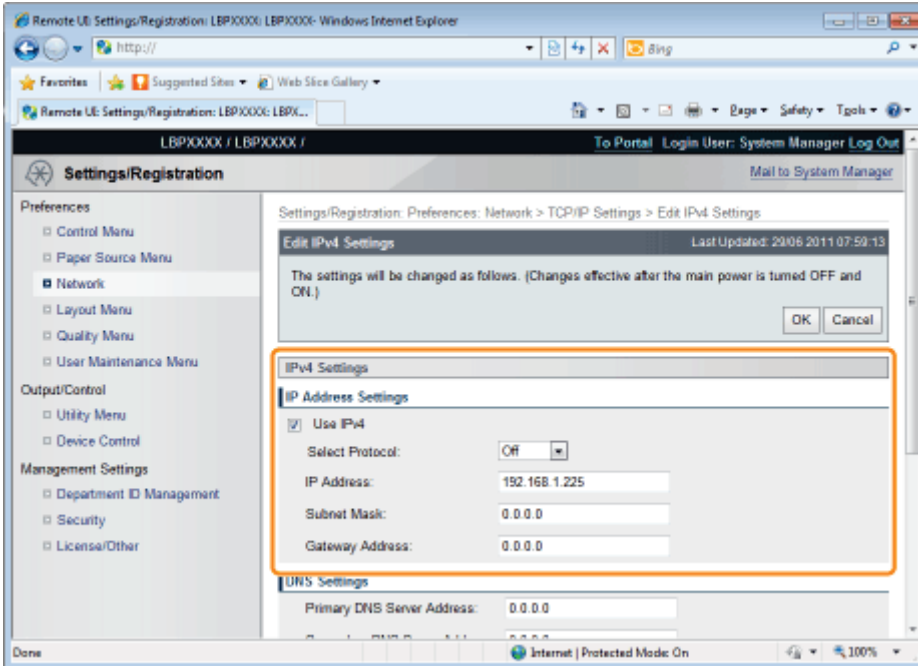

[Use IPv4]	When the check box is selected, use IPv4.
[Select Protocol]	Select the protocol used from [Off], [DHCP], [RARP] or [BOOTP].
When [Off] is selected using [Select Protocol], set the following items.	
[IP Address]	Enter the printer's IP address.

[Subnet Mask]	Enter the subnet mask used by the TCP/IP network.
[Gateway Address]	Enter the gateway address used by the TCP/IP network.

(3) Set DNS.

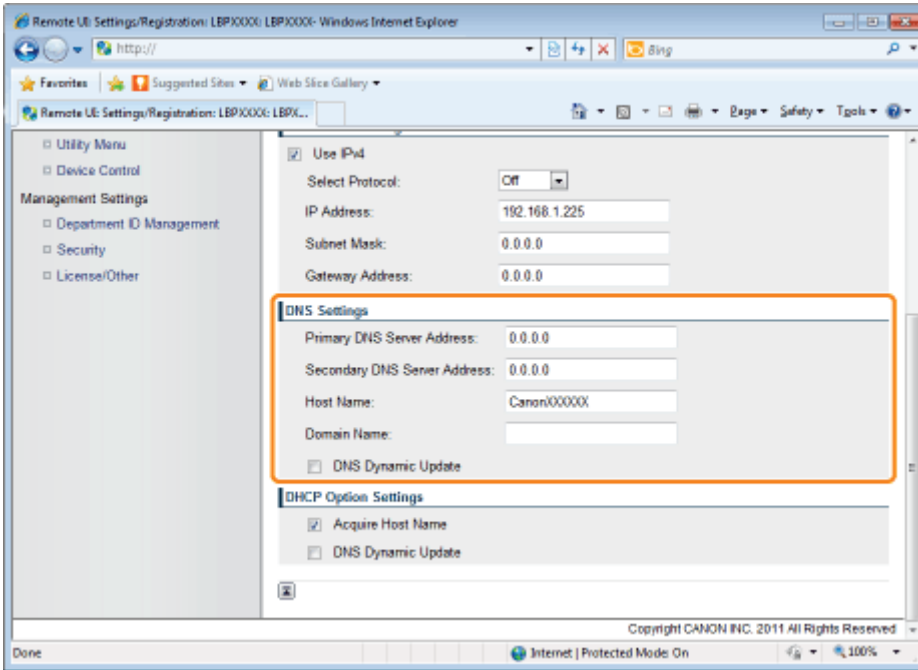

[Primary DNS Server Address]	Enter the IP address of the primary DNS server.
[Secondary DNS Server Address]	Enter the IP address of the secondary DNS server.
[Host Name]	Enter the host name to be added to the DNS server. Up to 47 characters can be entered.
[Domain Name]	Enter the name of the domain to which the printer belongs. Up to 47 characters can be entered. Entry example: "example.com"
[DNS Dynamic Update]	Select the check box when using the DNS Dynamic Update function. When you are not using the DNS Dynamic Update Function, clear the check box. † Using the DNS Dynamic Update function, by registering the [Host Name] and [Domain Name] to the DNS server, the printer's IP address can be used without being fixed.

(4) Set DHCP option settings.

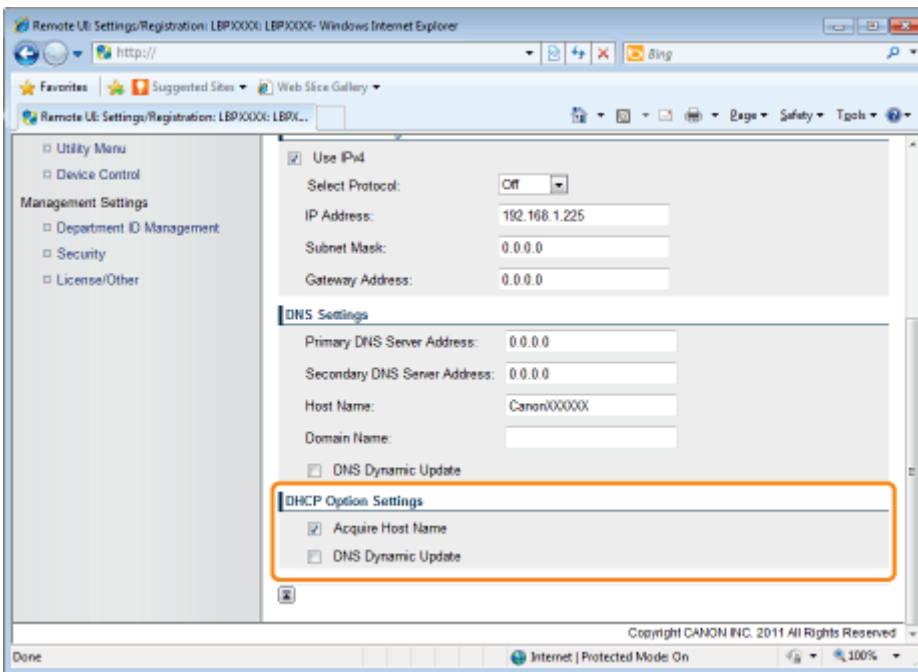

[Acquire Host Name]	When obtaining the host name using DHCP, select the [Acquire Host Name] check box.
[DNS Dynamic Update]	When updating the host name using DHCP, select the [DNS Dynamic Update] check box.

(5) Click [OK].

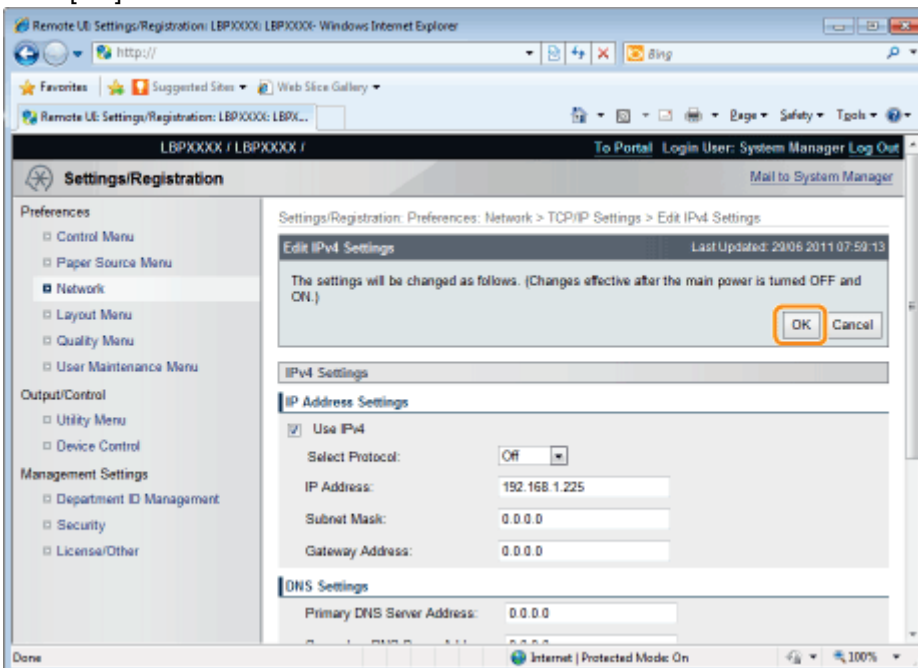

Proceed to Step 6 if you do not specify the settings for the other options.

WINS Settings

(1) Click [Edit...] in [WINS Configuration].

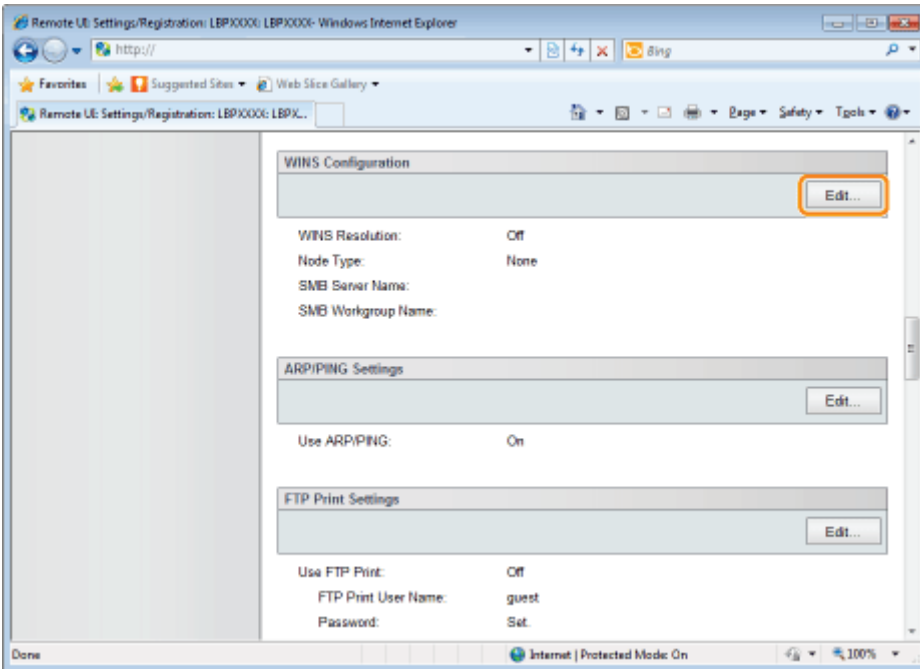

(2) Set WINS.

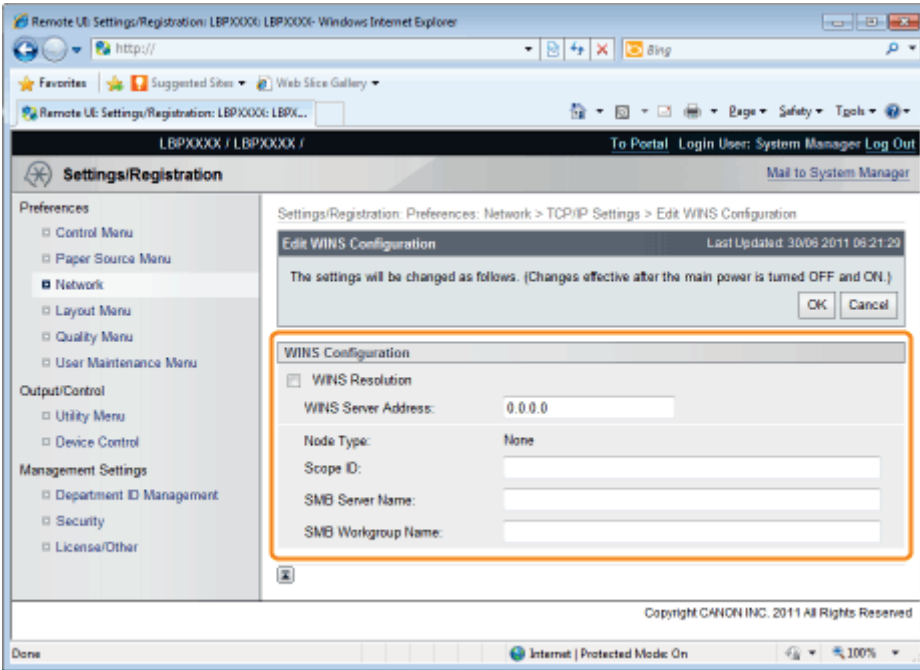

When Using WINS Resolution

Select the [WINS Resolution] check box, and set the following items.

[WINS Server Address]	<p>Enter the IP address of the WINS server.</p> <ul style="list-style-type: none"> † When using the IP address settings specified by DHCP, if you obtain the WINS server IP address from the DHCP server, the IP address obtained from the DHCP server is overwritten.
[Scope ID]	<p>Enter [Scope ID] as needed. You can enter up to 63 characters.</p> <ul style="list-style-type: none"> † The scope ID is an identifier to determine the range available for printers and computers. The scope ID is browsed regardless of the WINS resolution settings. † When a scope ID is not specified for the computer in your network environment, leave the [Scope ID] field blank.

Set the following items when registering printers on the WINS server.	
[SMB Server Name]	<p>Enter the name of the WINS server. You can enter up to 15 characters. (spaces cannot be entered between the characters)</p> <p>† Set the server name that was set here using the SMB function.</p>
[SMB Workgroup Name]	<p>Enter the workgroup name. You can enter up to 15 characters.(spaces cannot be entered between the characters)</p> <p>† Set the workgroup name that was set here using the SMB function.</p>

When not Using WINS Resolution

Clear the [WINS Resolution] check box.

(3) Click [OK].

Proceed to Step 6 if you do not specify the settings for the other options.

ARP/PING Settings

Select whether to use the ARP/PING function.

(1) Click [Edit...] in [ARP/PING Settings].

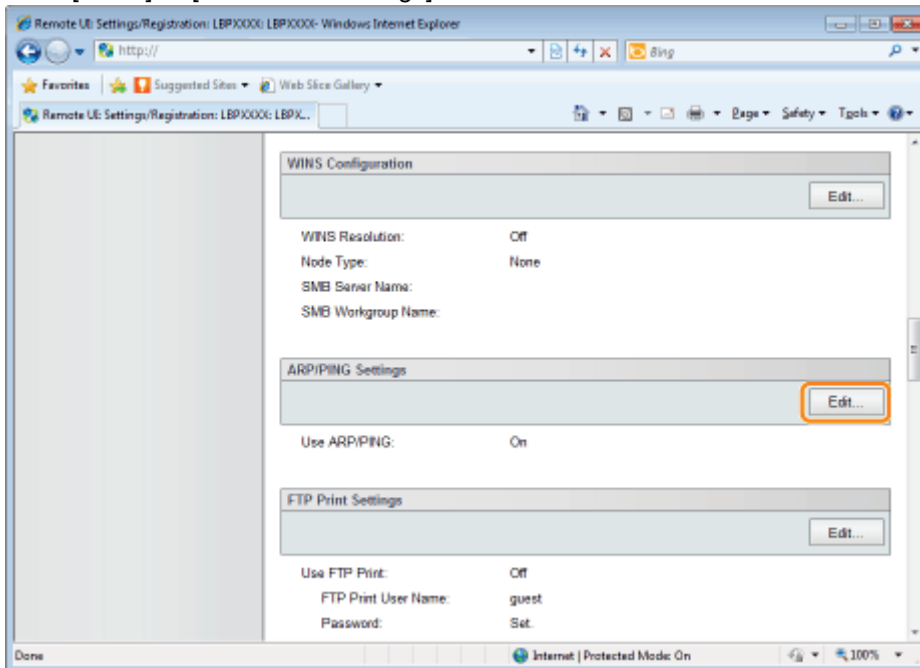

(2) Set ARP/PING.

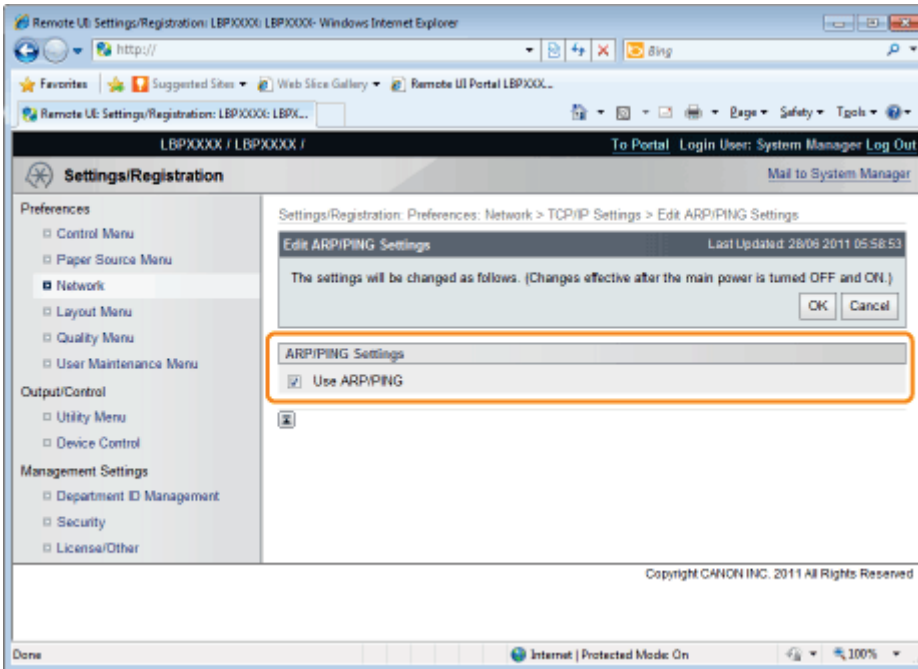

[Use ARP/PING]

When the check box is selected, you can change the IP address settings from the client using the ARP/PING command.

(3) Click [OK].

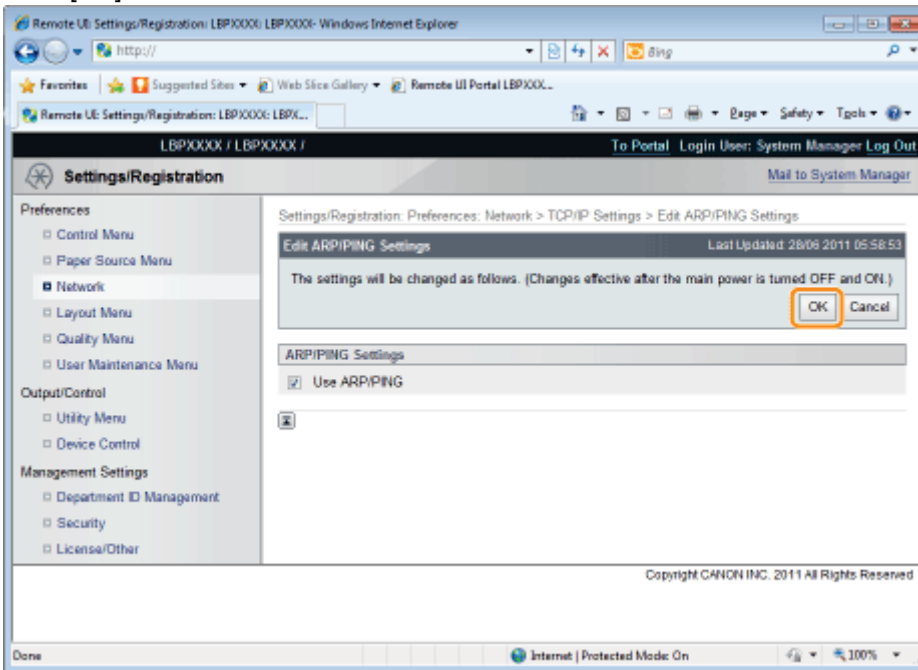

IMPORTANT

When the [Use ARP/PING] check box is cleared

You cannot set the IP address using the ARP/PING command.

 Proceed to Step 6 if you do not specify the settings for the other options.

FTP Settings

(1) Click [Edit...] in [FTP Print Settings].

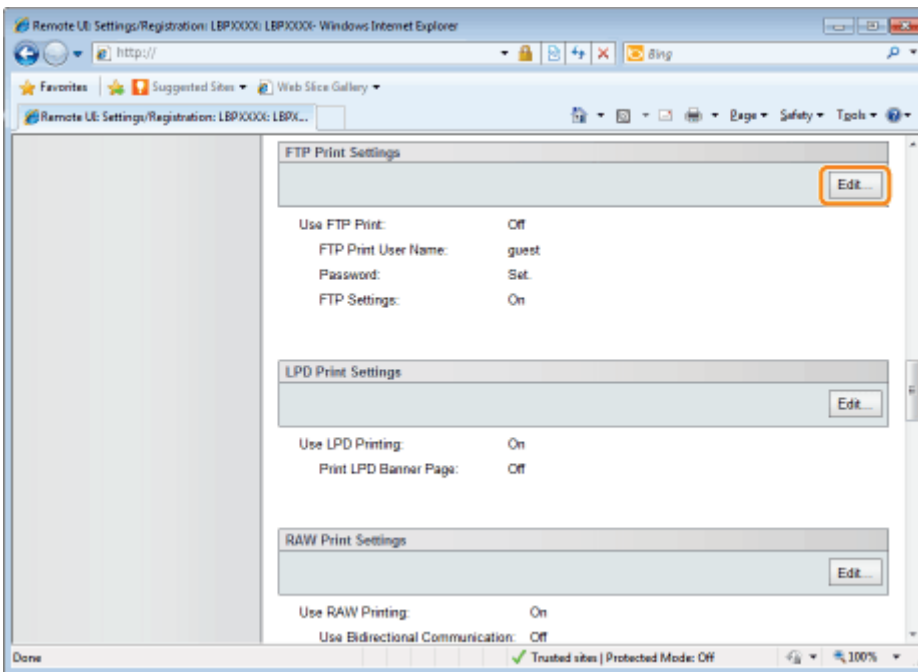

(2) Set FTP print.

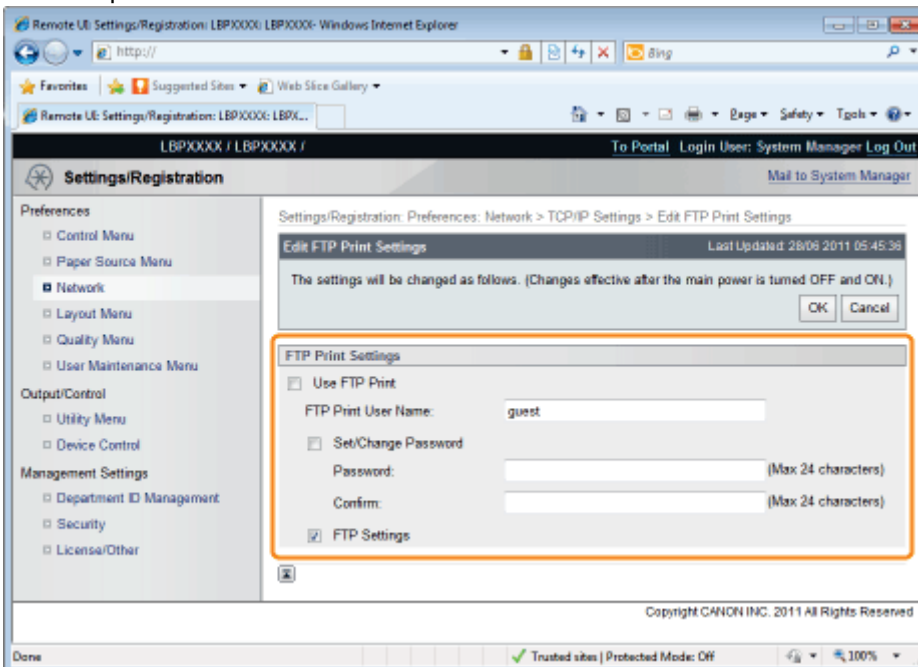

[Use FTP Print]	When the check box is selected, you can access the printer's FTP server using the FTP client and print files.
[FTP Print User Name]	Enter the user name for logging in to the FTP server. Up to 24 alphanumeric characters can be entered. ↑ You cannot set "root."
[Set/Change Password]	Select the check box when setting/changing the password.
[Password]	Enter the password for logging in to the FTP server. Up to 24 alphanumeric characters can be entered.
[Confirm]	To confirm the password, enter the entered [Password] again.
[FTP Settings]	When the check box is selected, changing settings from the FTP client is allowed.

(3) Click [OK].

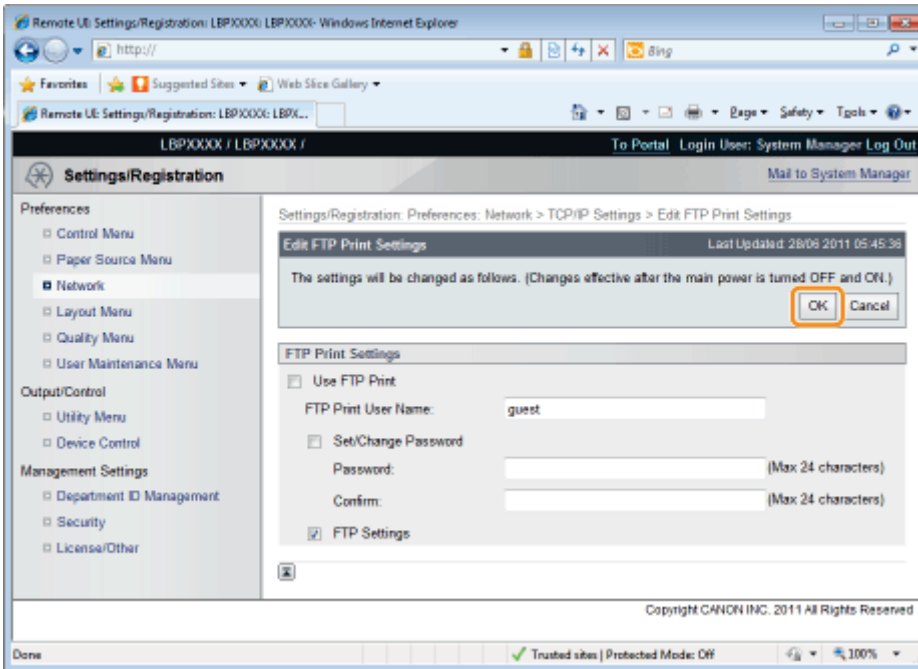

Proceed to Step 6 if you do not specify the settings for the other options.

LPD Settings

- (1) Click [Edit...] in [LPD Print Settings].

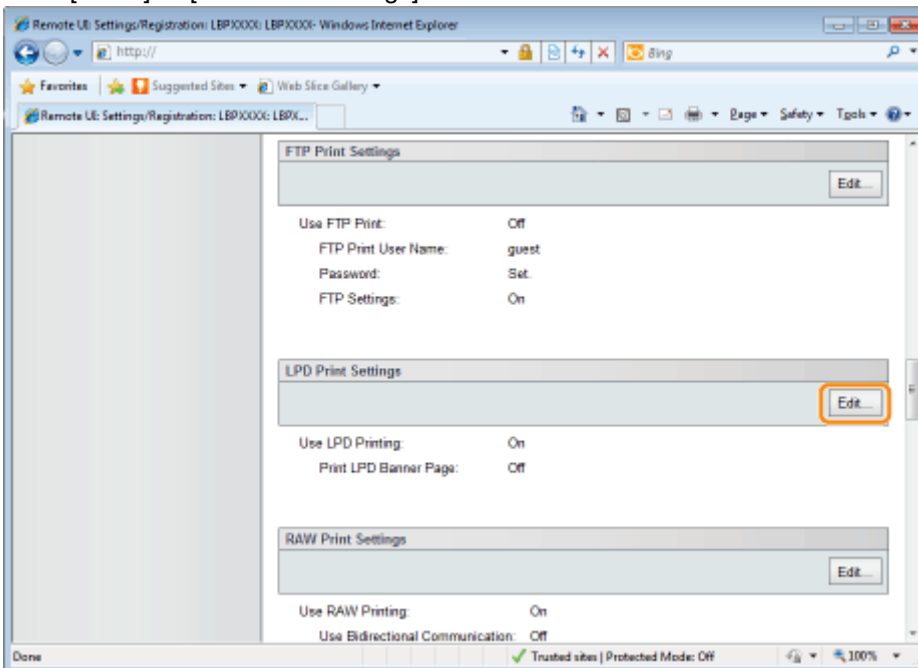

- (2) Set LPD print.

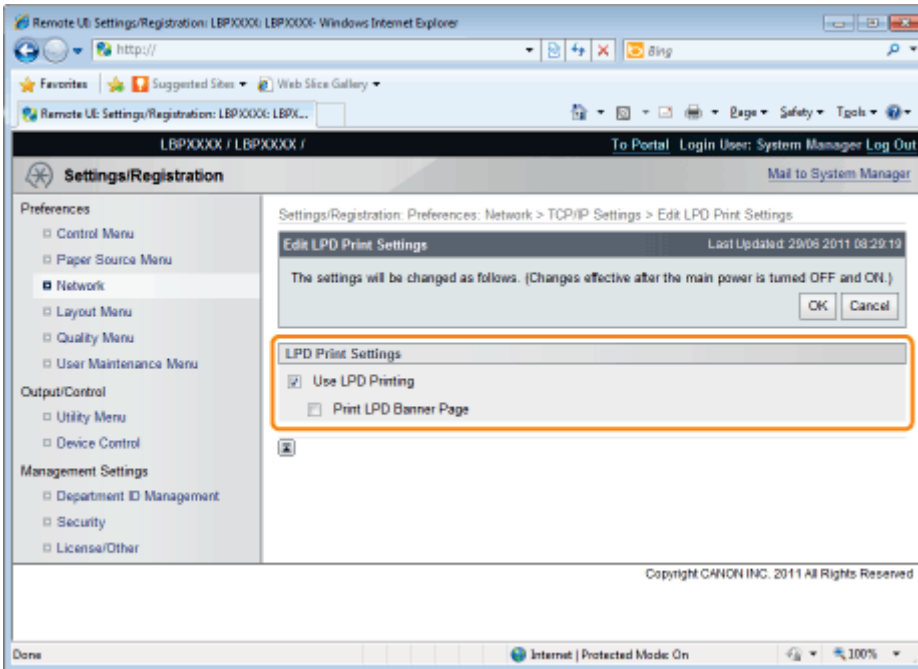

[Use LPD Printing]	When the check box is selected, the LPD print function is enabled.
[Print LPD Banner Page]	<p>When the check box is selected, whenever it prints using LPD applications, a banner page is printed simultaneously.</p> <p>† Banner page printing is set for each job. If the [Print LPD Banner Page] check box is selected, a banner page is printed simultaneously for jobs that are set to print banners. Banner pages are not printed for jobs that are set not to print banner pages.</p> <p>If you are not printing pages, clear the [Print LPD Banner Page] check box. If the [Print LPD Banner Page] check box is cleared, it will not always print banner pages.</p>

(3) Click [OK].

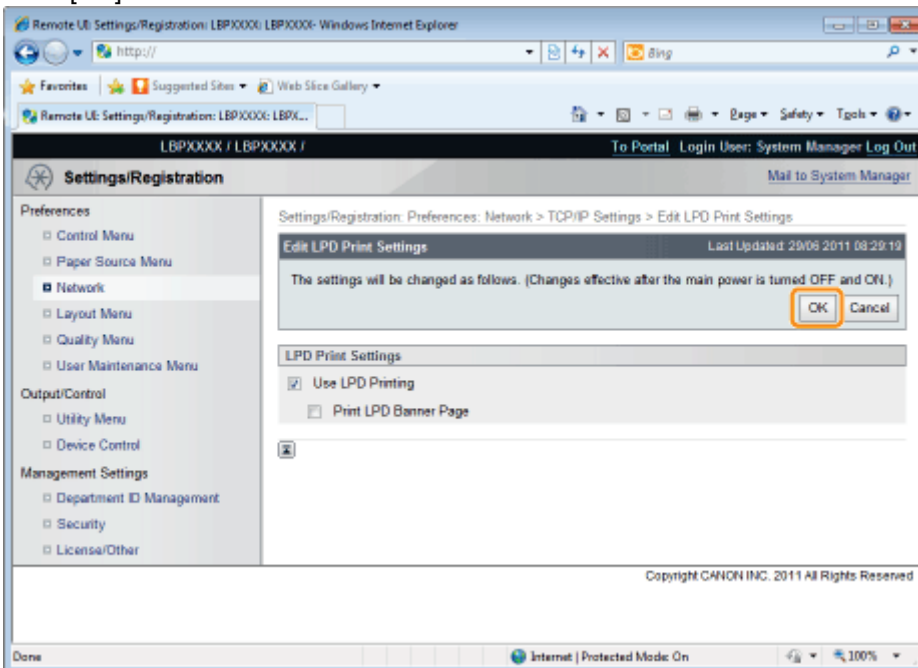

Proceed to Step 6 if you do not specify the settings for the other options.

RAW Settings

† Normally, you do not need to change the settings for this option.

(1) Click [Edit...] in [RAW Print Settings].

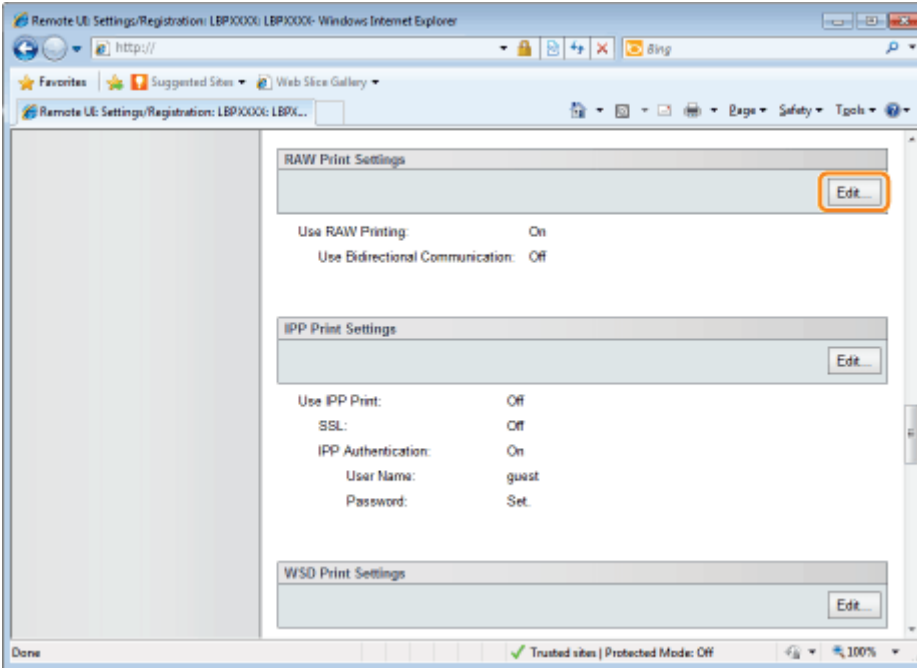

(2) Set RAW printing.

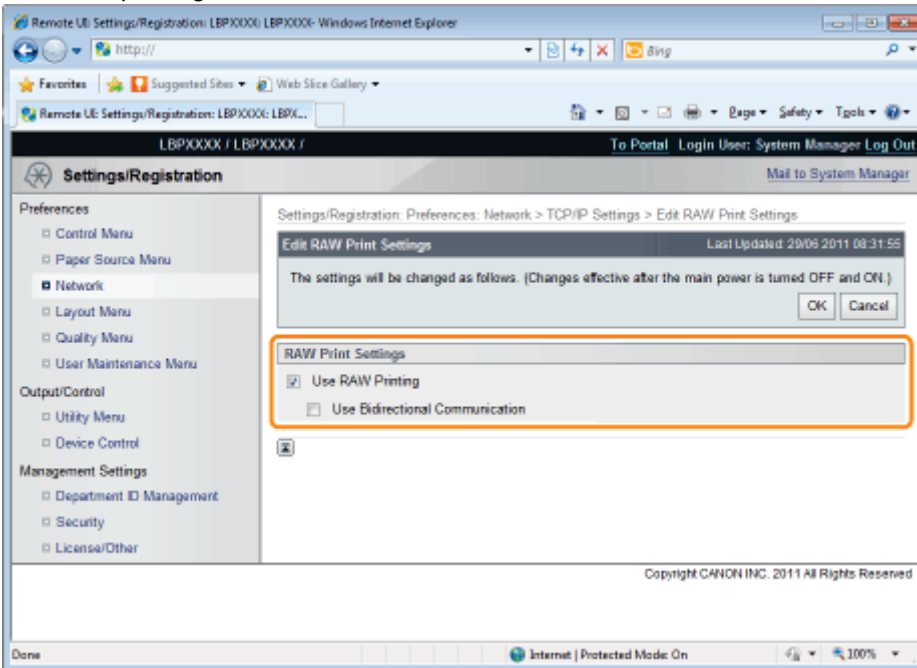

[Use RAW Printing]	When the check box is selected, the RAW printing function is enabled.
[Use Bidirectional Communication]	When the check box is selected, bidirectional communication is performed.

(3) Click [OK].

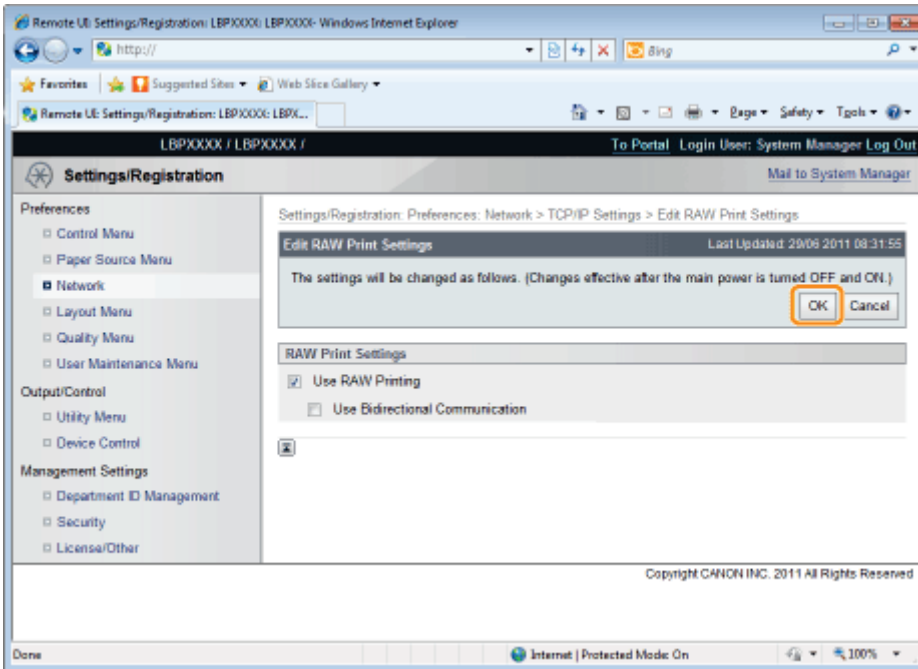

Proceed to Step 6 if you do not specify the settings for the other options.

IPP/IPPS Settings

(1) Click [Edit...] in [IPP Print Settings].

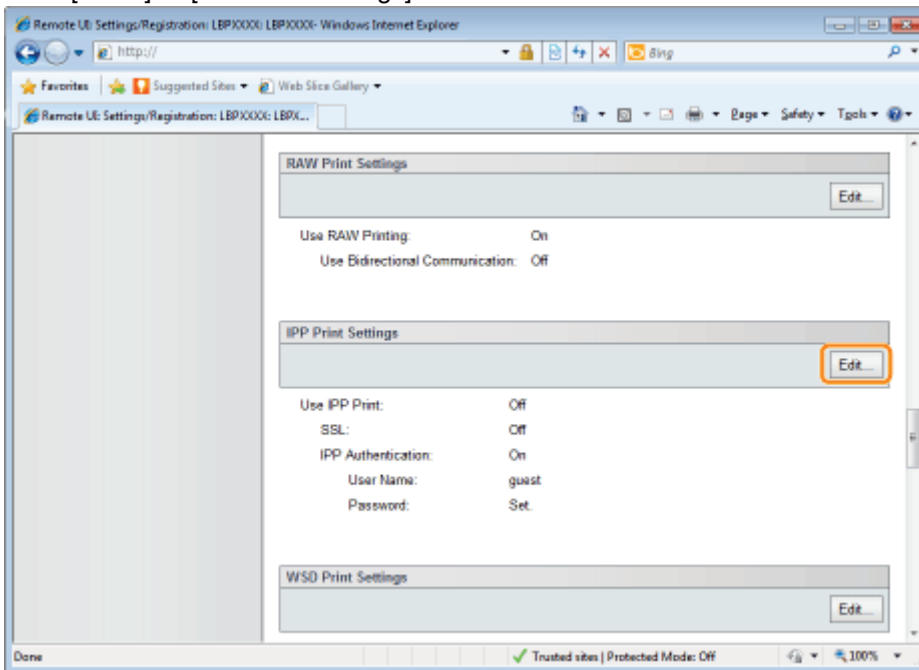

(2) Set IPP print.

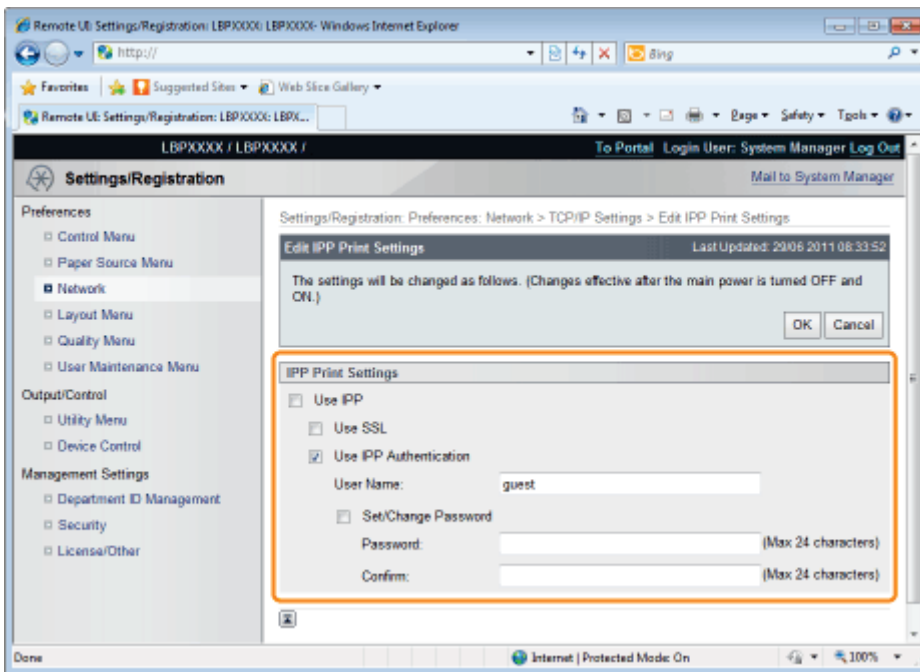

To Use IPP/IPPS Printing

Select the [Use IPP] check box, and set the following items.

[Use SSL]	<p>When the check box is selected, you can use IPPS (encryption of IPP communication data using SSL).</p> <ul style="list-style-type: none"> † You can only use IPPS when the SSL encrypted communication function is enabled. † You cannot select the [Use SSL] check box if a key and certificate have been created but the use key is not registered. See "Selecting Keys and Certificates" for more information about SSL encrypted communication functions and key registration procedures.
[Use IPP Authentication]	When the check box is selected, use the IPP print user authentication function.
When the [Use IPP Authentication] check box is selected, set the following items.	
[User Name]	Enter the user name used for the IPP print user authentication function. Up to 24 characters can be entered.
[Set/Change Password]	Select the check box when setting/changing the password.
[Password]	Enter the password used for the IPP print user authentication function. Up to 24 characters can be entered.
[Confirm]	For confirmation, enter the same [Password] again.

IMPORTANT

When the [Use IPP] check box is selected

The HTTP setting [Use HTTP] turns [On] automatically.

➤ "[HTTP Settings](#)"

When Not Using IPP/IPPS Printing

Clear the [Use IPP] check box.

(3) Click [OK].

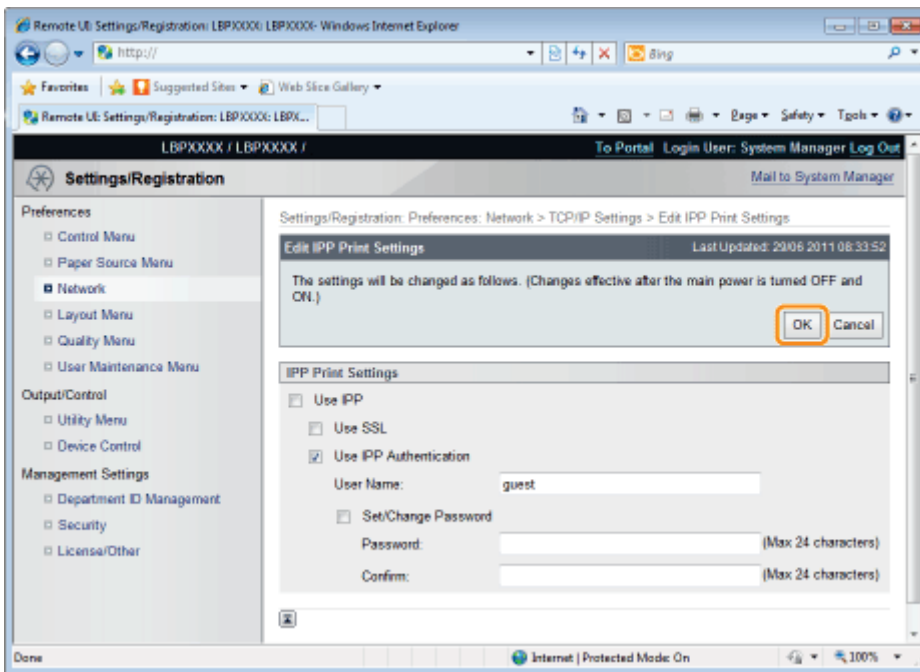

Proceed to Step 6 if you do not specify the settings for the other options.

WSD Settings

- Click [Edit...] in [WSD Print Settings].

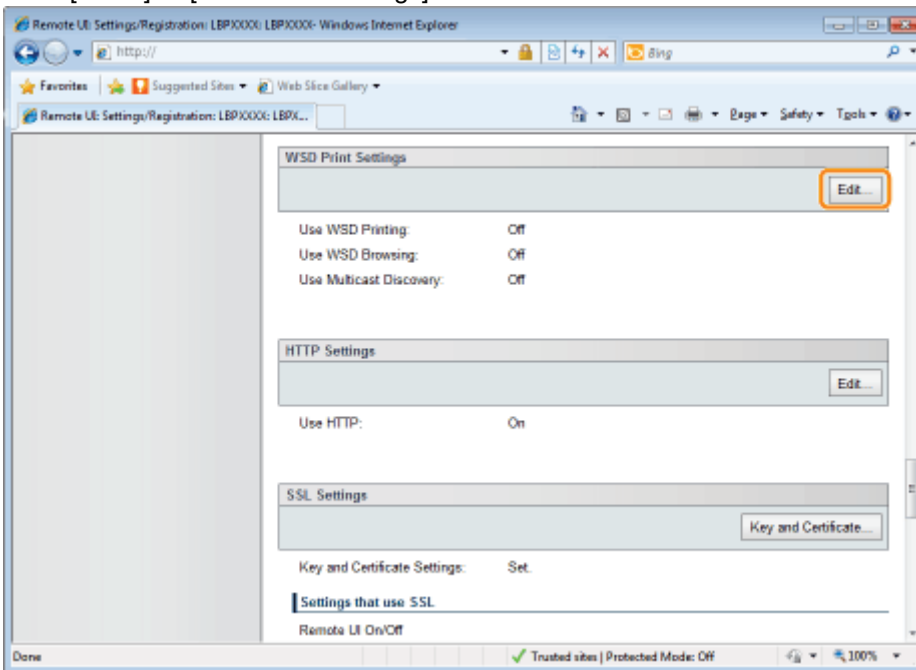

- Set WSD printing.

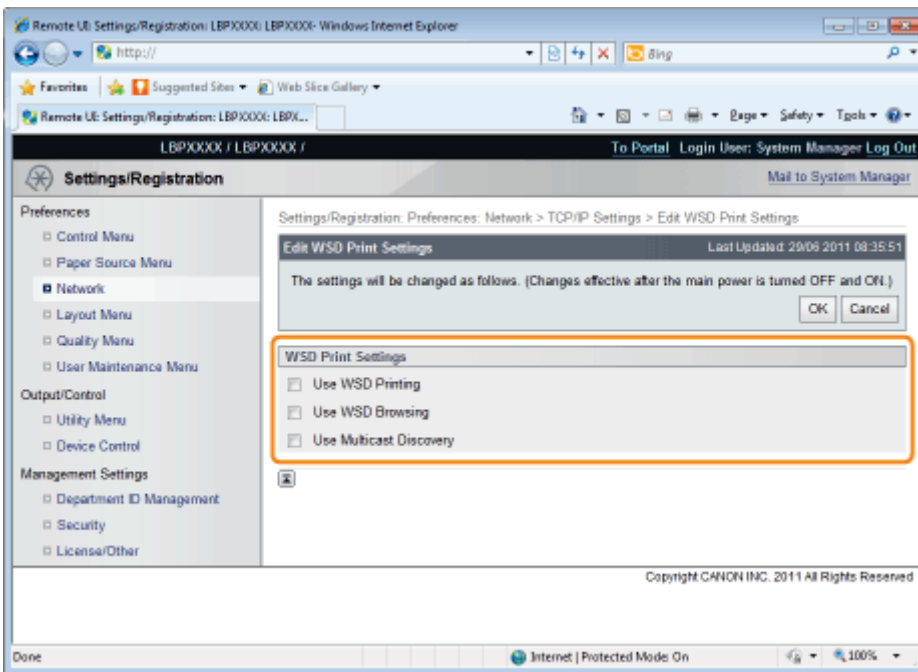

[Use WSD Printing]	Select the check box to use WSD printing.
[Use WSD Browsing]	When the check box is selected, it obtains printer information using WSD reference. † If you select the [Use WSD Printing] check box, the [Use WSD Browsing] check box will always be selected. You can only clear the [Use WSD Browsing] check box when the [Use WSD Printing] check box is cleared.
[Use Multicast Discovery]	Select the check box to use Multicast Discovery.

(3) Click [OK].

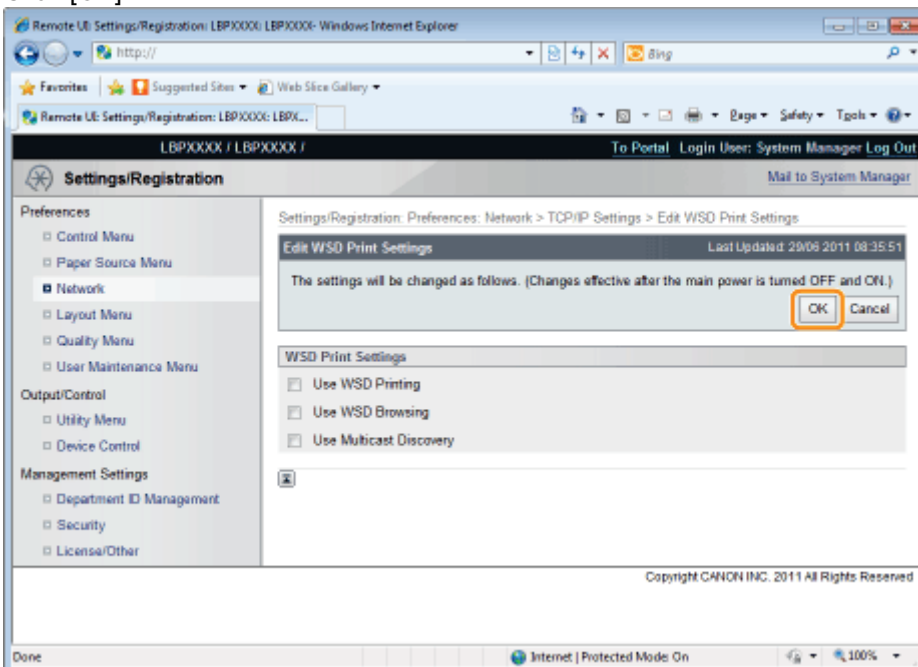

Proceed to Step 6 if you do not specify the settings for the other options.

HTTP Settings

Specify whether to use the HTTP function.

(1) Click [Edit...] in [HTTP Settings].

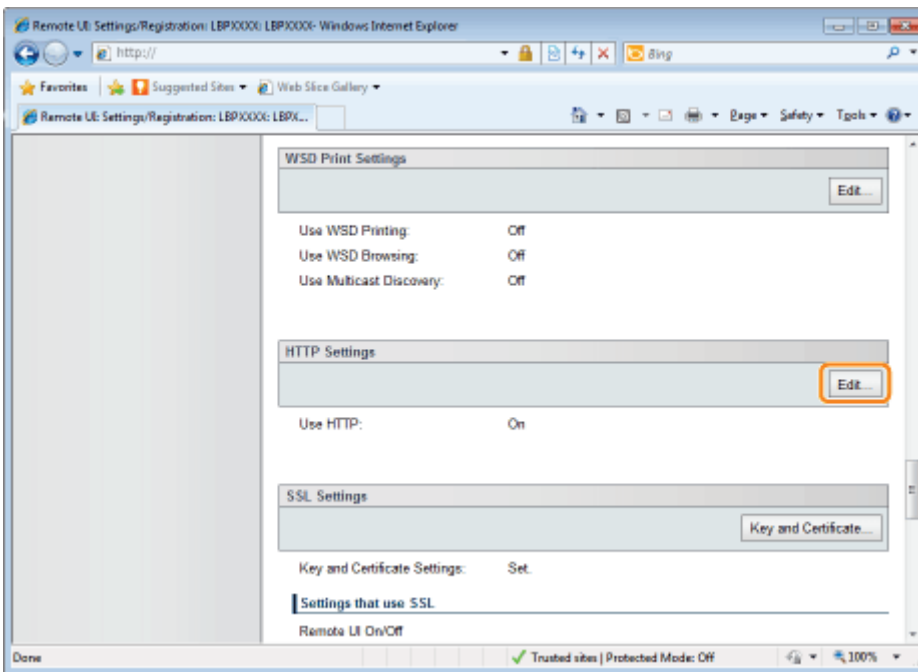

(2) Set HTTP.

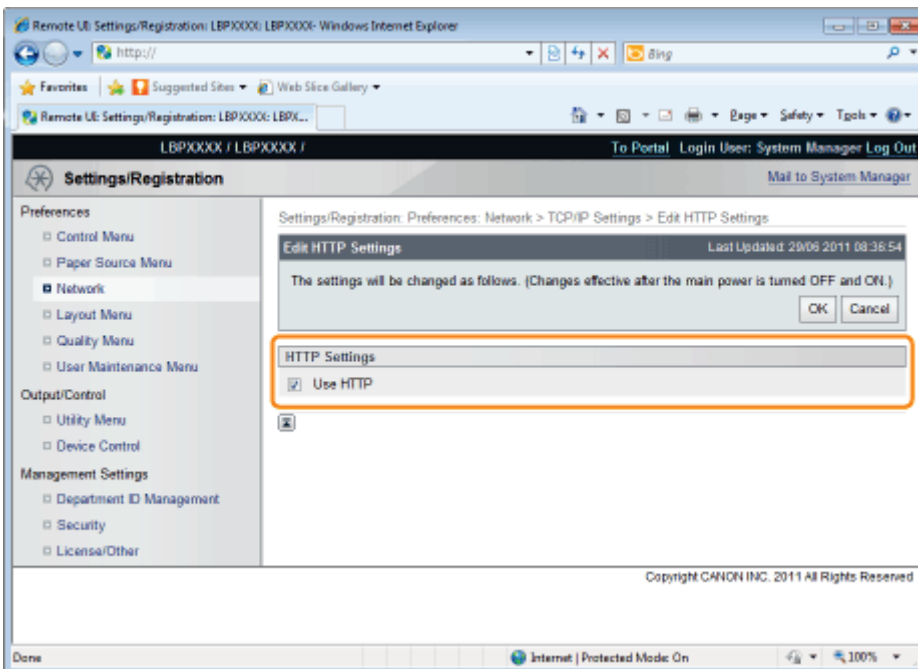

[Use HTTP]	When the check box is selected, you can access the printer using HTTP.
------------	--

IMPORTANT

When the [Use HTTP] check box is cleared

The settings on the functions using HTTP change automatically, as shown below.

[Use IPP Print]	[Off]
[Remote UI]*	[Off]

* Can only be set from the printer's control panel and the FTP client

If the [Use HTTP] check box is cleared, you will not be able to use IPP print or Remote UI, so consult with the network administrator before you set it.

(3) Click [OK].

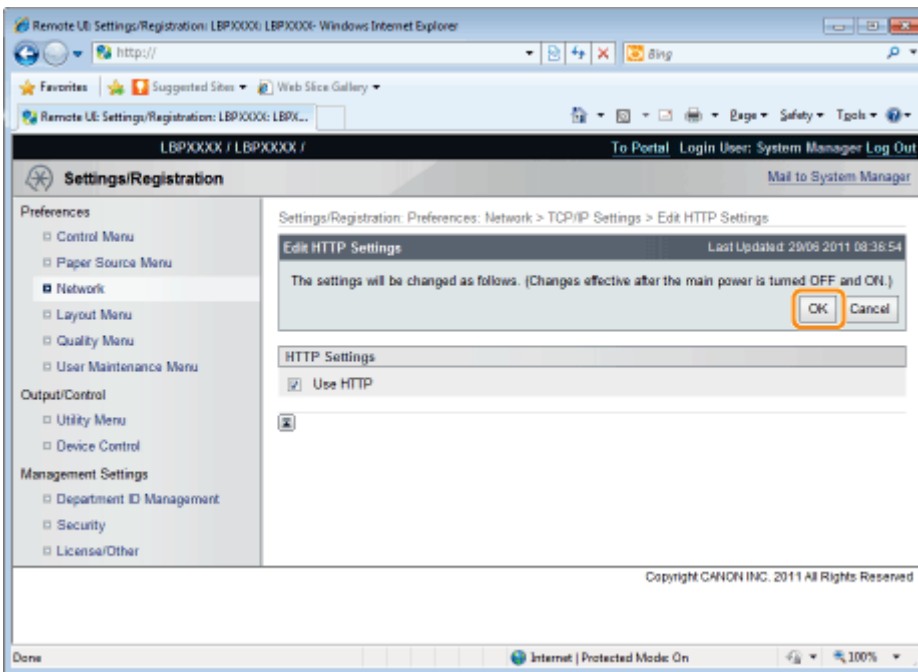

Proceed to Step 6 if you do not specify the settings for the other options.

Setting SSL Keys and Certificates

Check the key used for SSL.

See "[Selecting Keys and Certificates](#)" for more information about SSL encrypted communication functions and key registration and selection procedures.

Proxy Settings

(1) Click [Edit...] in [Proxy Settings].

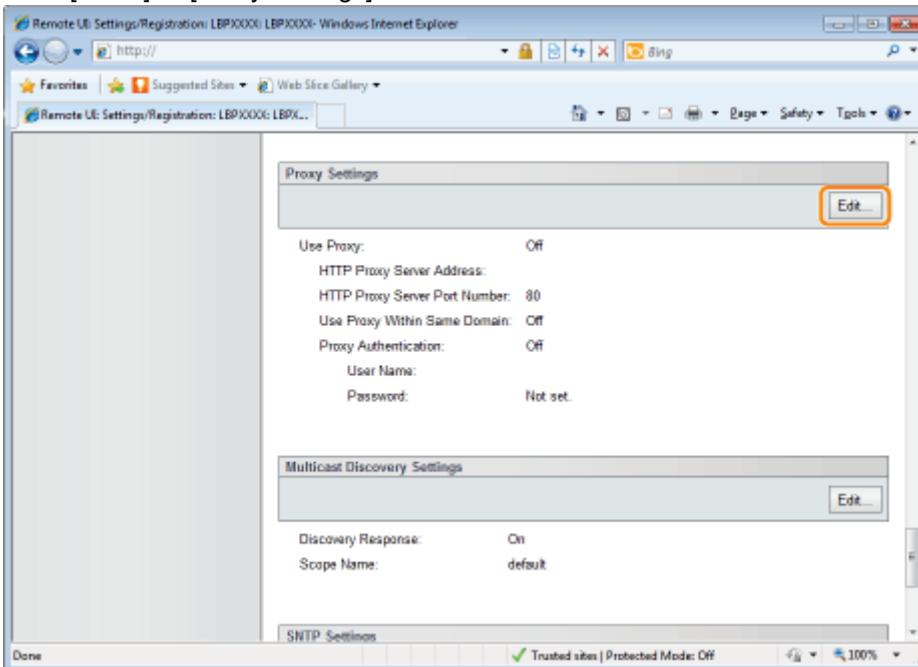

(2) Set proxy functions.

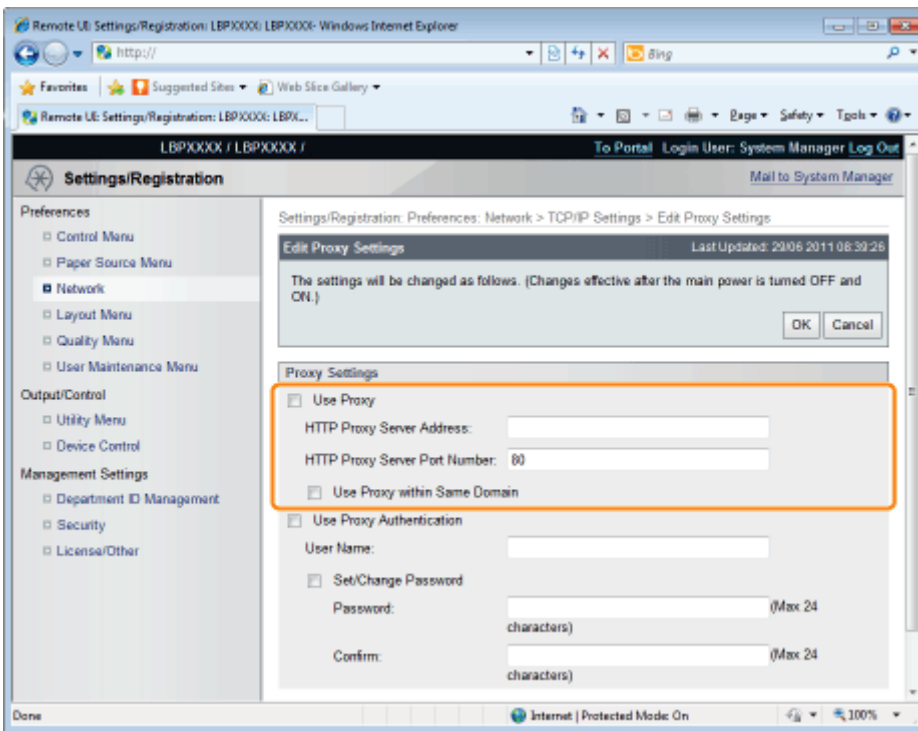

When using proxy functions

Select the [Use Proxy] check box, and set the following items.

[HTTP Proxy Server Address]	Enter the address of the proxy server used by the proxy functions.
[HTTP Proxy Server Port Number]	Enter the port number of the proxy server used by the proxy functions. You can set it between [0] and [99999].
[Use Proxy within Same Domain]	When the check box is selected, use the proxy function within the same domain.

When not using proxy functions

Clear the [Use Proxy] check box.

(3) Set proxy authentication functions.

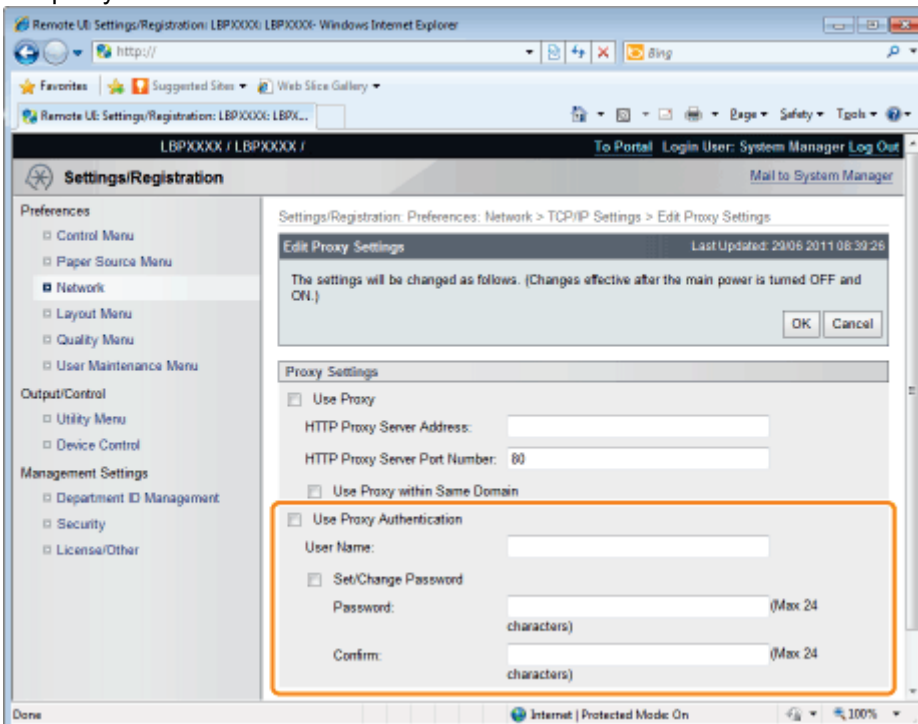

When using proxy authentication functions

Select the [Use Proxy Authentication] check box, and set the following items.

[User Name]	Enter the user name used for proxy authentication. Up to 24 alphanumeric characters can be entered.
[Set/Change Password]	Select the check box to use a password for proxy authentication. When you are not using a password for proxy authentication, clear the check box.
[Password]	When [Set/Change Password] is selected, enter the password used for proxy authentication. Up to 24 alphanumeric characters can be entered.
[Confirm]	To confirm the password, enter the entered [Password] again.

When not using proxy authentication functions

Clear the [Use Proxy Authentication] check box.

(4) Click [OK].

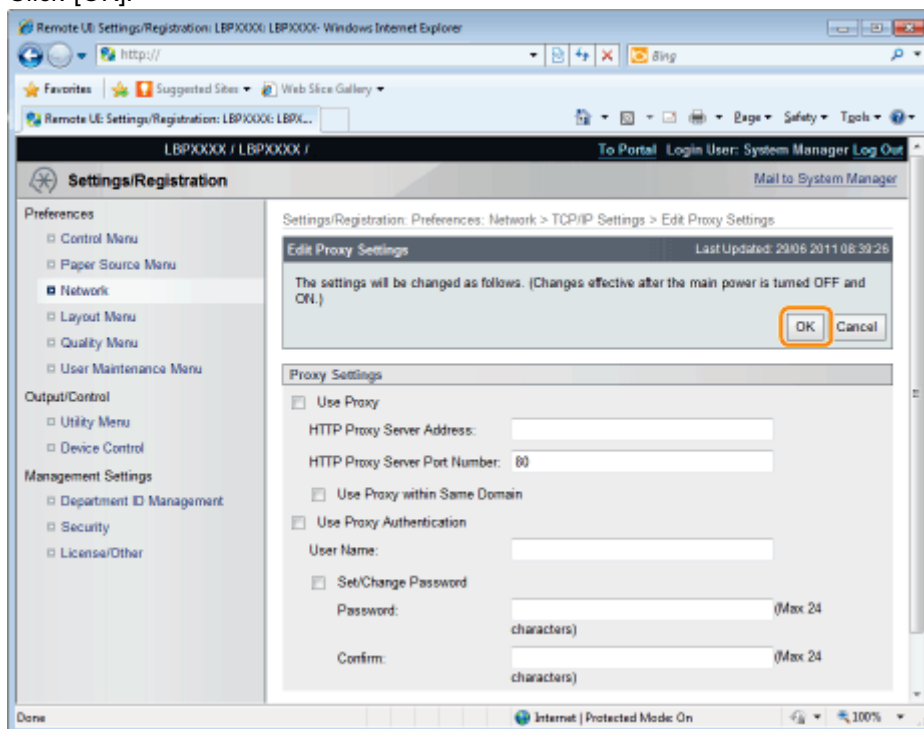

 Proceed to Step 6 if you do not specify the settings for the other options.

Multicast Discovery Settings

Set whether the printer will respond to device searches over the network using Multicast Discovery.

(1) Click [Edit...] in [Multicast Discovery Settings].

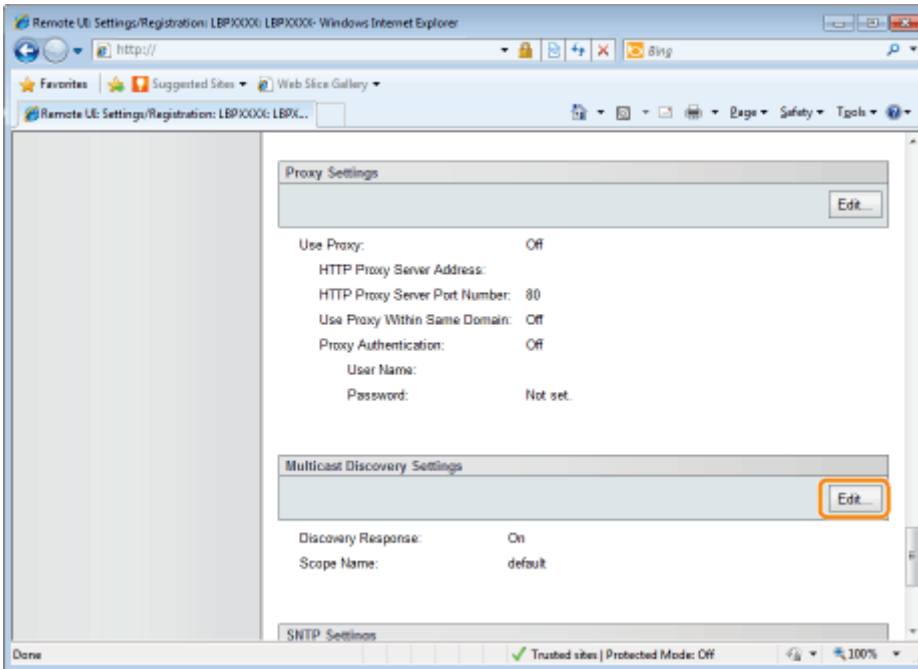

(2) Set Multicast Discovery.

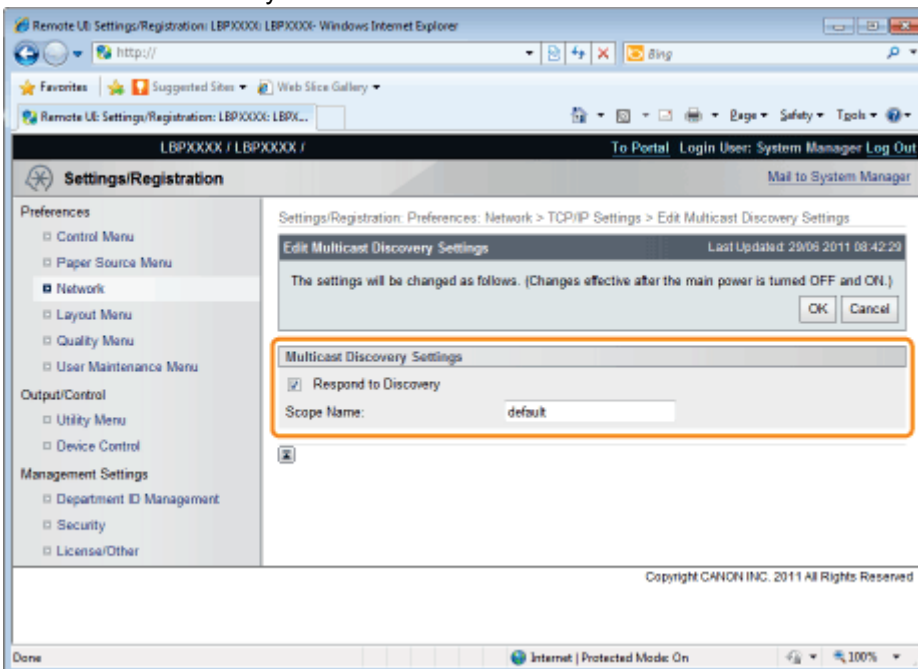

[Respond to Discovery]	Select the check box to allow it to respond to a multicast search request.
[Scope Name]	Enter the scope name used when a specified device is searched from utility software such as NetSpot Device Installer using multicast. Up to 32 characters can be entered. † You cannot use any of the following characters: "(", ")", ",", "!", "<", ">", "=", "~", ";", "+", "*", "\."

(3) Click [OK].

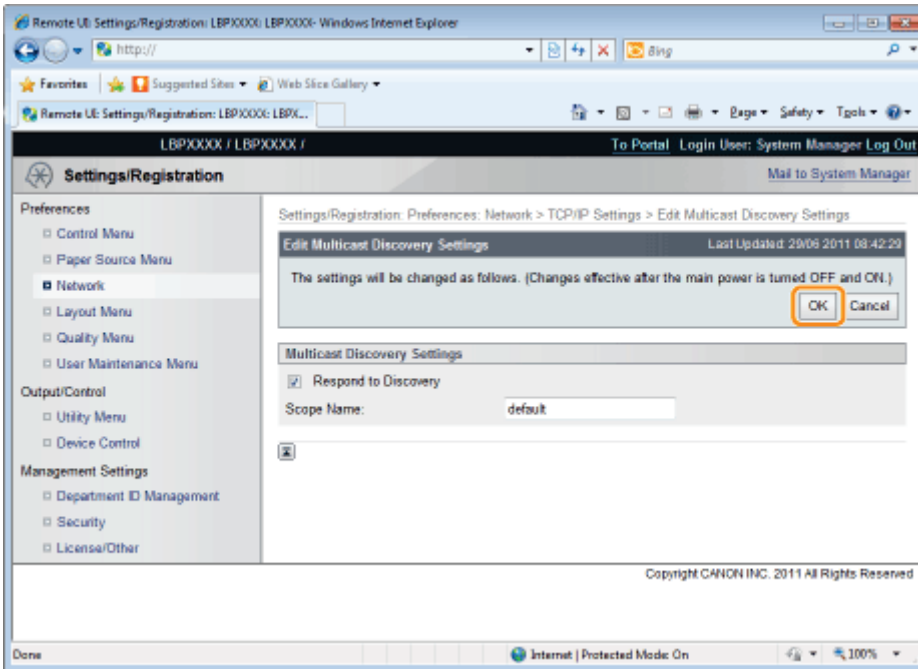

Proceed to Step 6 if you do not specify the settings for the other options.

SNTP Settings

Set whether to synchronize the printer time with the NTP server.

- (1) Click [Edit...] in [SNTP Settings].

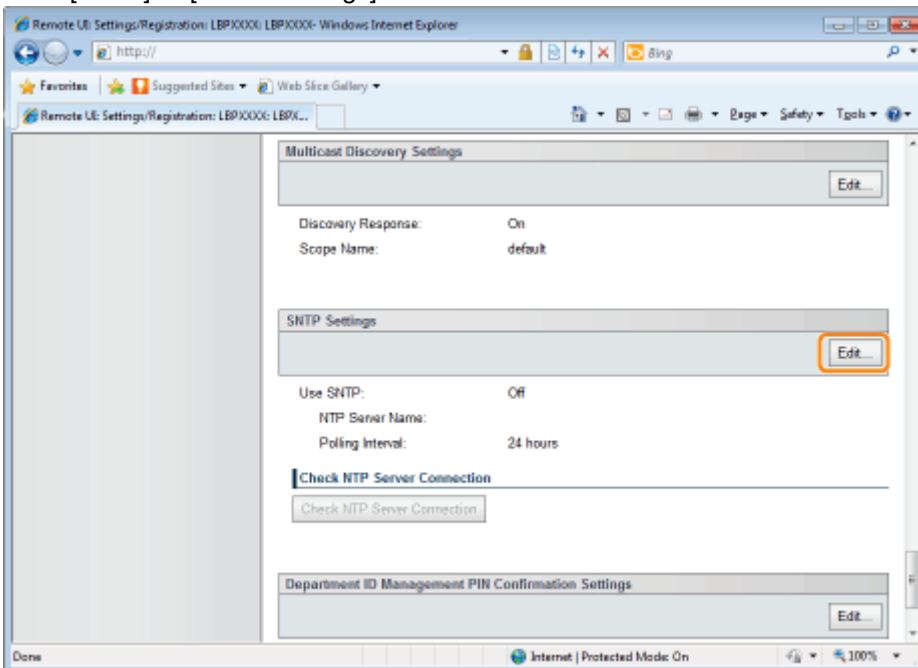

- (2) Set SNTP.

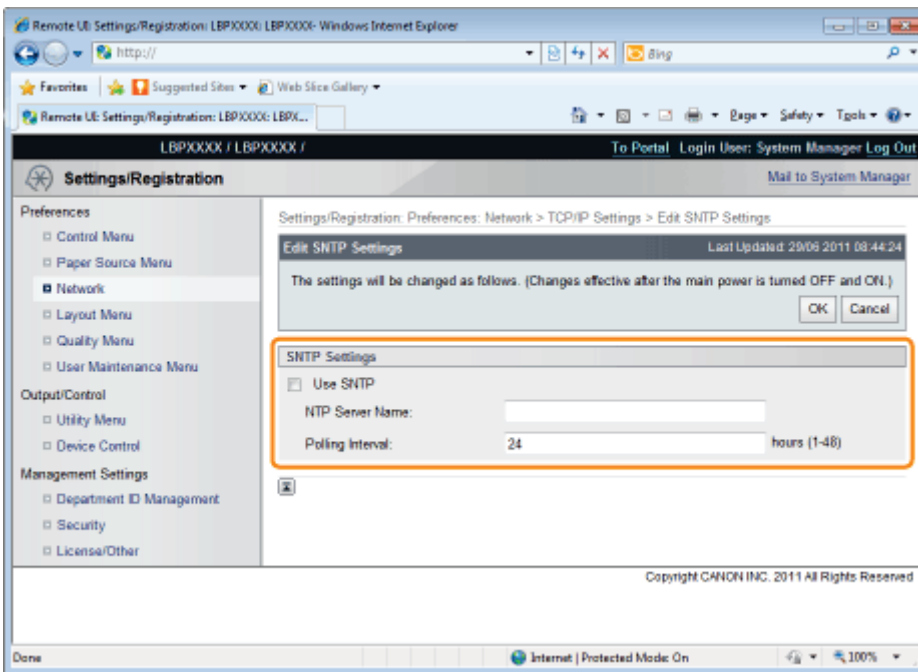

When using the SNTP client function to obtain time information from the NTP server
 Select the [Use SNTP] check box, and set the following items.

[NTP Server Name]	If DNS is set, enter the server name of the NTP server in [NTP Server Name]. If DNS is not set, enter the IP address of the NTP server in [NTP Server Name].
[Polling Interval]	Set the interval for the printer to poll the NTP server for time information. You can set intervals of [1] to [48] (hours).

NOTE
NTP Server
 It is a public time information server on the Internet.

When not Using the SNTP Client Function
 Clear the [Use SNTP] check box.

(3) Click [OK].

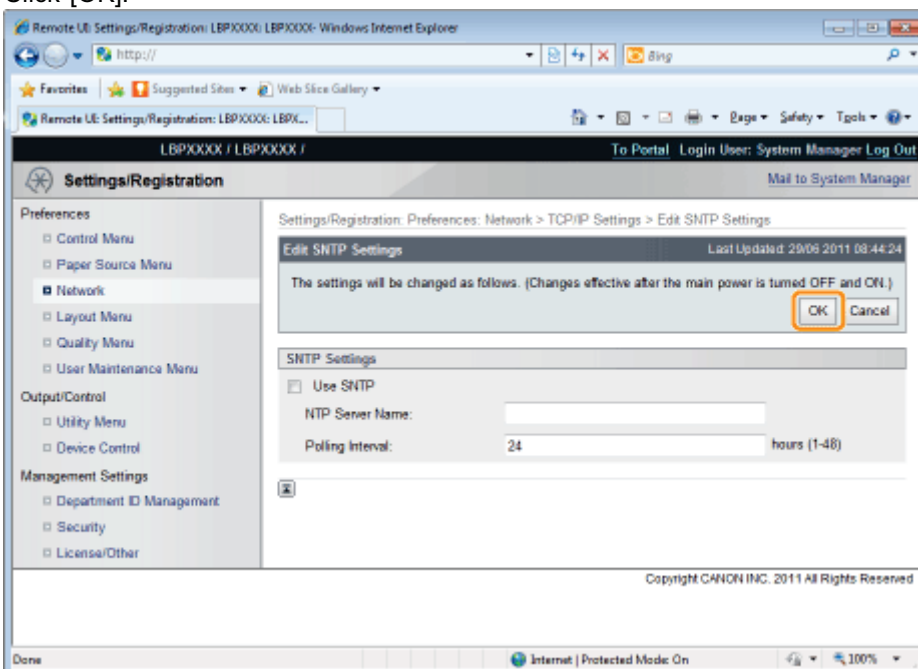

Proceed to Step 6 if you do not specify the settings for the other options.

Department ID Management PIN Configuration Settings (LBP6680x Only)

Specifies whether the department ID and password should be confirmed before printing using the XPS printer driver.

(1) Click [Edit...] in [Department ID Management PIN Confirmation Settings].

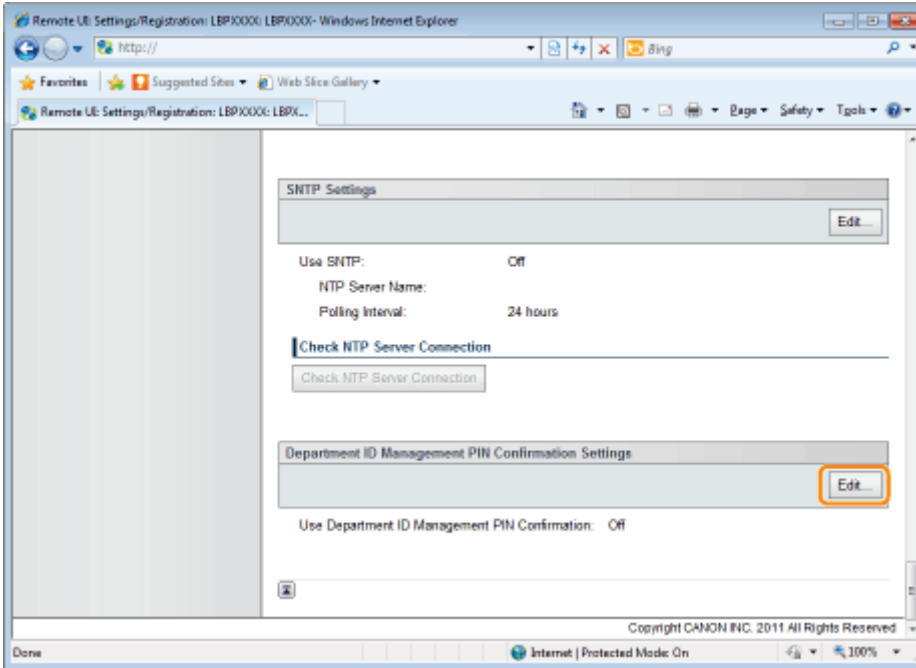

(2) Set the Department ID Management PIN Confirmation function.

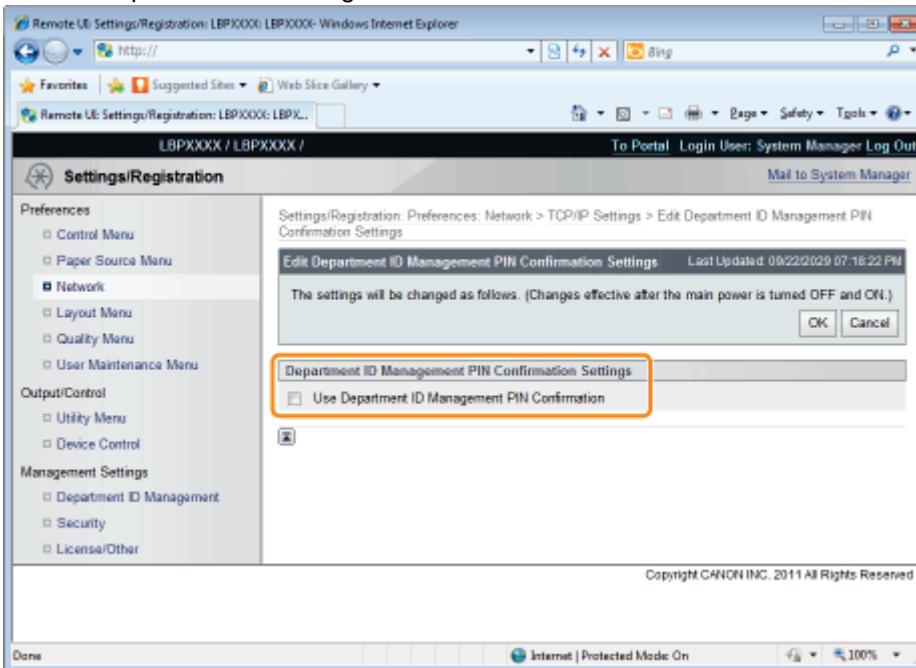

IMPORTANT

To use this function, you need to enable Department ID Management in advance.

- A key pair to use for encrypted SSL communication is required to confirm Department IDs and passwords. Even if you enable [Use Department ID Management PIN Confirmation], Department IDs and passwords cannot be confirmed if the key pair is corrupted or invalid. In this case, erase the key pair and see "[Setting Keys and Certificates](#)" to register a new key pair.
- If there is no key pair, you cannot enable [Use Department ID Management PIN Confirmation]. You can use the preinstalled key pair, or generate an original key pair with the printer, to set as the default key. For information on the default key, and instructions on how to generate an original key, see "[Setting Keys and Certificates](#)."

(3) Click [OK].

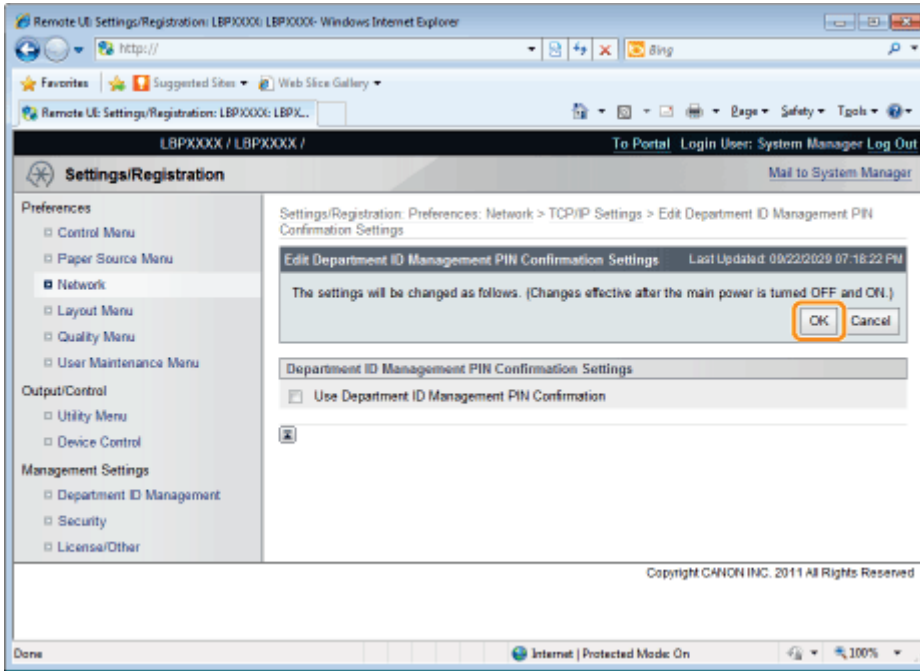

Proceed to Step 6 if you do not specify the settings for the other options.

6

Perform a hard reset or restart the printer.

→ After performing a hard reset or restarting the printer, the settings are effective.

NOTE

To perform a hard reset

You can perform a hard reset using the following procedure.

1. Click [Settings/Registration].
2. Select [Device Control] from the [Output/Control] menu.
3. Select [Hard Reset], and then click [Execute].

Attention (Protocol Settings)

04L9-08L

When setting the IP address

NOTE

If you changed the IP address after installing the printer driver

Specify the port to be used again in the printer driver.

- ["Configuring a Computer that Performs Printing"](#)

When using DHCP, BOOTP, or RARP

- One of the following can be used: DHCP, BOOTP, or RARP. When any of the settings is turned [On], the remaining two settings are automatically turned [Off].
- Because it takes one to two minutes to check whether DHCP, BOOTP, and RARP are available, we recommend that you set the unused protocol(s) to [Off].
- Each server or daemon (the DHCP server, BOOTP daemon, or RARP daemon) must be running on the network.
- Even if you are using DHCP, BOOTP, or RARP, specify the settings for [IP Address], [Subnet Mask], and [Gateway Address] manually. If you cannot obtain information from the servers of DHCP, BOOTP, and RARP, the values specified manually are used.
- After the printer restarts, the values obtained from DHCP, BOOTP, and RARP are displayed. (If the values have been specified previously, they overwrite the obtained ones.)

When using DHCP

If you cycle the power of the printer, you may not be able to print. This is because a different IP address from the one that has been used is assigned.

When using DHCP, consult your network administrator and perform either of the following settings.

- Specifying the DNS Dynamic Update function
- Specifying the settings so that the same IP address is always assigned when the printer starts up

When configuring the DNS Settings

IMPORTANT

DNS Dynamic Update

DNS Dynamic Update is a function that adds the IP address of the device and the names specified as the host name and domain name to the DNS server automatically.

This function can be used in the environment in which a Dynamic DNS server is being used.

When using the DNS Dynamic Update function

You need to set the IP address, host name, and domain name of the DNS server.

When configuring the WINS Settings

IMPORTANT

WINS

WINS (Windows Internet Name Service) is a service that maps NetBIOS names (names of computers or printers) to IP addresses. A WINS server is required to use WINS.

If [Scope ID] is specified

The printer cannot communicate with the computers that have a different scope ID.

When configuring the Multicast Discovery Settings

NOTE

Multicast discovery

This is a function that searches for certain devices using Service Location Protocol (SLP).

By using the multicast discovery function, you can search for only the devices whose values in [Scope Name] are verified, using the service location protocol (SLP) from utility software, such as NetSpot Device Installer.

When configuring the SNTP Settings

NOTE

When the check box for [Use SNTP] is selected

[Check NTP Server Connection] is displayed on the [TCP/IP Settings] page on the [Network]. When [Check NTP Server Connection] is clicked, the printer communicates with the specified NTP server, and the result of the communication is displayed in [NTP Server Connection Check Result].

[OK] is displayed if the printer communicated with the NTP server successfully, and [Error] is displayed if the printer could not communicate with the NTP server due to any reason such as a setting mistake or communication error.

Setting IP v. 6

04L9-08R

This section describes the procedure for setting IP v. 6.

Specify the settings for IP v. 6 using the Remote UI after specifying the settings for IP v. 4.

IMPORTANT

- IPSec encryption (Security Architecture for Internet Protocol) is not supported for LBP6670dn.

NOTE

About the IP v. 6 address

This printer can have up to seven IP v. 6 addresses of the following types. (Only one address can be registered manually.) IP v. 6 communication allows you to use multiple IP v. 6 addresses simultaneously.

Type	Registrable Number	Overview
Link-Local Address	1	A link local address is an IPv6 address that is generated automatically using the specific prefix (information indicating to which network the machine belongs) "fe80::" and an interface identifier generated from the MAC address of the printer. Because this address is valid only within the same prefix, it cannot traverse the router. One link-local address is specified for this printer whenever IP v. 6 is being used.
Manual Address	0 to 1	A manual address is a fixed address entered manually. By setting the IP address manually, you can specify the prefix length and the default router address.
Stateless Address	0 to 4	A stateless address is a temporary IPv6 address that is automatically generated using the prefix included in the RA (Router Advertisement) that is notified from the router and the printer's MAC address. If the created IPv6 addresses do not overlap on the network, they may be allocated as the printer's IP address.
Stateful Address	0 to 1	You can obtain a stateful address from the DHCP server using DHCP v. 6.

1

Start the Remote UI, and then log in as Administrator.

 "Starting the Remote UI"

2

Click [Settings/Registration].

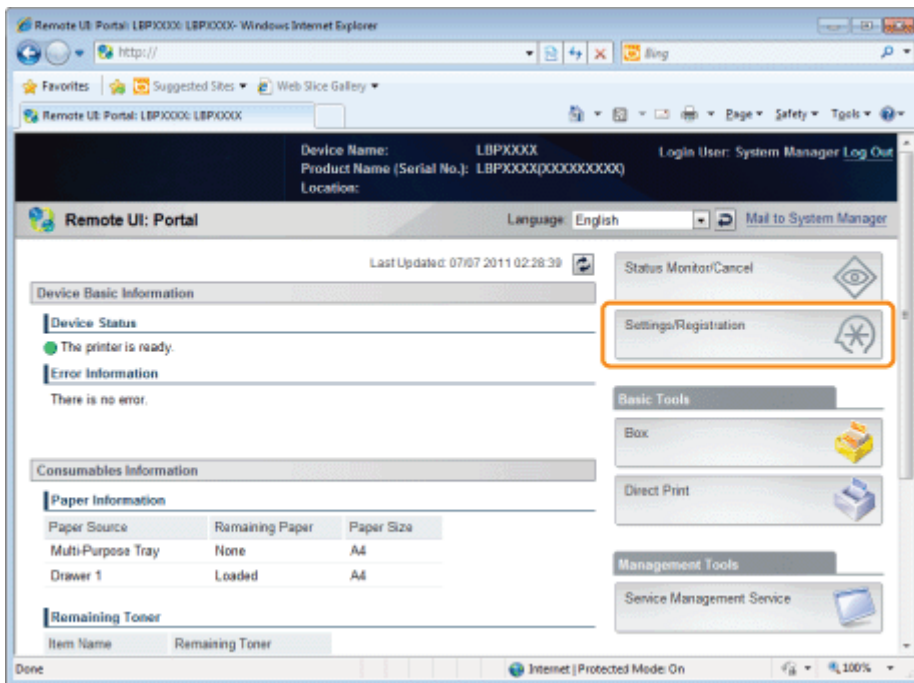

3

Select **[Network]** from the **[Preferences]** menu.

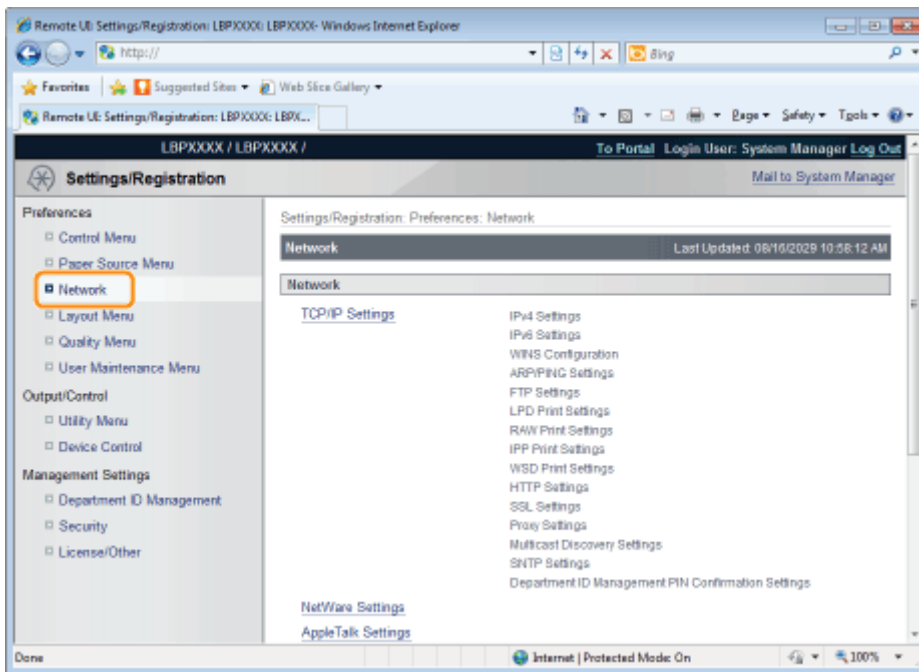

4

Click **[TCP/IP Settings]**.

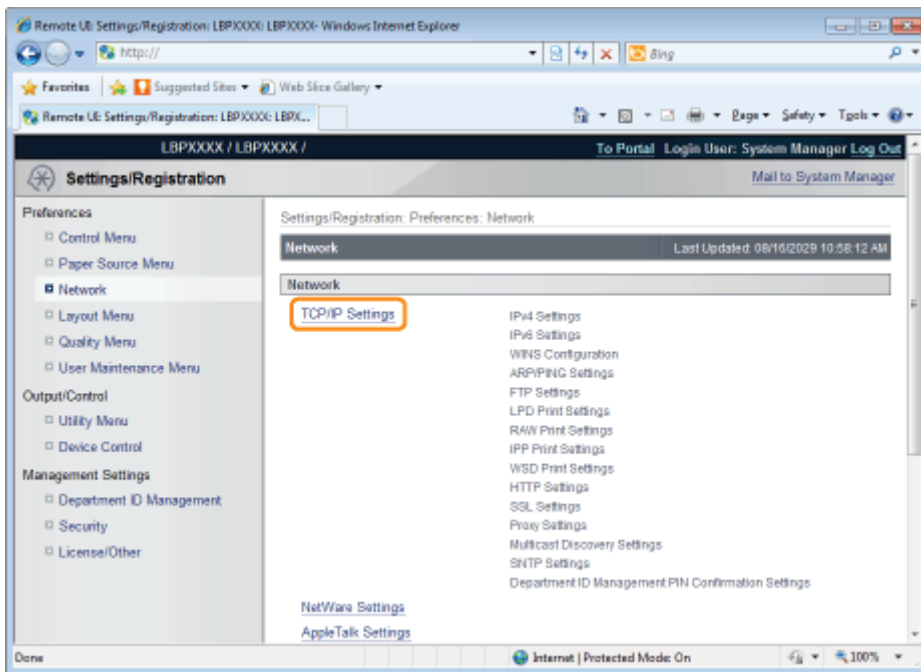

5

Click [Edit...] under [IPv6 Settings].

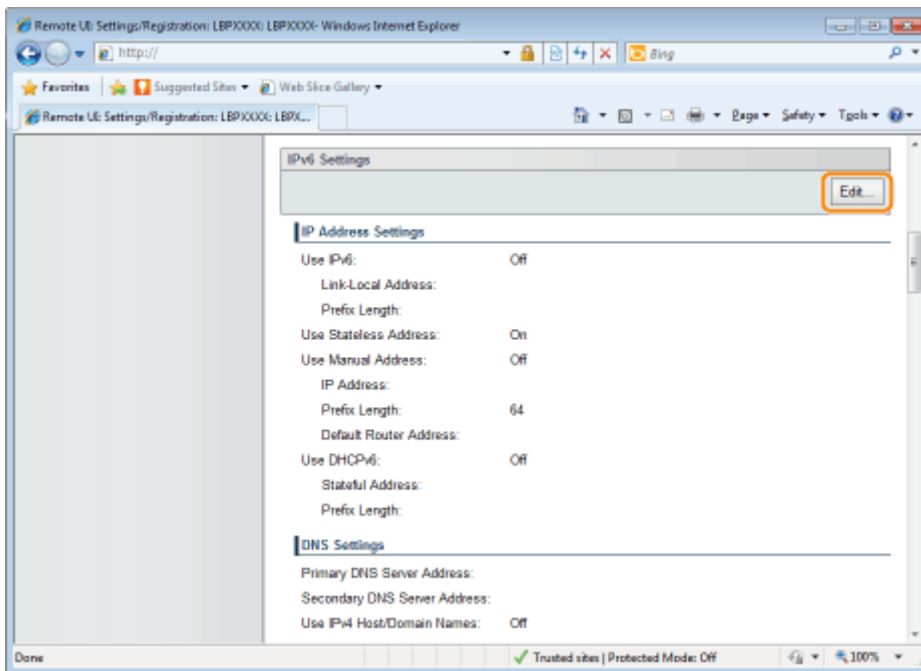

6

Select the [Use IPv6] check box.

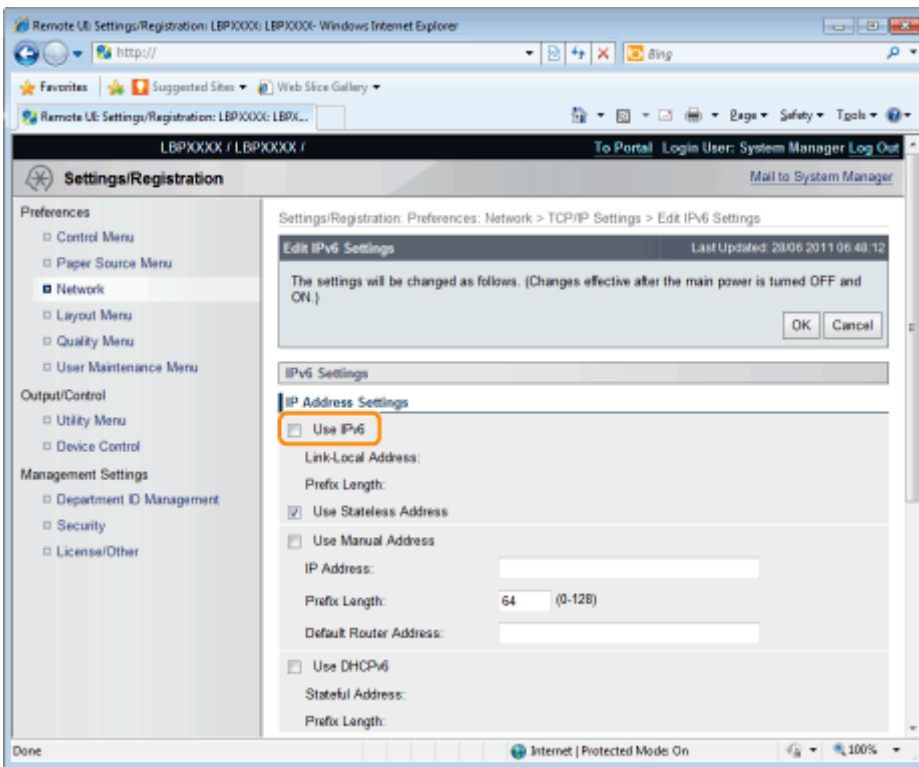

7

Specify the stateless address.

Check the [Use Stateless Address] check box when using a stateless address.

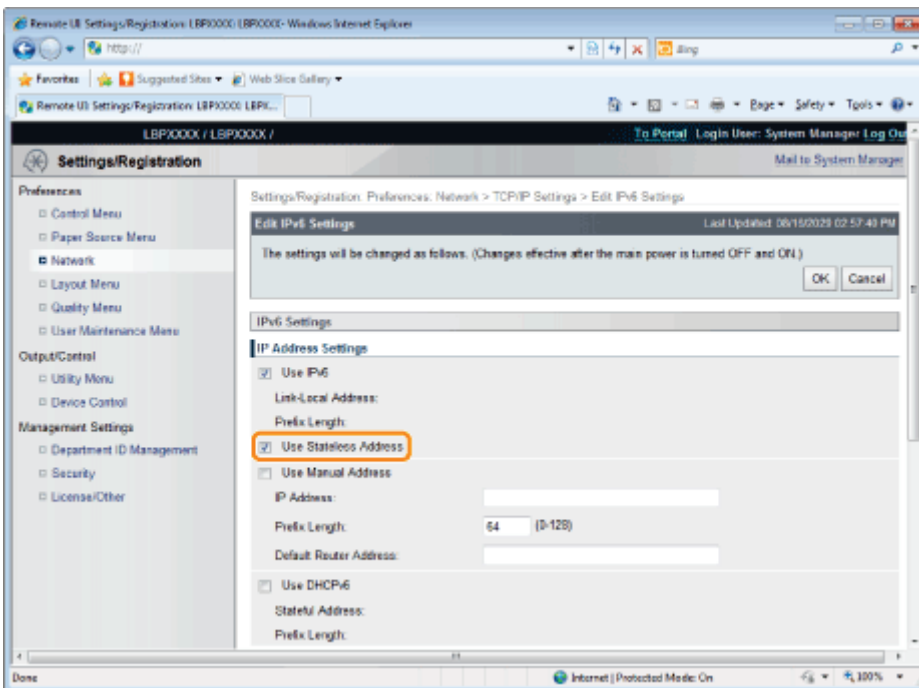

NOTE

Stateless Address Retention

After the [Use Stateless Address] check box is selected and the printer is restarted, the stateless address is displayed automatically. This stateless address is discarded when the printer is turned OFF.

8

If you want to use a manual address, specify the following settings.

If you do not want to use a manual address, proceed to Step 9.

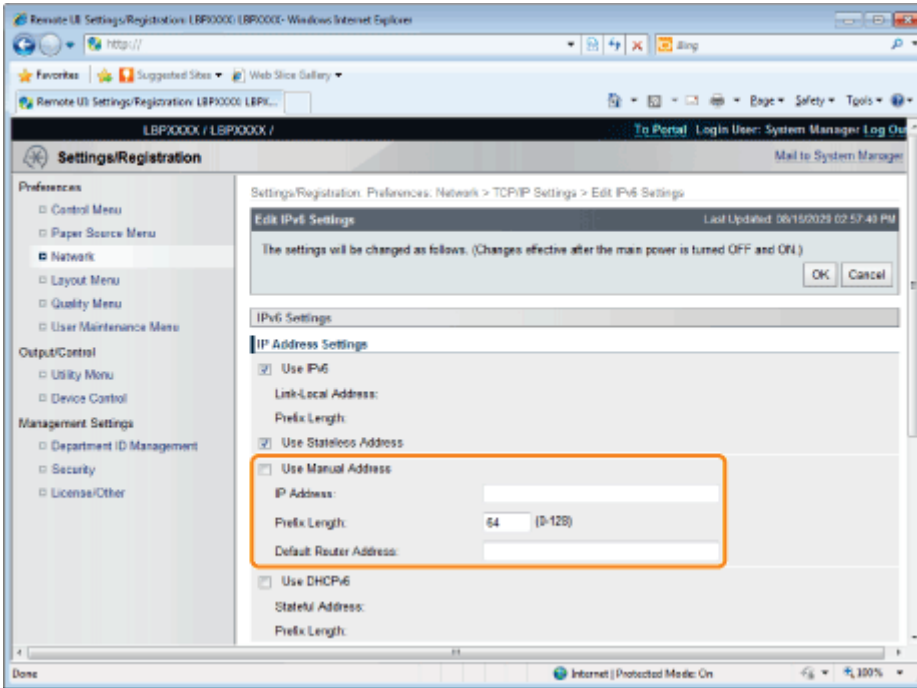

- (1) Select the [Use Manual Address] check box.
- (2) Enter [IP Address].
- (3) Enter [Prefix Length].
- (4) Enter [Default Router Address] as needed.

IMPORTANT

Addresses which cannot be entered in [IP Address] and [Default Router Address]

- An address which starts with "ff" (multicast address)
- An address which starts with "0:0:"

9

Specify DHCP v. 6.

When using the stateful address, select the [Use DHCPv6] check box.

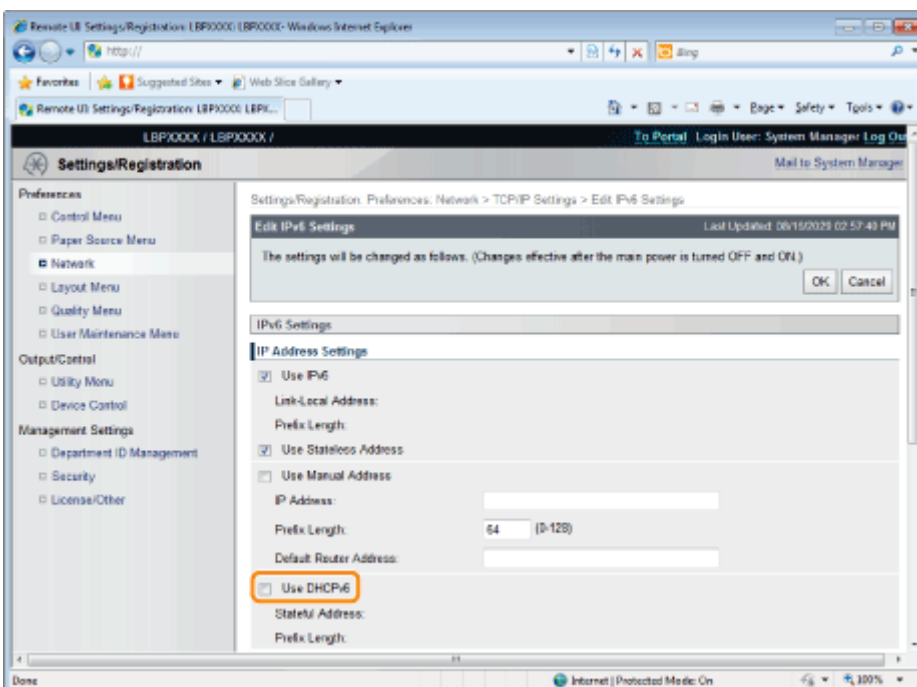

10

If you want to use the DNS server, specify the following settings.

If you do not want to use the DNS server, proceed to Step 11.

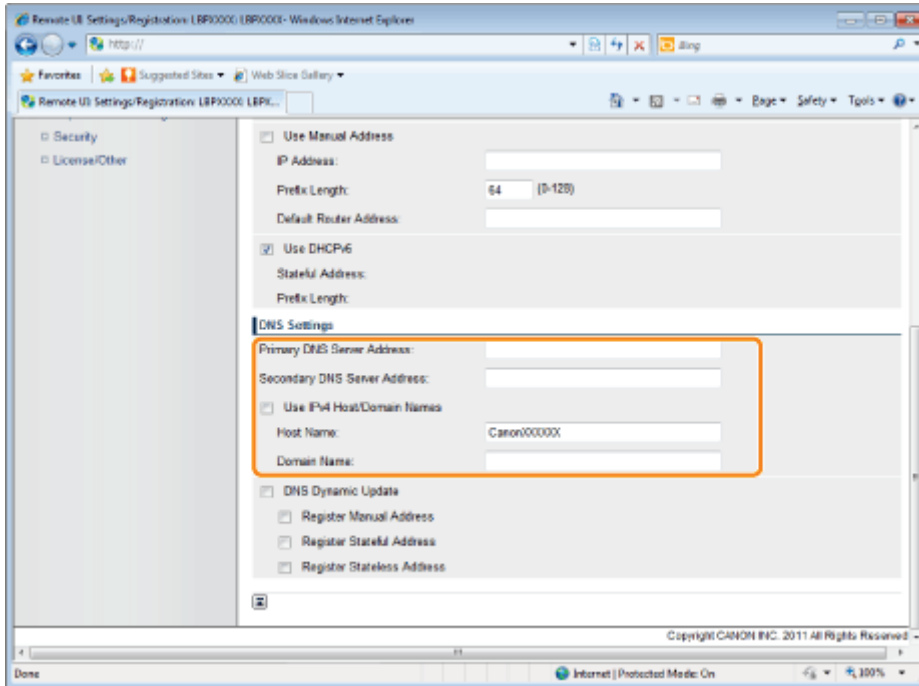

You can specify the following [DNS Settings].

- (1) Enter the IP address of the primary DNS server in [Primary DNS Server Address].
- (2) Enter the IP address of the secondary DNS server in [Secondary DNS Server Address].
- (3) Set [Host Name] and [Domain Name].
 - Select the [Use IPv4 Host/Domain Names] check box to use the same host name and domain name as IPv4. After the printer is restarted, the host name and domain name set by IPv4 are set automatically.
 - When using a host name and domain name that are different from IPv4, enter [Host Name] and [Domain Name]. You can enter up to 47 alphanumeric characters.

```
Example of [Domain Name] entry: "example.com"
```

11

If you want to use DNS Dynamic Update, specify the following settings.

If you do not want to use the DNS server, proceed to Step 12.

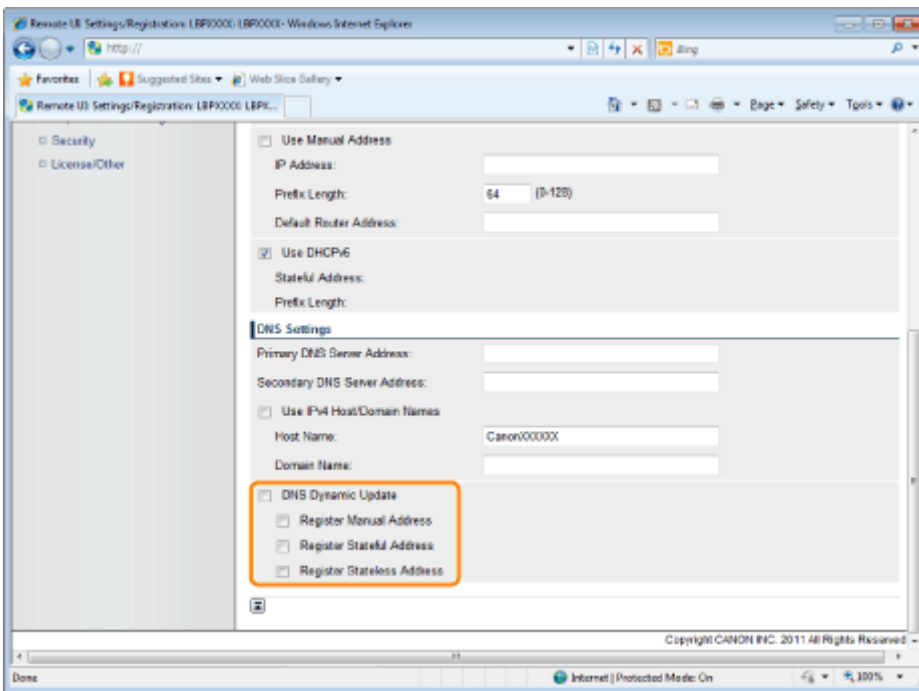

(1) Select the [DNS Dynamic Update] check box.

† Using the DNS Dynamic Update function, by registering the [Host Name] and [Domain Name] to the DNS server, the printer's IP address can be used without being fixed.

(2) Set whether to register the IPv6 address to the DNS server during DNS dynamic updates.

- If you select the [Register Manual Address] check box, a manual address is registered to the DNS server.
- If you select the [Register Stateful Address] check box, a stateful address is registered to the DNS server.
- If you select the [Register Stateless Address] check box, a stateless address is registered to the DNS server.

IMPORTANT

DNS Dynamic Update

DNS Dynamic Update is a function that adds the IP address of the device and the names specified as the host name and domain name to the DNS server automatically.

This function can be used in the environment in which a Dynamic DNS server is being used.

When using the DNS Dynamic Update function

You need to set the IP address, host name, and domain name of the DNS server.

12

Click [OK].

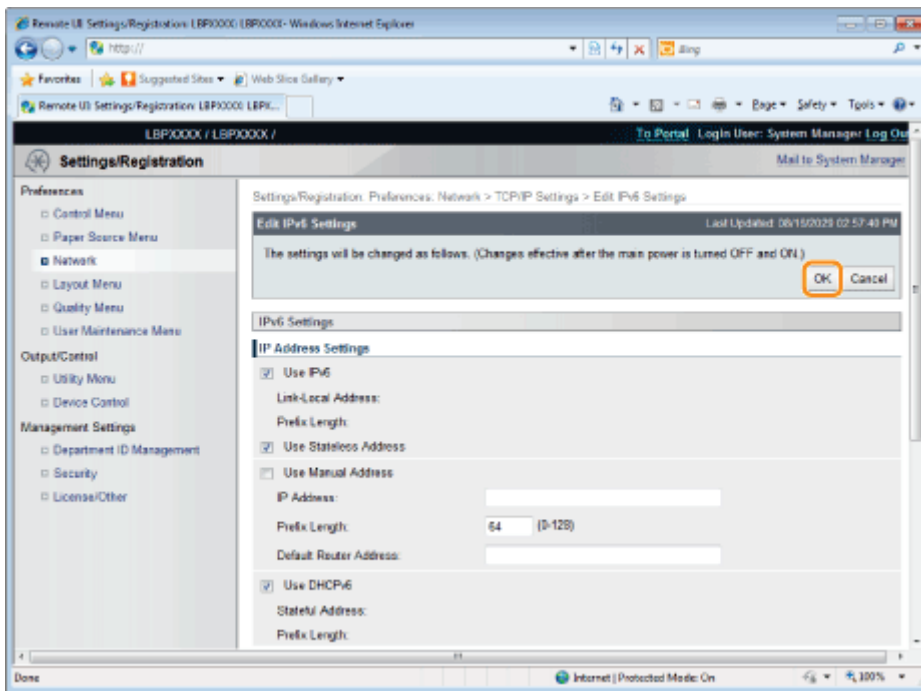

13

Perform a hard reset or restart the printer.

→ After performing a hard reset or restarting the printer, the settings are effective.

NOTE

To perform a hard reset

You can perform a hard reset using the following procedure.

1. Click [Settings/Registration].
2. Select [Device Control] from the [Output/Control] menu.
3. Select [Hard Reset], and then click [Execute].

Configuring a Computer that Performs Printing

04L9-085

After completing the protocol settings for the printer, configure each computer to be used for printing.

- † This section describes the procedure for when you are using Windows. If you are using Macintosh, see "[Configuring a Computer that Performs Printing](#)" in "[Network Settings for the Printer \(AppleTalk\)](#)."

Connecting to a TCP/IP Network

Install TCP/IP client software on all the computers to be used for printing to make them able to use a TCP/IP network. For more details, see the instruction manual for the operating system.

Print Application Selection

This printer supports the following print applications when being used on a TCP/IP network.

- LPD
- RAW
- IPP/IPPS
- FTP
- WSD

NOTE

Print application

A print application is software that receives print data sent via a network and outputs the data to the printer. A print application is required to print to the printer on a network.

About the printer connection

The setting procedure for the printer connection varies depending on the print application. Perform the settings for the printer connection after installing the printer driver.

- For details on the features of print applications, see the following.
 - ["Features of LPD"](#)
 - ["Features of RAW"](#)
 - ["Features of IPP/IPPS"](#)
 - ["Features of WSD"](#)
- For details on the procedure for configuring a print application, see the following.
 - ["Connecting the Printer \(LPD/RAW\)"](#)
 - ["Connecting the Printer \(IPP/IPPS\)"](#)
 - ["Connecting the Printer \(WSD\)"](#)

NOTE

When using FTP Client

You can print using FTP client software.

For details on the procedure for printing using FTP client software, see "[FTP Client](#)."

To manage the printer effectively

You can manage the printer effectively as follows by specifying Windows on the network as the print server.

The print server manages print data.

If you install an alternative printer driver previously, other computers can install the printer driver via the network.

For details on the procedure for configuring the print server, see "[Printer Driver Installation Guide](#)."

- † For details on the procedure for viewing "[Printer Driver Installation Guide](#)", see "[Installation](#)."

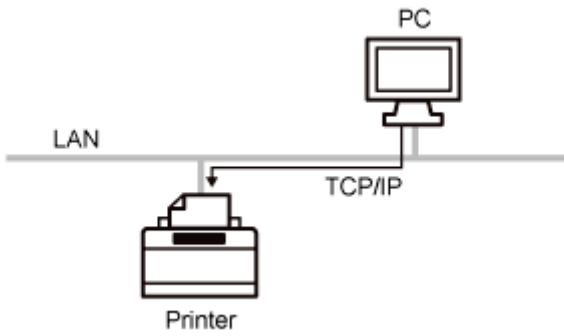

This is a print application that can be used on Windows, Mac OS X, UNIX, and Linux.

LPD is generally used for a TCP/IP network environment.

Advantages	<ul style="list-style-type: none">• LPD printing is the most common network printing method supported by Windows, Mac OS X, UNIX, and Linux as standard.• You can also print a banner page.• Even if you should restart the printer while the printer is printing, the print data is guaranteed because the print job is retransmitted (when a byte count is specified on printing).
Disadvantage	<ul style="list-style-type: none">• You cannot obtain the detailed information about print jobs.
Usage Example	<ul style="list-style-type: none">• When sharing the printer by multiple users (because it is easy to identify the owner of the print data by using the banner page)• When there are a variety of computers (operating systems) in the same network environment, and you want to print using only one print application
Setting Method	<ul style="list-style-type: none">• "Connecting the Printer (LPD/RAW)"

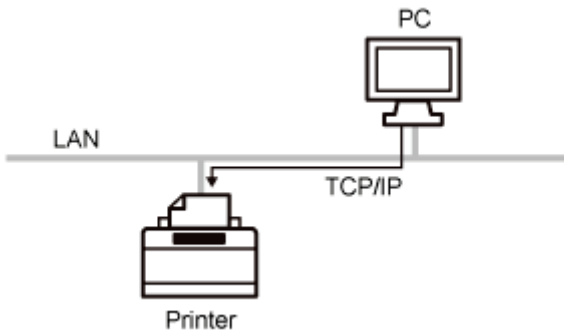

This is a print application that can be used on Windows.

By using this printer application, you can generally print faster than when using LPD.

Advantages	<ul style="list-style-type: none">• You can print relatively faster than when using other applications.• When printing in Windows, the print settings using RAW are easier than using other print applications.
Disadvantage	<ul style="list-style-type: none">• You cannot obtain the detailed information about print jobs.• RAW is supported as standard by only Windows, not supported by Macintosh, UNIX, and Linux.
Usage Example	<ul style="list-style-type: none">• If you are using Windows and want to use the printer immediately after installing it
Setting Method	<ul style="list-style-type: none">• "Connecting the Printer (LPD/RAW)"

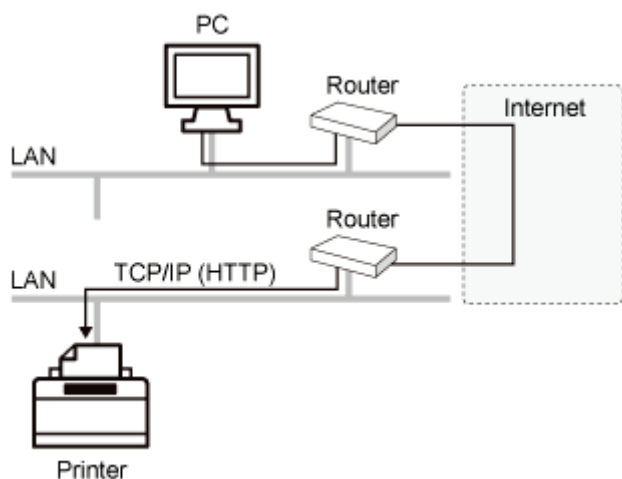

IPP is a print application that can be used on Windows etc. By using this print application, you can print not only to a printer on your LAN, but also to a remote printer via the Internet.

IPPS is a print application that performs SSL encrypted communication when using IPP. IPPS can be used on Windows when the SSL encrypted communication function is enabled.

Advantages	<ul style="list-style-type: none">• You can print using the printer on the Internet.• You can obtain information about print jobs and the printer.
Disadvantage	<ul style="list-style-type: none">• Printing takes relatively more time than other print applications do.
Usage Example	<ul style="list-style-type: none">• When printing using a remote printer via the Internet
Setting Method	➤ "Connecting the Printer (IPP/IPPS)"

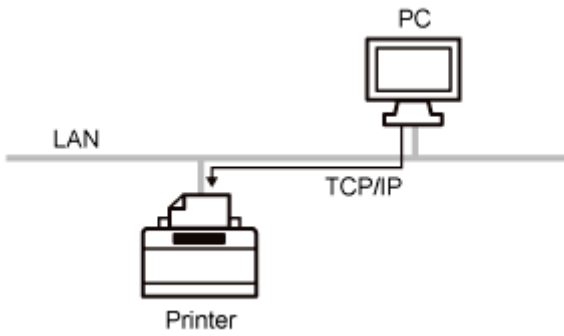

This is a print application that can be used on Windows Vista, 7, and Server 2008. By using WSD, you can search for the printer automatically as well as obtain information about jobs and the printer, using the WSD protocol.

Advantages	<ul style="list-style-type: none">• You can search printers on a network automatically.• Installation of the printer driver is easy.• WSD can notify the computer of job completion and obtain the printer's configuration information automatically.
Disadvantage	<ul style="list-style-type: none">• Windows Vista, 7, and Server 2008 are only operating systems that support WSD.
Usage Example	<ul style="list-style-type: none">• If you are using Windows Vista, 7 or Server 2008 and want to use the printer immediately after installing it
Setting Method	➤ "Connecting the Printer (WSD)"

Connecting the Printer (LPD/RAW)

04L9-090

Configure the protocol settings.

- ❖ If You Are Using Windows
- ❖ If You Are Using UNIX

If You Are Using Windows

When Installing the Printer Driver from the Beginning

1

Install the printer driver.

Following the procedure for automatically searching the printer on a network in "Printer Driver Installation Guide", install the printer driver.

† For details on the procedure for viewing "Printer Driver Installation Guide", see "[Installation](#)."

NOTE

When using LPD

When the printer driver is installed using the above method, RAW is specified as the print application to be used. If you want to use LPD, install the printer driver using the above procedure, and then change a port.

When Changing a Port

1

Open the printer folder.

- ❖ "Basic Operations/Various Information for Windows"

2

Right-click the icon for this printer, and then select [Printer properties] or [Properties] from the pop-up menu.

3

Perform the following procedure.

- (1) Display the [Ports] sheet.
- (2) Click [Add Port].

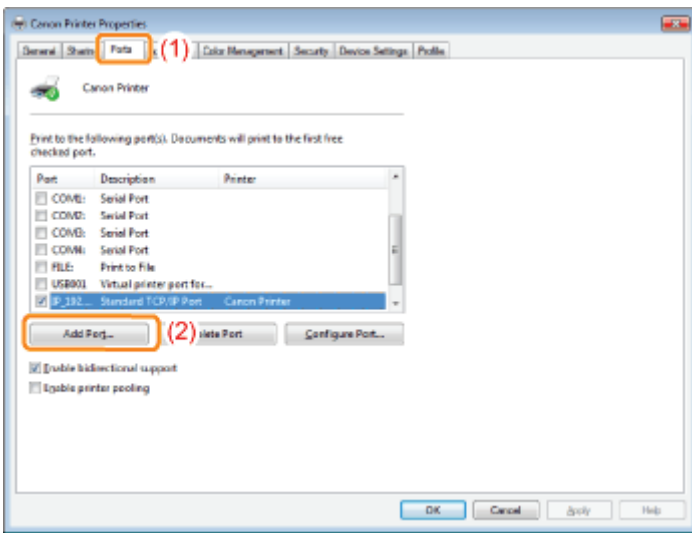

4

Select the port type.

- (1) Select [Standard TCP/IP Port].
- (2) Click [New Port].

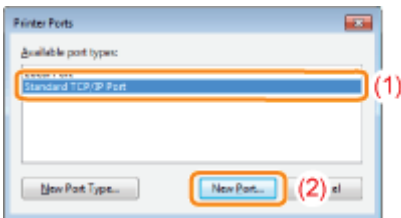

5

Click [Next].

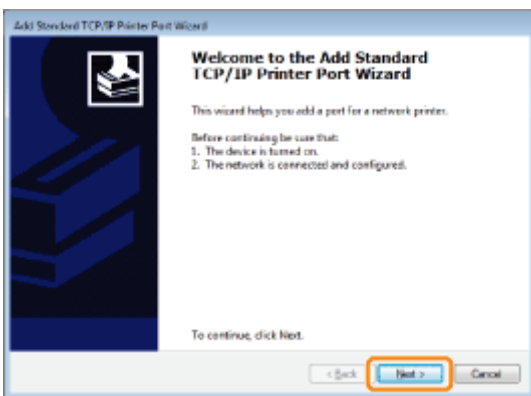

6

Enter the IP address or name of the printer.

- (1) Enter the IP address or name* of the printer in [Printer Name or IP Address].

* The DNS name to be registered on the DNS server (up to 78 characters)

- (2) Click [Next].

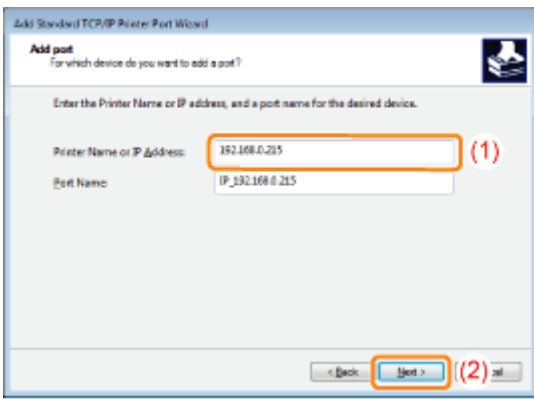

IMPORTANT

If the printer cannot be detected

The following screen appears. Perform either of the following operations.

- Follow the on-screen instructions and search again for the printer.
- Specify the setting for [Device Type].

(1) Select [Standard], and then select [Canon Network Printing Device with P9100].

(2) Click [Next].

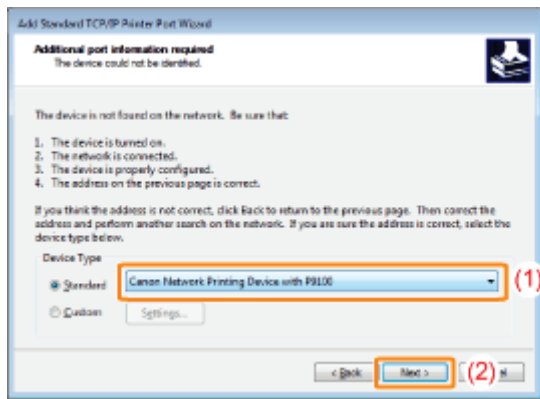

NOTE

If you are not sure about the value to enter

The value to be entered varies depending on how the IP address of the printer was set. For more details, see "[Values for Setting a Port](#)" or ask your network administrator.

7

Click [Finish].

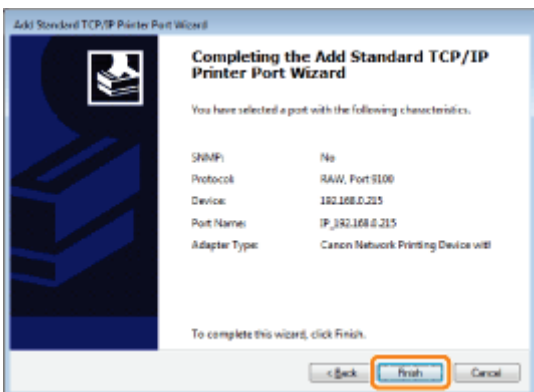

8

Click [Close].

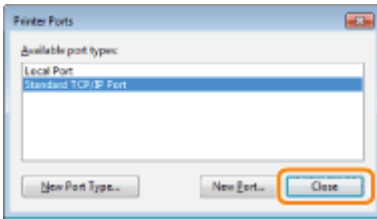

9

Click [Apply].

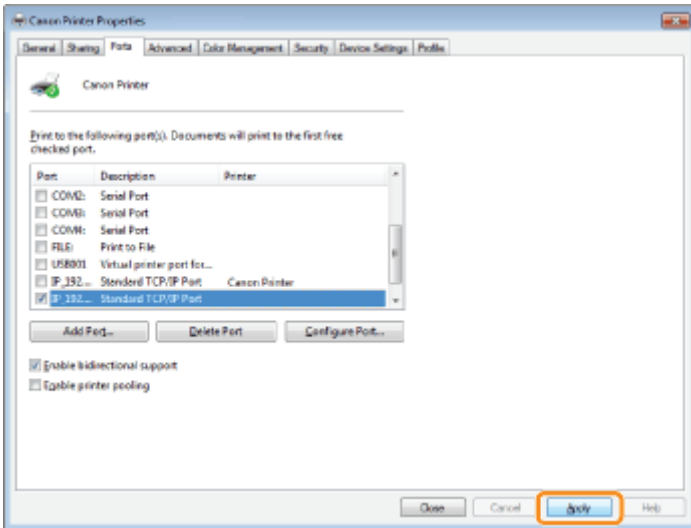

If you want to use LPD, proceed to Step 10.

If you want to use RAW, proceed to Step 11.

10

If you want to use LPD, change the port configuration information.

When using LPD printing, set up the LPR protocol using the procedure below.

(1) Click [Configure Port].

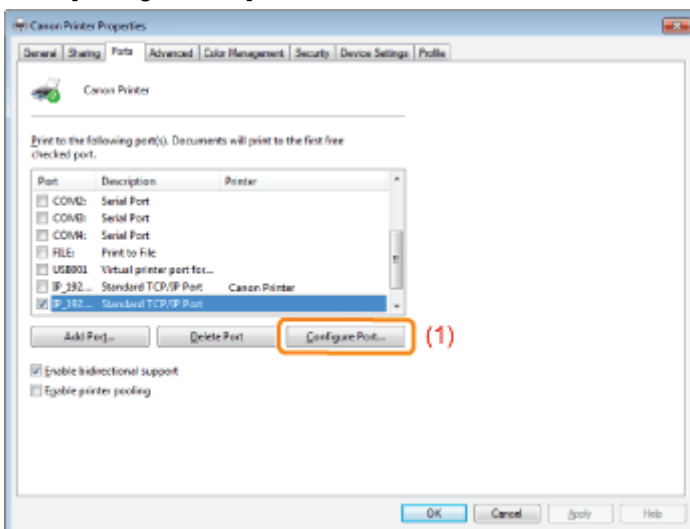

(2) Select [LPR].

(3) Enter "lp" in [Queue Name].

(4) Click [OK].

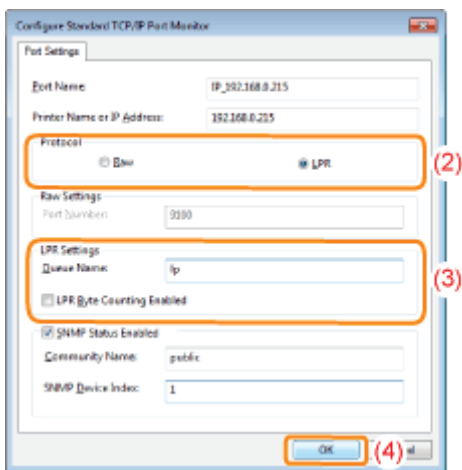

11

Click [OK].

NOTE

When deleting an unnecessary port

Select the unnecessary port on the [Ports] sheet, and then click [Delete Port].

If You Are Using UNIX

This section describes the preparation for printing using LPD. For details on the procedure for printing using FTP, see "FTP Client."

IMPORTANT

About the setting procedure

- The procedure described here is a setting example. Depending on the system environment, the setting procedure may be different.
- Specify the settings also when using a computer on which UNIX OS is installed as a stand-alone workstation along the procedure described here.

1

Log in to the UNIX server as a root user.

IMPORTANT

If you do not have the root user permission on the UNIX server

Consult your network administrator.

2

Edit the "/etc/hosts" file to add the printer to the local network.

1. Open the "/etc/hosts" file using a text editor.

2. Add the following line.

- **Form:** <The fixed IP address of the printer> (a tab) <the printer name> (a tab) # <comment>
- **Input Example:** 192.168.0.215 LBP6680x/LBP6670dn #the printer to be added

- † If you specified [DNS Host Name] of the printer, specify the same character string as [DNS Host Name] in <the printer name>.
For more details on [DNS Host Name], see "[Configuring the Protocol Settings.](#)"

3. After saving the "/etc/hosts" file, exit the text editor.

IMPORTANT

Be sure to assign a fixed IP address to the printer.

When printing from UNIX OS, be sure to assign a fixed IP address to the printer. For details on the procedure for setting the IP address, see "[Setting the IP Address \(IP v. 4\).](#)"

3

Set up the spooling system on the UNIX server.

- ❖ [Example of When Using Solaris 1.x](#)
- ❖ [Example of When Using Solaris 2.x or Later](#)
- ❖ [Example of When Using HP-UX](#)
- ❖ [Example of When Using IBM-AIX](#)

Example of When Using Solaris 1.x

1. Enter the following in the "/etc/printcap" file.

- **Form:**

```
:<Print queue name>|<comment>:\
:lp=<the device special file>:\
:sd=<the spool directory>:\
:if=<the log file directory>:\
:rm=<the IP address or name of the printer>
```
- **Input Example:**

```
:print_queue_name|comments:\
:lp=/var/spool/print_queue_name/.null:\
:sd=/var/spool/print_queue_name:\
:if=/var/spool/print_queue_name/log:\
:rm=printer_host_name
```

† In the line of "rm", enter the same contents that you entered in <the printer name>.

2. Create the spool directory for the printer. Execute the following commands.

- **Form:**

```
mkdir -p <the spool directory>
chown daemon <the spool directory>
```
- **Input Example:**

```
mkdir -p /var/spool/print_queue_name
chown daemon /var/spool/print_queue_name
```

† In <the spool directory>, enter the same character string that you added in the "/etc/printcap" file.

3. Create the log file for the printer. Execute the following commands.

- **Form:**

```
cp /dev/null <the log file directory>
```
- **Input Example:**

```
cp /dev/null /var/spool/print_queue_name/log
```

4. Proceed to Step 4.

Example of When Using Solaris 2.x or Later

1. Run "admintool."

† The "admintool" utility is supplied with an operating system. For more details, see the manual for the operating system.

2. Select **[Browse]** → **[Printers]**.
3. Select **[Edit]** → **[Add]** → **[Access to Printer]**.
4. Enter an arbitrary print queue name in **[Printer Name]**, and then enter the IP address or name of the printer in **[Print Server]**.
5. Select **[OK]**.
6. Proceed to Step 4.

Example of When Using HP-UX

1. Run "SAM."

† The "SAM" utility is supplied with an operating system. For more details, see the manual for the operating system.

2. Select **[Printers and Plotters]**.
3. Select **[LP Spooler]** from the **[Printers and Plotters]** menu.
4. Select **[Printers and Plotter]** from the **[LP Spooler]** menu.
5. Select **[Add Remote Printer/Plotter]** from the **[Action]** menu.
6. Enter an arbitrary print queue name in **[Printer Name]**, and then enter the IP address or name of the printer in **[Remote System Name]**.
7. Enter "lp" in **[Remote Printer Name]**.
8. Select **[Remote Printer is on a BSD System]**.
9. Select **[OK]**.
10. Proceed to Step 4.

Example of When Using IBM-AIX

1. Run "SMIT."

† The "SMIT" utility is supplied with an operating system. For more details, see the manual for the operating system.

2. Select **[Print Spooling]** → **[Add a Printer Queue]** → **[remote]**.
3. Select **[Standard processing]**.
4. Enter an arbitrary print queue name in **[remote queue name]** and the IP address or name of the printer in **[Hostname of Remote Server]**.
5. Enter "lp" in **[name of the queue]** on the remote server.
6. Enter "BSD" in **[type of print spooler]** on the remote server.
7. Proceed to Step 4.

4

Enter the following commands and check if you can print.

- **Form:** `lp -d <the print queue name> <the name of the file to be printed>`
- **Input Example:** `lp -d print_queue_name report`

Values for Setting a Port

04L9-091

Depending on the method for setting the IP address of the printer, the value to be entered in [Printer Name or IP Address] on the following screen displayed in the process of port setting varies.

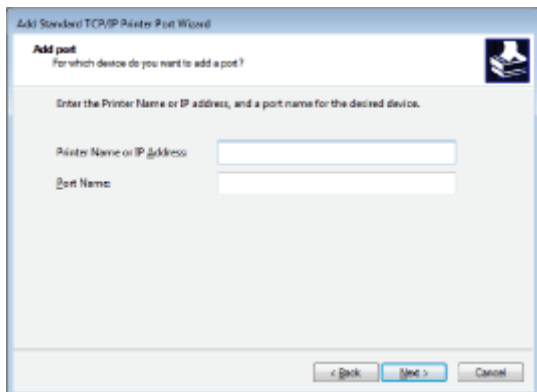

If you want to set the IP address to be assigned to the printer manually (If you know the IP address to use)

- Enter the IP address in [Printer Name or IP Address].
- If you want to set the IP address using the DNS server, specify the DNS settings for the printer. Then, enter the printer name (the DNS name registered on the DNS server) within up to 78 characters in [Printer Name or IP Address]. For example, enter the printer name as "AAA.BBB.com" if you specified the host name as "AAA" and the domain name as "BBB.com." However, enter "AAA.CCC.com" if you can obtain the domain name (CCC.com) simultaneously when you obtain the IP address from DHCP and so on.

If you want to set the IP address to be assigned to the printer using DHCP and so on

- Specify the settings such as the DHCP settings so that the same IP address is always assigned to the printer when you start the printer. For more details, see "If you want to set the IP address to be assigned to the printer manually" above.
- If a different IP address is assigned to the printer each time the printer starts, specify the DNS settings for the printer first. Then, enter the printer name (the DNS name registered on the DNS server) within up to 78 characters in [Printer Name or IP Address]. For example, enter the printer name as "AAA.BBB.com" if you specified the host name as "AAA" and the domain name as "BBB.com." However, enter "AAA.CCC.com" if you can obtain the domain name (CCC.com) simultaneously when you obtain the IP address from DHCP and so on.

NOTE

About the DNS settings

See "[Configuring the Protocol Settings.](#)"

Connecting the Printer (IPP/IPPS)

04L9-092

- If You Are Using Windows Vista, 7 or Server 2008
- If You Are Using Windows 2000, XP, or Server 2003

If You Are Using Windows Vista, 7 or Server 2008

IMPORTANT

When using IPPS printing

You need to obtain the public key for this printer and install it on Windows Vista, 7 or Server 2008. For details on the procedure for obtaining the public key, see "[Obtaining the Public Key for This Printer When Using SSL Encrypted Communication.](#)"

NOTE

About the screenshots

This procedure is described using screenshots from Windows 7.

1

Confirm the setting for [IP Address Filter].

Make sure that the IP address of the computer on which the printer driver is installed is not restricted to print.

- "[Restricting the Users Who Can Print or Perform the Printer Settings](#)"

IMPORTANT

If printing is restricted

You cannot install the printer driver.

If printing is restricted after the installation

If the IP address of the computer on which the printer driver is installed is restricted to perform printing in [Receive/Print Range Setting], you cannot print from the computer.

2

Open the printer folder.

- "[Basic Operations/Various Information for Windows](#)"

3

Click [Add a printer].

4

Click [Add a network, wireless or Bluetooth printer].

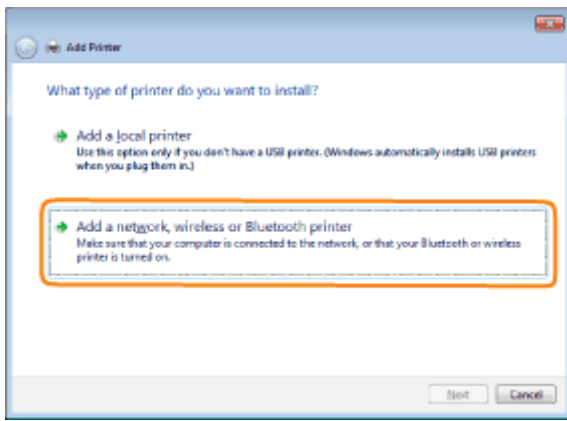

5

Click [The printer that I want isn't listed].

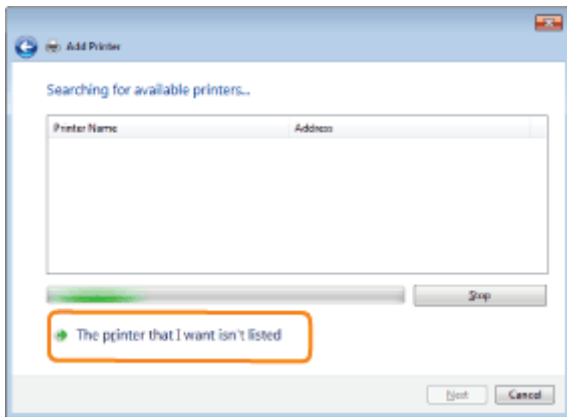

6

Perform the following procedure.

- (1) Select [Select a shared printer by name].
- (2) Enter "http://<the IP address or FQDN of the printer>/ipp."
 - † When you want to perform IPPS printing using SSL encrypted communication, enter "https://<the IP address or FQDN of the printer>/ipp."
- (3) Click [Next].

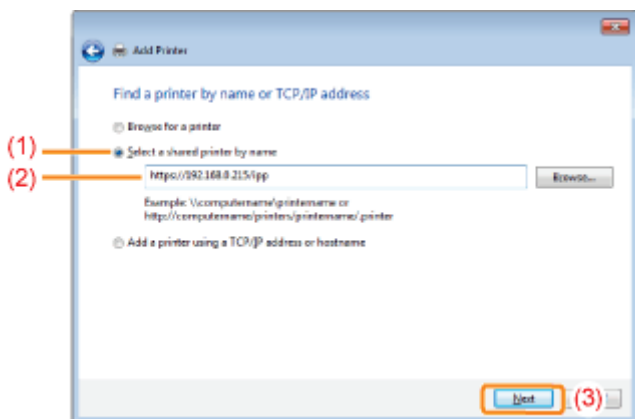

IMPORTANT

About IPPS

IPPS can be used only when the SSL encrypted communication function is enabled.

7

Click **[Have Disk]**, and then specify the folder that contains the printer driver from the CD-ROM drive.

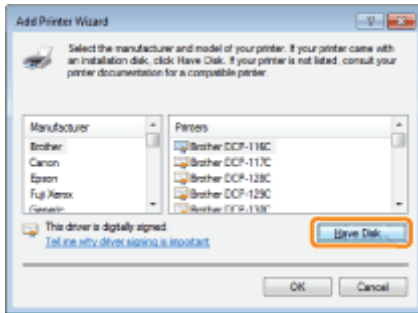

NOTE

When you are using the IPP authentication function

If you are asked to enter the password, enter the user name and password, and then click [OK].

† For details on the settings for the IPP authentication function, see "[Configuring the Protocol Settings.](#)"

8

Follow the on-screen instructions to install the printer driver.

If You Are Using Windows 2000, XP, or Server 2003

1

Confirm the setting for **[Receive/Print Range Setting]**.

Make sure that the IP address of the computer on which the printer driver is installed is not restricted to print.

❖ "[Restricting the Users Who Can Print or Perform the Printer Settings](#)"

NOTE

If printing is restricted

You cannot install the printer driver.

If printing is restricted after the installation

If the IP address of the computer on which the printer driver is installed is restricted to perform printing in **[Receive/Print Range Setting]**, you cannot print from the computer.

2

Open the printer folder.

❖ "[Basic Operations/Various Information for Windows](#)"

3

Display [Add Printer Wizard].

Windows 2000

Double-click [Add Printer].

Windows XP

Click [Add a printer].

Windows Server 2003

Double-click [Add Printer].

4

Click [Next].



5

Select a printer type.

Windows 2000

- (1) Select [Network printer].
- (2) Click [Next].

Windows XP Professional Windows Server 2003

- (1) Select [A network printer, or a printer attached to another computer].
- (2) Click [Next].

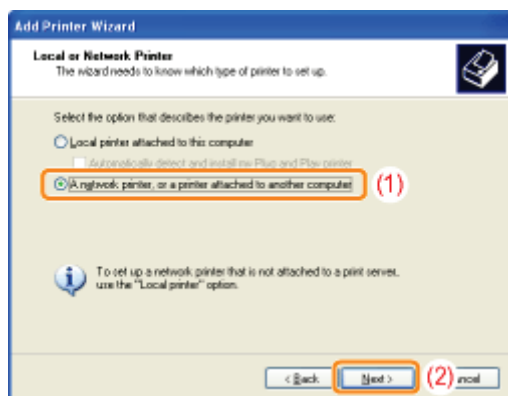

6

Select the printer to be connected.

Windows 2000

Select [Connect to a printer on the Internet or on your intranet].

Windows XP Professional Windows Server 2003

Select [Connect to a printer on the Internet or on a home or office network].

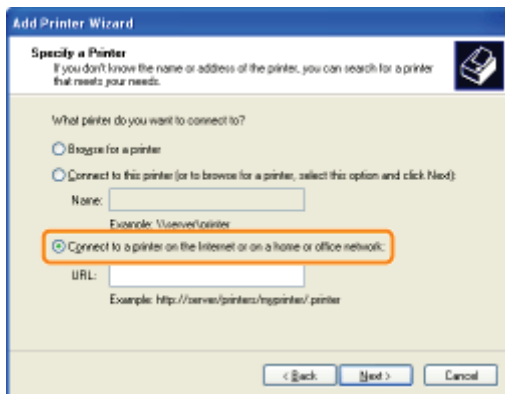

7

Enter [URL].

(1) Enter "http://<the IP address or FQDN of the printer>/ipp."

† When you want to perform IPPS printing using SSL encrypted communication, enter "https://<the IP address or FQDN of the printer>/ipp."

(2) Click [Next].

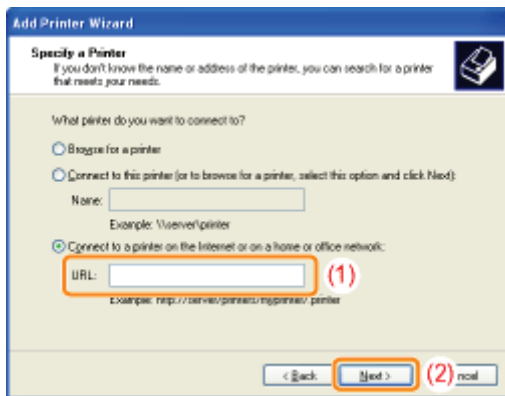

IMPORTANT

About IPPS

IPPS can be used only when the SSL encrypted communication function is enabled.
For details on the SSL encrypted communication function, see "[Setting Keys and Certificates](#)."

8

Click [Have Disk], and then specify the folder that contains the printer driver from the CD-ROM drive.

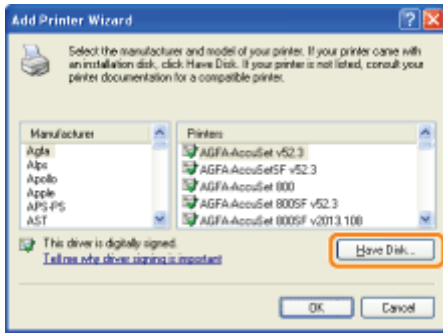

NOTE

When you are using the IPP authentication function

If you are asked to enter the password, enter the user name and password, and then click [OK].

† For details on the settings for the IPP authentication function, see "[Configuring the Protocol Settings.](#)"

9

Follow the on-screen instructions to install the printer driver.

Obtaining the Public Key for This Printer When Using SSL Encrypted Communication

04L9-093

If you want to use IPPS printing, you need to obtain the public key for this printer using the following procedure and install it on Windows Vista, 7 or Server 2008.

1

Start the Web browser.

2

Enter "https://<the IP address or FQDN of the printer>" in the address field, and then press the [ENTER] key on your keyboard.

IMPORTANT

Note on entry of the address

For the IP address or FQDN, enter the same character string as the [Common Name] of the certificate.

[Setting Keys and Certificates](#)

3

Click [Continue to this website (not recommended).] to display the Remote UI screen.

4

Double-click [Internet | Protected Mode] on the lower right of the Web browser.

5

Select [Trusted sites], and then click [Sites].

6

Make sure that "https://<the IP address or FQDN of the printer>" is displayed, and then click [Add] → [Close].

7

If the [Enable Protected Mode (requires restarting Internet Explorer)] check box is selected, clear the check box.

8

Click [OK] to redisplay the Remote UI screen.

9

Exit the Web browser once, and then restart it.

10

Repeat Steps 1 to 3 to start the Remote UI, and then click [Continue to this website (not recommended)].

11

Click [Certificate Error] on the right of the address entry field, and then select [View certificates].

12

Click [Install Certificate] in the displayed dialog box to run the Certificate Import Wizard.

13

Click [Next], select [Place all certificates in the following store], and then click [Browse].

14

Select [Trusted Root Certification Authorities], and then complete the Wizard following the instructions on the screen.

15

If you cleared the [Enable Protected Mode (requires restarting Internet Explorer)] check box in Step 7, select the check box.

Connecting the Printer (WSD)

04L9-094

NOTE

If the confirmation dialog box appears during the procedure

Enter the user name and password. For more details, see the manual etc. supplied with the operating system.

1

Confirm the setting for [Receive/Print Range Setting].

Make sure that the IP address of the computer on which the printer driver is installed is not restricted to print.

➤ ["Restricting the Users Who Can Print or Perform the Printer Settings"](#)

IMPORTANT

If printing is restricted

You cannot install the printer driver.

If printing is restricted after the installation

If the IP address of the computer on which the printer driver is installed is restricted to perform printing in [Receive/Print Range Setting], you cannot print from the computer.

2

Install the printer driver.

Following the procedure for when you are using a WSD network environment in "Printer Driver Installation Guide", install the printer driver.

† For details on the procedure for viewing "Printer Driver Installation Guide", see "[Installation.](#)"

Network Settings for the Printer (NetWare) (LBP6680x Only)

04L9-095

The requisite tasks to use the printer in the NetWare network are as follows.

Before starting NetWare network settings, see "Attention (NetWare Network Settings)."



IMPORTANT

Configuring a Computer that Performs Printing

After completing the NetWare network settings, configure each computer to be used for printing.

(1) Connecting to an NetWare Network

Install NetWare client software on all the computers that perform printing, and then log in to the NetWare server or to the tree.

For details on the NetWare Network connection, see the instruction manual for NetWare or the operating systems.

(2) Connecting the Printer

Install the printer driver using the procedure for installing the printer driver for a local area connection or network environment in "Printer Driver Installation Guide."

When you install the printer driver, select [Network printer] for the printer connection, and then select the print queue created in "[Configuring NetWare](#)."

If a screen for selecting a port appears during the installation, select [Network], and then click [Settings].

From the list, select the print queue created in "[Configuring NetWare](#)."

To perform printing using a NetWare network, you need to configure the print service such as the print server and queue and the printer protocols.

IMPORTANT

About the print service settings

When specifying the print service settings using NetSpot Device Installer or NetWare Administrator, Novell Client (a NetWare client from Novell, Inc.) needs to be installed as a client software on the computer on which NetWare Administrator will run.

Types of the Print Service

Before configuring the print service, select the type of the print service referring to the following descriptions.

NOTE

About describing the print service in this manual

Usually, select the print service of NDS for NetWare 4.x or later and the print service in Bindery Mode for NetWare 3.x. This manual does not describe the other settings.

About NDPS

You can also use NDPS as the print service on NetWare 5.x or later. When using NDPS, use Novell Printer Gateway supplied with NetWare as the gateway. This manual does not describe the procedure for setting NDPS. For the setting procedure, see the instruction manual of NetWare.

• **NDS (Novell Directory Services) and Bindery Mode**

This printer supports both NDS and Bindery Mode. Select the appropriate mode for your network environment. If you are using NetWare 3.x, you can use only Bindery Mode.

• **Queue Server Mode and Remote Printer Mode**

This printer supports both the Queue server mode and Remote Printer mode.

– **Queue Server Mode**

When using Queue Server Mode, you do not need any other hardware or software for the print server because this printer is provided with all the functions of the print server.

NDS Queue Server Mode (NDS PServer) uses a NDS print server for printing. Bindery Queue Server Mode (Bindery PServer) uses a Bindery print server for printing. Queue Server Mode requires one NetWare user license per printer.

– **Remote Printer Mode**

In Remote Printer Mode, this printer is controlled by a NetWare print server. Therefore, you need a NetWare print server other than this printer. NDS Remote Printer Mode (NPrinter) uses a NDS print server for printing. Bindery Remote Printer Mode (RPrinter) uses a Bindery print server for printing.

Configuring NetWare

If there is any operating system that supports NetSpot Device Installer on the network, configure the NetWare print server using NetSpot Device Installer.

If there is no operating system that supports NetSpot Device Installer on the network, configure the NetWare print server using NetWare Administrator or PCONSOLE.

Settings Using NetSpot Device Installer

For details on the procedures for installing or using NetSpot Device Installer, see the Readme file in the following folder in Printer Driver Software CD-ROM.

Settings Using NetWare Administrator (When Using the Printer in NDS Queue Server Mode/NDS Remote Printer Mode)

1

Log in to NetWare as "Admin" (or a user who has the equivalent permissions), and then run NetWare Administrator.

1. Select [Print Services Quick Setup] from the [Tools] menu.
2. In [Print Server name], enter an arbitrary name. To use an existing print server, click the button on the right of [Print Server name], and then select the print server from the list.
3. In [Name] for the printer, enter an arbitrary name.
4. When using the printer in Queue Server Mode, select [Other/Unknown] in [Type].
5. When using the printer in Remote Printer Mode, select [Parallel] in [Type], and then click [Communication]. Set [Port] to [LPT1] and [Connection type] to [Manual load].
6. In [Name] for the print queue, enter an arbitrary name.
7. In [Volume], enter the volume object (the object that indicates the physical volume on the network) that creates the queue. You can select the volume object from a list by clicking the button on the right.
8. Specify the other settings, and then click [OK].

NOTE

About entering the print server name

Because the print server name is required for the protocol settings for the printer, note it down.

About Quick Setup

If you perform Quick Setup, the printer is allocated to the printer number "0."

When using the printer in Queue Server Mode, do not change the printer number from "0."

2

When using the printer in Remote Printer Mode, start the print server.

When using the NetWare file server as the print server, enter "LOAD PSERVER.NLM" in the file server, and then press the [ENTER] key on your keyboard.

→ The settings for NetWare print service are now completed.

NOTE

About Queue Server Mode

When using the printer in Queue Server Mode, you do not need to specify these settings.

3

Next, configure the NetWare protocol settings for the printer.

For details on the procedure for configuring the NetWare protocol, see "[Configuring the Protocol Settings.](#)"

Settings Using PCONSOLE (When Using the Printer in Bindery Queue Server Mode/Bindery Remote Printer Mode)

1

Log in to NetWare as the Supervisor, and then start PCONSOLE.

2

If you have not created a print server, create the print server.

1. Select [Print Server Information] from [Available Options], and then press the [ENTER] key on your keyboard.
2. Press the [INSERT] key on your keyboard.
3. Enter the name of the print server to be created, and then press the [ENTER] key on your keyboard.
4. Press the [ESC] key on your keyboard to go back to the [Available Options] list.

NOTE

About entering the print server name

Because the print server name is required for the protocol settings for the printer, note it down.

About using multiple NetWare servers

If you are using multiple NetWare servers and want to use this printer in Queue Server Mode, use the same print server name for all the NetWare servers.

3

Create a queue, and then assign the print server to the queue.

1. From [Available Options] select [Print Queue Information], and then press the [ENTER] key on your keyboard.
2. Press the [INSERT] key on your keyboard.
3. Enter the name of the queue to be created, and then press the [ENTER] key on your keyboard.
4. Select the name of the created queue, and then press the [ENTER] key on your keyboard.
5. Select [Queue Servers], and then press the [ENTER] key on your keyboard.
6. Press the [INSERT] key on your keyboard.
7. Select the print server created in Step 2, and then press the [ENTER] key on your keyboard.
8. Press the [ESC] key on your keyboard repeatedly to go back up to [Available Options].

4

Assign the printer to the print server.

1. Select [Print Server Information] from [Available Options], and then press the [ENTER] key on your keyboard.
2. Select the print server created in Step 2, and then press the [ENTER] key on your keyboard.
3. Select [Print Server Configuration], and then press the [ENTER] key on your keyboard.
4. Select [Printer Configuration], and then press the [ENTER] key on your keyboard.
5. From the [Configured Printers] list, select the printer number, and then press the [ENTER] key on your keyboard.
When using the printer in Queue Server Mode, select the printer number "0."
When using the printer in Remote Printer Mode, you can select an arbitrary printer number.

5

Specify the name or type of the printer.

1. Enter an arbitrary printer name in [Name], and then press the [ENTER] key on your keyboard.
2. When using the printer in Queue Server Mode, select [Defined] in [Type].
3. When using the printer in Remote Printer Mode, select [Remote Parallel] in [Type], and then set [Port] to [LPT1].
4. Specify the settings for the other options, and then press the [ESC] key on your keyboard.
5. If the confirmation box appears, select [Yes], and then press the [ENTER] key on your keyboard.
6. Press the [ESC] key on your keyboard to go back to the [Print Server Configuration] list.

6

Assign a queue to the printer.

1. Select [Queues Serviced by Printer], and then press the [ENTER] key on your keyboard.
2. Select the printer name specified in Step 5, and then press the [ENTER] key on your keyboard.
3. Press the [INSERT] key on your keyboard.
4. Select the queue created in Step 3, and then press the [ENTER] key on your keyboard.

7

Press the [ESC] key on your keyboard until the [Exit PCONSOLE] window appears, and then select [Yes] to exit PCONSOLE.

8

When using the printer in Remote Printer Mode, start the print server.

1. When you are using a computer exclusively as the print server, enter "PSERVER.EXE" in the computer as the print server name, and then press the [ENTER] key on your keyboard.
 2. When using the NetWare file server as the print server, enter "LOAD PSERVER.NLM <the print server name>" in the file server, and then press the [ENTER] key on your keyboard.
- The settings for NetWare print service are now completed.

NOTE

About Queue Server Mode

When using the printer in Queue Server Mode, you do not need to specify these settings.

9

Next, configure the NetWare protocol settings for the printer.

For details on the procedure for configuring the NetWare protocol, see "[Configuring the Protocol Settings.](#)"

Configuring the Protocol Settings

04L9-098

This section describes the procedure for specifying the settings using the Remote UI.

† In the Remote UI, you can specify the settings by accessing the printer from a Web browser via a network.

IMPORTANT

Before configuring the protocol settings

- When configuring the protocol settings for the printer using the above software, the TCP/IP protocol must be able to be used in your network environment.
- Make sure that each setting option for TCP/IP is specified, the printer and computer are connected properly, and the printer is ON.

NOTE

When specifying the settings using software other than the Remote UI

You can also specify the settings using the following software.

➤ "FTP Client"

You can specify the settings by accessing the FTP server of the printer using Command Prompt.

- † The specifiable options vary depending on the software. See "[Network Setting Items](#)" and use software appropriate to the network environment you are using or options that you want to specify.

1

Start the Remote UI, and then log in as Administrator.

➤ "Starting the Remote UI"

2

Click [Settings/Registration].

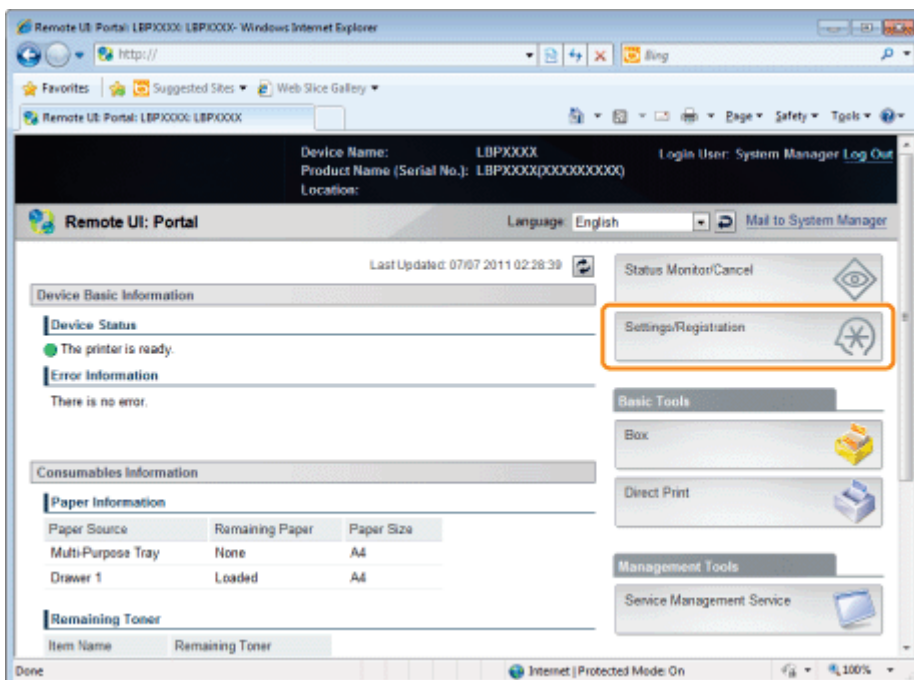

3

Select **[Network]** from the **[Preferences]** menu.

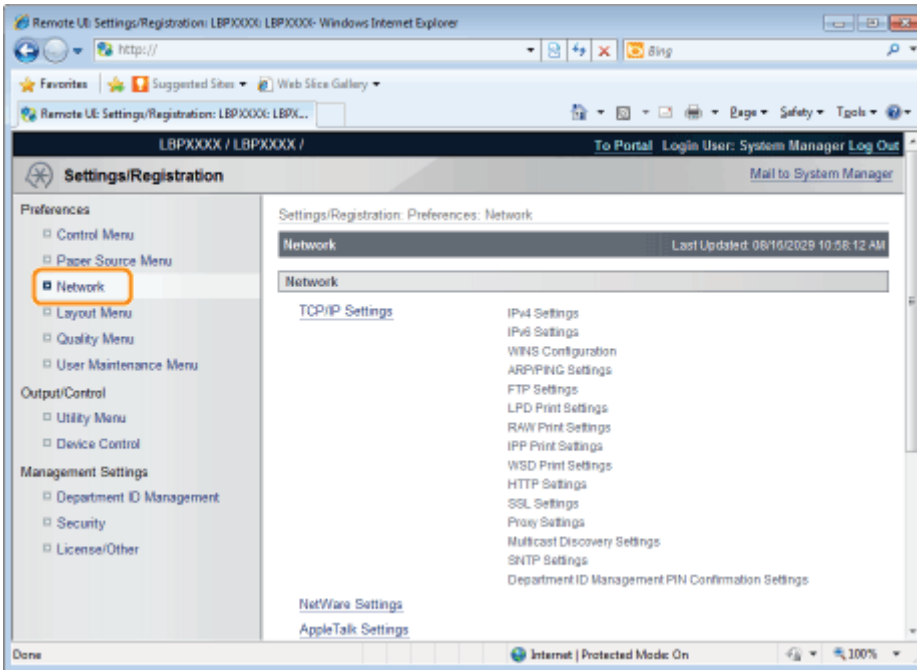

4

Click **[NetWare Settings]**.

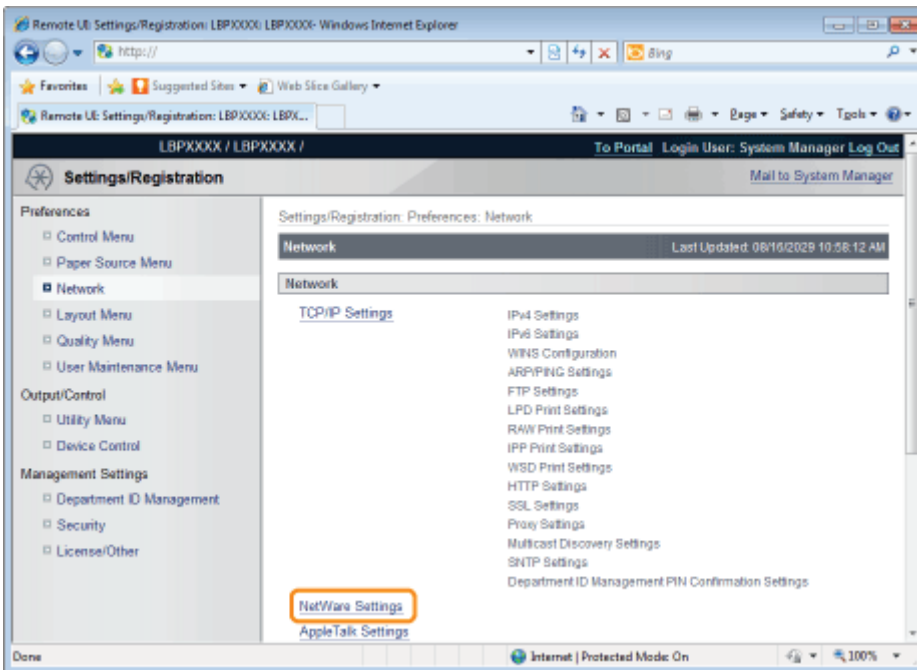

5

Click **[Edit...]**.

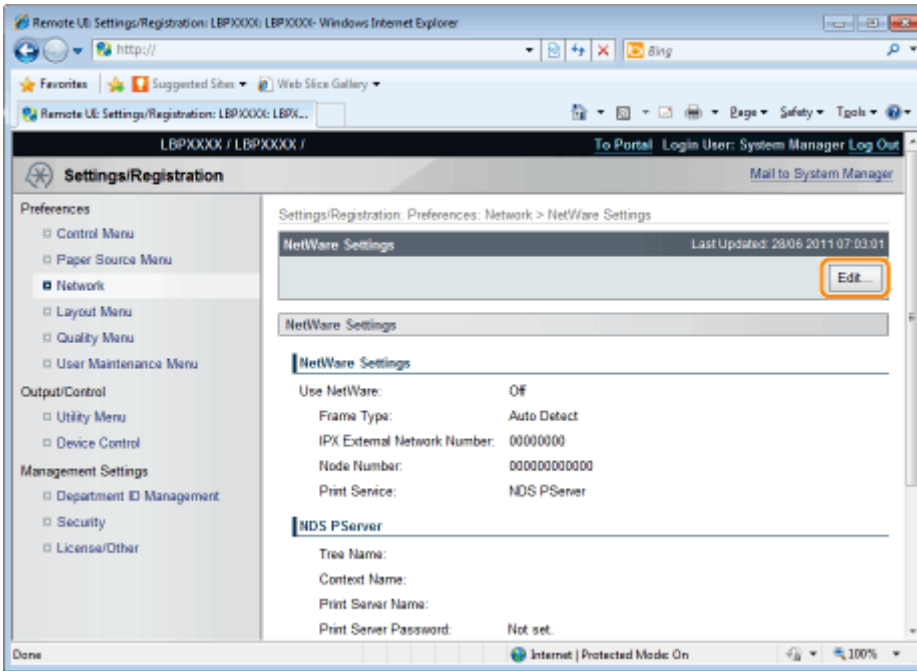

6

Select the [Use NetWare] check box.

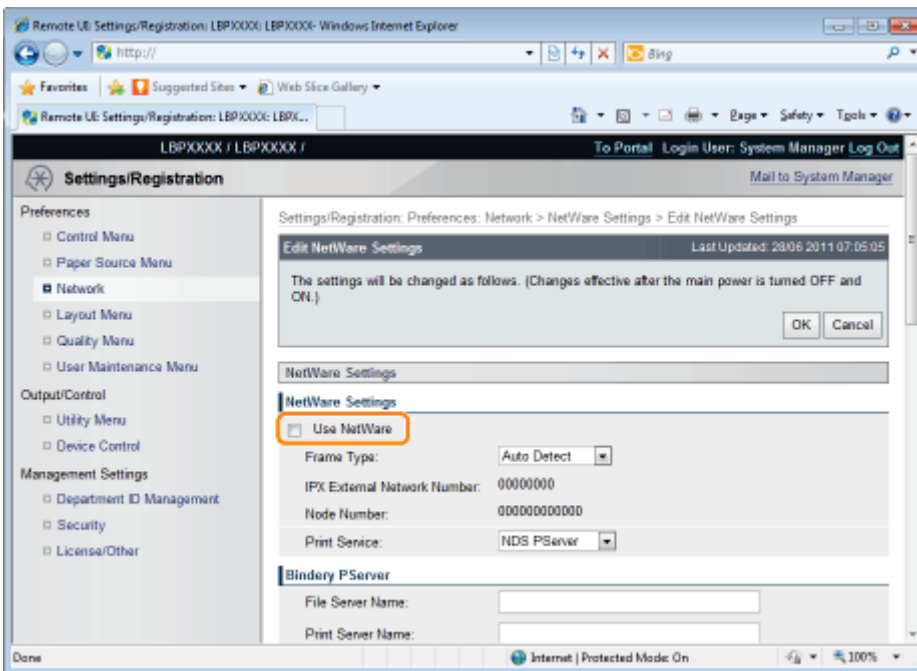

NOTE

When the [Use NetWare] check box is cleared

The printer is not detected on the NetWare network.

7

Set [Frame Type].

Select the frame type that is used by the system environment you are using from [Auto Detect], [Ethernet II], [Ethernet 802.2], [Ethernet 802.3] or [Ethernet SNAP].

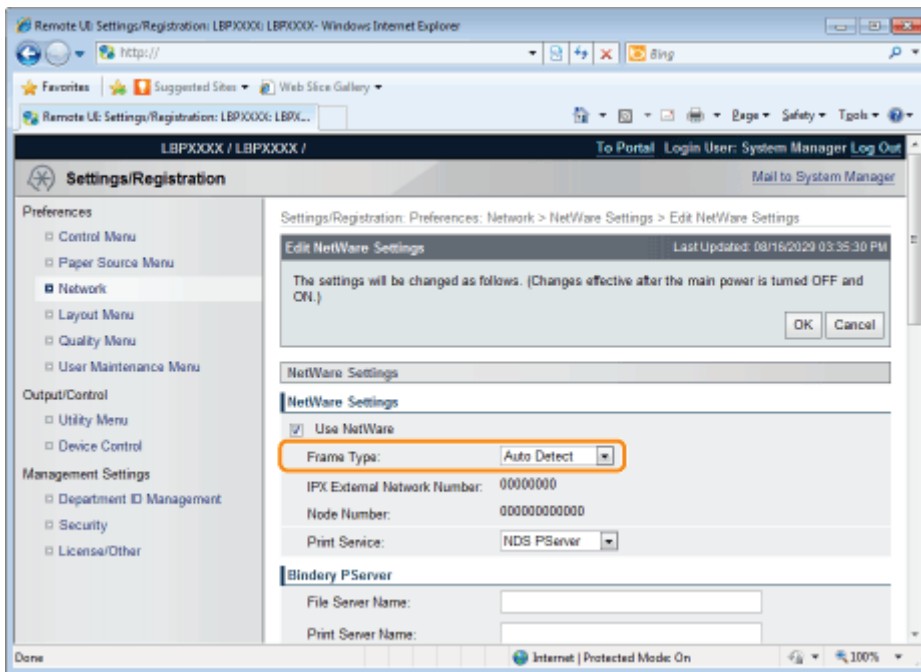

When using Bindery PServer: Queue Server Mode (the print server of Bindery Mode)

1. Select [Bindery PServer] from [Print Service].
2. In [File Server Name], enter the file server name created in "Configuring NetWare."
3. In [Print Server Name], enter the print server name created in "Configuring NetWare."
4. In [Print Server Password], enter the password for the print server.
5. In [Printer Number], enter the same printer number as the one specified in "Configuring NetWare."
6. Specify the settings for [Service Mode], [Printer Form], [Polling Interval], and [Buffer Size] as needed.

When using NDS PServer: Queue Server Mode (the print server of NDS)

1. Select [NDS PServer] from [Print Service].
2. In [Tree Name] and [Context Name], enter the name of the tree to which the print server belongs and the context name.
3. In [Print Server Name], enter the print server name created in "Configuring NetWare."
4. In [Print Server Password], enter the password for the print server.
5. In [Printer Number], enter the same printer number as the one specified in "Configuring NetWare."
6. Specify the settings for [Service Mode], [Printer Form], [Polling Interval], and [Buffer Size] as needed.

When using RPrinter: Remote Printer Mode (the print server of Bindery Mode)

1. Select [RPrinter] from [Print Service].
2. In [File Server Name], enter the file server name created in "Configuring NetWare."
3. In [Print Server Name], enter the print server name created in "Configuring NetWare."
4. In [Printer Number], enter the same printer number as the one specified in "Configuring NetWare."

When using NPrinter: Remote Printer Mode (the print server of NDS)

1. Select [NPrinter] from [Print Service].
2. In [Tree Name] and [Context Name], enter the name of the tree to which the print server belongs and the context name.
3. In [Print Server Name], enter the print server name created in "Configuring NetWare."
4. In [Printer Number], enter the same printer number as the one specified in "Configuring NetWare."

8

Click [OK].

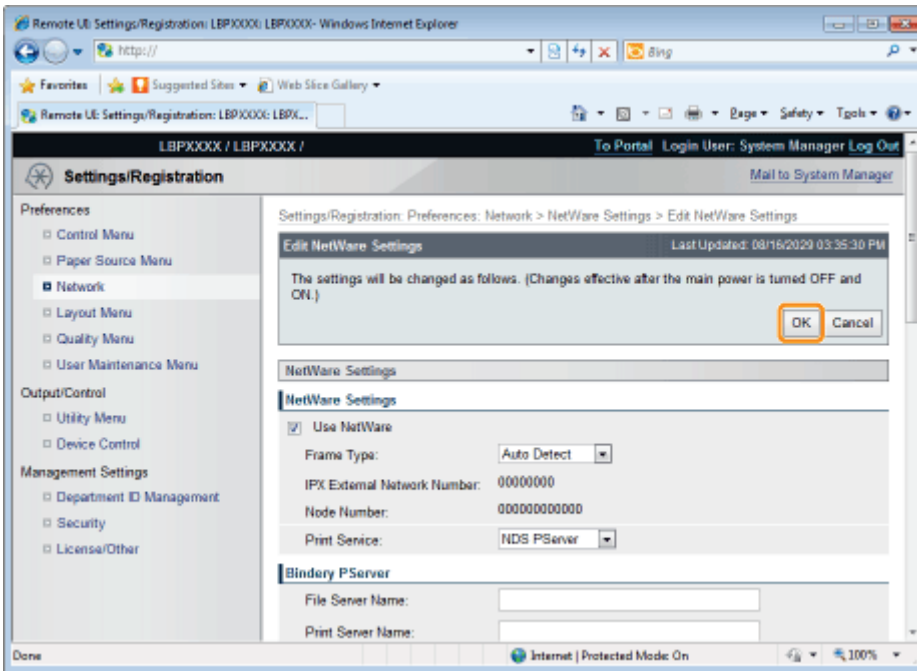

9

Perform a hard reset or restart the printer.

→ After performing a hard reset or restarting the printer, the settings are effective.

NOTE

To perform a hard reset

You can perform a hard reset using the following procedure.

1. Click [Settings/Registration].
2. Select [Device Control] from the [Output/Control] menu.
3. Select [Hard Reset], and then click [Execute].

Network Settings for the Printer (SMB) (LBP6680x Only)

04L9-099

The requisite tasks to use the printer in the SMB network are as follows.

Before starting SMB network settings, see "Attention (SMB Network Settings)."



Attention (SMB Network Settings)

04L9-09A

IMPORTANT

Configuring a Computer that Performs Printing

After completing the protocol settings for the printer, configure each computer to be used for printing.

About the protocol used in an SMB network

An SMB network supports only NetBIOS over TCP/IP, but not NetBEUI.

You need to install TCP/IP client software on all the computers to be used for printing to make them able to use a TCP/IP network. For more details, see the instruction manual for the operating system.

Configuring the Protocol Settings

04L9-09C

This section describes the procedure for specifying the settings using the Remote UI.

† In the Remote UI, you can specify the settings by accessing the printer from a Web browser via a network.

IMPORTANT

Before configuring the protocol settings

- When configuring the protocol settings for the printer using the above software, the TCP/IP protocol must be able to be used in your network environment.
- Make sure that each setting option for TCP/IP is specified, the printer and computer are connected properly, and the printer is ON.

About SMB printing

You can use SMB printing only when an SD card is installed.

NOTE

When specifying the settings using software other than the Remote UI

You can also specify the settings using the following software.

➤ ["FTP Client"](#)

You can specify the settings by accessing the FTP server of the printer using Command Prompt.

- † The specifiable options vary depending on the software. See "[Network Setting Items](#)" and use software appropriate to the network environment you are using or options that you want to specify.

About the screenshots

This procedure is described using screenshots from Windows 7.

1

Start the Remote UI, and then log in as Administrator.

➤ ["Starting the Remote UI"](#)

2

Click [Settings/Registration].

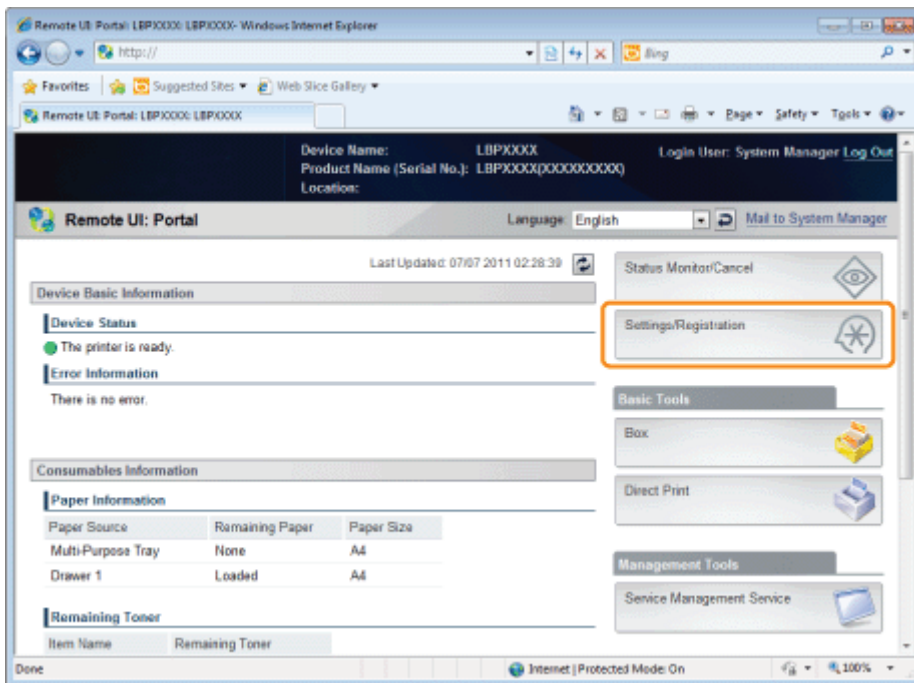

3

Select **[Network]** from the **[Preferences]** menu.

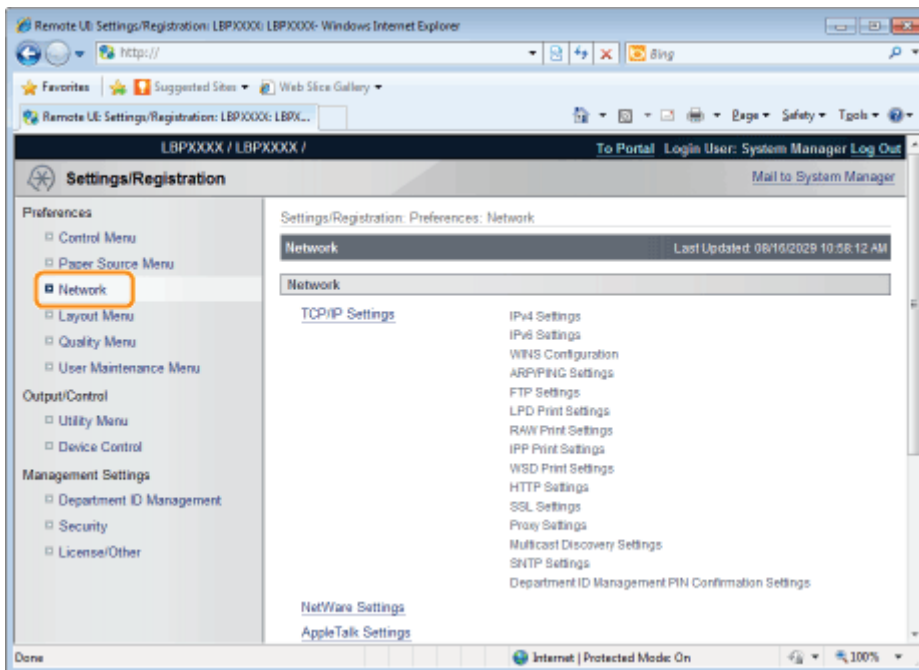

4

Click **[SMB Settings]**.

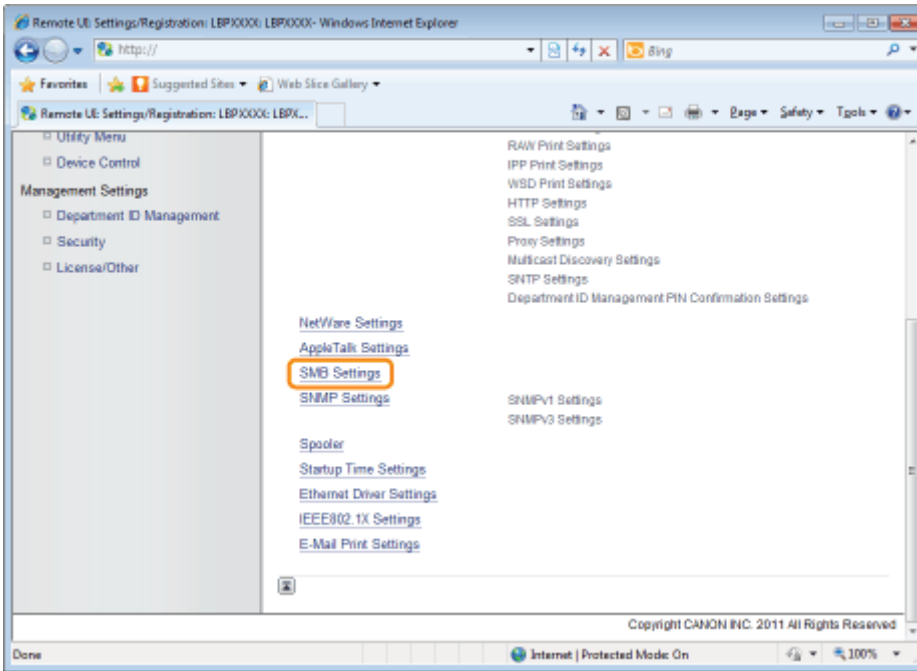

5

Click [Edit...].

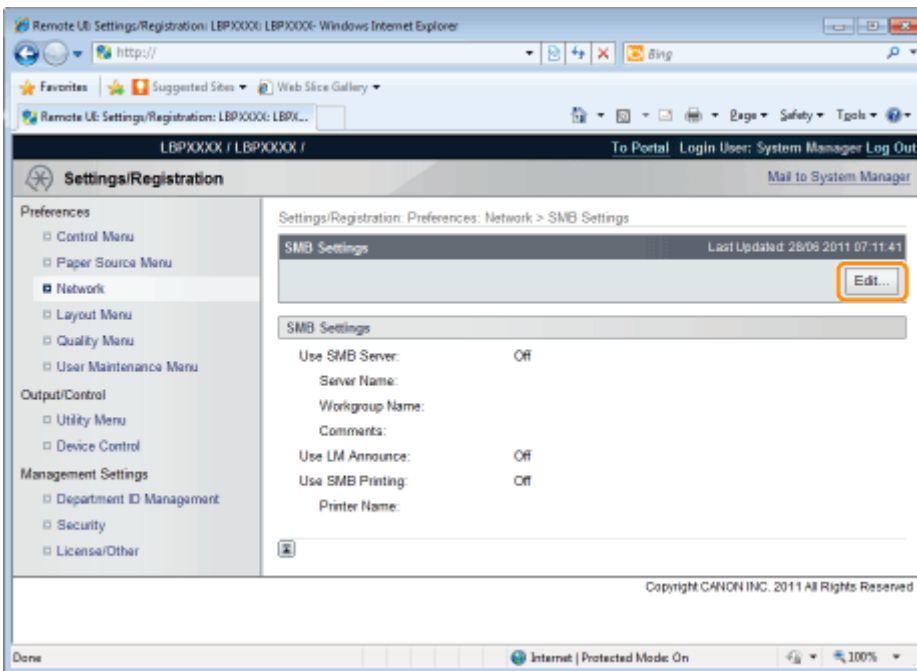

6

Select the [Use SMB Server] check box.

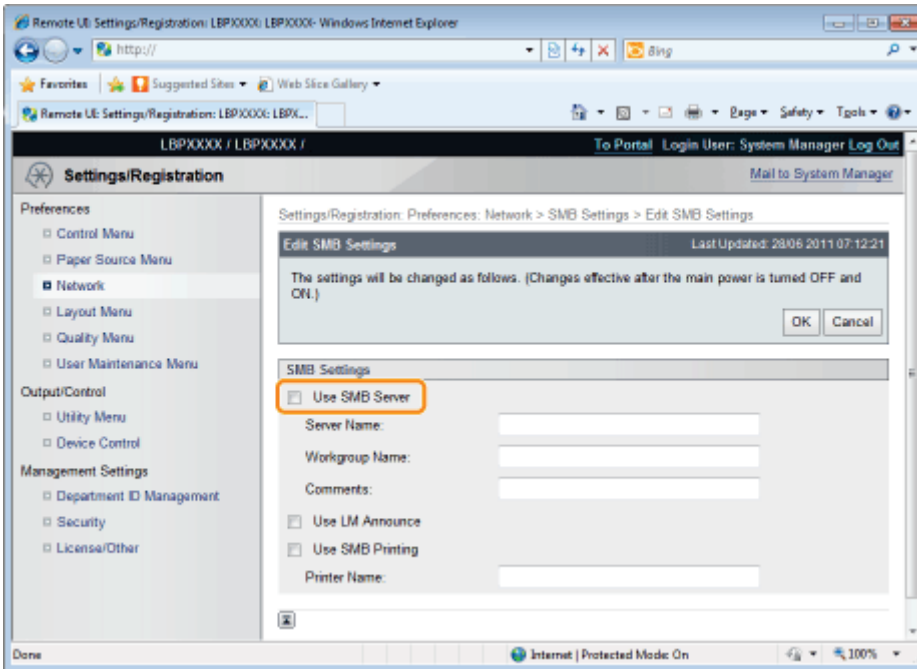

NOTE

When the [Use SMB Server] check box is cleared

The printer is not detected on the SMB network.

7

Specify the settings for SMB.

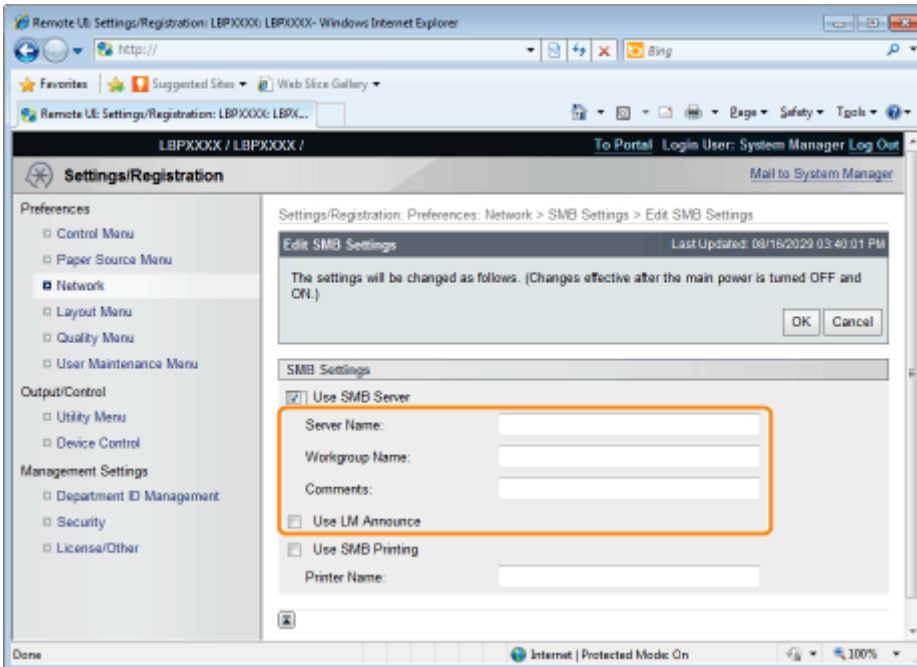

<p>[Server Name]</p>	<p>Enter the computer name to which the printer belongs. Up to 15 characters can be entered.</p> <ul style="list-style-type: none"> † Enter a name that does not overlap with the names used on the other computers or the printers on the network. † You cannot enter a space between characters.
	<p>Enter the name of the work group to which the printer belongs. Up to 15 characters can be entered.</p>

[Workgroup Name]	<ul style="list-style-type: none"> † If there is no workgroup in your system environment, create a workgroup on Windows, and then enter the workgroup name. † You cannot enter a space between characters.
[Comments]	If necessary, enter comments about the printer. You can enter up to 48 characters.
[Use LM Announce]	<p>When announcing the existence of the printer to the LAN Manager, select the [Use LM Announce] check box. When not making an announcement, clear [Use LM Announce].</p> <ul style="list-style-type: none"> † When it is not necessary for the LAN Manager to reference the printer, you can clear the [Use LM Announce] check box and reduce network traffic.

8

Specify the settings for SMB printing.

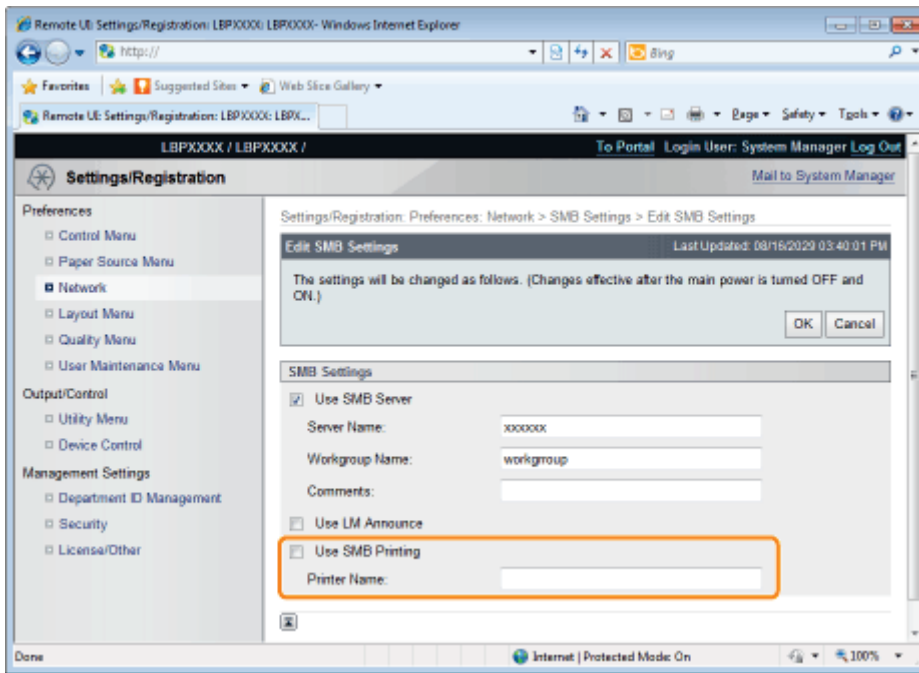

When using SMB printing

1. Select the [Use SMB Printing] check box.
2. Enter the name of this printer in [Printer Name]. Up to 13 alphanumeric characters can be entered.
 - † You cannot enter a space between characters.

When not using SMB printing

Clear the [Use SMB Printing] check box.

9

Click [OK].

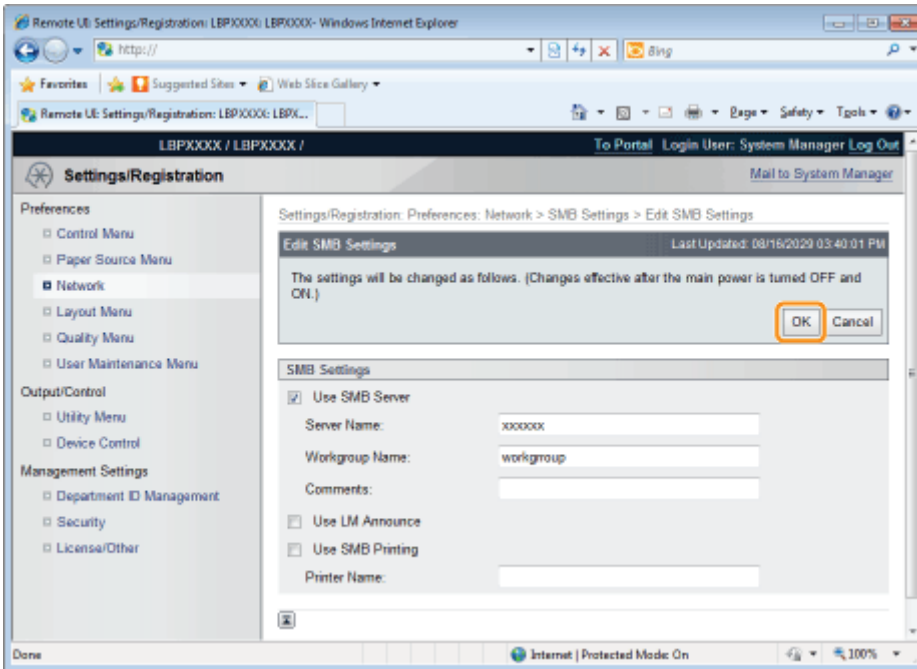

If you want to specify the settings for WINS, proceed to Step 10.

If you do not want to specify the settings for WINS, proceed to Step 14.

10

When setting WINS, select [Network] in [Preferences].

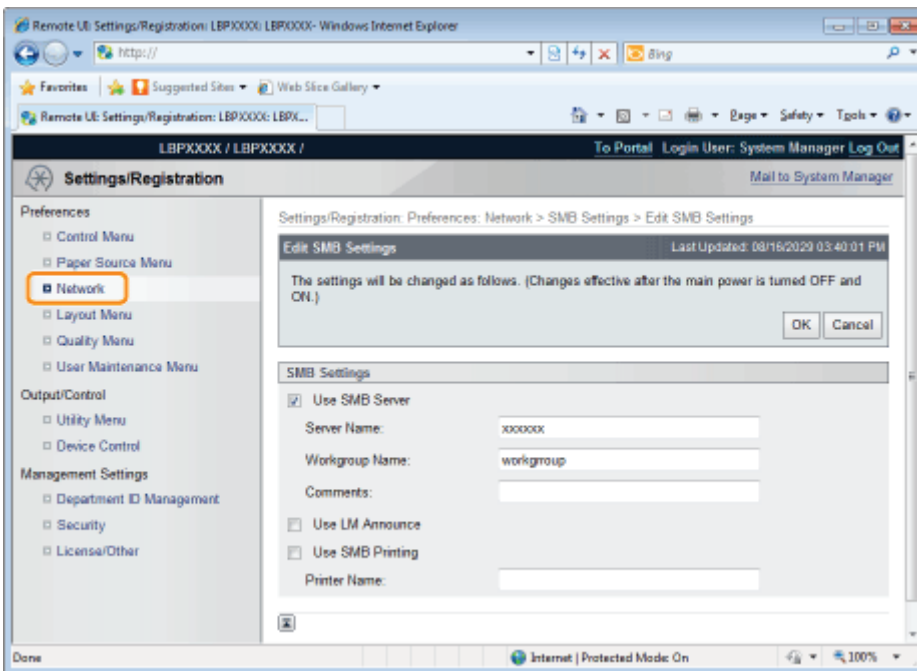

11

Click [TCP/IP Settings].

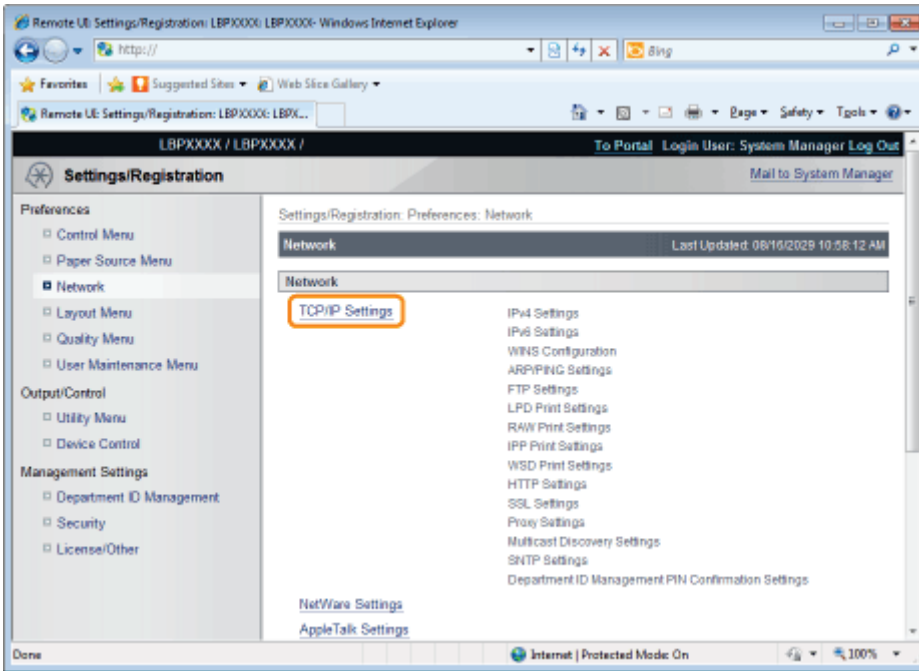

12

Click [Edit...] in [WINS Configuration].

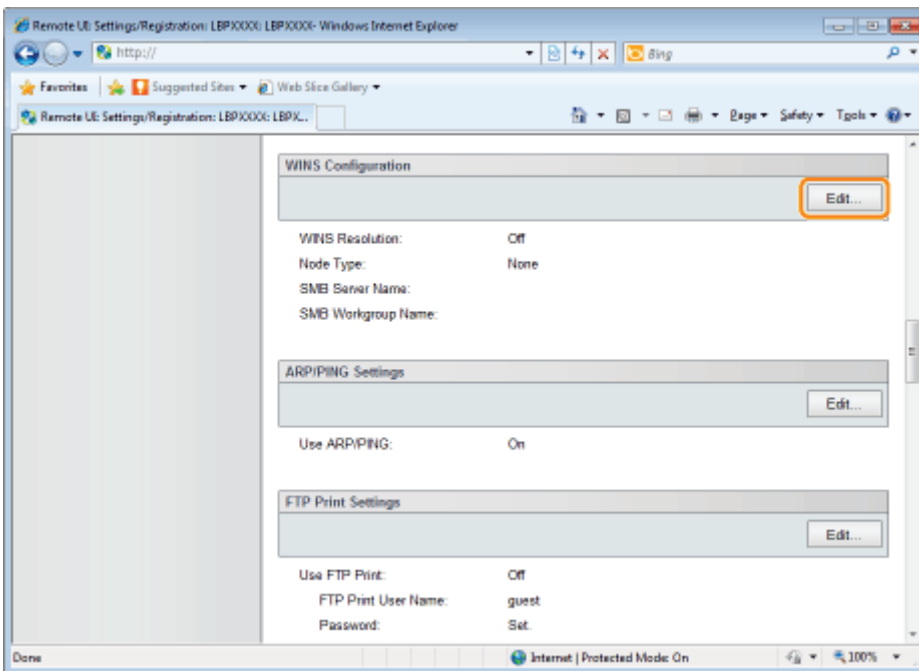

13

Set WINS.

When Using WINS Resolution

Select the [WINS Resolution] check box, and set the following items.

[WINS Server Address]	<p>Enter the IP address of the WINS server.</p> <p>↑ When using the IP address settings specified by DHCP, if you obtain the WINS server IP address from the DHCP server, the IP address obtained from the DHCP server is overwritten.</p>
-----------------------	--

[Scope ID]	<p>Enter [Scope ID] as needed. You can enter up to 63 characters.</p> <ul style="list-style-type: none"> † The scope ID is an identifier to determine the range available for printers and computers. The scope ID is browsed regardless of the WINS resolution settings. † When a scope ID is not specified for the computer in your network environment, leave the [Scope ID] field blank.
Set the following items when registering printers on the WINS server.	
[SMB Server Name]	Enter the WINS server name set in Procedure 7.
[SMB Workgroup Name]	Enter the workgroup name set in Procedure 7.

When not Using WINS Resolution

Clear the [WINS Resolution] check box.

IMPORTANT

If [Scope ID] is specified

The printer cannot communicate with the computers that have a different scope ID.

14

Click [OK].

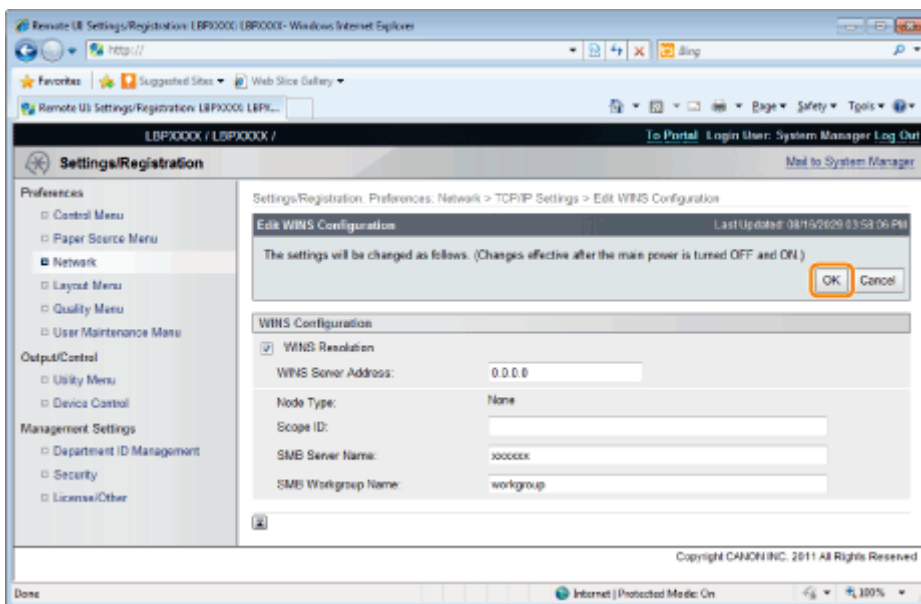

15

Perform a hard reset or restart the printer.

→ After performing a hard reset or restarting the printer, the settings are effective.

NOTE

To perform a hard reset

You can perform a hard reset using the following procedure.

1. Click [Settings/Registration].
2. Select [Device Control] from the [Output/Control] menu.
3. Select [Hard Reset], and then click [Execute].

Configuring a Computer that Performs Printing

04L9-09E

Configure all the computers to be used for printing so that they can be used on an SMB network.

Connecting to an SMB Network

1

Perform the following procedure.

Windows 2000

From the [Start] menu, select [Settings] → [Network and Dial-Up Connections].

Windows XP

From the [Start] menu, select [Control Panel], and then click [Network and Internet Connections] → [Network Connections].

Windows Vista

From the [Start] menu, select [Control Panel], and then click [View network status and tasks] → [Manage network connections].

Windows 7 Windows Server 2008 R2

From the [Start] menu, select [Control Panel], and then click [View network status and tasks] → [Change adapter settings].

Windows Server 2003

From the [Start] menu, select [Control Panel] → [Network Connections] → [Local Area Connection].

Windows Server 2008

From the [Start] menu, select [Control Panel], double-click [Network and Sharing Center], and then click [Manage network connections].

2

Display the [Local Area Connection Properties] dialog box.

Windows 2000 Windows XP Windows Vista Windows 7 Windows Server 2008

Right-click the [Local Area Connection] icon, and then select [Properties] from the pop-up menu.

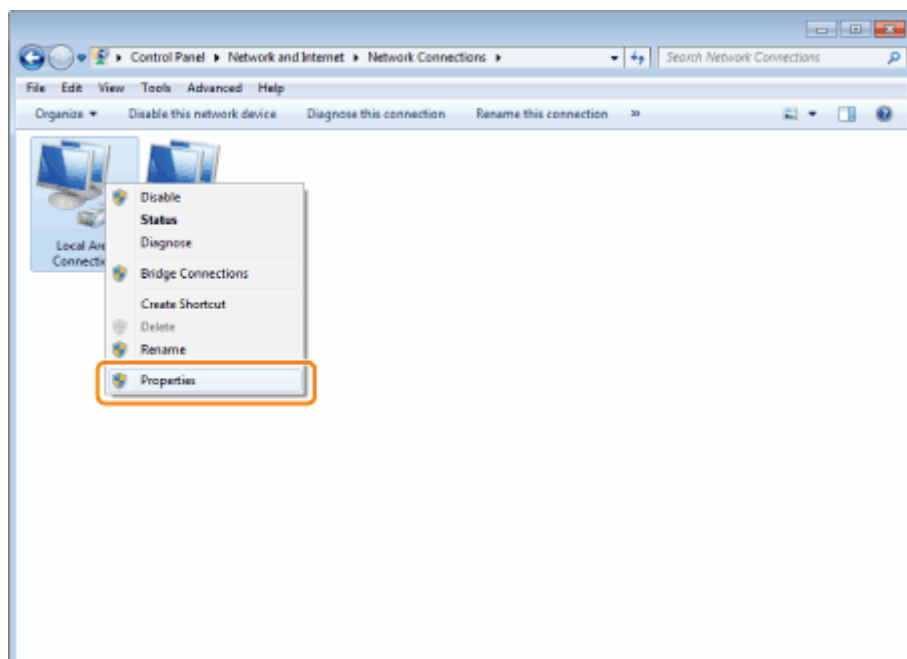

Windows Server 2003

Click [Properties].

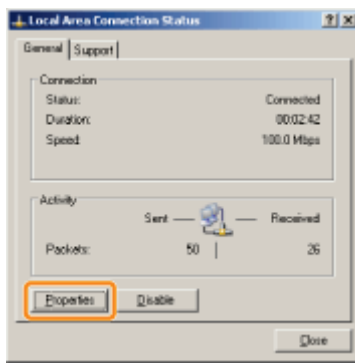

? If the [User Account Control] dialog box appears

Click [Yes] or [Continue].

3

Make sure that the check boxes for the following options are selected.

- [Client for Microsoft Networks]
- [Internet Protocol Version 4 (TCP/IPv4)] (or [Internet Protocol (TCP/IP)])

If the check boxes are not selected, select them.

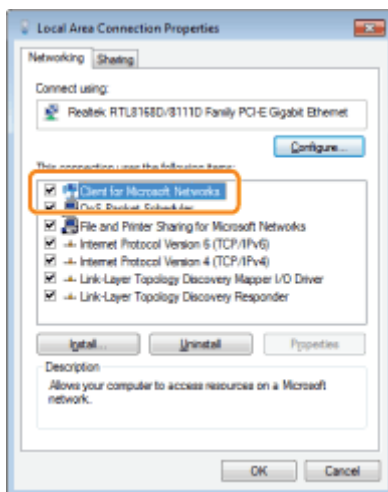

4

Double-click [Internet Protocol Version 4 (TCP/IPv4)] (or [Internet Protocol (TCP/IP)]).

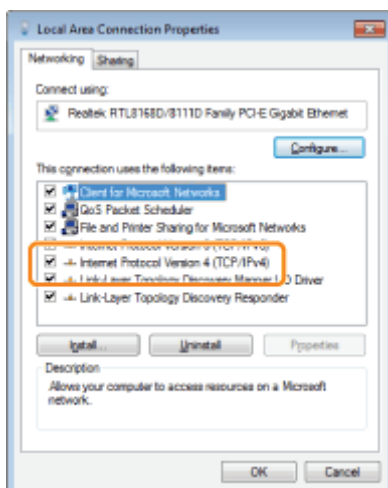

5

Click **[Advanced]** in the **[General]** sheet.

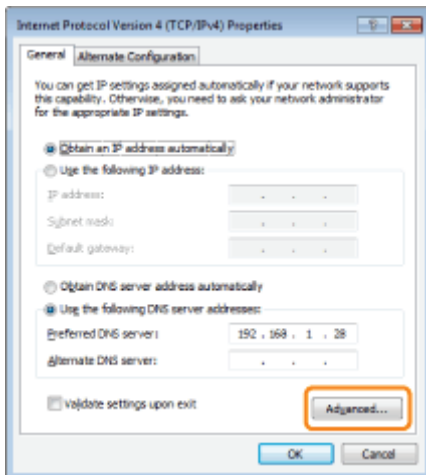

6

Enable NetBIOS over TCP/IP.

- (1) Display the **[WINS]** sheet.
- (2) Select **[Enable NetBIOS over TCP/IP]**.
- (3) Click **[OK]**.

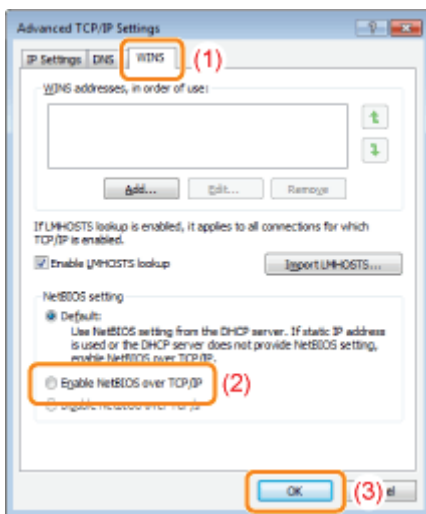

7

Continue to click **[OK]** until all the dialog boxes close.

? If a message that prompts you to restart the computer appears
Restart the computer.

Installing the Printer Driver

A printer driver is required for printing. Following "Printer Driver Installation Guide", install the printer driver.

† For details on the procedure for viewing "Printer Driver Installation Guide", see "[Installation](#)."

 **NOTE**

If the screen that prompts you to select a port appears during the installation

Perform the following procedure.

1. Click [Add Port].
2. Select [Network], and then click [OK].
3. From the list, select [Workgroup Name], [Server Name], and [Printer Name] specified in "[Configuring the Protocol Settings](#)" respectively.

Network Settings for the Printer (AppleTalk)

04L9-09F

The requisite tasks to use the printer in the AppleTalk network are as follows.

† If you are using Mac OS X 10.6, see "[Network Settings for the Printer \(TCP/IP\)](#)", and specify the settings for the network.

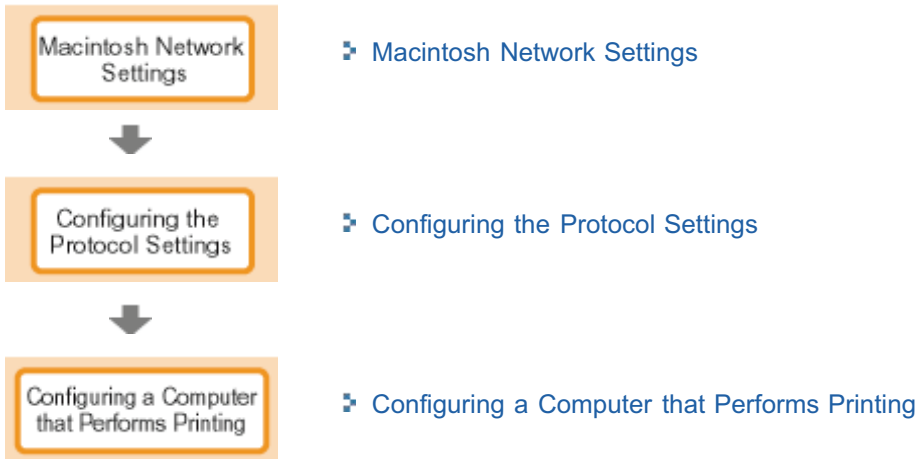

Macintosh Network Settings

04L9-09H

Configure the Macintosh network settings.

1

Select [System Preferences] from the Apple menu.

2

Click [Network].

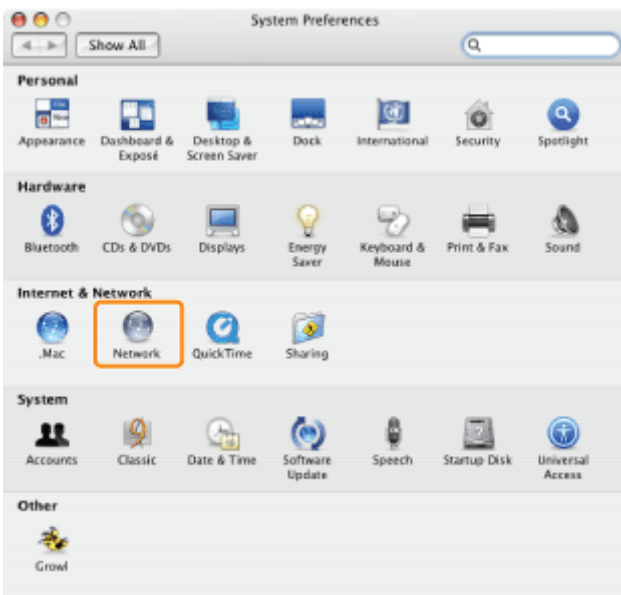

3

Check the settings for the network port.

- (1) Select [Network Port Configurations] from [Show].
- (2) Make sure that the [Built-in Ethernet] check box is selected.
(If the check box is not selected, select it.)

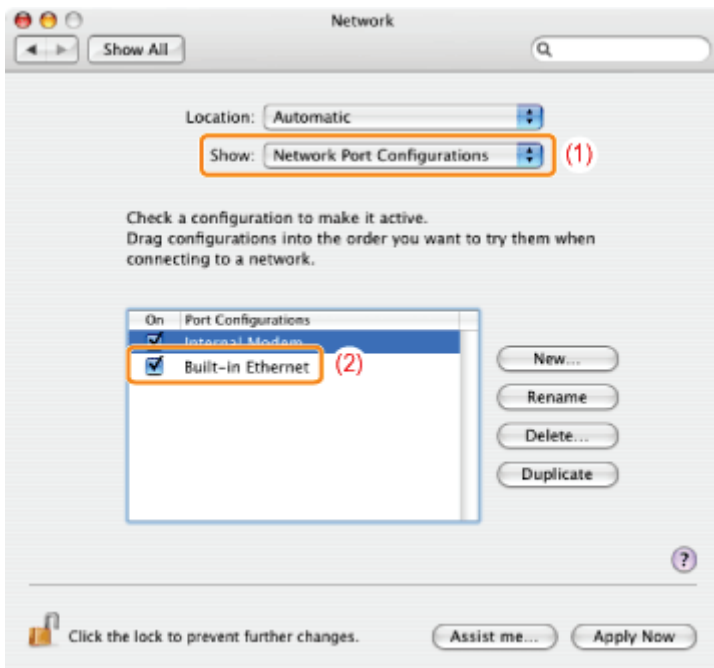

4

Make sure AppleTalk is active.

- (1) Select [Built-in Ethernet] from [Show].
- (2) Click [AppleTalk].
- (3) Make sure that the [Make AppleTalk Active] check box is selected.
(If the check box is not selected, select it.)

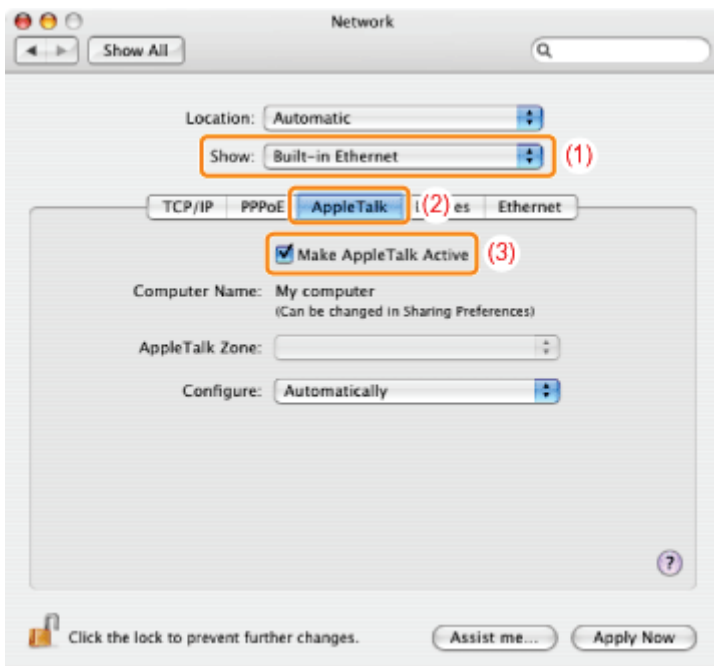

NOTE

If [Built-in Ethernet] does not appear in [Show]

Select [Network Port Configurations], and then select the [Built-in Ethernet] check box.

5

Close the [Network] dialog box, and then save the settings.

Configuring the Protocol Settings

04L9-09J

This section describes the procedure for specifying the settings using the Remote UI.

† In the Remote UI, you can specify the settings by accessing the printer from a Web browser via a network.

IMPORTANT

Before configuring the protocol settings

- When configuring the protocol settings for the printer using the above software, the TCP/IP protocol must be able to be used in your network environment.
- Make sure that each setting option for TCP/IP is specified, the printer and computer are connected properly, and the printer is ON.

NOTE

When specifying the settings using software other than the Remote UI

You can also specify the settings using the following software.

"FTP Client (Macintosh)"

You can specify the settings by accessing the FTP server of the printer using Command Prompt.

- † The specifiable options vary depending on the software. See "[Network Setting Items](#)" and use software appropriate to the network environment you are using or options that you want to specify.

About the screenshots

This procedure is described using screenshots from Windows 7.

1

Start the Remote UI, and then log in as Administrator.

 "[Starting the Remote UI](#)"

2

Click [Settings/Registration].

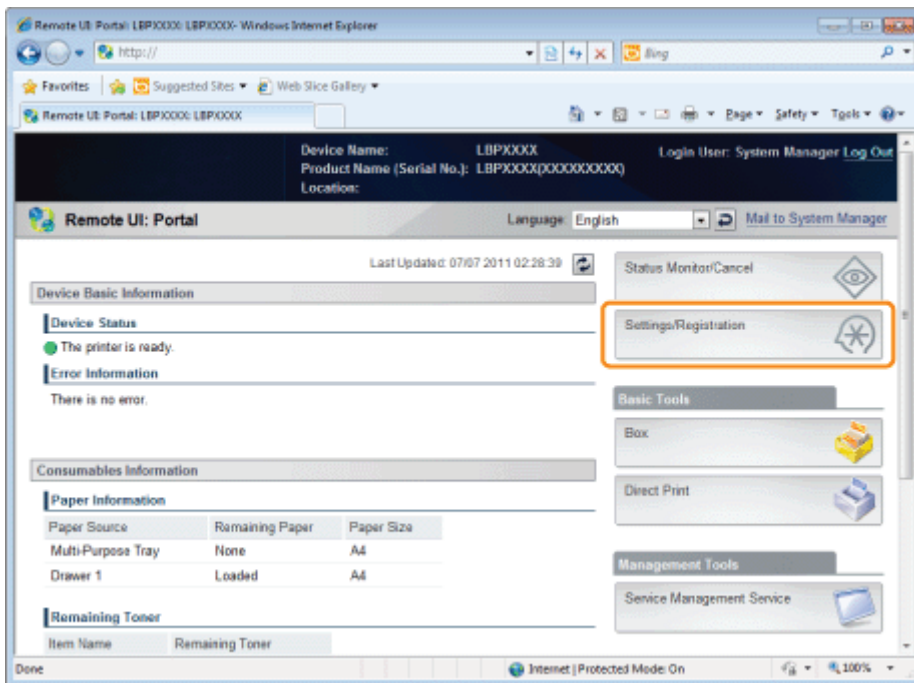

3

Select [Network] from the [Preferences] menu.

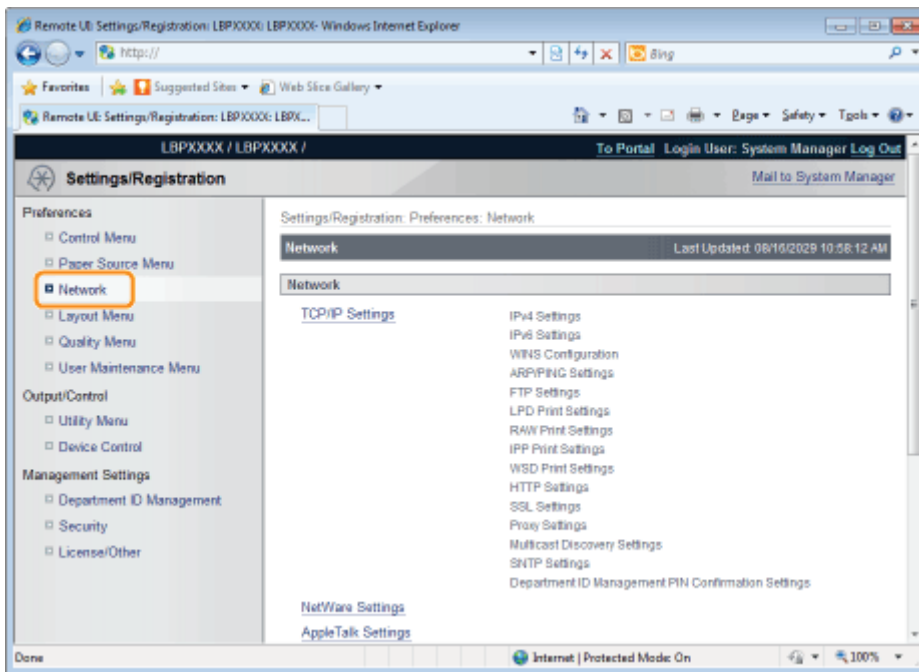

4

Click [AppleTalk Settings].

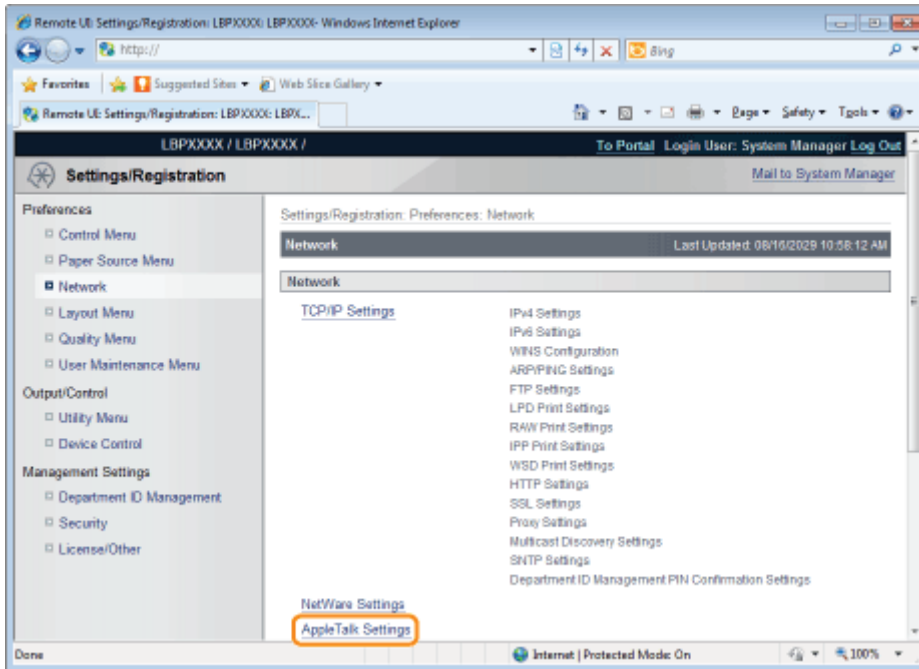

5

Click [Edit...].

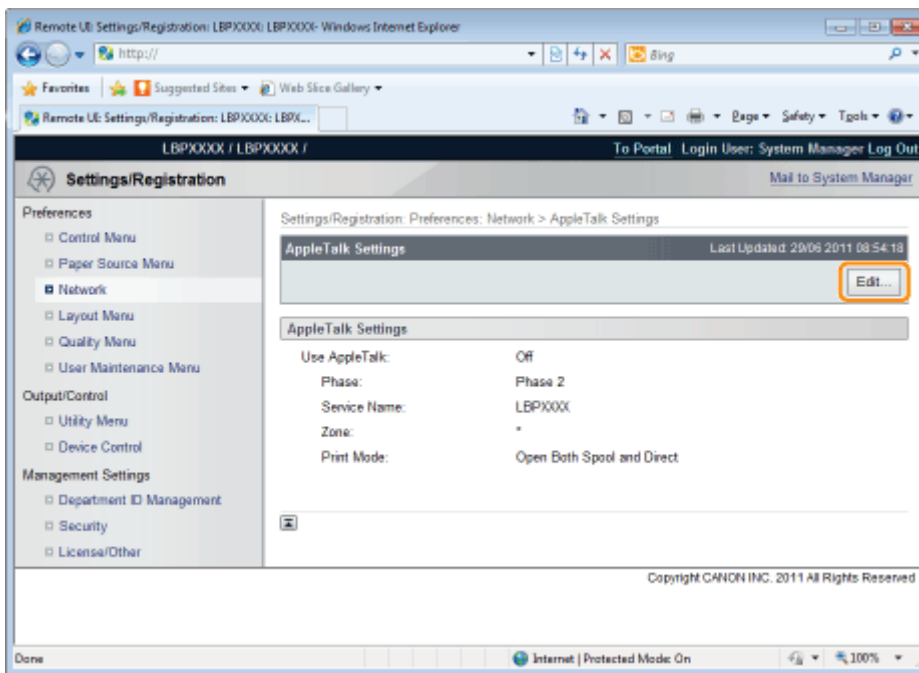

6

Select the [Use AppleTalk] check box.

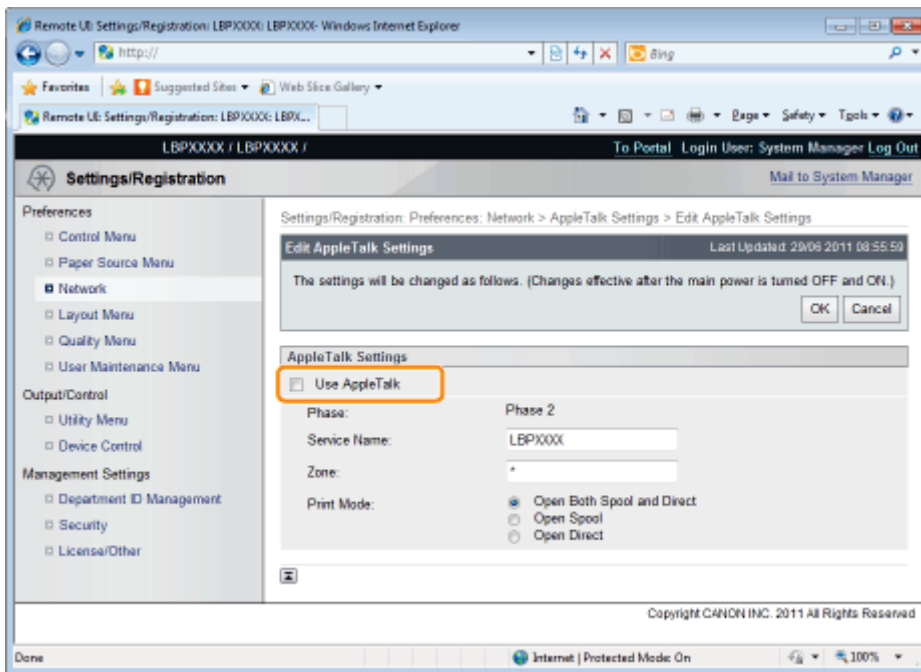

NOTE

When the [Use AppleTalk] check box is cleared

The printer is not detected on the AppleTalk network.

7

Specify the settings for AppleTalk.

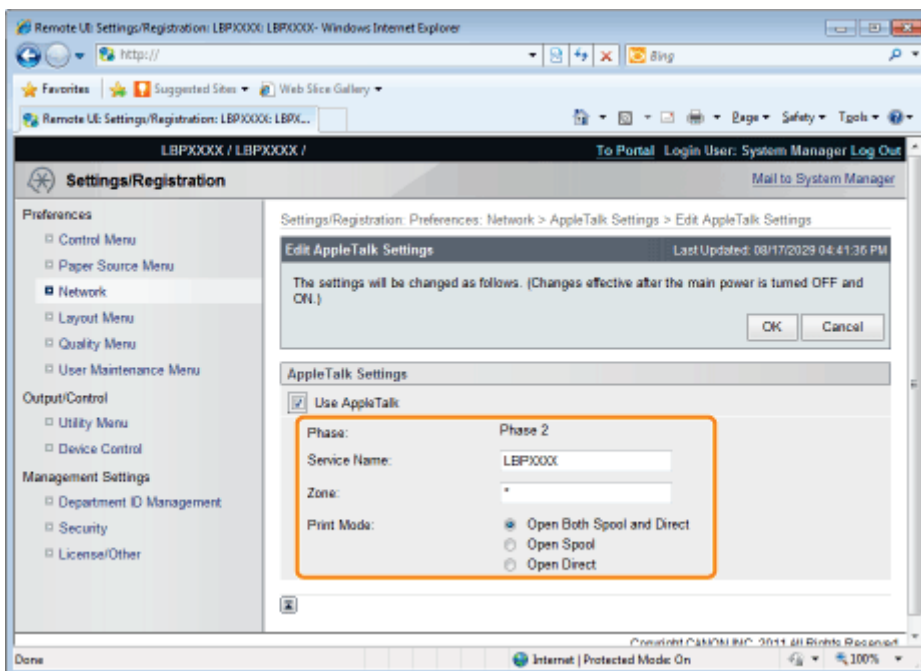

1. Enter the name of the printer in [Service Name]. Up to 32 characters can be entered.

† The name specified in this option is displayed on the printer list of Macintosh.

2. If any zone is set up on the network, enter the zone name in [Zone]. Up to 32 characters can be entered.

3. In [Print Mode], specify a printing process to be used. If you want to fix the printer to be used, select the check box only for the printer.

- [Open Both Spool and Direct]: Prints documents with a choice of "Spool" or "Direct" from the computer.
- [Open Spool]: Prints documents at high speed.

- [Open Direct]: Prints documents at high quality.

IMPORTANT

About [Phase]

[Phase] is fixed at [Phase 2], and you cannot specify the setting.

About [Service Name]

You cannot specify a name which includes "=", "@", "*", ":", and "~."

About [Zone]

You cannot specify a name which includes "=", "@", ":", and "~."

If multiple printers are in the same zone

Specify a specific name for each printer.

[Print Mode]

It is not possible to clear both [Open Spool] and [Open Direct] together.

8

Click [OK].

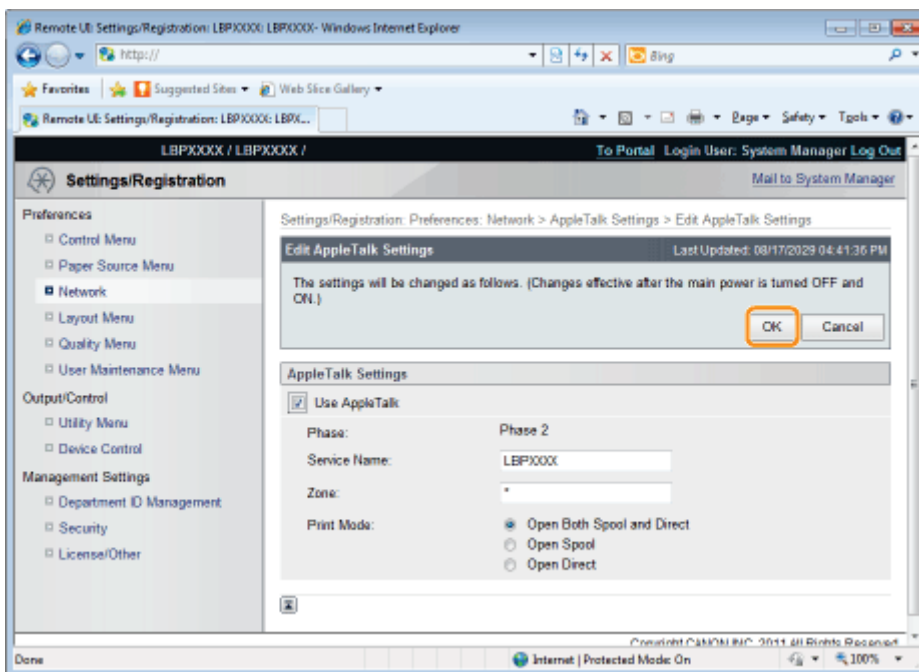

9

Perform a hard reset or restart the printer.

→ After performing a hard reset or restarting the printer, the settings are effective.

NOTE

To perform a hard reset

You can perform a hard reset using the following procedure.

1. Click [Settings/Registration].
2. Select [Device Control] from the [Output/Control] menu.
3. Select [Hard Reset], and then click [Execute].

FTP Client (Macintosh)

04L9-09K

This section describes the procedure for when Terminal supplied with Mac OS X as standard is used.

IMPORTANT

If the [FTP Settings] check box is not selected in the [TCP/IP Settings] page in [Settings/Registration] - [Preferences] - [Network], settings cannot be specified from the FTP client.

➤ ["Configuring the Protocol Settings"](#)

1

Enter "ftp the IP address of the printer", and then press the [return] key on your keyboard.

- **Input Example:** "ftp 192.168.0.215"

If you are not sure about the IP address of the printer

Print and confirm Network Status Print while referring to "[Checking the Printer Settings](#)", or consult your network administrator.

2

Enter "root" as the user name, and then press the [return] key on your keyboard.

3

Enter the administrator password, and then press the [return] key on your keyboard.

† The default password is "7654321".

4

Enter "cd config", and then press the [return] key on your keyboard.

5

Enter "get CONFIG <the file name>", and then press [return] on your keyboard.

† Enter "CONFIG" as all upper case characters.

→ The config file is downloaded.

The characters entered for <the file name> become the name of the downloaded config file.

NOTE

If the config file cannot be found

Search for the config file using the file search function of your operating system.

(The download directory for the config file varies depending on the operating system or settings.)

6

Edit the downloaded config file in "TextEdit" or a similar text editor.

For details on descriptions of each option, see "[Setting Items](#)."

7

Enter "put <the file name> CONFIG", and then press [return] on your keyboard.

† Enter "CONFIG" as all upper case characters.

→ The edited config file uploads.

In <the file name>, enter the name of the config file that was entered when the file was downloaded.

8

Enter "get reset", and then press the [return] key on your keyboard.

When the printer is restarted the settings will be enabled.

After checking that the printer has restarted, press the [c] key while holding down the [Ctrl] key, and return to the ftp command prompt.

9

Enter "quit", and then press the [return] key on your keyboard.

10

Enter "exit", and then press the [return] key on your keyboard.

11

Select [Quit Terminal] from the [Terminal] menu.

Configuring a Computer that Performs Printing

04L9-09L

After completing the protocol settings for the printer, configure each Macintosh to be used for printing.

Installing the Printer Driver

A printer driver is required for printing. Following "Printer Driver Installation Guide", install the printer driver.

† For details on the procedure for viewing "Printer Driver Installation Guide", see "[Installation](#)."

IMPORTANT

The supplied CD-ROM does not include the printer driver for Macintosh.

Download the printer driver for Macintosh that supports this printer from the Canon Web site (<http://www.canon.com/>). If you cannot find the printer driver for Macintosh that supports this printer on the Canon Web site, contact your local authorized Canon dealer.

Setting the Printer Destination

After installing the printer driver, set the printer destination. Following "Driver Guide", set the printer destination.

† For details on the procedure for displaying "Driver Guide", see "[Viewing the Driver Guide](#)."

➤ **Software That Can Be Used for Managing the Printer**

- Remote UI
- FTP Client
- NetSpot Device Installer

➤ **Managing Print Jobs**

➤ **Control Panel Setting**

➤ **Setting Items**

➤ **Checking the Number of the Printed Pages**

➤ **Importing and Exporting Settings**

➤ **Initializing the Settings**

➤ **Checking the Printer Settings**

➤ **Setting the Administrator Password**

➤ **Specifying the Device Name or Administrator Information**

➤ **Sleep Mode**

➤ **Auto Shutdown**

➤ **Printing Silently**

➤ **Specifying an ID for Each Department (LBP6680x Only)**

➤ **Register/Update Software Function (LBP6680x Only)**

Software That Can Be Used for Managing the Printer

04L9-09S

You can manage the printer using the control panel and the following software.

Because the items you can manage differ respectively, use each software according to your environment or the item you want to manage.

For details on the items you can manage using the control panel, see "[Setting Items.](#)"

○: Can be managed

—: Cannot be managed

△: Can be managed partly

Management Item	Control Panel	Remote UI	FTP Client	NetSpot Device Installer
Managing Print Jobs	△	○	—	—
Checking the Number of the Printed Pages	○	○	—	—
Checking the Printer Settings	△	△	△	△
Setting the Administrator Password	—	○	○	—
Specifying the Device Name or Administrator Information	—	○	○	○
Sleep Mode	○	○	—	—
Configuring the Network Settings (Sharing the Printer)	△	○	△	△
Security Settings	△	○	△	—
[Settings/Registration] Menu	○	△	—	—
Specifying an ID for Each Department (LBP6680x Only)	—	○	—	—

The Remote UI allows you to manage the printer using a Web browser.

<Features of the Remote UI>

- **No specific software is needed.**

You can operate the Remote UI in a Web browser. You do not need specific software to operate the Remote UI.

- **You can manage the printer from a remote location.**

By accessing and operating the printer from the Web browser via a network, you can manage the printer using a computer in a remote location.

You can perform various operations, such as checking the current printer status or job logs and specifying various network settings in the Remote UI.

- **Central management of all the printer settings with the administrator password.**

Only the administrator can configure the settings or perform the operations related to the printer management by setting the administrator password.

Before starting the Remote UI, see "[Attention \(Remote UI\)](#)."

▸ [Starting the Remote UI](#)

▸ [Screen Layout of the Remote UI \(Details on Each Setting Page\)](#)

▸ [Display/Change Message Board Messages and Support Links](#)

System Requirements of the Remote UI

Web Browser	Internet Explorer 6 or later Netscape Navigator 6.0 or later
Operating System	An operating system on which the above Web browsers can run
Display	Resolution: 800 x 600 pixels or more Display colors: 256 colors or more

1

Start the Web browser.

2

Enter "http://<the IP address of the printer>/" in the address field, and then press the [ENTER] key on your keyboard.

- **Input Example:** "http://192.168.0.215/"

† If the host name of the printer is registered in the DNS server, you can enter ["host name"."domain name"] instead of the IP address.

- **Input Example:** http://my_printer.xy_dept.company.com/

† If you want to use SSL encrypted communication, enter "https://<the IP address or name of the printer>". If the [Security Alert] dialog box or other dialog box appears, follow the directions in the message.

- **Input Example:** https://192.168.0.215/

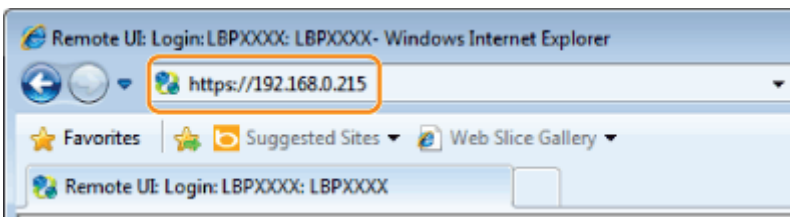

? If the Remote UI top page is not displayed

Check the following points.

- The Remote UI is enabled.
 - ❖ ["Enabling the Remote UI"](#)
- The printer and computer are connected properly via a network.
- The printer is turned ON.
- The IP address or ["host name"."domain name"] is entered correctly.

3

Log in as Administrator or End-User.

❖ [Logging in as Administrator](#)

By logging in as Administrator, you can perform all the operations and settings of the Remote UI.

❖ [Logging in as End-User](#)

By logging in as End-User, you can check the device status, confirm the settings, and view the jobs.

Logging in as Administrator

- (1) Select [Management Mode].
- (2) Enter the password in [Password].

- † The default password is "7654321".
 - ❖ ["Setting the Administrator Password"](#)

(3) Click [Log In].

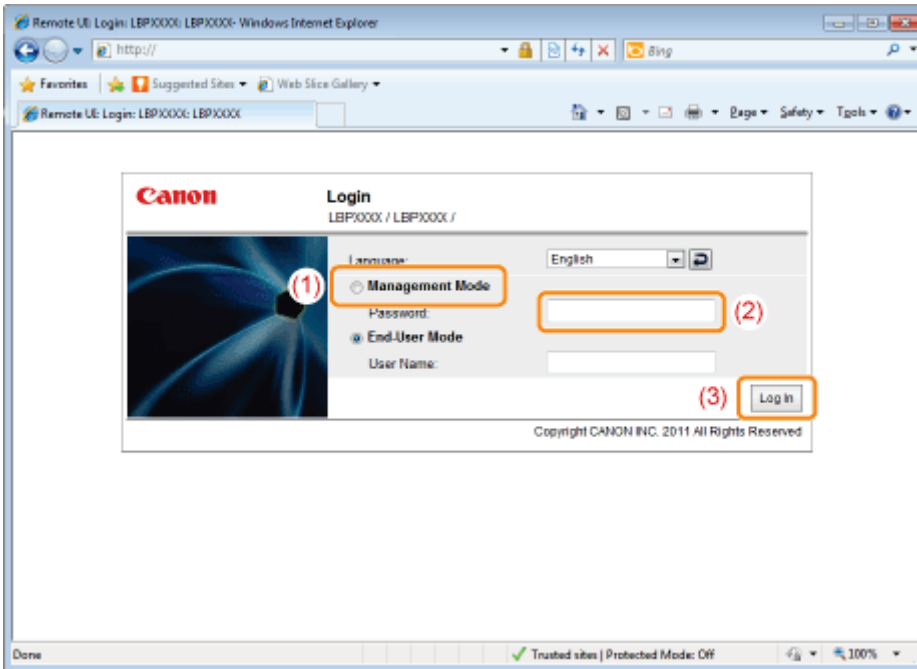

Logging in as End-User

- (1) Select [End-User Mode].
- (2) Enter [User Name] as needed.
- (3) Click [Log In].

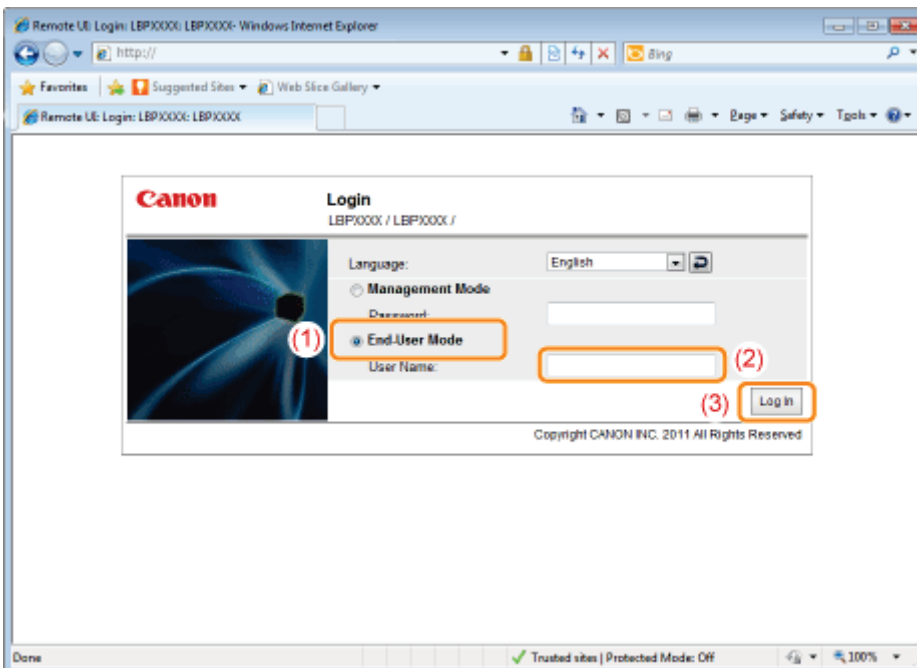

NOTE

About [User Name]

- If you want to log in by entering [User Name], permit job operations by end-users in [Management Settings] in the [Settings/Registration] - [Management Settings] - [Security] page.
- ["Specifying the Job Operation Permission for End-Users"](#)
- Although it is possible to log in without entering any value for [User Name], logging in by entering the user name enables to operate the jobs for which the user names correspond with each other.
- The value to be entered for [User Name] is the user name you entered when logging in to the computer.

About department ID management (LBP680x only)

When the department ID management function is enabled, you can log in by entering the department ID and password.

NOTE

When using SSL encrypted communication

To use SSL encrypted communication, a key and its certificate need to have been created and the key needs to have been registered as the default key.

For details on the SSL encrypted communication function and the procedure for registering a key, see "[Setting Keys and Certificates](#)."

If the Remote UI does not start when SSL is enabled

There is a possibility that the file related to key management is broken. Perform the following procedure.

1. Press [] (: Settings) on the control panel, select [Network] → [Remote UI Settings] → [SSL], and then make sure that [SSL] is set to [Off].
2. Restart the printer.
3. Regenerate the key and certificate and specify the settings for SSL from the Remote UI.
 - "[Setting Keys and Certificates](#)"
4. Restart the printer.

When using a proxy server

If you cannot connect the computer to the printer via a proxy server when using a proxy server, add the IP address of the printer to [Exceptions] (the addresses that do not use the proxy server) on the settings for the proxy server of the Web browser.

The setting varies depending on the network environment. Consult your network administrator.

About Cookies

Configure your Web browser to enable cookies.

Setting priority

For details on the setting priority for when specifying the same item using a method other than the Remote UI as that specified using the Remote UI, see "[Setting Priority \(When Specifying the Same Item Using Multiple Methods\)](#)."

Starting the Remote UI

- If the Remote UI is running on multiple computers at a time, the latest settings are valid.
- If you want to log in as Administrator, we recommend that only one Remote UI should be running at a time.
- You can change language displayed in the login screen from the Setup menu. (LBP6680x only)
 - [\[Setup\] Menu \(\[Control Menu\] Options\)](#)
- The following message may be displayed before the login screen appears depending on your environment. (LBP6680x only)

"Processing... Wait a moment."

Enabling the Remote UI

04L9-09Y

This section describes the procedure for enabling the Remote UI using the printer's control panel.

NOTE

When enabling the Remote UI using software other than the Remote UI

You can also enable the Remote UI using the following software.

FTP Client

You can enable the Remote UI by accessing the FTP server of the printer using Command Prompt.

1

Press [] ( : Settings), select [Network] using [▲] and [▼], and then press [OK].

When the message is displayed, press [OK].

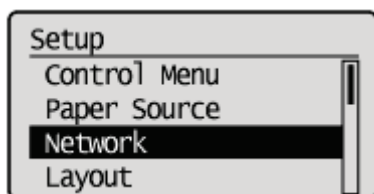

2

Select [Remote UI Settings] using [▲] and [▼], and then press [OK].

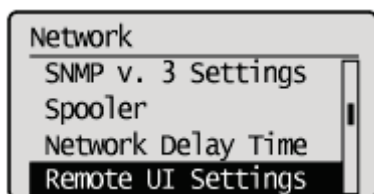

3

Select [Remote UI] using [▲] and [▼], and then press [OK].

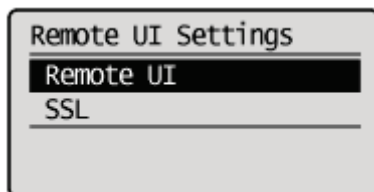

4

Select [On] using [▲] and [▼], and then press [OK].

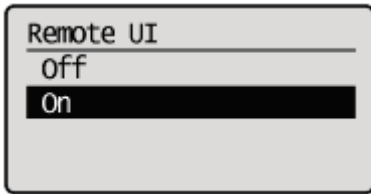

5

Perform a hard reset or restart the printer.

After performing a hard reset or restarting the printer, the settings are effective.

 **NOTE**

For details on a hard reset

See "[Canceling All the Jobs \(Hard Reset\)](#)."

Screen Layout of the Remote UI (Details on Each Setting Page)

04L9-0A0

Remote UI Portal Page

The screen shown below, which is displayed when the Web browser is launched and you have logged in to the Remote UI, is called the Portal Page.

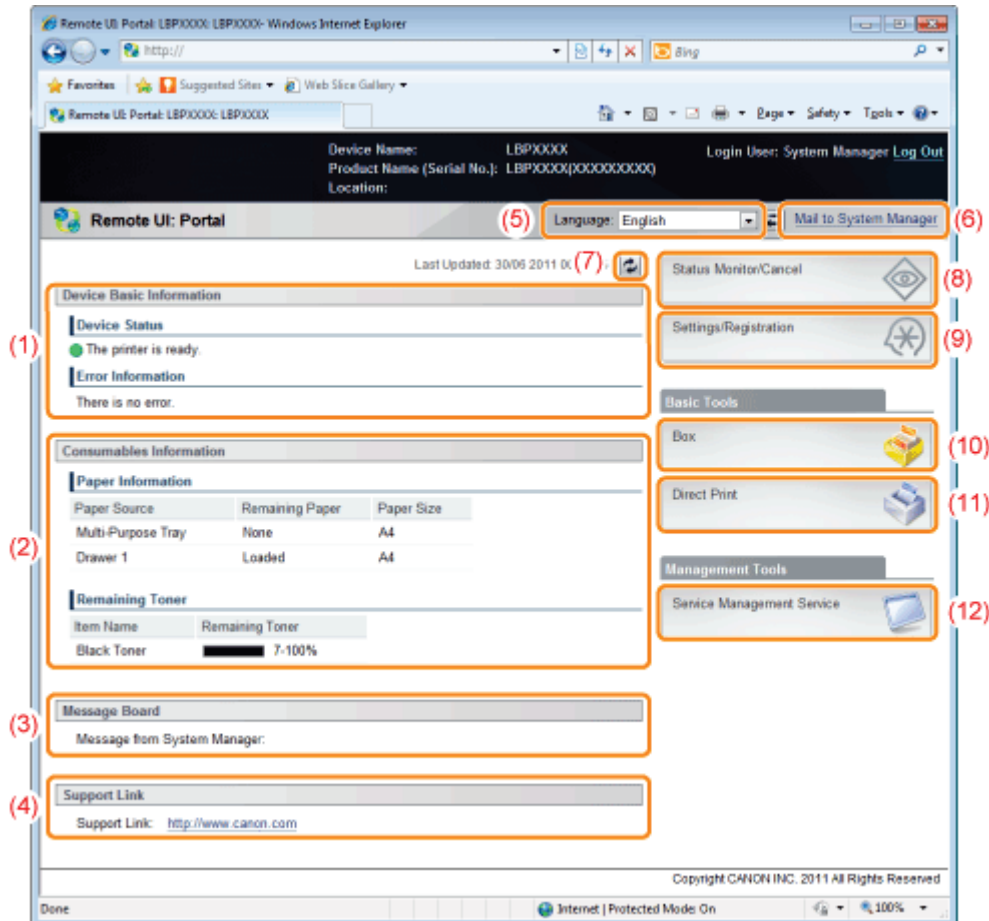

(1) [Device Basic Information] [Device Status]

The indicators and status messages show the current printer status. You can see the status of the printer from the indicator colors, as shown below.

Indicator Color	Printer Status	Solution
● (Gray):	Offline (not accepting print data)	Go back online and print.
● (Green):	Normal status (able to print)	
● (Yellow):	There is no printing trouble, but some type of action is required (a warning message is displayed)	Follow the onscreen instructions shown in [Error Information] below and solve the problem.
● (Red):	Printing is not possible for some reason (an error message is displayed)	

[Error Information]



It displays error information generated by the printer.

(2) [Consumables Information] [Paper Information]

It displays paper level, size and type for each of the paper sources.

[Remaining Toner]

It displays the amount remaining in the toner cartridge.

Item Name	Remaining Toner ^{*1}	Status	Solution
Toner Cartridge	7-100%	Able to print	-
	1-7% ^{*2}	The toner cartridge needs to be replaced soon	<ul style="list-style-type: none"> • Printing will continue or stop.^{*3} • If printing has stopped, press [] ( : Online) on the printer control panel and printing will continue. • Have a replacement toner cartridge ready. • We recommend that you replace the toner cartridge before doing a large amount of printing. <p>➤ "Replacing the Toner Cartridge"</p>
	0%	The toner cartridge has reached the end of its life	<ul style="list-style-type: none"> • You can continue the print job, but doing so may cause the printer to malfunction. Therefore, we recommend that you replace the toner cartridge with a new one. <p>➤ "Replacing the Toner Cartridge"</p>
	<Insert Cartridge>	The toner cartridge is not installed	<ul style="list-style-type: none"> • Install the toner cartridge properly.

*1 The remaining amount displayed is just a rough indication, and may be different from the actual amount.

*2 Depending on the type of toner cartridge that you are using, "1-21%" may be displayed on the screen.

*3 Whether the printer continues or stops printing when the toner cartridge needs to be replaced soon depends on the setting for [Warning Step] in the [Setup] menu.

➤ ["\[Setup\] Menu \(\[Control Menu\] Options\)"](#)

(3) [Message Board]

It displays messages from the administrator.

➤ ["Display/Change Message Board Messages and Support Links"](#)

(4) [Support Link]

It displays links to information concerning printer support.

➤ ["Display/Change Message Board Messages and Support Links"](#)

(5) [Language]

You can change the screen display language from the drop-down list.

(6) [Mail to System Manager]

You can send e-mail to the system manager.

(7) Update Button

Refresh the portal page display to the latest status.

(8) [Status Monitor/Cancel]

You can check and change the status of jobs the printer is processing. You can also check device status.

➤ ["\[Status Monitor/Cancel\] Menu"](#)

(9) [Settings/Registration]

You can set/change the various printer settings. The items that can be set/changed differ depending on whether you log in as administrator or end user.

➤ ["\[Settings/Registration\] Menu"](#)

(10) [Box] (LBP6680x only)

When the optional SD card is installed, you can print, copy and send documents that are saved in the printer's box.

(11) [Direct Print]

Using the printer, you can print PDF files, PS/EPS files, image files and XPS files that are saved to the computer you are using as is, without opening them.

➤ ["Printing without the Printer Driver \(Direct Print\)"](#)

(12) [Service Management Service] (LBP6680x only)

It displays the SMS (Service Management Service) screen.

➤ ["MEAP \(LBP6680x Only\)"](#)

[Status Monitor/Cancel] Menu

The following pages are in the [Status Monitor/Cancel] menu.

- ❖ Print: [Job Status] Page
- ❖ Print: [Job History] Page
- ❖ E-Mail RX: [Job History] Page
- ❖ [Error Information] Page
- ❖ [Device Features] Page
- ❖ [Device Information] Page
- ❖ [Check Counter] Page

Print: [Job Status] Page

You can check the status of jobs that are currently printing and manage them using cancel/resume.

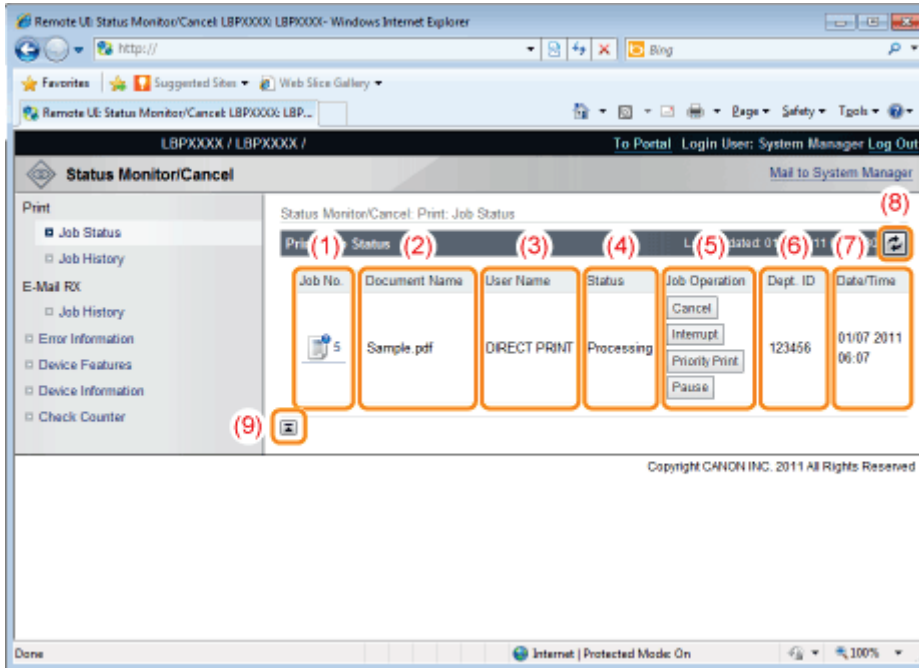

(1) [Job No.]

The Job No. of the job is displayed. When you click the Job No., the job's details are displayed.

(2) [Document Name]

The name of the job is displayed. For e-mail printing jobs, the subject of the e-mail is displayed.

(3) [User Name]

The user name of the job is displayed. For e-mail printing jobs, the e-mail sender is displayed.

(4) [Status]

The status of the job is displayed.

(5) [Job Operation]

It runs the job operation. Click the button for the operation that you want to run.

- ❖ "Managing Print Jobs"

[Cancel]	It cancels the printing of the job that you clicked on and deletes the job.
----------	---

When the SD card is installed, you can run the following operations. (LBP6680x only)

[Interrupt]	It pauses the job that is currently being output, and makes the new job the printing priority. When the new job is finished printing, it resumes printing the paused job.
[Priority Print]	The output order of the job is moved up by one.
[Pause]/[Resume]	When you click [Pause], it pauses the job output. The button for the paused job changes to [Resume]. When you click [Resume], the paused job resumes. The button for the resumed job goes back to [Pause].

 **NOTE**

[Job Operation]

When logged on in End-User mode, it is possible to operate jobs with user names that match using [Management Settings] of [Settings/Registration] - [Management Settings] - [Security] only when job operation by end users is permitted.

- (6) **[Dept. ID]**
If department ID is set, the department ID for the job is displayed. (LBP6680x only)
- (7) **[Date/Time]**
The date and time the job was input is displayed.
- (8) **Update Button**
It refreshes the [Job Status] page display to the latest status.
- (9) **[Back to Page Top]**
It moves the scroll box up to the top of the page.

Print: [Job History] Page

The Print Job/Direct Print, saved job, report printing and e-mail Job History are displayed.

 **NOTE**

[Job History] Page Display

It is possible to display Job History only when displaying job history is permitted by [Display Job History] of [Settings/Registration] - [Management Settings] - [Security].

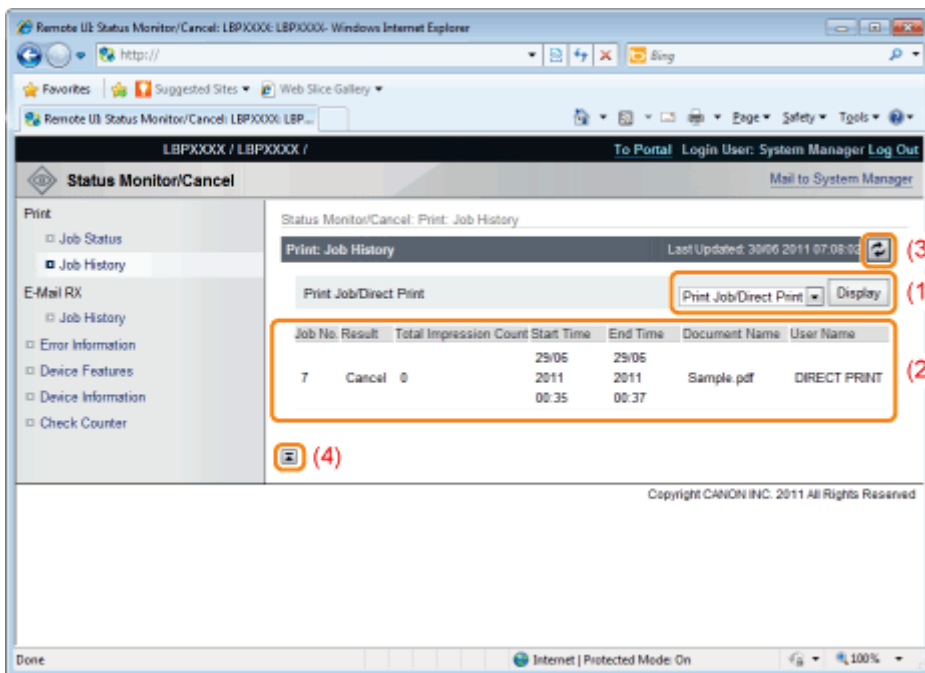

- (1) **Display Toggling**
Select the job history to display. Only the selected type of job history is displayed in the list.
 - [Print Job/Direct Print]
 - [Stored Job] (LBP6680x only)
 - [Report]
 - [E-Mail Print]
- (2) **Display Job History**
The output job history list is displayed.
- (3) **Update Button**
It refreshes the [Job History] page display to the latest status.
- (4) **[Back to Page Top]**
It moves the scroll box up to the top of the page.

E-Mail RX: [Job History] Page

It displays the received e-mail history.

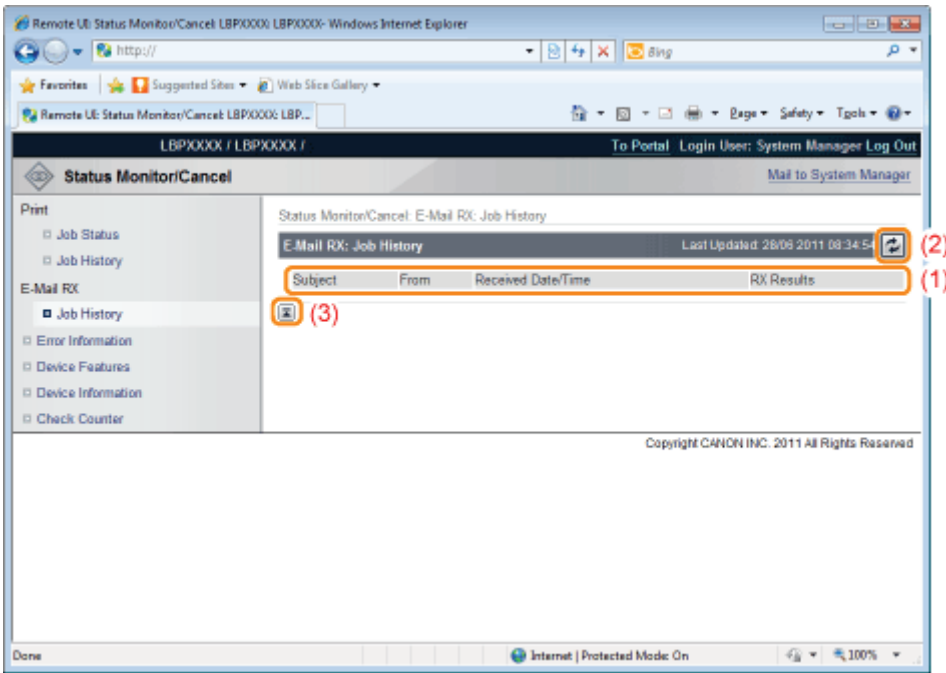

(1) Display Job History

The received e-mail history list is displayed.

(2) Update Button

It refreshes the [Job History] page display to the latest status.

(3) [Back to Page Top]

It moves the scroll box up to the top of the page.

[Error Information] Page

Information about errors occurring in the printer is displayed.

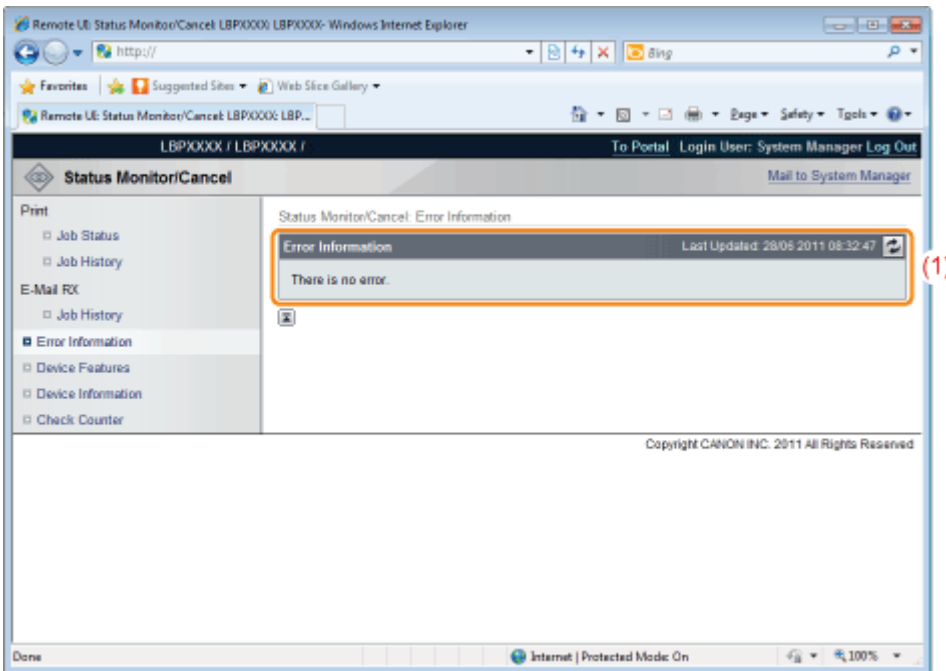

(1) [Error Information] (Number of Errors)

It displays whether or not errors have occurred, and if there are errors, the number of errors.

(2) [Error Information] (Information)

It displays status and solutions for the error information occurring in the printer.
The meanings of the displayed icons are shown below.

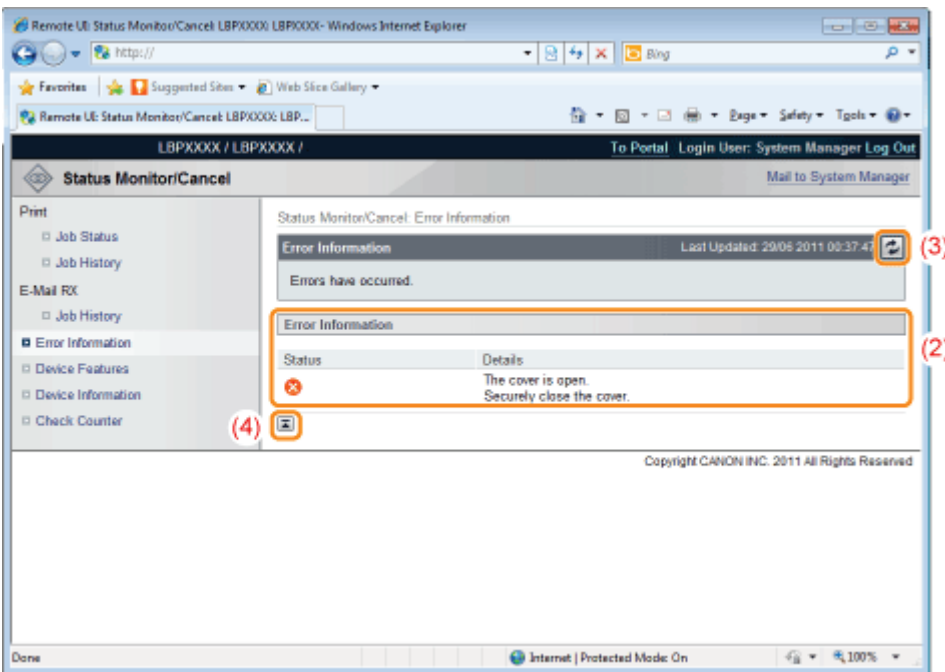

(3) Update Button

It refreshes the [Error Information] page display to the latest status.

(4) [Back to Page Top]

It moves the scroll box up to the top of the page.

[Device Features] Page

The printer equipment information and the functions that can be used in the current equipment status are displayed.

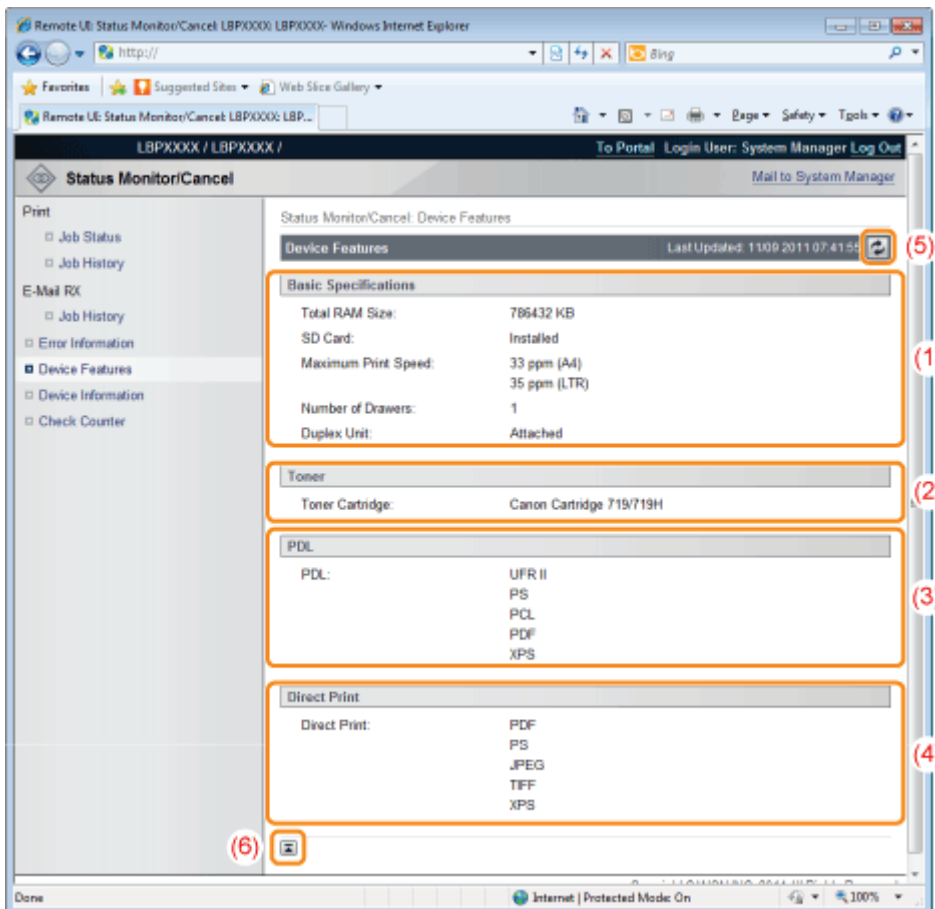

(1) [Basic Specifications]

The amount of RAM installed in the printer console, the installed options and the basic printing performance are displayed.

(2) [Toner]

Information about the toner cartridges installed in the printer is displayed.

- (3) **[PDL]**
The page description languages that can be used by the printer are displayed.
- (4) **[Direct Print]**
The file formats and document formats that can be used by Direct Print are displayed.
- (5) **Update Button**
It refreshes the [Device Features] page display to the latest status.
- (6) **[Back to Page Top]**
It moves the scroll box up to the top of the page.

[Device Information] Page

The basic information about the printer and the system manager information are displayed.

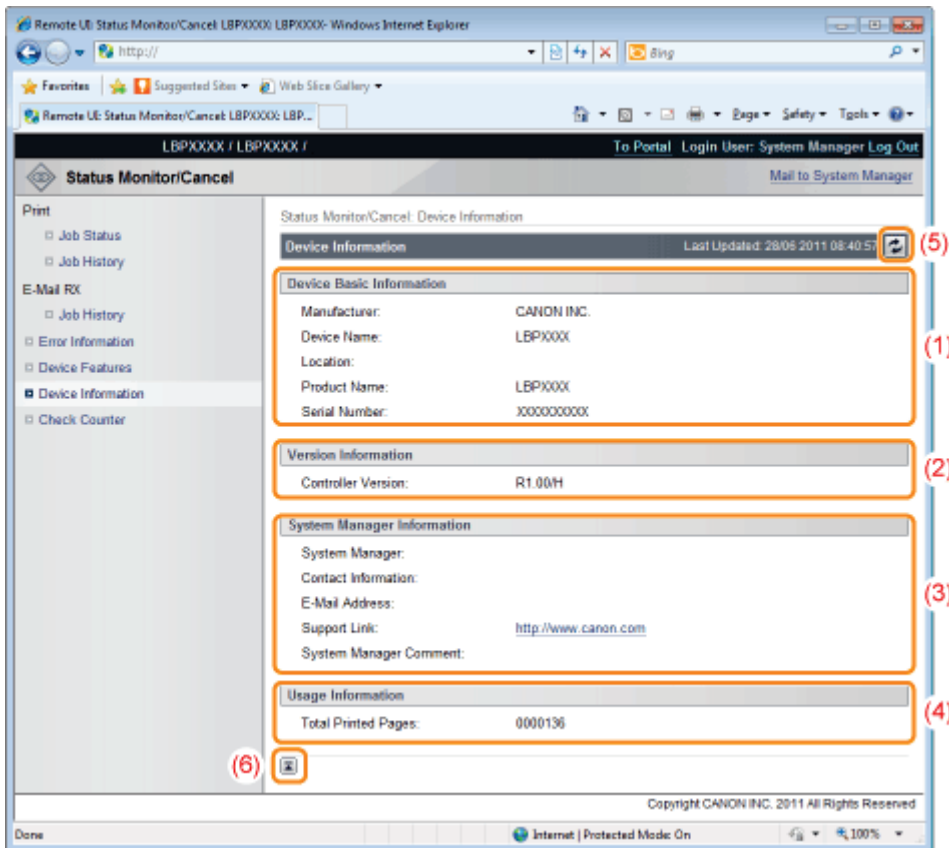

- (1) **[Device Basic Information]**
The basic information about the printer is displayed.
- (2) **[Version Information]**
The printer controller version is displayed.
- (3) **[System Manager Information]**
Information about the registered system manager is displayed.
- (4) **[Usage Information]**
The number of pages printed and the date of the last maintenance are displayed.
- (5) **Update Button**
It refreshes the [Device Information] page display to the latest status.
- (6) **[Back to Page Top]**
It moves the scroll box up to the top of the page.

[Check Counter] Page

The number of pages printed is displayed.

- ❖ "Checking the Number of the Printed Pages"

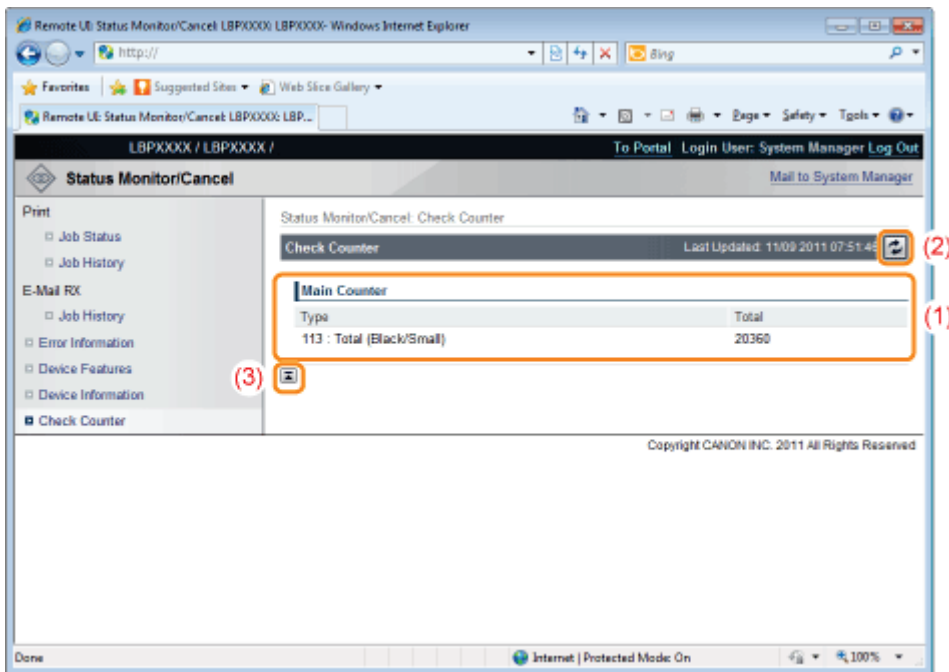

- (1) **[Main Counter]**
The number of pages printed for each counter is displayed.
- (2) **[Update Button]**
It refreshes the [Check Counter] page display to the latest status.
- (3) **[Back to Page Top]**
It moves the scroll box up to the top of the page.

[Settings/Registration] Menu

The following pages show the settings that can be checked using the [Settings/Registration] menu.

[Preferences]

- ❖ [Control Menu] Page
- ❖ [Paper Source Menu] Page
- ❖ [Network] Page
- ❖ [Layout Menu] Page
- ❖ [Quality Menu] Page
- ❖ [User Maintenance Menu] Page

[Output/Control]

- ❖ [Utility Menu] Page
- ❖ [Device Control] Page

[Management Settings]

- ❖ [Department ID Management] Page (LBP6680x Only)
- ❖ [Security] Page
- ❖ [License/Other] Page/[Message Board/Support Link] Page

[Control Menu] Page

It displays the operation settings for energy-saving mode (Sleep Mode) and when errors occur.

For details on the settings, see "[Setup] Menu ([Control Menu] Options)."

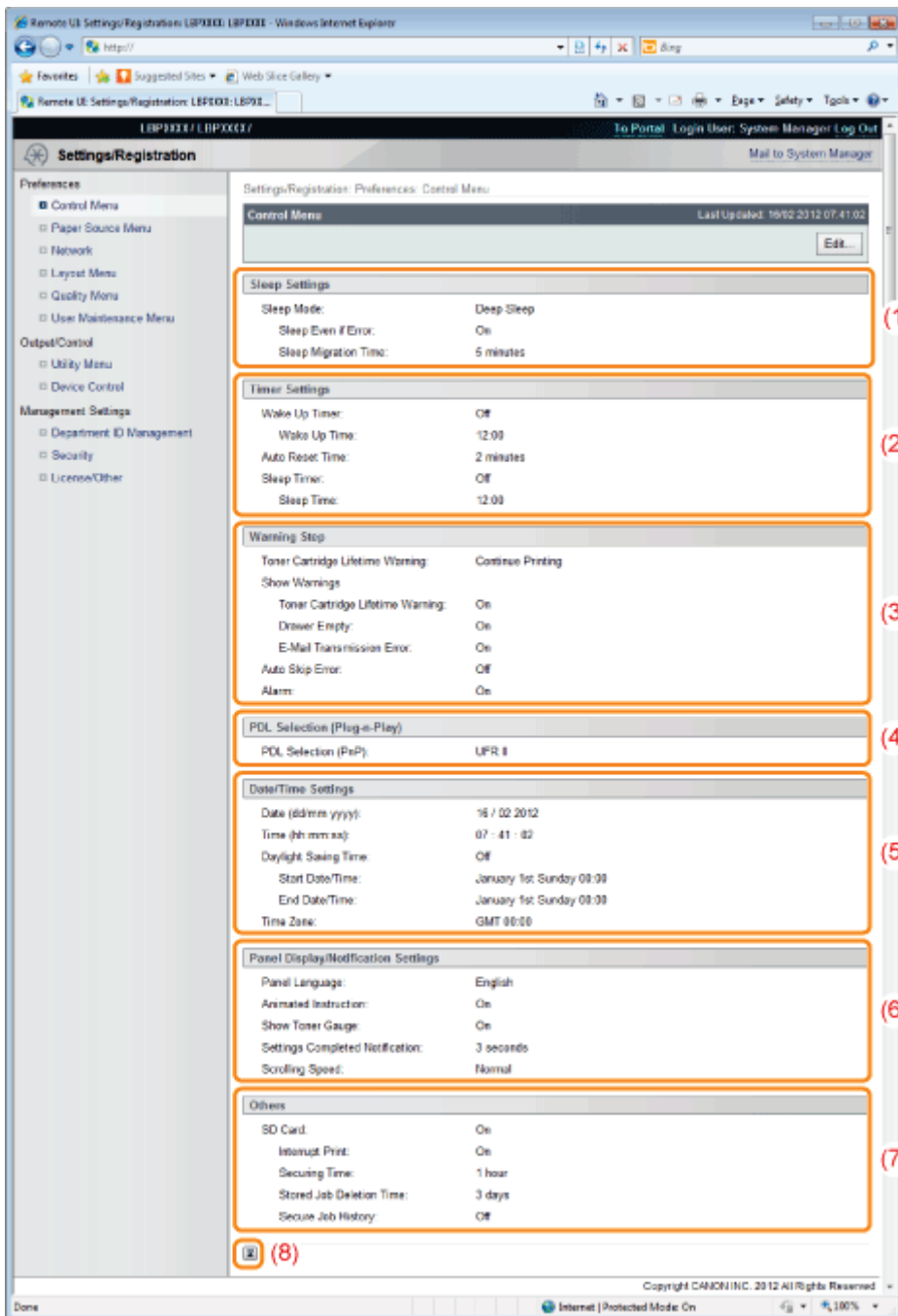

- (1) **[Sleep Settings]**
The settings related to sleep mode operation are displayed.
- (2) **[Timer Settings]**
The settings related to timer operation are displayed.
- (3) **[Warning Step]**
The settings related to warning display are displayed.
- (4) **[PDL Selection (Plug-n-Play)]**
The currently selected page description language is displayed.
- (5) **[Date/Time Settings]**
The settings related to date and time are displayed.
- (6) **[Panel Display/Notification Settings]**
The settings related to control panel display are displayed.
- (7) **[Others]**
Other operation settings not included in the above categories are displayed.
- (8) **[Back to Page Top]**
It moves the scroll box up to the top of the page.

Changing Settings

You can only change settings when you are logged on in system manager mode.

[Paper Source Menu] Page

It displays the settings for paper size, etc. when printing from the multi-purpose tray or paper drawer. For details on the settings, see "[Setup] Menu ([Paper Source] Options)" or "[Select Feeder] Menu."

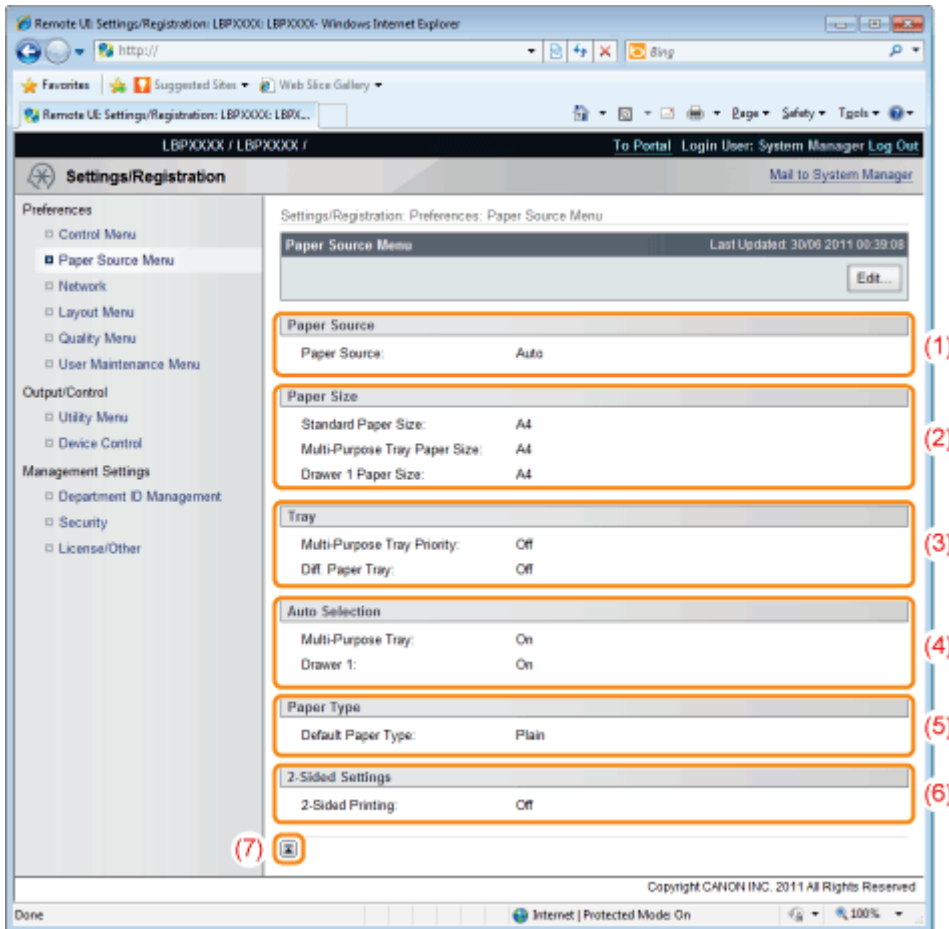

(1) [Paper Source]

The currently selected paper source is displayed.

(2) [Paper Size]

The paper size selected for each paper source is displayed.

(3) [Tray]

The operation settings related to the multi-purpose tray are displayed.

(4) [Auto Selection]

It displays whether to recognize the paper source for auto selection when [Auto] is set for [Paper Source] for each paper source.

(5) [Paper Type]

The paper type selected for each paper source is displayed.

(6) [2-Sided Settings]

The settings related to 2-sided printing are displayed.

(7) [Back to Page Top]

It moves the scroll box up to the top of the page.

NOTE

Changing Settings

You can only change settings when you are logged on in system manager mode.

[Network] Page

It displays the printer's network settings, etc.

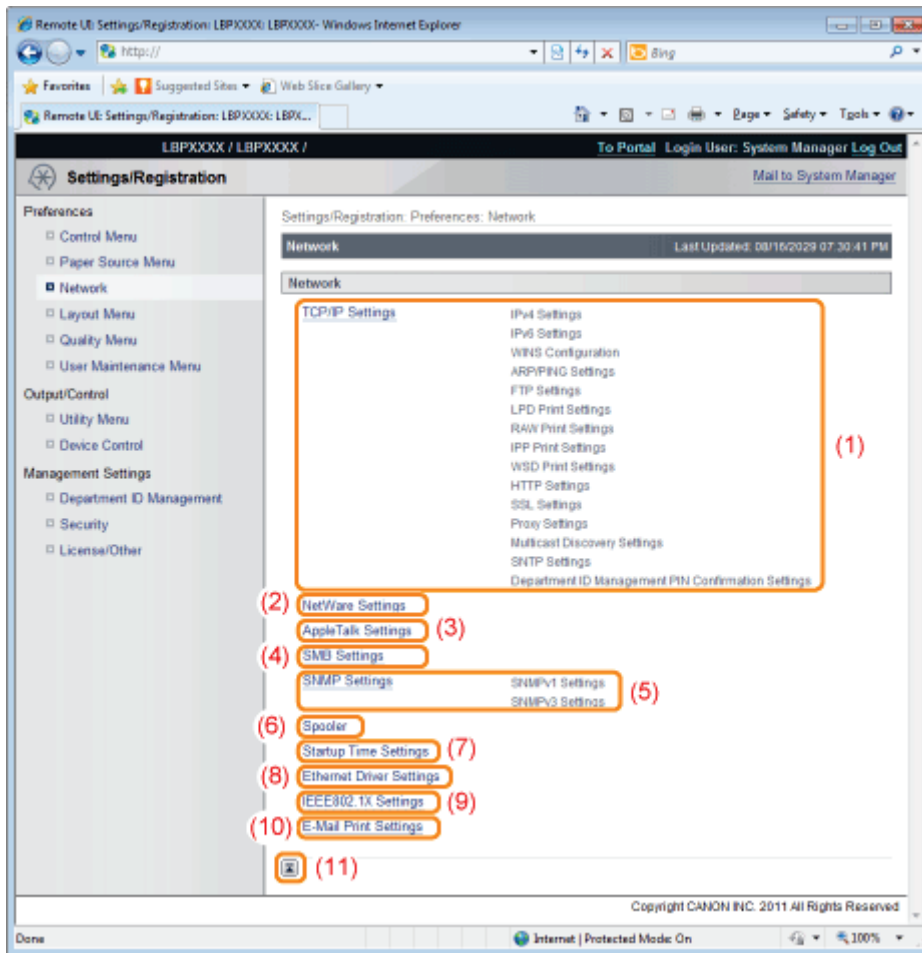

(1) [TCP/IP Settings]

It displays the TCP/IP settings.

- † How to change settings
 - "Configuring the Protocol Settings"

(2) [NetWare Settings] (LBP6680x only)

It displays the NetWare settings.

- † How to change settings
 - "Network Settings for the Printer (NetWare) (LBP6680x Only)"

(3) [AppleTalk Settings]

It displays the AppleTalk settings.

- † How to change settings
 - "Configuring the Protocol Settings"

(4) [SMB Settings] (LBP6680x only)

It displays the SMB settings.

- † How to change settings
 - "Network Settings for the Printer (SMB) (LBP6680x Only)"

(5) [SNMP Settings]

It displays the SNMP settings.

- † How to change settings
 - "Restricting the Users Who Can Monitor/Change the Settings Using the SNMP Protocol"

(6) [Spooler] (LBP6680x only)

It displays the spool function settings when the SD card is installed.

- † How to change settings
 - "Setting the Spooling Function (LBP6680x Only)"

(7) [Startup Time Settings]

It displays the startup time settings.

- † How to change settings
 - ["Specifying the Setting for Startup Waiting Time"](#)

(8) [Ethernet Driver Settings]

It displays the network interface settings.

- † How to change settings
 - ["Changing the Network Transmission Speed or Transfer Mode"](#)

(9) [IEEE802.1X Settings]

It displays IEEE802.1X security settings.

- † How to change settings
 - ["Setting IEEE802.1X Authentication"](#)

(10) [E-Mail Print Settings]

It displays the e-mail print settings.

- † How to change settings
 - ["Receiving E-mail Data on the Mail Server and Printing \(E-mail Print\)"](#)

(11) [Back to Page Top]

It moves the scroll box up to the top of the page.

NOTE

Changing Settings

You can only change settings when you are logged on in system manager mode.

[Layout Menu] Page

It displays the settings relating to print appearance, such as adjustment of print position and setting gutter margins.

For details on the settings, see "[Setup] Menu ([Layout] Options)."

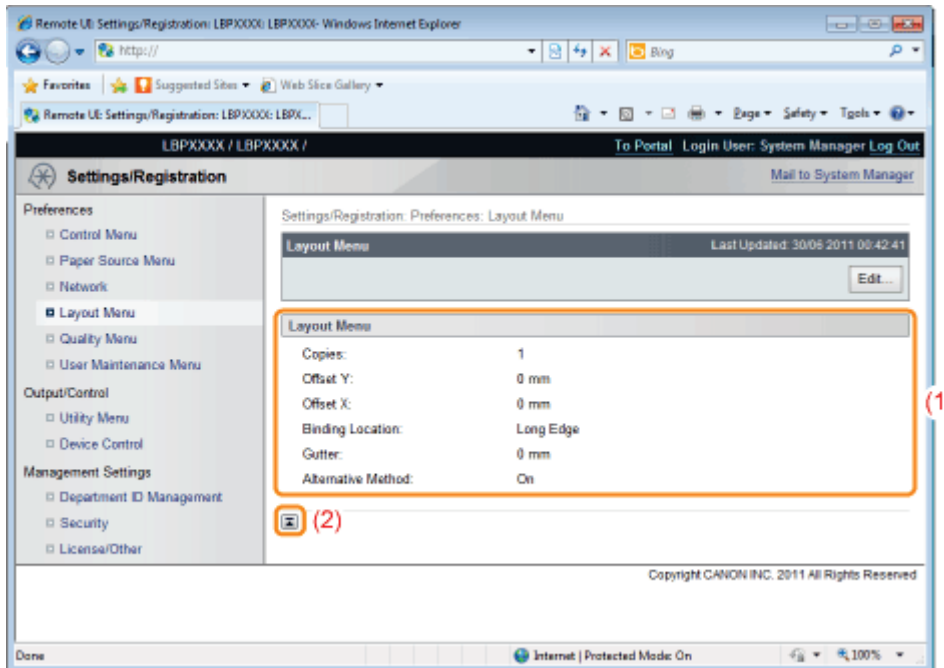

(1) [Layout Menu]

The settings for number of pages and print appearance are displayed.

(2) [Back to Page Top]

It moves the scroll box up to the top of the page.

NOTE

Changing Settings

You can only change settings when you are logged on in system manager mode.

[Quality Menu] Page

It displays the settings related to print quality, such as toner density adjustment.
For details on the settings, see "[Setup] Menu ([Quality] Options)."

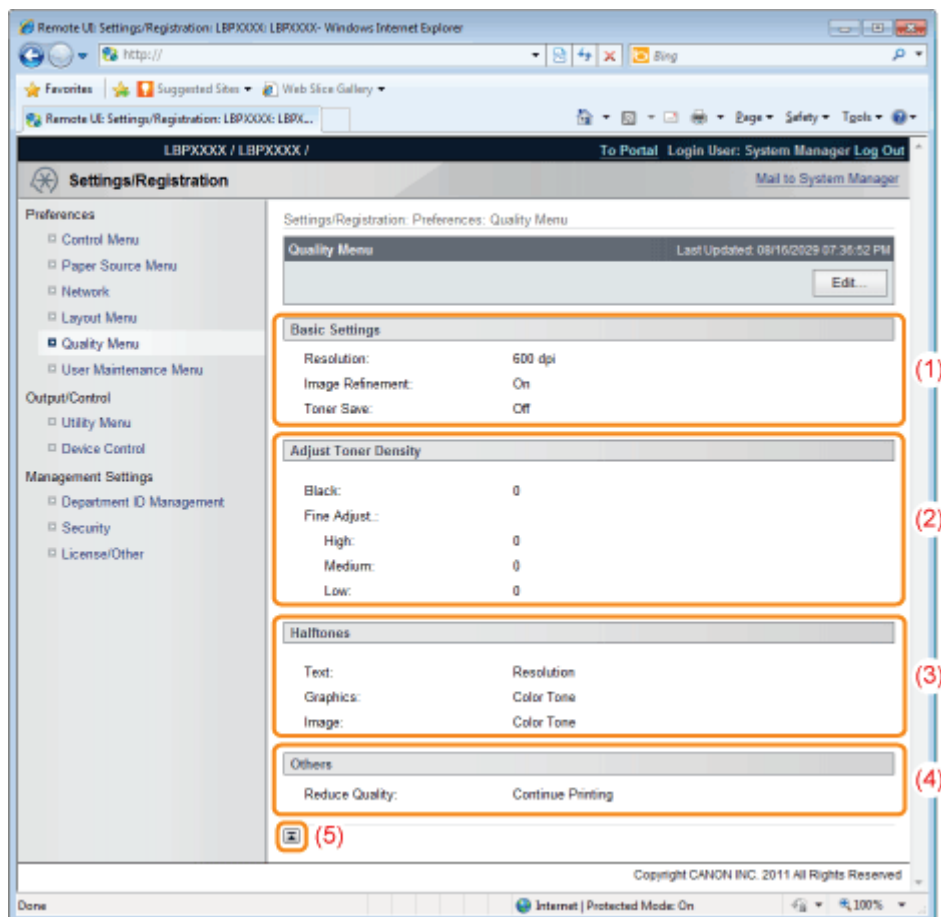

(1) [Basic Settings]

It displays the settings related to printing resolution and toner.

(2) [Adjust Toner Density]

Display the fine-tuned toner density.

(3) [Halftones]

It displays the settings related to halftone representation method when printing.

(4) [Others]

The settings related to other print quality are displayed.

(5) [Back to Page Top]

It moves the scroll box up to the top of the page.

[User Maintenance Menu] Page

It displays the settings for printer adjustment from a specified paper source if a problem occurs, such as adjustment of print position and recovery printing.

For details on the settings, see "[Setup] Menu ([User Maintenance] Options)."

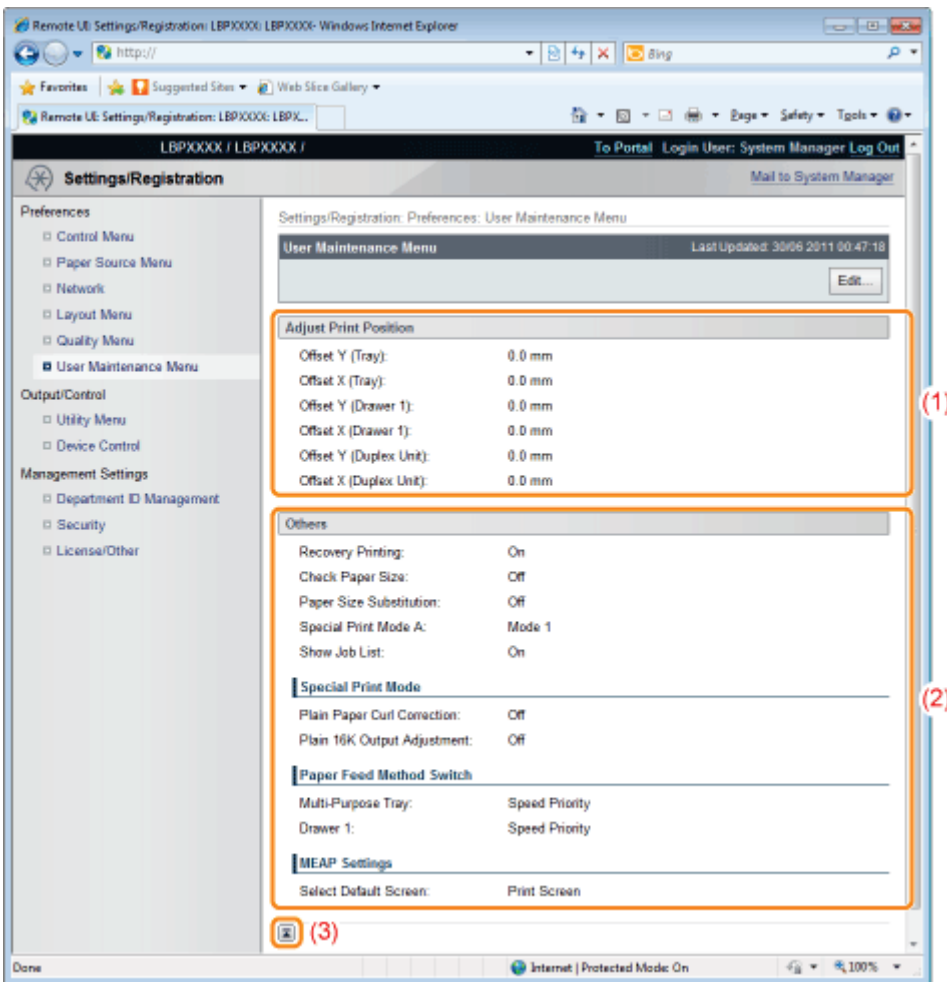

(1) [Adjust Print Position]

It displays the print position adjustment settings for each paper source.

(2) [Others]

It displays the settings for operation and maintenance if a problem occurs.

(3) [Back to Page Top]

It moves the scroll box up to the top of the page.

NOTE

Changing Settings

You can only change settings when you are logged on in system manager mode.

[Utility Menu] Page

You can print each type of management report. Select the item to output, and then click [Execute].

For details on the settings, see "[Utility Menu] Menu."

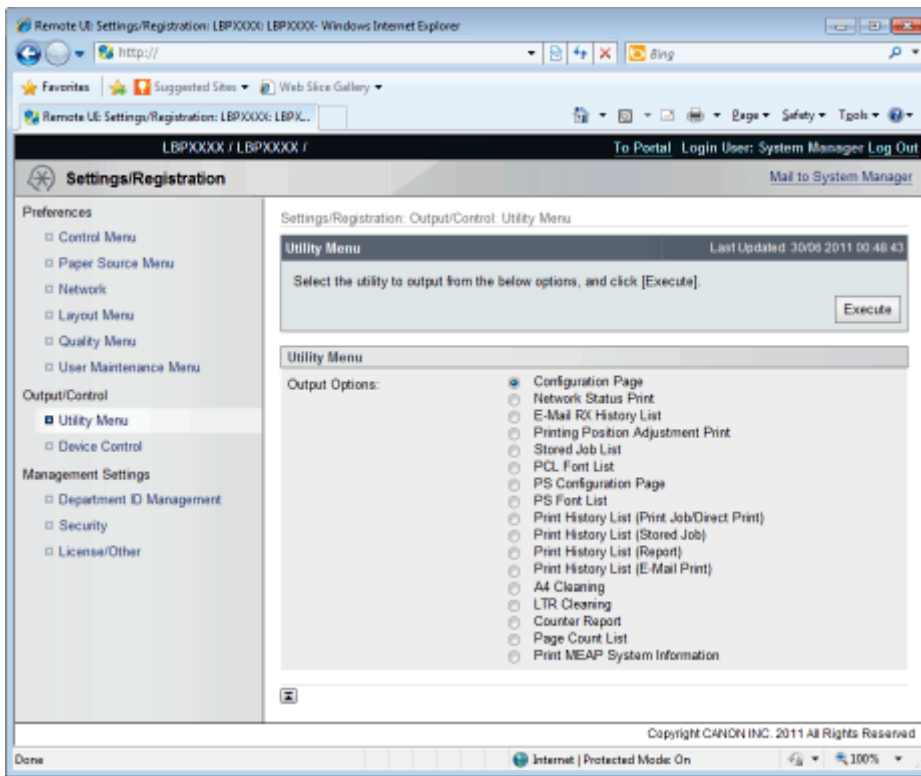

The following management reports can be output.

- Configuration Page
- Network Status Print
- E-Mail RX History List
- Printing Position Adjustment Print
- Stored Job List (LBP6680x only)*
- PCL Font List
- PS Configuration Page (LBP6680x only)
- PS Font List (LBP6680x only)
- Print History List (Print Job/Direct Print)
- Print History List (Stored Job) (LBP6680x only)*
- Print History List (Report)
- Print History List (E-Mail Print)
- A4 Cleaning
- LTR Cleaning
- Counter Report
- Page Count List (LBP6680x only)
- Print MEAP System Information (LBP6680x only)

* Only when the optional SD card is installed

[Device Control] Page

It controls the printer. Select the item to run, and then click [Execute].

For details on the settings, see "[Reset] Menu" or "Basic Printer Operations."

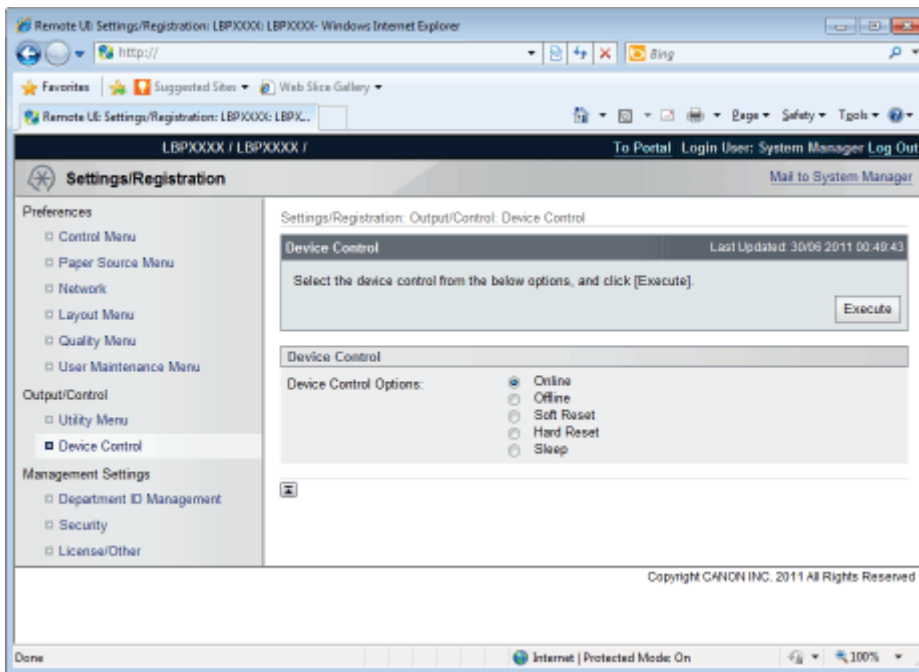

[Department ID Management] Page (LBP6680x Only)

If department ID management is set, it displays the number of pages printed by each registered department.

For details on the settings, see "[Specifying an ID for Each Department \(LBP6680x Only\)](#)."

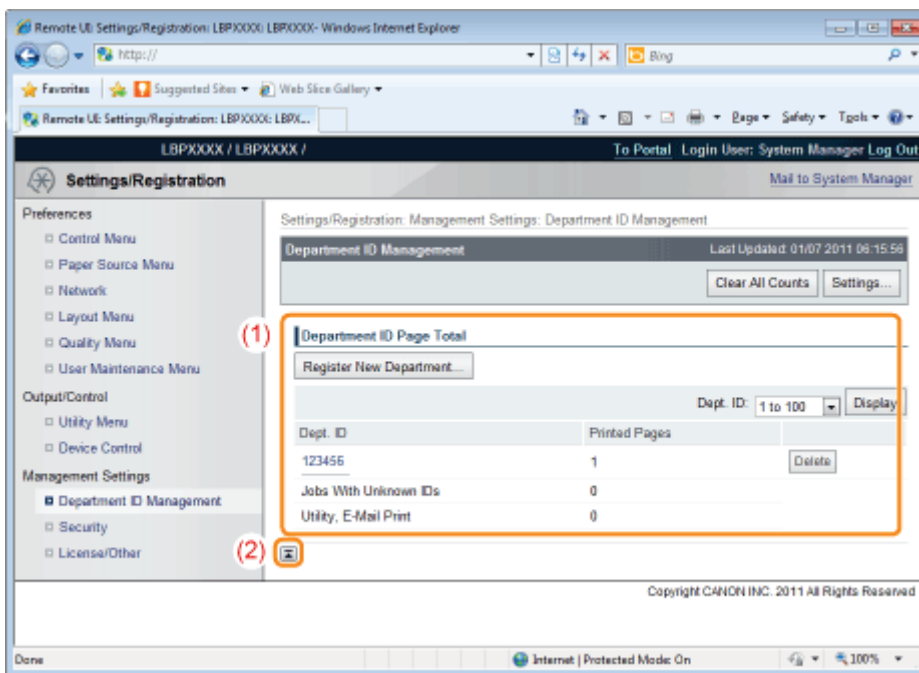

(1) [Department ID Page Total]

It displays the number of pages printed by each department.

(2) [Back to Page Top]

It moves the scroll box up to the top of the page.

[Security] Page

It displays printer information and security settings.

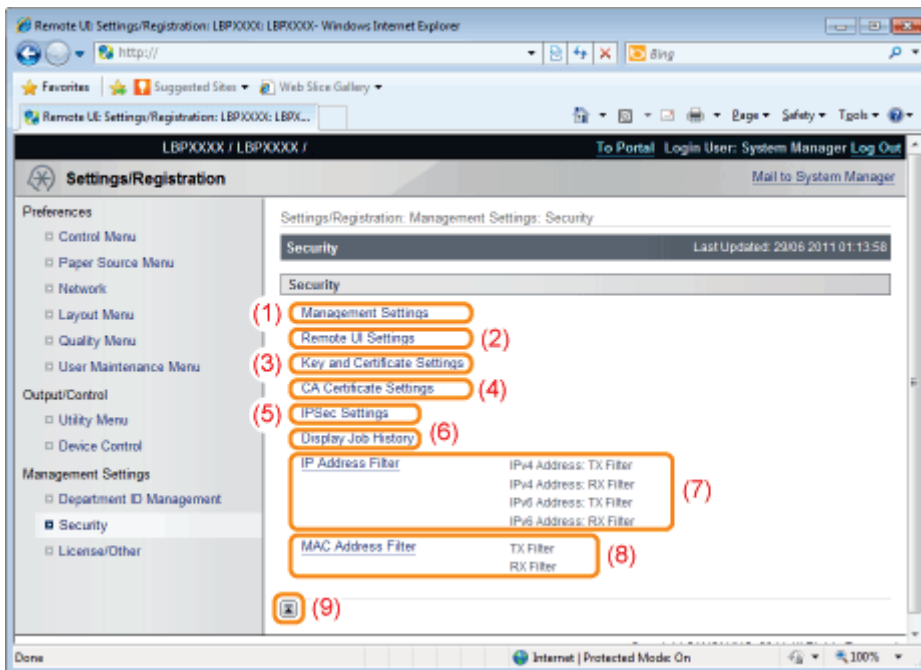

(1) [Management Settings]

It displays general information about the printer.

- ↑ How to change settings
 - ❖ "Setting the Administrator Password"
 - ❖ "Specifying the Device Name or Administrator Information"
 - ❖ "Setting Restrictions for Print Jobs"
 - ❖ "Specifying the Job Operation Permission for End-Users"
 - ❖ "Locking the Keys on the Control Panel (Key Lock Function)"
 - ❖ "Setting Restrictions for USB Direct Print (LBP6680x Only)"

(2) [Remote UI Settings]

It displays whether the Remote UI is set to use the SSL encrypted communication function.

- ↑ How to change settings
 - ❖ "Changing the Remote UI Settings"

(3) [Key and Certificate Settings]

It displays information on registered keys and certificates.

- ↑ How to change settings
 - ❖ "Displaying the [Key and Certificate Settings] Page in the Remote UI"

(4) [CA Certificate Settings]

It displays information on registered keys and certificates.

- ↑ How to change settings
 - ❖ "Displaying the [CA Certificate Settings] Page in the Remote UI"

(5) [IPSec Settings] (LBP6680x only)

It displays the IPSec security policy list.

- ↑ How to change settings
 - ❖ "Setting the IPSec Encryption Communication Function (LBP6680x Only)"

(6) [Display Job History]

It displays whether it is set to allow job history to be displayed.

- ↑ How to change settings
 - ❖ "Specifying the Setting for Job Log Display"

(7) [IP Address Filter]

It displays information restricting users who can print and change settings.

- ↑ How to change settings
 - ❖ "Restricting the Users Who Can Print or Perform the Printer Settings"

(8) [MAC Address Filter]

It displays information restricting users who have access.

- ↑ How to change settings
 - "Restricting the Users Who Can Access"

(9) [Back to Page Top]

It moves the scroll box up to the top of the page.

NOTE

Changing the settings

You can only change settings when you are logged on in system manager mode.

[License/Other] Page/[Message Board/Support Link] Page

For LBP6680x

It displays the pages that the settings for message boards or support links, or registering or updating software are performed.

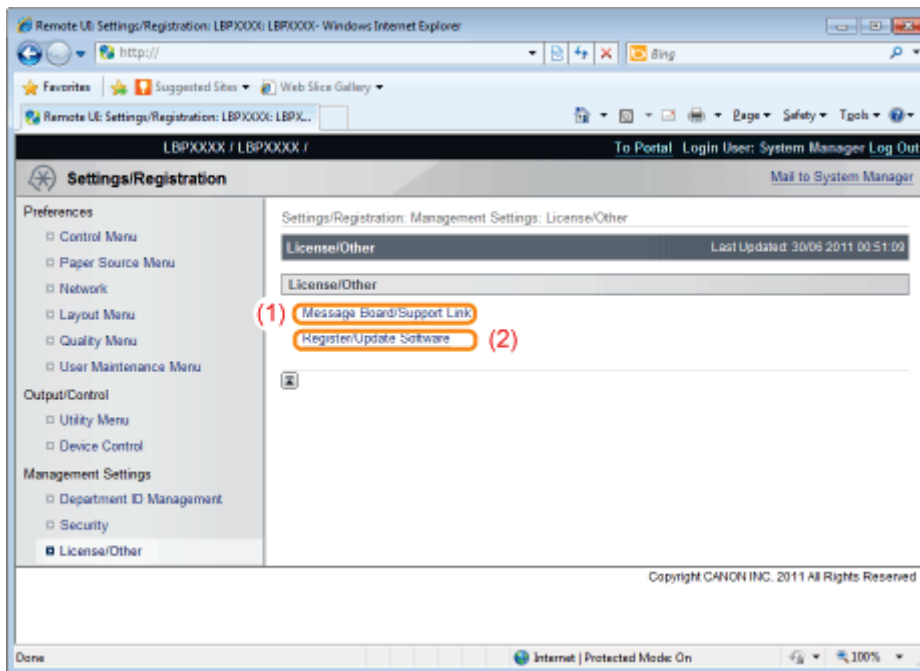

(1) [Message Board/Support Link]

It displays messages from the administrator and links to support pages.

- ↑ How to change settings
 - "Display/Change Message Board Messages and Support Links"

(2) [Register/Update Software]

It displays the pages that registering or updating software is performed.

- ↑ How to change settings
 - "Register/Update Software Function (LBP6680x Only)"

For LBP6670dn

It displays messages from the administrator and links to support pages.

See "Display/Change Message Board Messages and Support Links" for setting procedures.

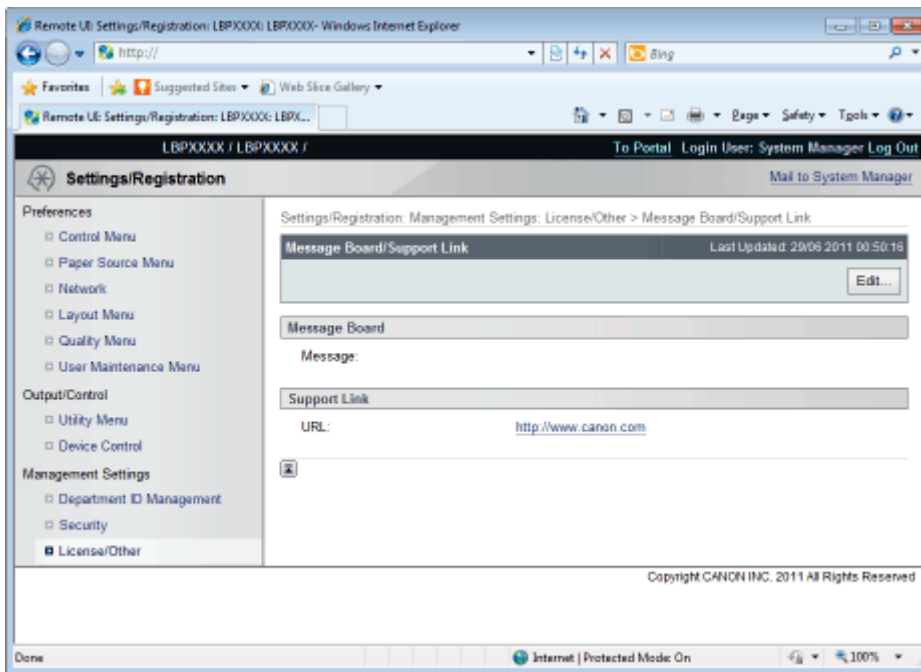

NOTE

Changing the settings

You can only change settings when you are logged on in system manager mode.

Display/Change Message Board Messages and Support Links

04L9-0A1

You can post messages from the administrator on a message board on the portal page of the Remote UI. Also, you can set links to information about printer support in the portal page support link, and make it accessible from the Remote UI when necessary.

When you are logged in system manager mode, you can change the messages on the message board and change the link destination of support links.

Displaying a Support Page

1

From [Support Link] on the portal page, click the link destination on the support page.

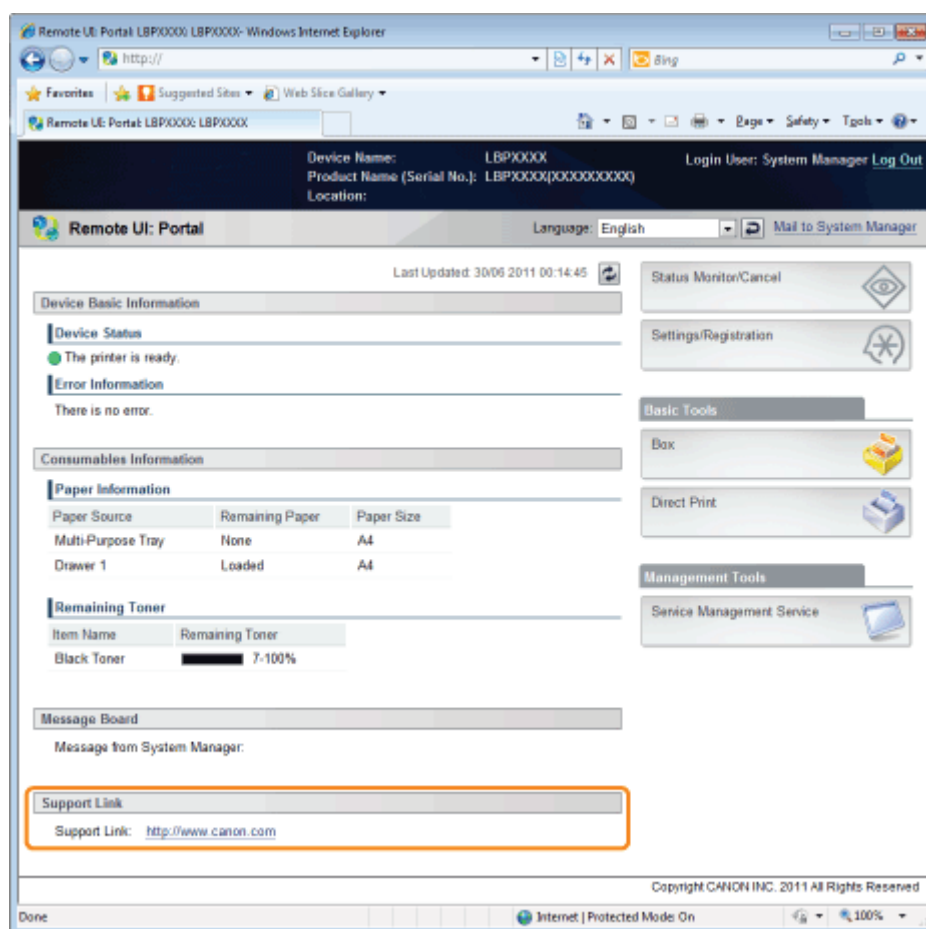

Changing Message Board Comments or Support Link Destinations

1

Select [Message Board/Support Link].

LBP6680x

From the [Settings/Registration] menu, select [Message Board/Support Link] in [License/Other] under [Management Settings].

LBP6670dn

Select [Message Board/Support Link] under [Management Settings] in the [Settings/Registration] menu.

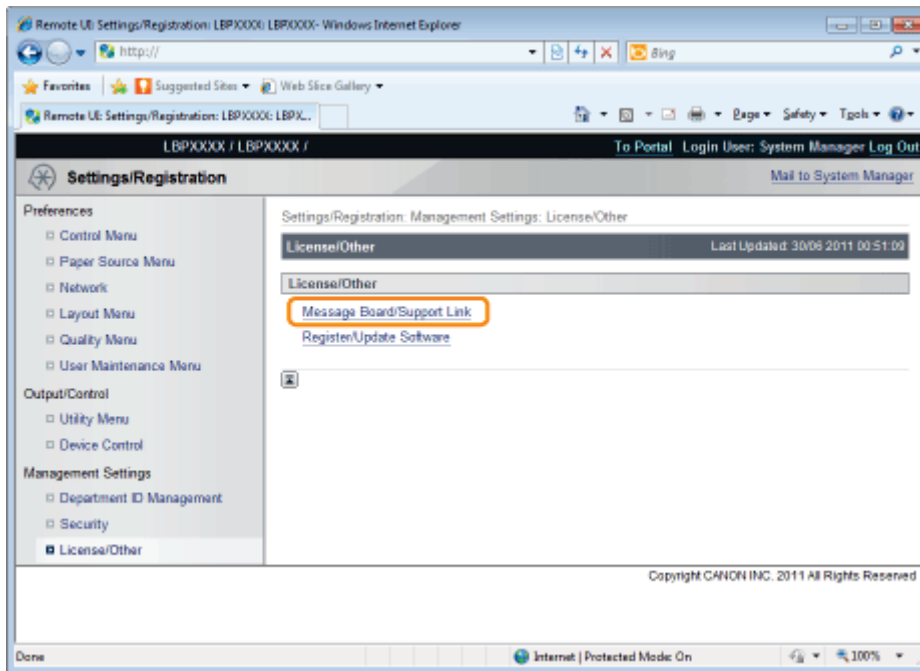

2

Click [Edit...].

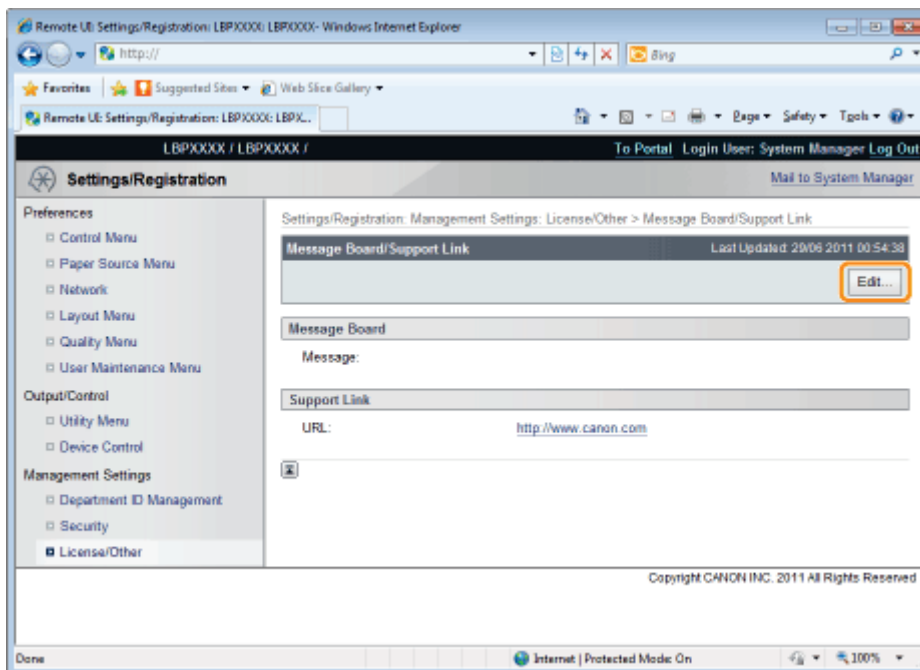

? If [Edit...] does not appear

Log in as Administrator.

➤ "Starting the Remote UI"

3

Change the message link destination.

- (1) Set message board messages when necessary.
- (2) Set support link URL when necessary.

(3) Click [OK].

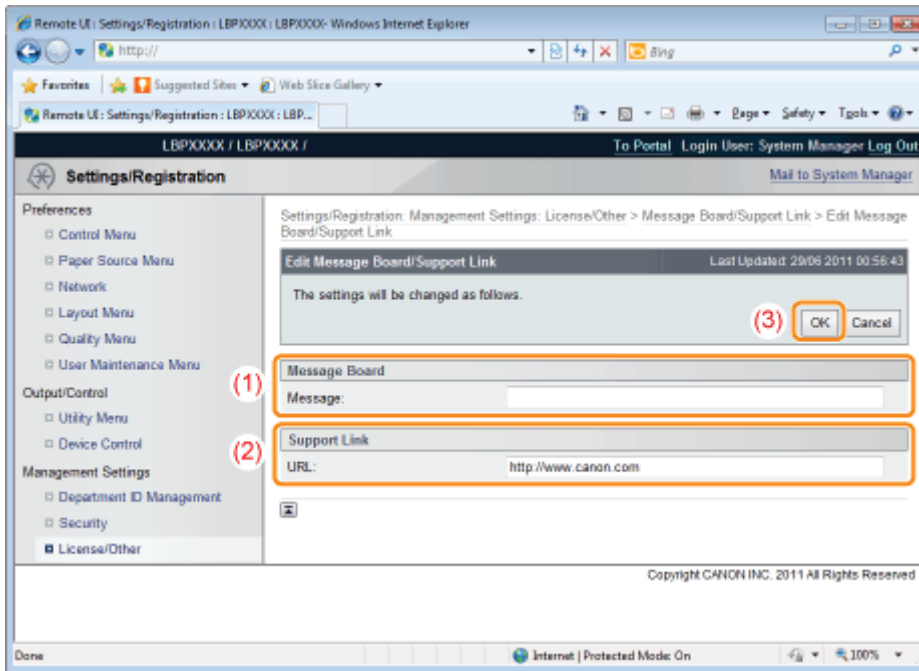

[Message]	Enter messages from the administrator.
[URL]	Enter the URL address of the support link.

In FTP Client, you can specify the network settings, security settings, and so on by accessing the FTP server of the printer using Command Prompt.

<Features of FTP Client>

- **No specific software is needed.**

You can operate the FTP Client using the Command Prompt supplied with Windows. You do not need specific software to operate the FTP Client.

- **You can specify the network settings at a time.**

Because the setting items are listed in a file, you can specify multiple items all at once.

To manage the printer using FTP Client, perform the following procedure.

IMPORTANT

If the [FTP Settings] check box is not selected in the [TCP/IP Settings] page in [Settings/Registration] - [Preferences] - [Network], settings cannot be specified from the FTP client.

➤ ["Configuring the Protocol Settings"](#)

NOTE

For Macintosh users

For details on the procedure for Macintosh, see "[FTP Client \(Macintosh\)](#)."

1

Run Command Prompt.

NOTE

If you are using Windows

Run Command Prompt using the following procedure.

- From the [Start] menu, select [All Programs] or [Programs] → [Accessories] → [Command Prompt].

If you are using UNIX

Display the console screen.

2

Enter "ftp <the IP address of the printer>", and then press the [ENTER] key on your keyboard.

- **Input Example:** "ftp 192.168.0.215"

If you are not sure about the IP address of the printer

Print and confirm Network Status Print while referring to "[Checking the Printer Settings](#)", or consult your network administrator.

3

Enter "root" as the user name, and then press the [ENTER] key on your keyboard.

4

Enter the administrator password, and then press the [ENTER] key on your keyboard.

† The default password is "7654321".

5

Enter "cd config", and then press the [ENTER] key on your keyboard.

6

Enter "get CONFIG <the file name>", and then press the [ENTER] key on your keyboard.

† Enter "CONFIG" as all upper case characters.

→ The config file is downloaded.
The characters entered for <the file name> become the name of the downloaded file.

? If you cannot find the config file

Search for the config file using the file search function of your operating system.
(The download directory for the config file varies depending on the operating system or settings.)

7

Edit the downloaded config file in Notepad or a similar text editor.

For details on descriptions of each option, see "[Network Setting Items.](#)"

8

Enter "put <the file name> CONFIG", and then press [ENTER] key on your keyboard.

† Enter "CONFIG" as all upper case characters.

→ The edited config file uploads.

In <the file name>, enter the name of the config file that was entered when the file was downloaded.

9

Enter "get reset", and then press the [ENTER] key on your keyboard.

→ When the printer is restarted the settings will be enabled.
After checking that the printer has restarted, press the [c] key while holding down the [Ctrl] key, and return to the ftp command prompt.

10

Enter "quit", and then press the [ENTER] key on your keyboard.

11

Enter "exit", and then press the [ENTER] key on your keyboard.

→ Command Prompt closes.

NetSpot Device Installer is the Canon software included in the supplied CD-ROM.

<Features of NetSpot Device Installer>

- **You do not need to install NetSpot Device Installer.**
You can start NetSpot Device Installer directly from the CD-ROM without installing it.
 - † You can also install NetSpot Device Installer on a computer.
- **You can check the various printer statuses.**
You can view the list of statuses of the Canon devices on a network easily.
Also, you can change the default network settings or basic protocol settings.

For details on other procedures for starting and using NetSpot Device Installer, see the following.

- Starting method: "Printer Driver Installation Guide"
 - † For details on the procedure for viewing "Printer Driver Installation Guide", see "[Installation](#)."
- Usage: Help of NetSpot Device Installer
 - † Help is displayed by clicking [Help] in the [Help] menu.

IMPORTANT

If Windows Firewall is enabled

Before starting NetSpot Device Installer, configure Windows Firewall to unblock NetSpot Device Installer.
For details on the configuration procedure, see the Readme file of NetSpot Device Installer.

About operating systems that NetSpot Device Installer supports

For details on the latest NetSpot Device Installer, see the Canon Web site (<http://www.canon.com/>).

Managing Print Jobs

04L9-0A4

You can check/delete the job currently being printed or check job histories using the Remote UI.

- † You can also delete the job currently being printed using a method other than the Remote UI.
 - ✦ "Canceling a Job"

Before managing print jobs, see "Attention (Job Manager)."

Checking/Deleting the Job Currently Being Printed

1

Start the Remote UI.

- ✦ "Starting the Remote UI"

2

From the [Status Monitor/Cancel] menu, select [Job Status] to display the job currently being printed.

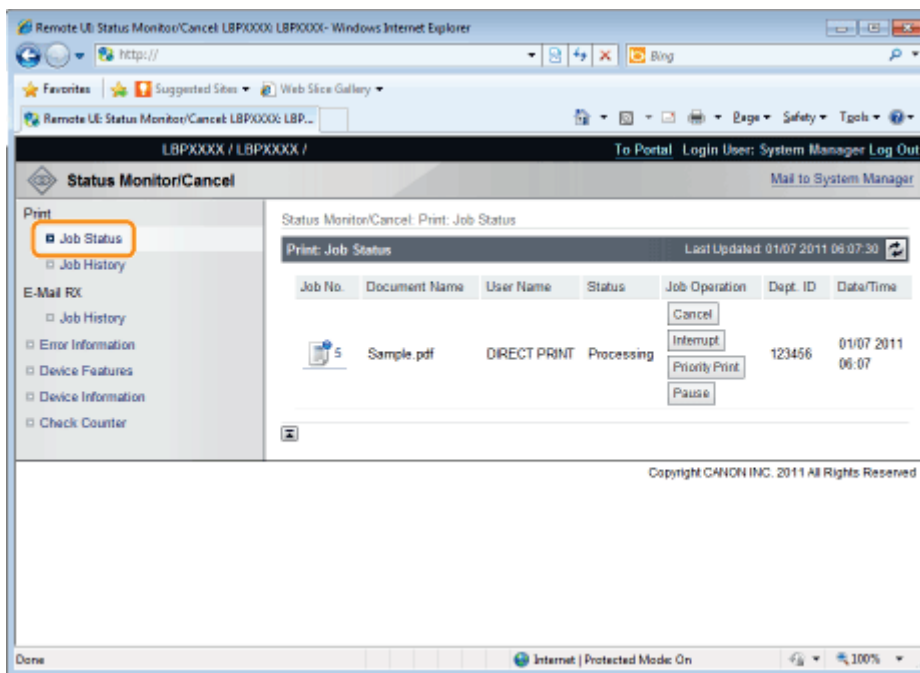

3

If you want to delete the job, perform the following procedure.

Using job operation, click [Cancel] on the job you want to delete.

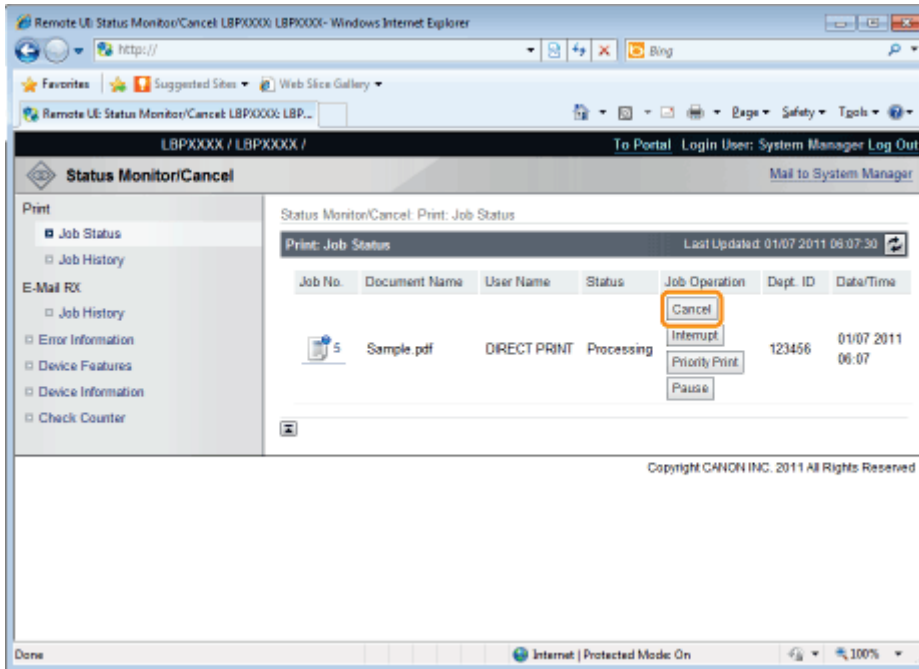

Checking Job History

1

Start the Remote UI.

- "Starting the Remote UI"

2

Select [Job History] from the [Status Monitor/Cancel] menu.

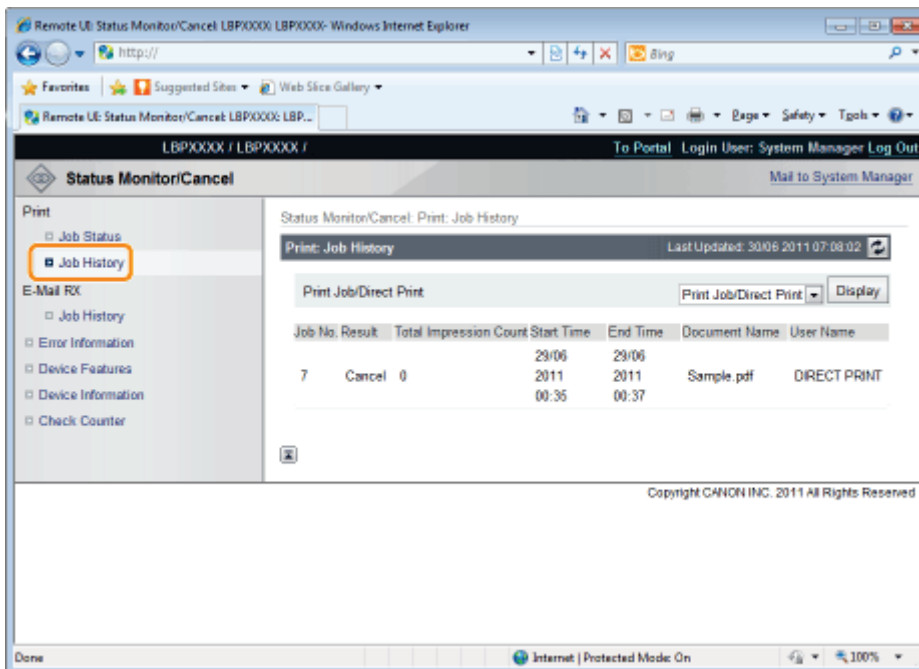

3

Select the options that you want to display.

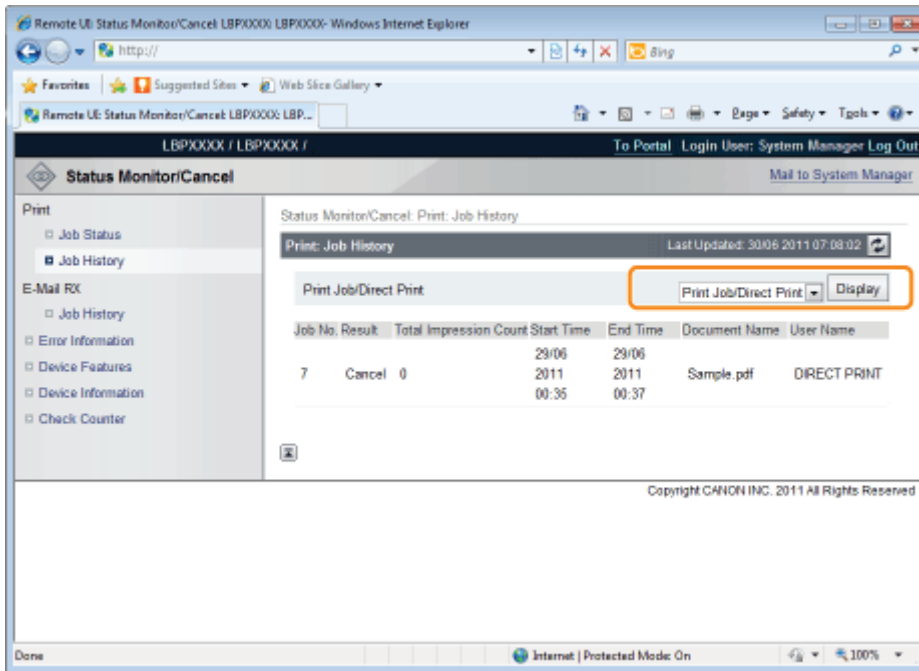

[Print Job/Direct Print]: The printed job history is displayed from the computer.

[Stored Job]: The printing history of jobs stored in BOX is displayed. (LBP6680x only)

[Report]: The utility print printing history is displayed.

[E-Mail Print]: The history of jobs received by e-mail and printed is displayed.

IMPORTANT

Deleting the print logs

The print logs are deleted by turning the printer OFF or performing a hard reset.

NOTE

About [Document Name]

A job file name of up to 32 characters can be displayed. If the file name has more than 32 characters, the characters after the limited number are not displayed.

Also, depending on the application, the application name may be added to the beginning of the file name.

About the job histories

- The maximum numbers of the print logs that you can check are as follows. When the number of the jobs exceeds the maximum, the job histories are deleted starting from the oldest one.

LBP6680x

- [Print Job/Direct Print]: 200
- [Stored Job]: 128
- [Report]: 128
- [E-Mail Print]: 128

LBP6670dn

- [Print Job/Direct Print]: 48
- [Report]: 16
- [E-Mail Print]: 128
- If the job log display is not specified in [Display Job History] in the [Settings/Registration] - [Management Settings] - [Security] page, you cannot display the job histories.
 - ["Specifying the Setting for Job Log Display"](#)

Control Panel Setting



04L9-0A6

This section describes the menu operation for this printer.

Procedure for the Menu Operation

The menu consists of three hierarchies: "Option", "Item", and "Setting Value." Select the target options in each hierarchy. As an example of the setting procedure, this section describes the procedure for setting [Drawer 1 Size] in the [Paper Source] to [B5]. Start the key operation from Step 1.

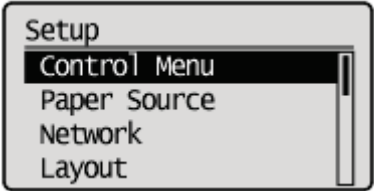
Before specifying the setting, see "Attention (Control Panel Setting)."

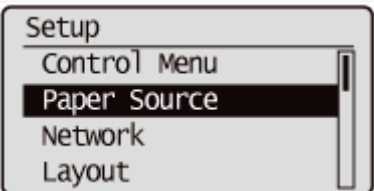
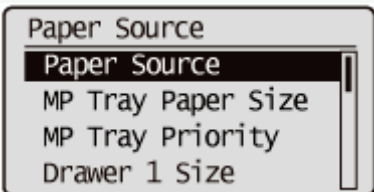
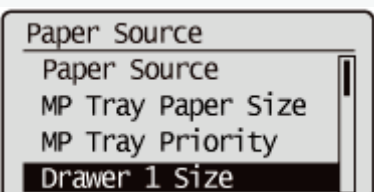
	Operation Procedure	Key Operation
1	Place the printer offline.	Press [] (↔ : Online). When the printer is online, the [Setup] menu can be displayed, however, the [User Maintenance] options cannot be specified.
2	Display the [Setup] menu. 	Press [] (☑ : Settings). The [Setup] menu is displayed.
3	Select the option. When the [Paper Source] options are selected 	Press [▲] or [▼]. The target option is displayed.
4	Display the item. 	Press [OK]. The selected item is displayed.
5	Select the item. When [Drawer 1 Size] is selected 	Press [▲] or [▼]. The target item is displayed.
		Press [OK].

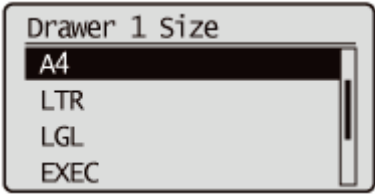
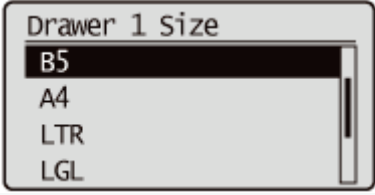
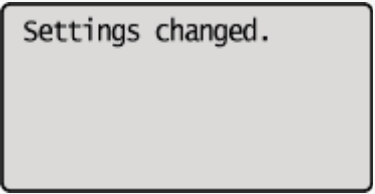
6	Select the item. 	The selected setting value is displayed.
7	Select the setting value. When [B5] is selected 	Press [▲] or [▼]. The target setting value is displayed.
8	Determine the selected setting value. 	Press [OK]. The target setting value is specified. The setting completion screen is displayed for 3 seconds. You can change the display time for the screen using [Set. Comp. Notify] in the [Setup] menu.
9	Go out of the setting menu.	Press [⏪] (← : Online).

Printer Status to Enter the Menu Operation

You can enter each menu when the printer is in the following status.

○ : You can enter the menu

— : You cannot enter the menu

	When the printer is ready to print *1		When an error is occurring *2
	When the printer is online	When the printer is offline	
[Setup] Menu	○ *3	○	○
[Select Feeder] Menu	○	○	○
[Reset] Menu	○	○	○ *4
[Job] Menu	○	—	—
[Utility Menu] Menu	○	—	—

*1 The printer is ready to print when the ○ (Ready) indicator is on.

*2 An error is occurring in the printer when the ▲ (Message) indicator is on.

*3 The [User Maintenance] options cannot be specified.

*4 You cannot perform [Form Feed].

NOTE

If you want to go back up the previous hierarchy or cancel a selected item

- To go back up the previous hierarchy or cancel a selected item, press [●] (⤴ : Back) or [◀].
- Pressing [○] (⏪ : Online) on the screen during the menu operation cancels a selected item and places the printer online or offline.

When the printer can be placed offline

The printer can switch back to the offline state when it is ready to print (when the ○ (Ready) indicator is on).

About setting values

Depending on the item, some settings become effective after restarting the printer.

Setting priority

For details on the setting priority for when specifying the same item using a method other than the control panel as that specified using the control panel, see "[Setting Priority \(When Specifying the Same Item Using Multiple Methods\)](#)."

About items displayed in the display

Some items are added and displayed only when an optional accessory is installed, and you can select such items.

About the exclusive [Setup] menu

When the exclusive [Setup] menu is selected in the "Option" hierarchy, see the following about each option.

- PCL: ❖ "[Setup] Menu ([PCL] Options)"
- UFR II: ❖ "[Setup] Menu ([UFR II] Options)"
- Imaging: ❖ "[Setup] Menu ([Imaging] Options)"
- XPS: ❖ "[Setup] Menu ([XPS] Options) (LBP6680x Only)"
- PS: ❖ "[Setup] Menu ([PS] Options)"
- PDF: ❖ "[Setup] Menu ([PDF] Options)"

About [Initialize Menu]

[Initialize Menu] does not have a lower hierarchy than "Option."

For details on the procedure for the initialization, see "[Initializing the \[Setup\] Menu Using the Printer's Control Panel](#)."

➤ [Setup] Menu

- [Setup] Menu ([Control Menu] Options)
- [Setup] Menu ([Paper Source] Options)
- [Setup] Menu ([Network] Options)
- [Setup] Menu ([Layout] Options)
- [Setup] Menu ([Quality] Options)
- [Setup] Menu ([Interface] Options)
- [Setup] Menu ([User Maintenance] Options)
- [Setup] Menu ([Print Mode] Options)
- [Setup] Menu ([UFR II] Options)
- [Setup] Menu ([PCL] Options)
- [Setup] Menu ([Imaging] Options)
- [Setup] Menu ([XPS] Options) (LBP6680x Only)
- [Setup] Menu ([PDF] Options)
- [Setup] Menu ([PS] Options)
- [Setup] Menu ([MEAP Settings] Options) (LBP6680x Only)
- [Setup] Menu ([Check Counter] Options)

➤ [Utility Menu] Menu

➤ [Job] Menu

➤ [Reset] Menu

➤ [Select Feeder] Menu

[Setup] Menu ([Control Menu] Options)

04L9-0A9

NOTE

Table description

- Bold values in the table indicate the default settings.
- After changing the setting items with "**1", cycle the power of the printer or perform a hard reset to make the settings effective.
- The setting items or setting values with "**2" may not be displayed depending on the availability of the optional accessories and other settings.

Setting Item	Setting Value	Setting
[Sleep Mode]	[High (Deep Sleep)]	Set the sleep mode. ➤ "Sleep Mode"
[Sleep Even if Error]	[Off], [On]	
[Sleep Migration Time]	[5 minutes] , [10 minutes], [15 minutes], [30 minutes], [60 minutes]	
[Timer Settings]		
[Wake Up Timer]	[Off] , [On]	Set sleep mode (deep sleep mode) to cancel automatically. ➤ "Sleep Mode"
[Wake Up Time]	00:00 to 12:00 to 23:59	
[Auto Reset Time]	[Off], [10 seconds], [20 seconds], [30 seconds], [40 seconds], [50 seconds], [1 minute], [2 minutes] , [3 minutes], [4 minutes], [5 minutes], [6 minutes], [7 minutes], [8 minutes], [9 minutes]	Specifies whether one of the following transitions is to take place when no key operation has been performed in a particular screen. <ul style="list-style-type: none"> • A transition to the MEAP authentication screen (LBP6680x only) • A transition to the ready status screen and the screen for using MEAP applications (LBP6680x only) • A transition from offline status to online status <p>† When no key operation has been performed during a job processing session, this function is also executed depending on the current screen or current position in a menu.</p> <p>➤ "Online and Offline"</p>
[Sleep Mode Timer]	[Off] , [On]	Specifies whether the sleep timer function is used to put the printer into a sleep mode (deep sleep mode) when the printer is not used for a certain time. ➤ "Sleep Mode"
[Sleep Mode Time]	00:00 to 12:00 to 23:59	
[Warning Step]		
[Toner Cart. Warning]	[Continue Printing] , [Stop Printing]	Specifies whether the printer should continue or stop printing when <Toner cartridge will soon reach end of lifetime> appears.
[Auto Continue]	[Off] , [On]	Specifies whether the printer should automatically use the function that, when an error is occurring, releases the printer from the error temporarily (Error Skip) and

		continues the job.
[Panel Language]	[Čeština], [Dansk], [Deutsch], [English] , [Español], [Français], [Italiano], [Magyar], [Nederlands], [Norsk], [Polski], [Português], [Русский], [Suomi], [Svenska], [Türkçe], [中文(简体)], [한국어]	Specifies the language to be displayed in the display. † This setting allows you to change language displayed in the Remote UI login screen. (LBP6680x only)
[Alarm]	[Off], [On]	Specifies an alarm sound for when an error occurs.
[Show Warnings]		
[Toner Cart. Warning]	[Off], [On]	Specifies whether the printer should display <16 Tnr cart. will soon reach end of lifetime.> when the toner cartridge needs to be replaced soon.
[Drawer Empty]	[Off], [On]	Specifies whether the printer should blink the Paper Source indicator for the paper drawer that ran out of paper.
[E-Mail Trans. Error]	[Off], [On]	Specifies whether the printer should display an error message when a communication error occurs in the e-mail printing.
[Date/Time Settings]		
[Date]	01/01 2001 to 31/12 2030	Specify date or time when the clock is not keeping correct date or time. ❖ "Turning the Power On and Specifying a Language"
[Time (24 hour)]	00:00:00 to 23:59:59	
[Daylight Savings] ^{*1}		
[DST Settings]	[Off] , [On]	Specifies whether to set the daylight saving time.
[Start Date/Time]/[End Date/Time]	[Month] , [Week], [Day], [Time]	Specifies the time duration of the daylight saving time.
[Time Zone] ^{*1}	GMT-12:00 to GMT+12:00	Specifies the time zone according to the region where the printer is being used.
[SD Card] ^{*1*2}	[Off], [On]	Specify whether to use SD cards. When the optional SD card is installed, you will be able to use the following functions. <ul style="list-style-type: none"> • Interrupt print • Changing the order of print data (Priority print) • Pausing/Resuming print data processing (Pausing/Resuming printing) • Saving print data on the SD card (boxes) (Stored job print) • Spooler • SMB print Importing and Exporting Settings <ul style="list-style-type: none"> • Stored Job List • Print History List (Stored Job)
[Interrupt Print] ^{*2}	[Off], [On]	Set whether to allow the job printing to be interrupted. ❖ "Giving Priority to a Print Job (Interrupt Printing) (LBP6680x Only)"

[Sec. Print Del. Time]*1 *2	[1 hour] , [2 hours], [3 hours], [6 hours], [12 hours], [24 hours]	Set the amount of time before secure print jobs are automatically deleted. <ul style="list-style-type: none"> • "Specifying a Password for a Document and Printing (Secured Print) (LBP6680x Only)"
[Secure Job Log]	[Off] , [On]	If [On] is specified for this item, the print log of the job being printed is saved, and the total number of printed pages (page counter) is counted even when you turn the printer OFF.
[Select PDL (PnP)]*1*2	[UFR II] , [UFR II XPS], [PCL5e], [PCL6], [PS3]*2, [XPS (Direct)]*2	<ul style="list-style-type: none"> • If you want to connect the printer and computer with a USB cable The printer driver for this printer may be installed automatically when the USB cable is connected. You can select the type of the printer driver ("UFR II", "UFR II XPS", "PCL5e", "PCL6", "PS3", or "XPS (Direct)") to be installed in this item at the time. • If you want to connect the printer and computer with a LAN cable If you are using Windows Vista, you can detect the printer automatically using the WSD (Web Service on Devices) protocol. You can select the type of the printer driver ("UFR II", "UFR II XPS", "PCL5e", "PCL6", "PS3", or "XPS (Direct)") to be installed on the automatically detected printer in this item.
[Mng. Settings]		
[Settings Key Lock]	[Off] , [On]	<ul style="list-style-type: none"> • When you set to [On], [] (<input checked="" type="checkbox"/> : Settings) is locked and you cannot operate the Setup menu. • When you set to [Off], [Settings Key Lock] is not locked. <p>* You can unlock the locked Settings key only from the Remote UI.</p>
[Adjust Screen]		
[Contrast]	(-3 Dark - 0 - +3 Light)	If the display is not clear, adjust the contrast or brightness to the desired level.
[Backlight Brightness]	[Off], [Level 1], [Level 2], [Level 3]	
[Animated Instruction]	[Off], [On]	Specifies whether the printer should display an animated picture in the display when a paper jam occurs or when a toner cartridge is replaced.
[Show Toner Gauge]	[Off], [On]	Specifies whether the printer should display the icon that indicates the toner remaining.
[Set. Comp. Notify]	[Off], [1 second], [2 seconds], [3 seconds]	Specifies the display time of messages that are displayed when the setting completes. If [Off] is specified, no setting completion message is displayed.
Set the scrolling speed for the message		

[Scrolling Speed]

[Slow], **[Normal]**, [Fast]

display on the control panel.

[Setup] Menu ([Paper Source] Options)

04L9-0AA

NOTE

Table description

- Bold values in the table indicate the default settings.
- The setting items or setting values with "*" may not be displayed depending on the availability of the optional accessories and other settings.

About the icons

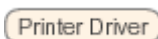
 Printer Driver

The settings for the printer driver are prioritized for this item.

:

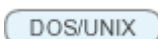
 DOS/UNIX

When you are printing from DOS, UNIX, or other operating systems which do not use the printer driver, the settings are enabled for this item.

:

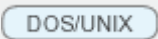
Setting Item	Setting Value	Setting
[Paper Source]	[Auto] , [Drawer 1], [Drawer 2]*, [Multi-Purpose Tray]	Select the default paper source that is used when printing.
[MP Tray Paper Size]	[A6], [A5], [B5], [A4] , [LTR], [LGL], [EXEC], [Mixed Sizes], [Custom Size], [Custom Size R], [Env. ISO-C5], [Env. Monarch], [Env. No.10], [Env. DL], [Env. ISO-B5], [Index Card], [STMT], [16K]	Specifies the size of the paper loaded in the multi-purpose tray. ❖ "Registering the Paper Size"
[MP Tray Priority]	[Off] , [On]	Specifies whether the printer should detect the paper source in order starting with the multi-purpose tray when [Paper Source] is set to [Auto] in "[Select Feeder] Menu."
[Drawer 1 Size]/[Drawer 2 Size]*	[A6], [A5], [B5], [A4] , [LTR], [LGL], [EXEC], [Mixed Sizes], [Custom Size], [Custom Size R], [16K]	Specifies the size of the paper loaded in the paper drawer. ❖ "Registering the Paper Size"
[Standard Paper Size] 	[A6], [A5], [B5], [A4] , [LTR], [LGL], [EXEC], [Env. ISO-C5], [Env. Monarch], [Env. No.10], [Env. DL], [Env. ISO-B5], [Index Card], [STMT], [16K]	If you cannot specify the paper size or if you print from DOS, UNIX, or other operating system, specify the paper size in this item. ❖ "Loading Paper in the Paper Drawer" ❖ "Loading Paper in the Multi-purpose Tray"
[Diff. Paper Tray]	[Off] , [On]	Specifies whether the printer should feed paper from the multi-purpose tray when paper of the size for the received data is not loaded in the paper drawer.
[Auto Selection]	<ul style="list-style-type: none"> • [Multi-Purpose Tray]: [Off], [On] • [Drawer 1]: [Off], [On] • [Drawer 2]*: [Off], [On] 	Specifies the paper source to be automatically selected when [Paper Source] is set to [Auto] in "[Select Feeder] Menu." If [On] is specified, the printer selects the paper source as the one to be automatically selected.
[Default Paper Type]	[Plain] , [Plain L], [Heavy 1], [Heavy 2], [Transparency], [Envelope], [Labels]	If you cannot specify the paper type or if you print from DOS, UNIX, or other operating system, specify the paper type

DOS/UNIX		in this item.
[2-Sided Printing] Printer Driver	[Off] , [On]	Specifies whether the printer should print on one side or both sides of the paper.

[Setup] Menu ([Network] Options)

04L9-0AC

NOTE

Table description

- After changing the settings for this item, cycle the power of the printer or perform a hard reset to make the settings effective.
- This item is displayed only when all the following conditions are met.
 - [Network] in [Interface Selection] is set to [On].
- Bold values in the table indicate the default settings.
- The setting items or setting values with "*" may not be displayed depending on the availability of the optional accessories and other settings.

Setting Item	Setting Value	Setting
[TCP/IP Settings]		Specifies the TCP/IP setting for the print server equipped with this printer.
[IPv4 Settings]	[IPv4]: [Off], [On]	When using IPv4, set it to [On].
	[IP Mode]: [Auto], [Manual]	Select the method for setting the IP address. <ul style="list-style-type: none"> • When setting the IP address using any one of DHCP, BOOTP, or RARP, select [Auto]. • When specifying the IP address to the printer directly, select [Manual].
	[Protocol]*: <ul style="list-style-type: none"> • [Use DHCP]: [Off], [On] • [Use BOOTP]: [Off], [On] • [Use RARP]: [Off], [On] 	If you set [IP Mode] to [Auto], select which protocol you want to use. Set each of [Use DHCP], [Use BOOTP], and [Use RARP] to [On] (use) or [Off] (do not use).
	[IP Address Settings]: <ul style="list-style-type: none"> • [IP Address]: 0.0.0.0 • [Subnet Mask]: 0.0.0.0 • [Gateway Address]: 0.0.0.0 	Specify [IP Address], [Subnet Mask], and [Gateway Address]. For the method for entering the addresses, see " Method for entering addresses " below the table.
	[DNS]: <ul style="list-style-type: none"> • [Primary Address]: 0.0.0.0 • [Secondary Address]: 0.0.0.0 	Specify [Primary Address] and [Secondary Address] for DNS. For the method for entering the addresses, see " Method for entering addresses " below the table. * Specify the settings for [Host Name], [Domain Name], and [DNS Dynamic Update] from the Remote UI. <ul style="list-style-type: none"> ➤ "Configuring the Protocol Settings"
	[DHCP Option]: <ul style="list-style-type: none"> • [Acquire Host Name]: [Off], [On] • [DNS Dynamic Update]: [Off], [On] 	Set DHCP options when [IP Mode] is set to [Manual] and [Use DHCP] is set to [On]. <ul style="list-style-type: none"> • When obtaining the host name using DHCP, set [Acquire Host Name] to [On]. • When updating the host name using DHCP, set [DNS Dynamic Update] to [On].
		If you want to use IP v. 6, specify [On].

[IPv6 Settings]	[IPv6]: [Off] , [On]	* Specify the setting for IP v. 6 from the Remote UI. <ul style="list-style-type: none"> ➤ "Setting IP v. 6"
[WINS Resolution]	[Off] , [On]	If you want to use WINS Resolution, specify [On]. * Specify the following settings from the Remote UI. <ul style="list-style-type: none"> • [WINS Server Address] • [Scope ID] • [SMB Server Name] • [SMB Workgroup Name] <ul style="list-style-type: none"> ➤ "Configuring the Protocol Settings"
[ARP/PING]	[Off], [On]	When it is set to [On], you can change the IP address settings from the client using ARP/PING commands.
[FTP]	<ul style="list-style-type: none"> • [FTP Print]: [Off], [On] • [FTP Settings]: [Off], [On] 	When it is set to [On], you can access the printer's FTP server using the FTP client and print the files. If you want to perform the settings using FTP Client, set [FTP Settings] to [On]. * Specify the settings for [FTP Print User Name] and [Password] from the Remote UI. <ul style="list-style-type: none"> ➤ "Configuring the Protocol Settings"
[LPD Print]	[Off], [On]	If you want to use LPD Print, specify [On]. * Specify the setting for [Print LPD Banner Page] from the Remote UI. <ul style="list-style-type: none"> ➤ "Configuring the Protocol Settings"
[RAW Print]	[Off], [On]	If you want to use RAW Print, specify [On]. * Specify the setting for [Use Bidirectional Communication] from the Remote UI. <ul style="list-style-type: none"> ➤ "Configuring the Protocol Settings"
[IPP Print]	[Off] , [On]	If you want to use IPP Print, specify [On]. * Specify the settings for [IPP Authentication], [User Name], and [Password] from the Remote UI. <ul style="list-style-type: none"> ➤ "Configuring the Protocol Settings"
[WSD]	<ul style="list-style-type: none"> • [WSD Print]: [Off], [On] • [WSD Browsing]*: [Off], [On] • [Multicast Discovery]: [Off], [On] 	If you want to use WSD Print, set [WSD Print] to [On], and then specify the following settings. <ul style="list-style-type: none"> • If you want to obtain printer information using WSD, set [WSD Browsing] to [On]. If you set [WSD Print] to [On], [WSD Browsing] is not displayed. ([WSD Browsing] is fixed at [On].) • If you want to set the printer to respond to requests from multicast discovery, set [Multicast Discovery] to [On].
[HTTP]	[Off], [On]	<ul style="list-style-type: none"> • When it is set to [On], you will be able to access the printer using HTTP. • When this is set to [Off], the message appears, disallowing you to use the Remote UI or perform IPP printing.
	[Proxy]: [Off] , [On]	If you want to use the proxy function, specify [On].
	[Server Address]*: -	Enter the proxy server address to be used for the proxy function.
	[Port Number]*: 0 to 80 to 99999	Enter the port number of the proxy server to be used for the proxy function. You can specify between [0] and [99999].

[Proxy Settings]*	[Same Domain]*: [Use Proxy], [Do Not Use Proxy]	If you want to use the proxy function also for the same domain, specify [Use Proxy].
	[Proxy Authentication]*: [Off] , [On]	If you want to use the proxy authentication function, specify [On].
	[User Name]*: -	Enter the user name to be used for the proxy authentication. Up to 24 alphanumeric characters can be entered.
	[Password]*: -	Enter the password to be used for the proxy authentication. Up to 24 alphanumeric characters can be entered.
[SNTP]	[Off] , [On]	When obtaining time using the SNTP Client function, specify [On]. * Specify the settings for [NTP Server Name] and [Polling Interval] from the Remote UI. ➤ "Configuring the Protocol Settings"
[Discovery Response]	[Off], [On]	If you want to set the printer so that it responds to searches that used the multicast discovery function, specify [On]. * Specify the setting for [Scope Name] from the Remote UI. ➤ "Configuring the Protocol Settings"
[IPSec]	[Off] , [On]	When using the IPSec function, set it to [On]. ➤ "Setting the IPSec Encryption Communication Function (LBP6680x Only)"
[NetWare Settings]	<ul style="list-style-type: none"> • [NetWare]: [Off], [On] • [Frame Type]*: [Auto Detect], [Ethernet II], [Ethernet 802.2], [Ethernet 802.3], [Ethernet SNAP] • [Print Service]*: [Bindery PServer], [RPrinter], [NDS PServer], [NPrinter] 	Configures the NetWare network settings. ➤ "Configuring the Protocol Settings"
[AppleTalk]	[Off] , [On]	Specifies whether the printer should use AppleTalk. ➤ "Configuring the Protocol Settings"
[SMB]*	[SMB Server]: [Off] , [On] [SMB Print]: [Off] , [On]	Specifies whether the printer should use SMB. ➤ "Network Settings for the Printer (SMB) (LBP6680x Only)"
[SNMP Settings]		Specify the settings related to SNMP protocol. ➤ "Restricting the Users Who Can Monitor/Change the Settings Using the SNMP Protocol"
[SNMP v. 1 Settings]		Specify the settings related to SNMP v. 1 protocol.
[SNMP v. 1]	[Off], [On]	Specify whether to use the SNMP v. 1 protocol.
[Dctd. Community Set.]	<ul style="list-style-type: none"> • [Dctd. Community 1]: [Off], [Read/Write], [Read Only] • [Dctd. Community 2]: 	<ul style="list-style-type: none"> • [Dctd. Community 1] Specifies access privileges for the Management Information Base (MIB) of the community (canon_admin) that SNMP manages. • [Dctd. Community 2] Specifies access privileges for the Management Information

	[Off], [Read/Write] , [Read Only]	Base (MIB) of the community (canon_user) that SNMP manages.
[SNMP v. 3 Settings]	[SNMP v. 3]: [Off] , [On] [User Settings 1] to [User Settings 5]*: <ul style="list-style-type: none"> [Auth. Password] [Encryption Password] 	Specify the settings related to SNMP v. 3 protocol.
[R]ject Packet in Sleep]	[Off] , [On]	Specifies whether to discard the SNMP packets received while in sleep mode. † If you set this item to [On], you may be unable to access the printer from Canon software (iW Series) or applications using the SNMP protocol.
[Spooler]*	[Off] , [On]	When using the spooling function, set it to [On]. ✦ "Setting the Spooling Function (LBP6680x Only)"
[Network Delay Time]	0 to 300 seconds	Specifies the time interval from when the printer is turned ON to when the protocol starts. ✦ "Specifying the Setting for Startup Waiting Time"
[Remote UI Settings]	<ul style="list-style-type: none"> [Remote UI]: [Off], [On] [SSL]*: [Off], [On]* 	Specifies whether the printer should use the Remote UI. Also, whether to use SSL for communication by the Remote UI is specified. ✦ "Setting Keys and Certificates"
[Ethernet Driver]	<ul style="list-style-type: none"> [Auto Detect]: [Off], [On] [Communication Mode]*: [Half Duplex], [Full Duplex] [Ethernet Type]*: [10 Base-T], [100 Base-TX], [1000 Base-T] 	Configures the Ethernet driver. ✦ "Changing the Network Transmission Speed or Transfer Mode"
[IEEE802.1X]	[Off] , [On]	When using the IEEE802.1X function, set it to [On]. ✦ "Setting IEEE802.1X Authentication"
[Address Filter]	[Off] , [On]	When using the address filter function, set it to [On]. ✦ "Restricting the Users Who Can Print or Perform the Printer Settings" ✦ "Restricting the Users Who Can Access"
[MAC Address]	(Display only)	Displays the MAC address of the printer.
[E-Mail Print Set.]	[POP3 RX Interval]: 0 to 90 (minutes) [POP3 RX]: [Off] , [On] [SMTP RX]: [Off] , [On]	Set e-mail print. † When [POP3 RX Interval] is changed from 0 minute, POP3 reception immediately after the setting has been changed is performed at a specified interval plus approximately five seconds. From the second time onwards, POP3 reception is performed at a specified interval. ✦ "Receiving E-mail Data on the Mail Server and Printing (E-mail Print)"
[Init. Network Set.]	—	By the initialization in this item, you can reset the network settings to the default settings. ✦ "Initializing the Network Settings"

Method for entering addresses

1. Move the cursor to each field (an area separated by periods to enter three-digit numbers) in which you want to enter the address, by pressing [◀] or [▶]. (The number in the field blinks, allowing you to enter a value.)
 2. Enter the numbers. ([▲] increases the value and [▼] decreases the value.)
 3. After entering values in all the fields, press [OK] to confirm the settings.
-

[Setup] Menu ([Layout] Options)



NOTE

Table description

Bold values in the table indicate the default settings.

About the icon

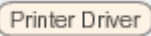
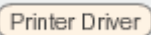
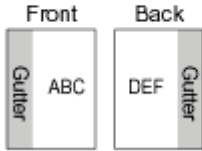
 : The settings for the printer driver are prioritized for this item.

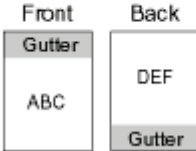
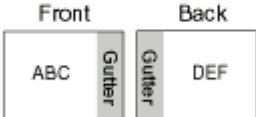
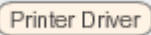
Setting Item	Setting Value	Setting
[Copies] 	1 to 9999	Specifies the number of copies to be printed. The printer prints the specified number of copies.
[Offset Y]/[Offset X]	-50.0 to 0.0 to +50.0 (mm)	Adjusts the printing position in the vertical direction (Y) or the horizontal direction (X) by the specified value. "Adjusting the Printing Position for All the Jobs"
[Binding Location] 	[Long Edge] , [Short Edge]	<p>Specifies which edge of the paper, the long edge or short edge, is to be bound. When performing 2-sided printing, the printer adjusts the binding location automatically according to the paper surface.</p> <ul style="list-style-type: none"> If [Long Edge] is specified, the binding location is created on the long edge of the paper. <div style="display: flex; justify-content: space-around; margin-top: 10px;"> <div style="text-align: center;"> <p>When loading paper in portrait orientation and performing 2-sided printing</p>  </div> <div style="text-align: center;"> <p>When loading paper in landscape orientation and performing 2-sided printing</p>  </div> </div> If [Short Edge] is specified, the binding location is created on the short edge of the paper. <div style="display: flex; justify-content: space-around; margin-top: 10px;"> <div style="text-align: center;"> <p>When loading paper in portrait orientation and performing 2-sided printing</p>  </div> <div style="text-align: center;"> <p>When loading paper in landscape orientation and performing 2-sided printing</p>  </div> </div>
[Gutter] 	-50.0 to 0.0 to +50.0 (mm)	Specifies the gutter width for printing with the binding location created. A gutter is created with the image shifted by the specified value. You can shift the image in the "+" direction with a positive value and in the "-" direction with a negative value.

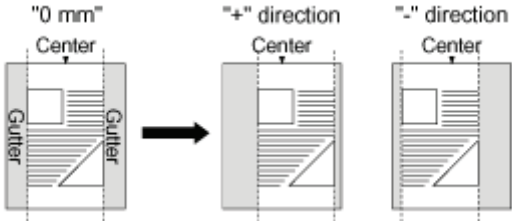
		 <p>The diagram illustrates three stages of printing alignment. The first stage, labeled '"0 mm" Center', shows a page with a central vertical line and two vertical dashed lines labeled 'Gutter' on either side. An arrow points to the second stage, '"+" direction' Center', where the page is shifted to the right. A third stage, '"-" direction' Center', shows the page shifted to the left. Each stage has a 'Center' label with a downward arrow pointing to the central vertical line.</p>
[Alternative Method]	[Off], [On]	<p>If this item is set to [On] and if the last page for the 2-sided printing is 1-sided printing, 1-sided printing is applied to the last page. (Printing can be performed faster than normal 2-sided printing.)</p> <p>However, when performing 2-sided printing on punched paper or previously printed paper, the orientation or printing surface of the last page may differ from other pages. In this case, specify [Off].</p>

[Setup] Menu ([Quality] Options)

04L9-0AF

NOTE



Table description

- Bold values in the table indicate the default settings.
- The setting items or setting values with "*" may not be displayed depending on the availability of the optional accessories and other settings.

About the icons

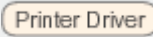
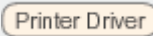
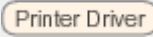
 : The settings for the printer driver are prioritized for this item.

Setting Item	Setting Value	Setting
[Resolution]	[600 dpi] , [1200 dpi]	Specify the print resolution for processing print data. <ul style="list-style-type: none"> • [600 dpi] is suited for printing ordinary documents and spreadsheets at fast speeds. • [1200 dpi] provides a high level of resolution to reproduce fine details such as text and layout or drawing borders faithfully and clearly. It is especially suited for printing data containing small font sizes and thin lines.
[Image Refinement]	[Off], [On]	Set whether to use the smoothing process to print the jagged edges of text and graphics. <ul style="list-style-type: none"> • When this setting is set to [On], the smoothing process is performed. • When this setting is set to [Off], no smoothing process is performed. <p>† The effect of the smoothing process varies depending on the gradation patterns of text, graphics, and images (such as drawings, tables, and graphs).</p> <p>† When [Resolution] is set to [1200 dpi], this setting is not displayed.</p>
[Toner Save] 	[Off] , [On]	[Toner Save] is used for test printing. When you use [Toner Save], you can save toner when you print.
[Density]* 	-8 Light -0- +8 Dark	Adjust the print density when printing. The larger the setting value, the greater the print density. <p>† When [Toner Save] is set to [On], this setting is unselectable.</p>
[Density (Fine Adj)]* 	[High]: -8 Light -0- +8 Dark [Mid]: -8 Light -0- +8 Dark [Low]: -8 Light -0- +8 Dark	Fine-tune the toner density for printing. <p>† When [Toner Save] is set to [On], this setting is unselectable.</p>
	[Text]: [Resolution] , [Gradation], [Color Tone], [High Resolution]	Specify the halftone display method when printing. <ul style="list-style-type: none"> • [Resolution] allows you to print in fine detail so that the edges of text data can be seen clearly. It is suitable for printing data containing text and fine lines. •

<p>[Halftones]</p> <p>Printer Driver</p>	<p>[Graphics]: [Resolution], [Gradation], [Color Tone], [High Resolution]</p> <p>[Image]: [Resolution], [Gradation], [Color Tone], [High Resolution]</p>	<p>[Gradation] allows you to perform printing that combines smooth gradation with edge quality. It is suitable for printing graphics or graphs that use gradation.</p> <ul style="list-style-type: none"> • [Color Tone] allows you to print with a sharp gradation and well-balanced texture, contrasting light and shade, which is best suited for printing photo images. • [High Resolution] is that it is possible to print at a higher resolution than [Resolution] or [Gradation], but texture stability is slightly inferior. It is suitable for printing data containing text and fine lines and data such as CAD data that is printed with sharp edges.
<p>[Reduce Quality]</p>	<p>[Continue Printing], [Stop Printing]</p>	<p>Specifies whether the printer should continue printing with the image quality of the data being lowered automatically or stop printing displaying the following error message when the memory required for the process runs out.</p> <ul style="list-style-type: none"> • If [Continue Printing] is specified, the printer prints with the image quality level being lowered automatically without displaying a message. • If [Stop Printing] is specified, the printer stops printing, displaying a message. In this case, the printer resumes printing with the image quality of the data being lowered by pressing [] ( : Online).

[Setup] Menu ([Interface] Options)

04L9-0AH

NOTE

Table description

- Bold values in the table indicate the default settings.
- After changing the setting items with "**1", cycle the power of the printer or perform a hard reset to make the settings effective.
- The setting items or setting values with "**2" may not be displayed depending on the availability of the optional accessories and other settings.

Setting Item	Setting Value	Setting
[Interface Selection] ^{*1}		Specifies the settings for the interfaces used for communication with the computer or other device.
[USB]	<ul style="list-style-type: none"> • [Use USB Connection]: [Off], [On] • [Recog. USB Connect.]: [Mode 1], [Mode 2] 	<ul style="list-style-type: none"> • [Use USB Connection] Specifies whether to use the USB interface. <ul style="list-style-type: none"> • [Recog. USB Connect.] Switches the USB connection recognition mode. Normally, set it as [Mode 1].
[Network]	[Off], [On]	Specifies whether to use the network interface.
[USB Storage Device] ^{*2}	[MEAP Driver]: [Off] , [On]	Specifies the setting for the device driver when using USB memory devices.
[Timeout]	<ul style="list-style-type: none"> • [Timeout]: [Off], [On] • [Timeout Time]^{*2}: 5 to 15 to 300 seconds 	Specifies the function to finish a job automatically.
[Connection Recog.] ^{*1}	[Off], [On]	When you print using the standard network, you may not obtain proper printout results. (Unreadable characters are printed, overlay printing fails, etc.) In this case, specify [Off] for this item.
[Extended RX Buffer] ^{*1*2}	[Off] , [On]	If this item is set to [On], the memory capacity of the printer's receive buffer that receives the data is increased. You can speed up the time the computer exits when you send a large amount of data or complicated data from the computer.

[Setup] Menu ([User Maintenance] Options)

04L9-0AJ

NOTE

Table description

- Bold values in the table indicate the default settings.
- The setting items or setting values with "*" may not be displayed depending on the availability of the optional accessories and other settings.

Setting Item	Setting Value	Setting
[Adj. Start Position]	<ul style="list-style-type: none"> • [Offset Y (MP Tray)]: -5.0 to 0.0 to +5.0 (mm) • [Offset X (MP Tray)]: -5.0 to 0.0 to +5.0 (mm) • [Offset Y (Drawer 1)]: -5.0 to 0.0 to +5.0 (mm) • [Offset X (Drawer 1)]: -5.0 to 0.0 to +5.0 (mm) • [Offset Y (Drawer 2)]*: -5.0 to 0.0 to +5.0 (mm) • [Offset X (Drawer 2)]*: -5.0 to 0.0 to +5.0 (mm) • [Offset Y (2-Sided)]: -5.0 to 0.0 to +5.0 (mm) • [Offset X (2-Sided)]: -5.0 to 0.0 to +5.0 (mm) 	<p>Specifies the printing position of the paper in the specified paper source. Adjusts the position in the vertical direction (Y) or the horizontal direction (X) by the specified value.</p> <p>The setting values are indicated in millimeters (mm), and you can adjust the position using [▲] and [▼].</p> <p>If you do not adjust the printing position, specify [0.0] for this item.</p> <p>Adjust the printing position for 2-sided printing as follows.</p> <ul style="list-style-type: none"> • Adjust the printing position of the first page using [Offset Y (2-Sided)] and [Offset X (2-Sided)]. • The printing position of the second page depends on the settings for each paper source. <p>▶ "Adjusting the Printing Position for Each Paper Source"</p>
[Recovery Printing]	[Off], [On]	Specifies whether to print the partially printed page when the printer stops printing due to a paper jam or an error occurring.
[Check Paper Size]	[Off] , [On]	Specifies whether the printer should stop printing, displaying the message <Check paper size.> or continue printing when [MP Tray Paper Size],

		[Drawer 1 Size], [Drawer 2 Size] is set to [Mixed Sizes].						
[Substitute Size]	[Off], [On]	<p>When the paper of the target size is not loaded in the printer, the printer prints on paper of the following sizes.</p> <table border="0"> <thead> <tr> <th style="text-align: center;">Size of the Paper to Be Printed</th> <th style="text-align: center;">Printer Driver Setting</th> </tr> </thead> <tbody> <tr> <td style="text-align: center;">Letter</td> <td style="text-align: center;">→ A4</td> </tr> <tr> <td style="text-align: center;">A4</td> <td style="text-align: center;">→ Letter</td> </tr> </tbody> </table>	Size of the Paper to Be Printed	Printer Driver Setting	Letter	→ A4	A4	→ Letter
Size of the Paper to Be Printed	Printer Driver Setting							
Letter	→ A4							
A4	→ Letter							
[Special Print Mode A]	[Off], [Mode 1], [Mode 2], [Mode 3], [Mode 4]	<p>Depending on the paper type or the operating environment, vertical streaks may appear on the printed paper. In this case, change the setting for this option. Improving effectiveness for vertical streaks increases in the following order.</p> <p>[Off] (Effectiveness: low) ↓ [Mode 1] ↓ [Mode 2] ↓ [Mode 3] ↓ [Mode 4] (Effectiveness: high)</p> <p>Even if you do not change the setting due to change in paper type or operating environment, this may also avoid vertical streaks appearing on the printed paper. As improving effectiveness increases, print density decreases. This may also make outlines appear to be blurred or slightly jagged.</p>						
[SD Card Maintenance]								
[Format]	[No], [Yes]	Delete the contents of the SD card.						
[Special Print Mode]								
[Plain Ppr. Curl Corr]	[Off], [Mode 1], [Mode 2]	<p>If printed plain paper curls, set this item to [Mode 1]. If the problem is not solved by specifying [Mode 1], specify [Mode 2].</p> <p>If the printer produces sound during printing, selecting [Mode 1] or [Mode 2] may also reduce the noise.</p> <p>➤ "Printing Silently"</p>						
[Plain 16K Output Adj]	[Off], [On]	If 16K plain paper cannot be output completely, set this item to [On].						
[Update Firmware]								
[USB]	—	This option is to be executed only when the firmware of the printer needs to be updated.						
[Network]	—							
[Paper Feed Method]	<ul style="list-style-type: none"> • [Multi-Purpose Tray]: [Speed Priority], [Print Side Priority] • [Drawer 1]: [Speed 	<p>Specifies on which side of the loaded paper the printer should print. Perform printing after selecting the paper drawer or tray to feed paper. Select the paper source.</p> <p>➤ "[Setup] Menu ([Paper Source] Options)"</p> <p>The setting of this item determines which side of paper is printed on. Load the paper in proper orientation.</p> <p>➤ "Paper Loading Orientation"</p> <ul style="list-style-type: none"> • If [Speed Priority] is specified, the printing sides of the paper for 1-sided printing and 2-sided printing do not match. 						

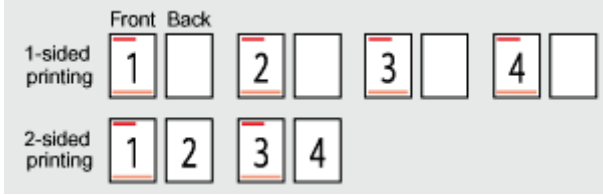
	<p>Priority, [Print Side Priority]</p> <ul style="list-style-type: none"> [Drawer 2]*: <p>Speed Priority, [Print Side Priority]</p>	 <ul style="list-style-type: none"> If you specify [Print Side Priority], the printer matches the printing sides of the paper for 1-sided printing and 2-sided printing. Therefore, when you print previously printed paper, you do not need to reload the paper each time you switch between the settings.  <p>† If you specify [Print Side Priority], the print speed drops.</p>
[Show Job List]	[Off], [On]	<p>Specifies whether to display the job list when [●] (⚙️/🔧: Job Status/Cancel) is pressed.</p> <ul style="list-style-type: none"> If [On] is specified, the printer displays the job list. If [Off] is specified, the printer does not display the job list.
[IMPORT/EXPORT]	[EXPORT] , [IMPORT]	<p>You can save and read printer settings.</p> <p>➤ "Importing and Exporting Settings"</p>

[Setup] Menu ([Print Mode] Options)

04L9-0AK

NOTE

Table description

- Bold values in the table indicate the default settings.
- The setting items or setting values with "*" may not be displayed depending on the availability of the optional accessories and other settings.

Setting Item	Setting Value	Setting
[Auto Mode Selection]	[Auto Selection] , [PCL], [PS]*, [PDF], [XPS]*	Specifies the mode in which this printer operates when you print without using the printer driver for this printer. If the print mode is not appropriate, such a printing problem as unreadable characters being printed may occur. Specify this item according to the job to be printed.
[Auto Select]	<ul style="list-style-type: none">• [PCL]: [Off], [On]• [PS]* [Off], [On]• [PDF]: [Off], [On]• [XPS]*: [Off], [On]	Specifies the print mode to be automatically switched if [Auto Mode Selection] is set to [Auto Selection]. If [On] is specified, the mode is to be automatically switched to.
[Mode Priority]	[None] , [PCL], [PS]*, [PDF], [XPS]*	You can specify [Mode Priority] to be switched to by priority for when [Auto Mode Selection] is set to [Auto Selection] and this printer cannot identify the control command of the data. If you specify [None], the printer does not specify the mode priority. If this printer cannot identify the control command of the data, it determines the mode automatically.

[Setup] Menu ([UFR II] Options)

04L9-0AR

 **NOTE**

Table description

Bold values in the table indicate the default settings.

Setting Item	Setting Value	Setting
[Paper Save]	[Off], [On]	Specifies whether the printer outputs the blank page that can be created due to no data existing in the page data sent from an application.

[Setup] Menu ([PCL] Options)

04L9-0AL

NOTE

Table description

- Bold values in the table indicate the default settings.
- The setting items or setting values with "*" may not be displayed depending on the availability of the optional accessories and other settings.

Setting Item	Setting Value	Setting
[Paper Save]	[Off] , [On]	Specifies whether the printer outputs the blank page that can be created due to no data existing between two Form Feed codes sent from an application.
[Orientation]	[Portrait] , [Landscape]	Enables you to set the paper orientation.
[Font Number]	0 to 104	Enables you to set the default font for this printer function using the corresponding font numbers. Valid font numbers are from 0 to 104.
[Point Size]*	4.00 to 12.00 to 999.75 point	If the number selected in [Font Number] is that of a proportionally spaced scalable font, this option appears in the [PCL] options. It enables you to specify a point size for the default font. The point size can be adjusted in increments of 0.25 pts.
[Pitch]*	0.44 to 10.00 to 99.99 cpi	If the number selected in [Font Number] is that of a fixed pitch scalable font, Pitch appears in the [PCL] options. It enables you to specify the pitch for the default font. The pitch can be adjusted in increments of 0.01 cpi (characters per inch).
[Form Lines]	5 to 64 to 128 lines	Enables you to specify the number of lines to be printed on a page. You can specify from 5 to 128 lines.
[Character Code]	[PC8] , [ROMAN8], [ROMAN9], [ISOL1], [ISOL2], [ISOL5], [ISOL6], [ISOL9], [PC775], [PC8DN], [PC850], [PC852], [PC858], [PC8TK], [PC1004], [WINL1], [WINL2], [WINL5], [WINBALT], [DESKTOP], [PSTEXT], [LEGAL], [ISO4], [ISO6], [ISO11], [ISO15], [ISO17], [ISO21], [ISO60], [ISO69], [WIN 30], [MCTEXT], [PC864], [ARABIC8], [WINARB], [PC866], [ISOCYR], [WINCYR], [PC851], [GREEK8], [ISOGRK], [PC8GRK], [WINGRK], [PC862], [HEBREW7], [HEBREW8], [ISOHEB]	Enables you to select the symbol set most suited to the needs of the host computer.
[Custom Size]	[Do Not Set] , [Set]	Enables you to specify a custom paper size. If [Set] is selected, you can enter a custom size.
[Unit of Measurement]*	[Millimeters] , [Inches]	Enables you to specify the unit of measurement you would like to use to specify your custom paper size.
[X Dimension]*	76.2 to 215.9 mm; 215.9 mm (3.00 to 8.50 in.; 8.50 in.)	Enables you to specify the X dimension of the custom paper. The X dimension can be adjusted between 76.2 mm and 215.9 mm in increments of 0.1 mm.

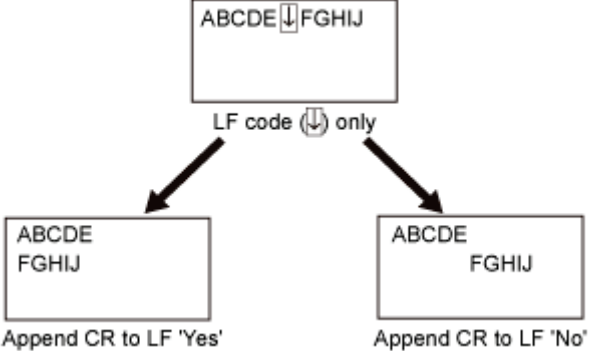
[Y Dimension]*	127.0 to 355.6 mm; 355.6 mm (5.00 to 14.00 in.; 14.00 in.)	Enables you to specify the Y dimension of the custom paper. The Y dimension can be adjusted between 127.0 mm and 355.6 mm in increments of 0.1 mm.
[Append CR to LF]	[Yes], [No]	<p>Enables you to specify whether to append a carriage return (CR) when line feed code (LF) is received.</p> 
[Enlarge A4 Prt Width]	[Off] , [On]	Determines whether to expand the printable area of A4 paper to that of Letter size in width.
[BarDIMM]*	[Enable], [Disable]	You can enable or disable the Bar Code Printing function of the printer.
[FreeScape]*	[Off], [~] , ["], [#], [\$], [/], [N], [?], [{, [}], [I]	You can specify the AEC (Alternate Escape Code) to be used for bar code commands when the host computer does not support the standard Escape Code.

[Setup] Menu ([Imaging] Options)

04L9-0AS

NOTE

Table description

- Bold values in the table indicate the default settings.
- The setting items or setting values with "*" may not be displayed depending on the availability of the optional accessories and other settings.

Setting Item	Setting Value	Setting
[Image Orientation]	[Auto] , [Vertical], [Horizontal]	Specifies whether the printer should print an image in portrait (vertical) orientation or in landscape (horizontal) orientation.
[Zoom]	[Off] , [Auto]	Specifies whether the printer should print with scaling outputs according to the printable area.
[Print Position]	[Auto] , [Center], [Top Left]	Specifies the printing position for an image.
[Print Guarantee]*	[Off] , [On]	<p>Set the processing method for received TIFF data.</p> <ul style="list-style-type: none"> • When it is set to [Off], the processing time is shortened by processing received TIFF data sequentially. • When it is set to [On], it is possible to prevent errors from occurring, since all the TIFF data is received before processing begins. However, the printing speed will drop. <p>† After specifying, perform a hard reset or restart the printer to enable the settings.</p>
[Show Warnings]	[Off], [Print] , [Panel]	Specifies the display setting for the error message in case of an error occurring.
[Print E-Mail Text]	[Off], [On]	Set e-mail print.
[Limit E-Mail Print]	[Off] , [On]	<ul style="list-style-type: none"> • "Receiving E-mail Data on the Mail Server and Printing (E-mail Print)"
[Enlarge Print Area]	[Off] , [On]	Specifies whether the printer should print a document with its printable area expanded.
[Halftones]	[Resolution], [Gradation] , [High Resolution]	<p>Specify the halftone display method when printing.</p> <ul style="list-style-type: none"> • When it is set to [Resolution], you can perform printing that combines smooth gradation with edge quality. It is suitable for printing graphics or graphs that use gradation. • When it is set to [Gradation], you can print with a sharp gradation and well-balanced texture, contrasting light and shade, which is best suited for printing photo images. • When it is set to [High Resolution], you can print in fine detail so that the edges of text data can be seen clearly. It is suitable for printing data containing text and fine lines.
[Grayscale Conversion]	[sRGB], [NTSC] , [Uniform RGB]	<p>Select the method for converting color print data to grayscale for printing.</p> <ul style="list-style-type: none"> • When it is set to [sRGB], it calculates the grayscale value using the sRGB standard color conversion method. • When it is set to [NTSC], it calculates the grayscale value using the NTSC standard color conversion method. • When it is set to [Uniform RGB], it takes the average value of the Red, Green and Blue color values as the grayscale value.

[Setup] Menu ([XPS] Options) (LBP6680x Only)

04L9-0AU

NOTE

Table description

Bold values in the table indicate the default settings.

Setting Item	Setting Value	Setting
[Halftones]	[Text]: [Resolution] , [Gradation], [High Resolution] [Graphics]: [Resolution] , [Gradation], [High Resolution] [Image]: [Resolution] , [Gradation], [High Resolution]	You can select the halftone display method from [Resolution], [Gradation] and [High Resolution]. <ul style="list-style-type: none"> • [Resolution] allows you to perform printing that combines smooth gradation with edge quality. It is suitable for printing graphics or graphs that use gradation. • [Gradation] allows you to print with a sharp gradation and well-balanced texture, contrasting light and shade, which is best suited for printing photo images. • [High Resolution] allows you to print in fine detail so that the edges of text data can be seen clearly. It is suitable for printing data containing text and fine lines.
[Grayscale Conversion]	[Text]: [sRGB] , [NTSC], [Uniform RGB] [Graphics]: [sRGB] , [NTSC], [Uniform RGB] [Image]: [sRGB] , [NTSC], [Uniform RGB]	Select the method for converting color print data to grayscale for printing. <ul style="list-style-type: none"> • When it is set to [sRGB], it calculates the grayscale value using the sRGB standard color conversion method. • When it is set to [NTSC], it calculates the grayscale value using the NTSC standard color conversion method. • When it is set to [Uniform RGB], it takes the average value of the Red, Green and Blue color values as the grayscale value.
[Compressed Img Mode]	[Image Priority] , [Output Priority]	Choose how the printer behaves in case the printer is running low on memory when printing an XPS file. <ul style="list-style-type: none"> • When [Image Priority] is selected, printing is performed with the image quality given a higher priority. If the printer is running low on memory, printing is cancelled. • When [Output Priority] is selected, this may degrade the image quality, but printing can still be performed. <p>† When [SD Card] is set to [On], the quantity of XPS files increases that can print with the image quality given a higher priority. It may well also be the case that printing is cancelled, if the printer is running low on memory.</p>
[Compressed Img Outpt]	[Output] , [Display Error]	If output is given a higher priority, this may gradually degrade the image quality over time, depending on the type of print data. If this happens, continue printing by lowering the image quality or display an error message to decide whether to cancel printing. <ul style="list-style-type: none"> • When [Output] is selected, printing continues. • When [Display Error] is selected, an error message appears, and printing is cancelled. <p>† This setting is effective when [Compressed Img Mode] is set to [Output Priority], or when [SD Card] is set to [On].</p>

[Setup] Menu ([PDF] Options)

04L9-0AW

NOTE

Table description

Bold values in the table indicate the default settings.

Setting Item	Setting Value	Setting
[Fit to Page]	[Off] , [On]	Set it to enlarge or reduce to fit the effective print area of the specified paper. ↑ This setting fixes the aspect ratio and scales the page size of the PDF file.
[Enlarged Print Area]	[Off] , [On]	Set whether to expand the effective print area to the edges of the paper without leaving margins around the edges of the paper. ↑ When it is set to [On], images on the edges of the paper may be partially cut off.
[N on 1]	[Off] , [2 on 1], [4 on 1], [6 on 1], [8 on 1], [9 on 1], [16 on 1]	You can print multiple pages of the PDF file data arranged on one page. When multiple pages are printed, they are arranged from the top left.
[Comment Print]	[Off], [Auto]	Specify whether to print the comments inside the PDF file that are specified for printing.
[Halftones]	[Text]: [Resolution] , [Gradation], [High Resolution] [Graphics]: [Resolution] , [Gradation], [High Resolution] [Image]: [Resolution] , [Gradation], [High Resolution]	You can select the halftone display method from [Resolution], [Gradation] and [High Resolution]. <ul style="list-style-type: none"> • [Resolution] allows you to perform printing that combines smooth gradation with edge quality. It is suitable for printing graphics or graphs that use gradation. • [Gradation] allows you to print with a sharp gradation and well-balanced texture, contrasting light and shade, which is best suited for printing photo images. • [High Resolution] allows you to print in fine detail so that the edges of text data can be seen clearly. It is suitable for printing data containing text and fine lines.
[Grayscale Conversion]	[sRGB], [NTSC] , [Uniform RGB]	Select the method for converting color print data to grayscale for printing. <ul style="list-style-type: none"> • When it is set to [sRGB], it calculates the grayscale value using the sRGB standard color conversion method. • When it is set to [NTSC], it calculates the grayscale value using the NTSC standard color conversion method. • When it is set to [Uniform RGB], it takes the average value of the Red, Green and Blue color values as the grayscale value.
[Dot Gain Adjustment]	[-10%], [-5%], [Standard] , [+5%], [+10%]	You can adjust dotted areas to change darkness and lightness of painted areas. A higher number specifies a darker printed area.

[Setup] Menu ([PS] Options)

04L9-0AX

NOTE

Table description

Bold values in the table indicate the default settings.

Setting Item	Setting Value	Setting
[Job Timeout]	0 to 3600 seconds	If the time specified in this item has elapsed since a job process was started, the printer automatically finishes the job and receives the next job. If you do not want to specify the timeout, specify "0 seconds."
[Print PS Errors]	[Off] , [On]	Specifies whether an error page should be printed when a PostScript error is occurring.
[Halftones]	[Text]: [Resolution] , [Gradation], [High Resolution] [Graphics]: [Resolution] , [Gradation], [High Resolution] [Image]: [Resolution] , [Gradation], [High Resolution]	You can select the halftone display method from [Resolution], [Gradation] and [High Resolution]. <ul style="list-style-type: none"> • [Resolution] allows you to perform printing that combines smooth gradation with edge quality. It is suitable for printing graphics or graphs that use gradation. • [Gradation] allows you to print with a sharp gradation and well-balanced texture, contrasting light and shade, which is best suited for printing photo images. • [High Resolution] allows you to print in fine detail so that the edges of text data can be seen clearly. It is suitable for printing data containing text and fine lines.
[Grayscale Conversion]	[sRGB], [NTSC] , [Uniform RGB]	Select the method for converting color print data to grayscale for printing. <ul style="list-style-type: none"> • When it is set to [sRGB], it calculates the grayscale value using the sRGB standard color conversion method. • When it is set to [NTSC], it calculates the grayscale value using the NTSC standard color conversion method. • When it is set to [Uniform RGB], it takes the average value of the Red, Green and Blue color values as the grayscale value.
[Dot Gain Adjustment]	[-10%], [-5%], [Standard] , [+5%], [+10%]	You can adjust dotted areas to change darkness and lightness of painted areas. A higher number specifies a darker printed area.



[Setup] Menu ([MEAP Settings] Options) (LBP6680x Only)

04L9-0AY

NOTE

Table description

Bold values in the table indicate the default settings.

Setting Item	Setting Value	Setting
[Select Def. Screen]	[Print Screen] , [MEAP]	<p>Set the initial screen of the control panel that is displayed after the printer starts up.</p> <ul style="list-style-type: none">• When it is set to [Print Screen], the printer's print standby screen is displayed.• When it is set to [MEAP], the MEAP menu screen is displayed. <p>† After the printer starts, you can toggle the menu screens by pressing [] (: Application) on the control panel.</p>

[Setup] Menu ([Check Counter] Options)

04L9-0C0

Setting Item	Setting Value	Setting
[Check Counter]	<ul style="list-style-type: none">▪ LBP6680x [113: Total (Black/S)]▪ LBP6670dn (Display only)	<p>Check the number of pages printed.</p> <ul style="list-style-type: none">▪ LBP6680x [113: Total (Black/S)]: Number of single-sided pages printed in black and white <p>☒ "Checking the Number of the Printed Pages"</p>

NOTE

Table description

The setting items or setting values with "*" may not be displayed depending on the availability of the optional accessories and other settings.

About samples

For Configuration Page, Network Status Print, and Printing Position Adjustment Print, see the following.

➤ ["The Lists Common to All the Settings in the Print Mode"](#)

Setting Item	Setting Value	Setting
[Check Counter]	<ul style="list-style-type: none"> LBP6680x [113: Total (Black/S)] LBP6670dn (Display only) 	Check the number of pages printed. <ul style="list-style-type: none"> LBP6680x [113: Total (Black/S)]: Number of single-sided pages printed in black and white ➤ "Checking the Number of the Printed Pages"
[Configuration Page]	-	Prints the capacity of the built-in memory (RAM) or the contents specified in the common [Setup] menu. You can select this item regardless of the setting for the print mode.
[Network Status Print]	-	Prints the version number and the settings of the print server equipped with this printer.
[IPSec Policy List]*	-	Print the IPSec policy that is registered in the printer.
[PCL Utility]	[Font List]	A list of the fonts that can be used in the PCL mode is printed.
[PS Utility]*	[Configuration Page] , [Font List]	<ul style="list-style-type: none"> [Configuration Page] Prints the content specified in the [PS] options. [Font List] A list of the fonts that can be used in the PS mode is printed.
[Cleaning]	[A4] , [LTR]	The printer cleans the fixing roller by printing a cleaning page. ➤ "Cleaning the Fixing Roller of the Printer"
[E-Mail Print Utility]	[Received E-Mails] , [Received E-mail List]	Manage e-mail printing. ➤ "Receiving E-mail Data on the Mail Server and Printing (E-mail Print)"
[Printing Pos. Print]	-	The printing position adjusted in [Adj. Start Position] is printed. Check the printout results to confirm the setting for [Adj. Start Position]. ➤ "Adjusting the Printing Position for Each Paper Source"
[Page Count List]	-	If department ID management is set, print an aggregate report of the number of pages printed by each department.
[Counter Report]	-	Print an aggregate report of the number of pages printed for each counter. ➤ "Checking the Number of the Printed Pages"
[Print MEAP Sys. Info]	-	Print information about applications installed on MEAP and parts of the system applications.
[Total Printed Pages]*	-	Display the total number of pages printed up to now.
[Serial Number]	(Display only)	Displays the serial number of the printer.
		<ul style="list-style-type: none"> [Paper Information]

[Consumables]	[Paper Information] , [Toner Cart. Model], [Remaining Toner]	Displays information about the loaded paper such as size, type, and remaining amount for each paper source. <ul style="list-style-type: none">• [Toner Cart. Model] Displays the model numbers of the toner cartridges.• [Remaining Toner] Displays the amount of toner remaining in the cartridge. You can use this item to estimate when the toner cartridge will need to be replaced.
---------------	---	---

 **NOTE**

Table description

- The items and setting values marked with "*1" may or may not be displayed depending on the availability of the optional accessories or the content of the setting.
- The items and setting values marked with "*2" are only displayed when the check box for [Display Job History] is selected on the Remote UI.

Setting Item	Setting Value	Setting
[Encrypted Print] ^{*1}	User Name, Job Name, [PIN]	Print secure jobs stored on the SD card or encrypted secure jobs. "Specifying a Password for a Document and Printing (Secured Print) (LBP6680x Only)"
[Secured Print] ^{*1}	User Name, Job Name, [PIN]	
[Stored Job List] ^{*1}	-	Print the list of jobs stored on the SD card.
[Stored Job Print] ^{*1}	[Box No.N] (N=1 to 100), [PIN], Job Name	
[Job Print Log List] ^{*2}	-	Prints the job logs printed from the computer. File names, print dates, and other information are printed on the job log list.
[Stored Job Print Log] ^{*1*2}	-	Print the history of jobs printed from BOX.
[Report Print Log] ^{*2}	-	Prints the logs of the printed Configuration Page and Network Status Print.
[E-Mail Print Log] ^{*2}	-	Print the history of jobs received by e-mail and printed.

[Reset] Menu

04L9-0C3

Setting Item	Setting Value	Setting
[Soft Reset] ([Hard Reset])	-	Resets the printer when a problem is occurring or you want to cancel printing. ❖ "Canceling the Process Currently Being Performed (Soft Reset)" ❖ "Canceling All the Jobs (Hard Reset)"
[Form Feed]	-	When a job is canceled from the computer or the data is less than one page, the data may remain in the printer memory, and the job may not be completed properly. As long as the printer remains in this state, you cannot print the next job because the printer cannot receive the next data. In this case, force the printer to output the print data using the procedure for this item. ❖ "Outputting Data (Forced Output)"
[Shut Down]	-	Shuts down the functions of the printer. If you are using WSD printing, the shutdown notifies the computer that the printer is turned OFF. After executing a shut down, the printer cannot receive data, and panel operation becomes invalid. Cycle the power of the printer if you want to print the data again. ❖ Turning the Printer ON/OFF

[Select Feeder] Menu

04L9-0C4

NOTE

Table description

- Bold values in the table indicate the default settings.
- The setting items or setting values with "*" may not be displayed depending on the availability of the optional accessories and other settings.

About the icon

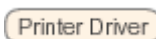

The settings for the printer driver are prioritized for this item.

Setting Item	Setting Value	Setting
[Paper Source] 	[Auto] , [Drawer 1], [Drawer 2]*, [Multi-Purpose Tray]	Selects the paper drawer or tray from which the printer feeds paper. After a paper source is selected, the corresponding Paper Source indicator comes on.
[MP Tray Paper Size]	[A6], [A5], [B5], [A4] , [LTR], [LGL], [EXEC], [Mixed Sizes], [Custom Size], [Custom Size R], [Env. ISO-C5], [Env. Monarch], [Env. No.10], [Env. DL], [Env. ISO-B5], [Index Card], [STMT], [16K]	Specifies the size of the paper loaded in the multi-purpose tray. ❖ "Registering the Paper Size"
[MP Tray Priority]	[Off] , [On]	Specifies whether the printer should detect the paper source in order starting with the multi-purpose tray when [Paper Source] is set to [Auto].
[Drawer 1 Size]/[Drawer 2 Size]*	[A6], [A5], [B5], [A4] , [LTR], [LGL], [EXEC], [Mixed Sizes], [Custom Size], [Custom Size R], [16K]	Specifies the size of the paper loaded in the paper drawer. ❖ "Registering the Paper Size"
[Standard Paper Size]	[A6], [A5], [B5], [A4] , [LTR], [LGL], [EXEC], [Env. ISO-C5], [Env. Monarch], [Env. No.10], [Env. DL], [Env. ISO-B5], [Index Card], [STMT], [16K]	If you cannot specify the paper size or if you print from DOS, UNIX, or other operating system, specify the paper size in this item. ❖ "Loading Paper in the Paper Drawer" ❖ "Loading Paper in the Multi-purpose Tray"
[Diff. Paper Tray]	[Off] , [On]	Specifies whether the printer should feed paper from the multi-purpose tray when paper of the size for the received data is not loaded in the paper drawer.
[Auto Selection]	[Multi-Purpose Tray]: [Off], [On] [Drawer 1]: [Off], [On] [Drawer 2]*: [Off], [On]	Specifies the paper source to be automatically selected when [Paper Source] is set to [Auto] in " [Select Feeder] Menu ." If [On] is specified, the printer selects the paper source as the one to be automatically selected.
[Default Paper Type]	[Plain] , [Plain L], [Heavy 1], [Heavy 2], [Transparency], [Envelope], [Labels]	Specifies whether the printer should print on one side or both sides of the paper.
[2-Sided Printing]	[Off] , [On]	Specifies whether the printer should print

Checking the Number of the Printed Pages

04L9-0C5

If you want to check the number of the printed pages, use either of the following methods.

- ❖ [Checking the Counter Using the Printer's Control Panel](#)
- ❖ [Checking the Counter Using a Web Browser \(Remote UI\)](#)

Checking the Counter Using the Printer's Control Panel

You can check the number of the printed pages using the control panel.

1

Press [] ( : Settings).

2

Select [Check Counter] using [] or [], and then press [OK].

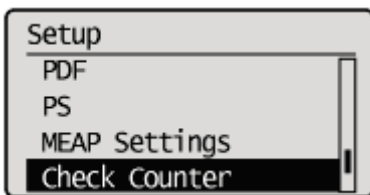

3

Select the counters to check using [] and [], and then press [OK]. (LBP6680x only)

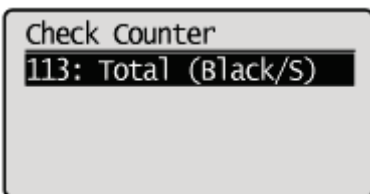

4

Check the number of the printed pages.

LBP6680x

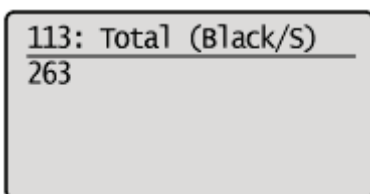

LBP6670dn

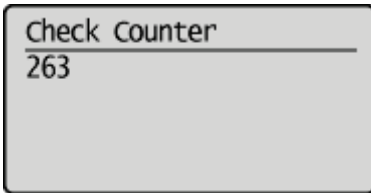

Checking the Counter Using a Web Browser (Remote UI)

You can check the number of the printed pages using the Remote UI.

1

Start the Remote UI, and then log in as Administrator.

➤ "Starting the Remote UI"

2

Select [Check Counter] from the [Status Monitor/Cancel] menu.

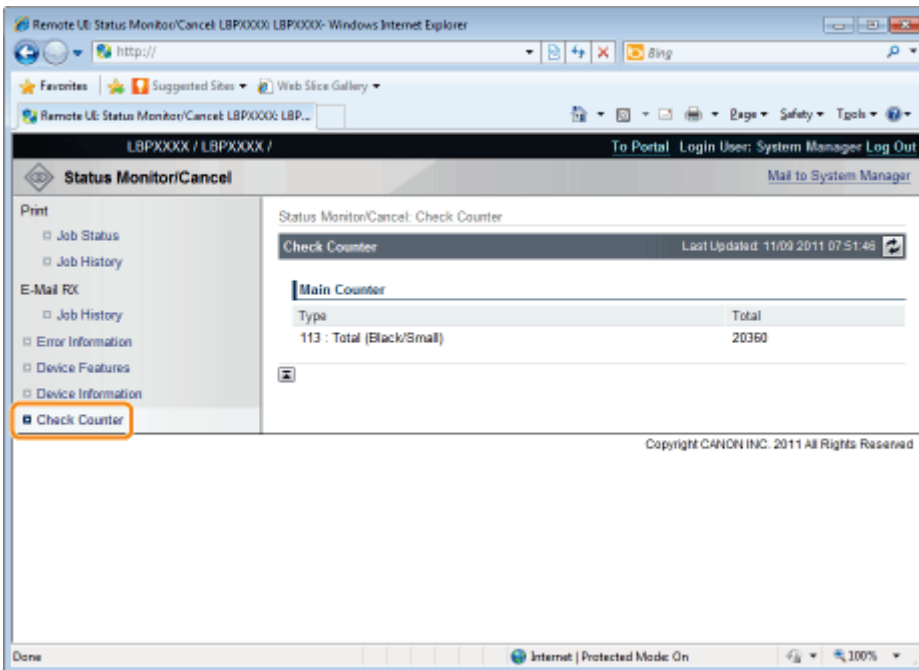

3

Check the number of the printed pages.

Remote UI: Status Monitor/Cancel LBPXXXX LBPXXXX- Windows Internet Explorer

http://

Remote UI: Status Monitor/Cancel LBPXXXX: LBP...

LBPXXXX / LBPXXXX / To Portal Login User: System Manager Log Out

Status Monitor/Cancel

Print

- Job Status
- Job History

E-Mail RX

- Job History
- Error Information
- Device Features
- Device Information
- Check Counter**

Status Monitor/Cancel: Check Counter

Check Counter Last Updated: 11/09/2011 07:51:48

Main Counter

Type	Total
113 : Total (Black/Small)	20360

Copyright CANON INC. 2011 All Rights Reserved

Done Internet | Protected Mode: On 100%

Importing and Exporting Settings

04L9-0C6

You can save (export) printer settings that are set in the operation panel or Remote UI to USB memory devices or SD cards. In addition, you can read (import) saved printer settings any time.

IMPORTANT

About USB memory support

- The file format FAT32 is supported only.
- USB memory drives cannot be read by this printer if:
 - these drives are partitioned
 - these drives contain encrypted data

Printers that can be imported

- You can import the settings only to the same model from which you export the settings.

NOTE

When saving/reading settings using USB memory devices and SD cards

Connect a USB memory device or an SD card to the printer's USB port or SD card slot. The saving location/writing source priority is shown below.

"USB memory" > "SD card"

Saving Printer Settings (Export)

Save printer settings to USB memory devices or SD cards (LBP6680x only).

1

Insert the USB memory device or the SD card (LBP6680x only) into the printer.

2

Press [] (↔ : Online).

The Online indicator goes off, allowing you to specify the settings on the control panel.

3

Press [] (☑ : Settings).

4

Select [User Maintenance] with [▲] and [▼], and then press [OK].

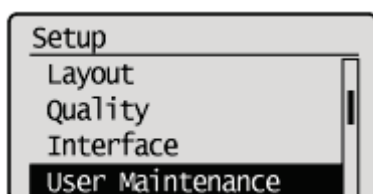

5

Select **[IMPORT/EXPORT]** with **[▲]** and **[▼]**, and then press **[OK]**.



6

Select **[EXPORT]** with **[▲]** and **[▼]**, and then press **[OK]**.

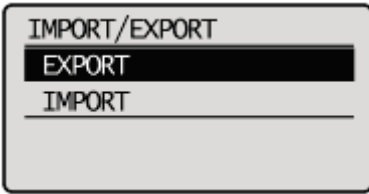

7

When **[Yes]** is selected using **[▼]**, and **[OK]** is pressed, the printer's settings are saved to the targeted saving location.

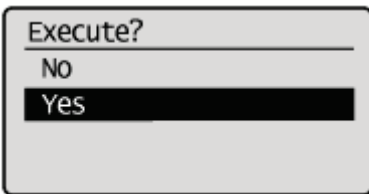

→ When the saving has finished, <Done.> is displayed.

Reading Printer Settings (Import)

Read printer settings that have been saved to USB memory devices or SD cards (LBP6680x only).

1

Insert the **USB memory device or the SD card (LBP6680x only)** into the printer.

2

Press **[○]** (**↔** : Online).

The Online indicator goes off, allowing you to specify the settings on the control panel.

3

Press **[]** (**[☑]** : Settings).

4

Select **[User Maintenance]** with **[▲]** and **[▼]**, and then press **[OK]**.

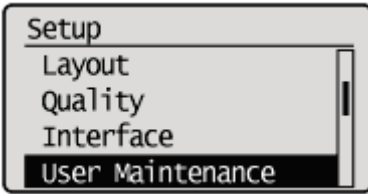

5

Select **[IMPORT/EXPORT]** with **[▲]** and **[▼]**, and then press **[OK]**.



6

Select **[IMPORT]** with **[▲]** and **[▼]**, and then press **[OK]**.

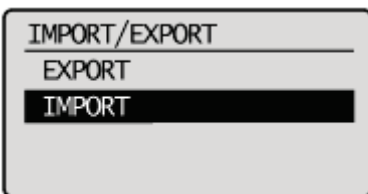

7

When **[Yes]** is selected using **[▼]**, and **[OK]** is pressed, the printer's settings are read from the targeted writing source.

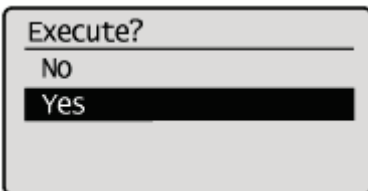

→ When the reading has finished, <Done.> is displayed.

8

Perform a hard reset or restart the printer.

After performing a hard reset or restarting the printer, the settings are effective.

NOTE

For details on a hard reset

Initializing the Settings

04L9-0C7

If you want to initialize the [Setup] menu using the control panel

You can restore the printer's common setup menus and dedicated setup menus to their default settings.

- "Initializing the [Setup] Menu Using the Printer's Control Panel"

If you want to initialize the network settings

You can reset the network settings for the printer to the default values.

- "Initializing the Network Settings"

NOTE

Initializing using NetSpot Device Installer

You can also initialize the network settings using NetSpot Device Installer.

For details on the procedure for initializing the network settings using NetSpot Device Installer, see Help.

- † Help is displayed by clicking [Help] in the [Help] menu.

Initializing the [Setup] Menu Using the Printer's Control Panel

04L9-0C8

Initialization of the [Setup] menu resets the settings specified in the common [Setup] menu and exclusive [Setup] menu to the default settings.

Initialize the settings by selecting [Initialize Menu] in the hierarchy of "Options" in the [Setup] menu. Start the key operation from Step 1.

IMPORTANT

Setting items which are not initialized

The following setting items are not initialized.

- [Network] Options
- [Adj. Start Position] ([User Maintenance] Options)

If <Initialize failed.> is displayed

If the message <Initialize failed.> appears when the initialization of the [Setup] menu is executed, the [Setup] menu is not initialized.

Make sure that the  (Job) indicator is off, and then perform [Initialize Menu] again.

Do not turn the printer OFF during the initialization.





The printer memory may be damaged.

About some setting items

Some setting items do not become effective unless you cycle the power of the printer or perform a hard reset after initializing the [Setup] menu.

NOTE

Canceling the initialization

If you press [] ( : Online) during the operation, the operation is canceled. However, you cannot cancel the operation when <Initializing...> is displayed even if you press [] ( : Online).

1

Press [] ( : Settings).

2

Select [Initialize Menu] using [] or [], and then press [OK].

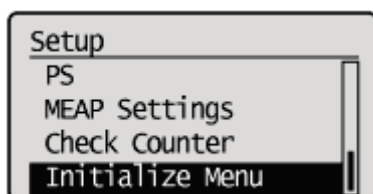

3

Select [Yes] using [], and then press [OK].

→ While the initialization is being performed, <Initializing...> is displayed.
<Init. complete.> is displayed after the initialization is completed.

Execute?

No

Yes

Checking the Printer Settings

04L9-0C9

You can check the printer status, network settings, and so on by printing Configuration Page or Network Status Print.

† Configuration Page or Network Status Print is designed to be printed on A4 paper. Be sure to use A4 paper.

† You can also check the network settings and so on using the following software.

- ❏ "Remote UI"
- ❏ "FTP Client"
- ❏ "NetSpot Device Installer"



1

Load A4 paper in the multi-purpose tray or paper drawer.

- ❏ "Paper Loading and Output"

2

Make sure that the printer is online (the  (Online) indicator is on).

If the  (Online) indicator is off, press [] ( : Online).

3

Press [] ( : Utility).

4

Select [Configuration Page] or [Network Status Print] using [] or [], and then press [OK].

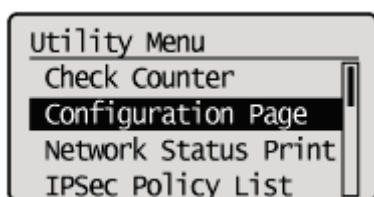

[Configuration Page]

Prints the list of currently available functions for the printer and setting values of the menus, and so on.

[Network Status Print]

Prints the TCP/IP settings including the IP address and information including security settings.

5

Select [Yes] using [], and then press [OK] to print Status Print.

Execute?

No

Yes

Setting the Administrator Password

04L9-OCA

Only the administrator (user who knows the password) can configure the settings or perform the operations related to the printer management by setting the administrator password.

Also, the administrator password can be changed anytime.

This section describes the procedure for specifying the settings using the Remote UI.

† In the Remote UI, you can specify the settings by accessing the printer from a Web browser via a network.

NOTE

When specifying the settings using software other than the Remote UI

You can also specify the settings using the following software.

▶ "FTP Client"

You can specify the settings by accessing the FTP server of the printer using Command Prompt.

1

Start the Remote UI, and then log in as Administrator.

▶ "Starting the Remote UI"

2

Select [Security] under [Management Settings] in the [Settings/Registration] menu.

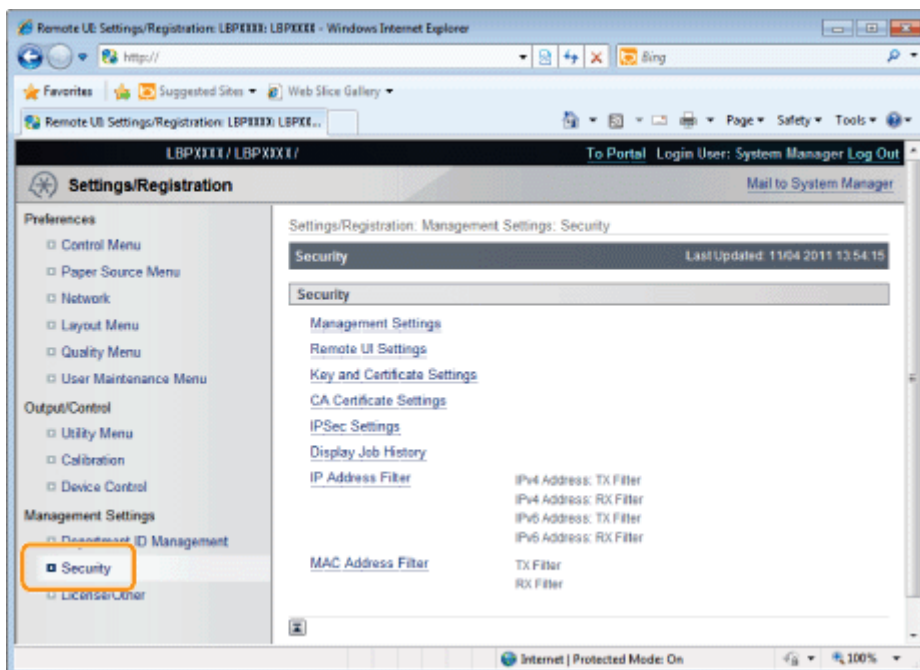

3

Click [Management Settings].

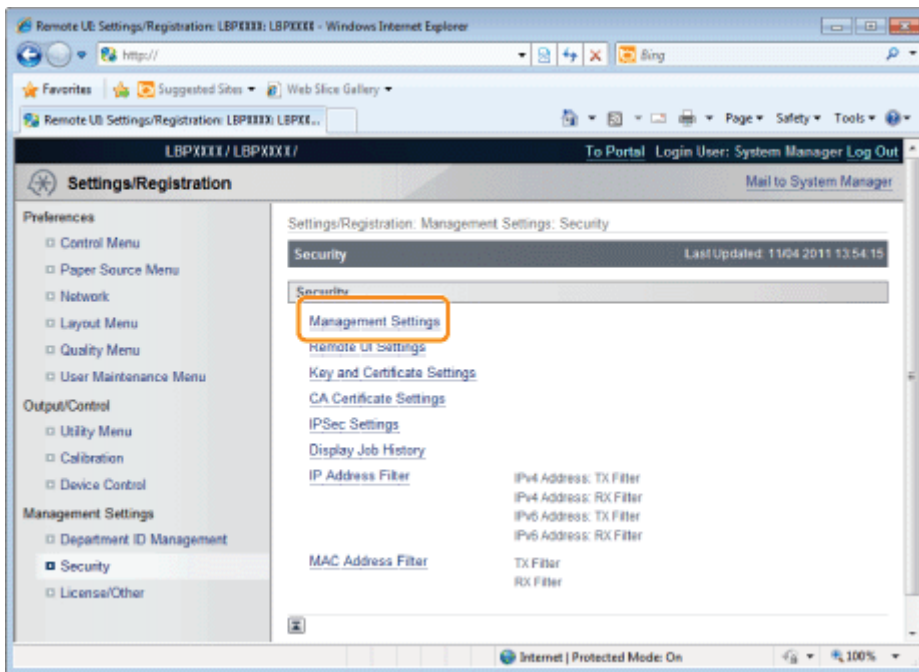

4

Click [Edit...] under [Management Settings].

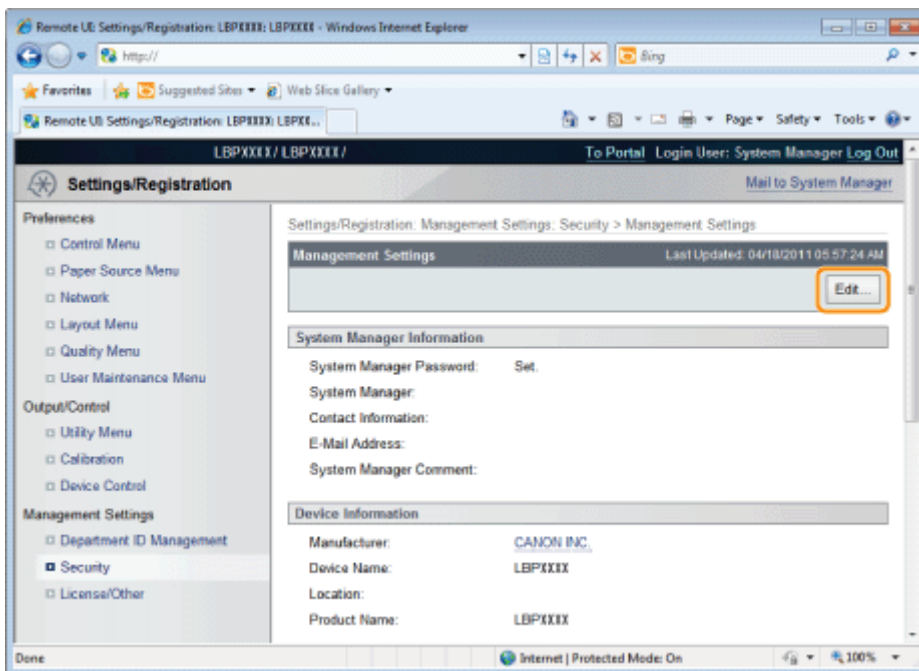

5

Enter the current password in [Current System Manager Password].

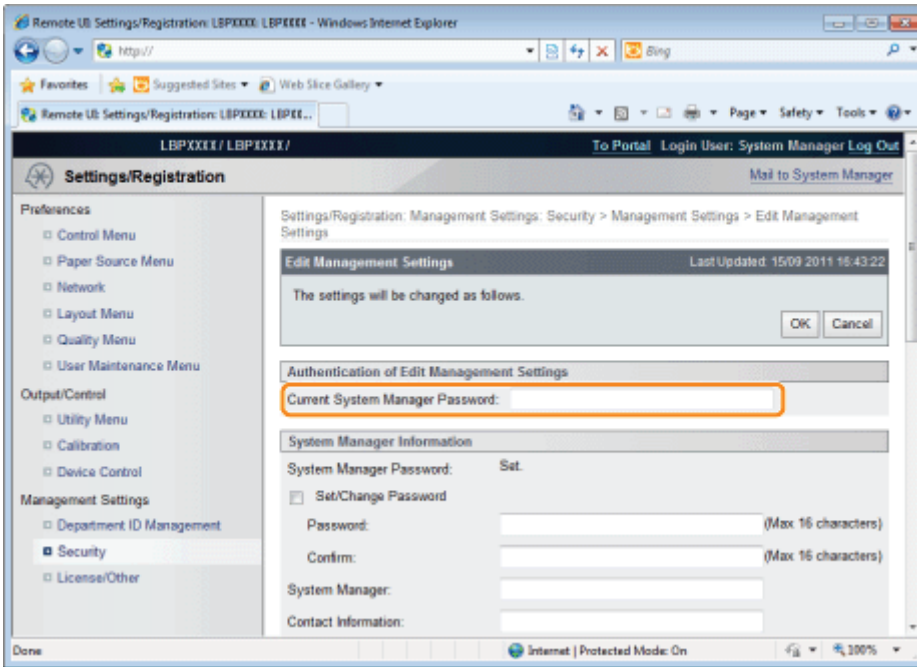

6

Set a new administrator password.

- (1) Select the [Set/Change Password] check box.
- (2) Enter the administrator password.
- (3) Click [OK].

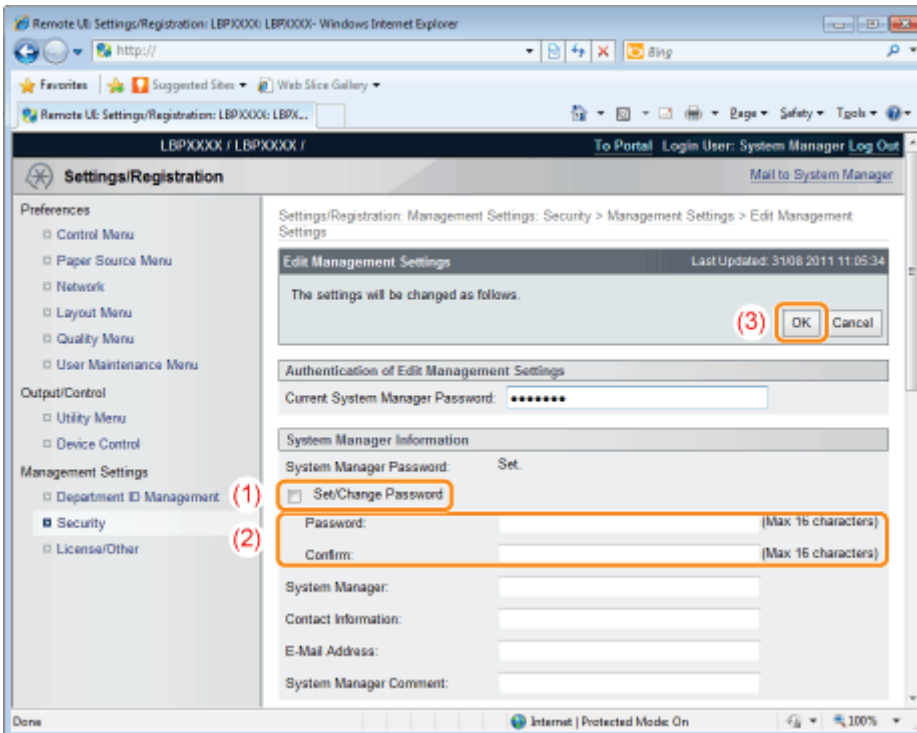

[Set/Change Password]	Select the check box when setting/changing the password.
[Password]	Enter a new desired password.
[Confirm]	To confirm the password, enter the password entered in [Password] again.

Specifying the Device Name or Administrator Information

04L9-0CC

This section describes the procedure for specifying the settings using the Remote UI.

† In the Remote UI, you can specify the settings by accessing the printer from a Web browser via a network.

NOTE

When specifying the settings using software other than the Remote UI

You can also specify the settings using the following software.

❖ "FTP Client"

You can specify the settings by accessing the FTP server of the printer using Command Prompt.

❖ "NetSpot Device Installer"

You can specify the settings using the Canon software, NetSpot Device Installer, in the supplied CD-ROM.

1

Start the Remote UI, and then log in as Administrator.

❖ "Starting the Remote UI"

2

Select [Security] under [Management Settings] in the [Settings/Registration] menu.

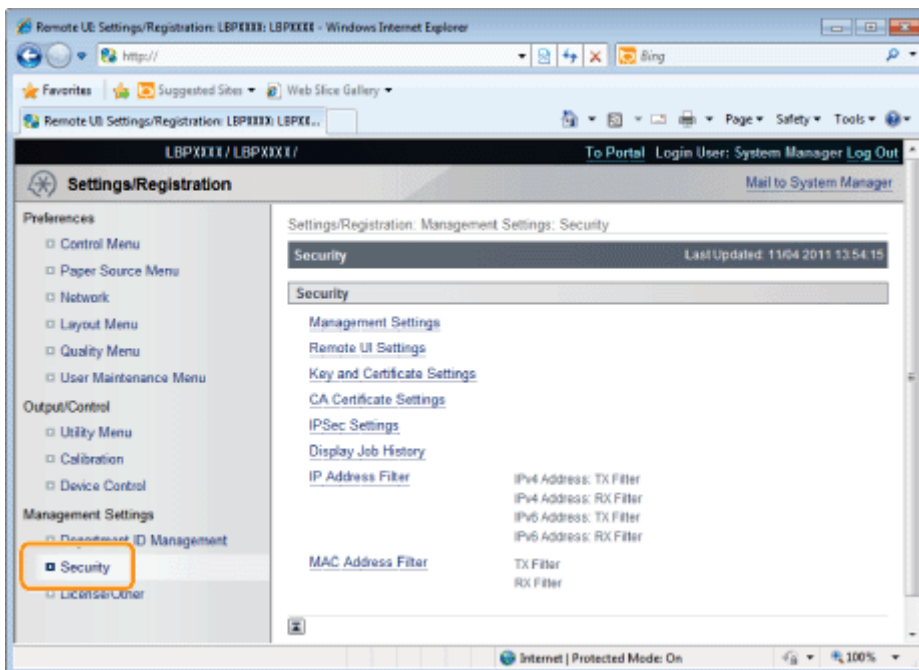

3

Click [Management Settings].

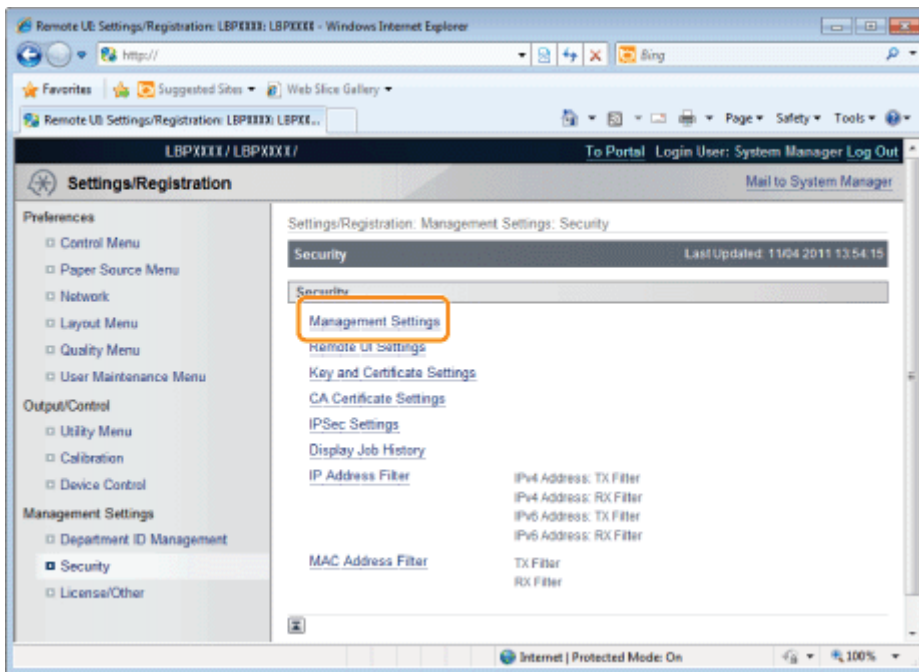

4

Click [Edit...] under [Management Settings].

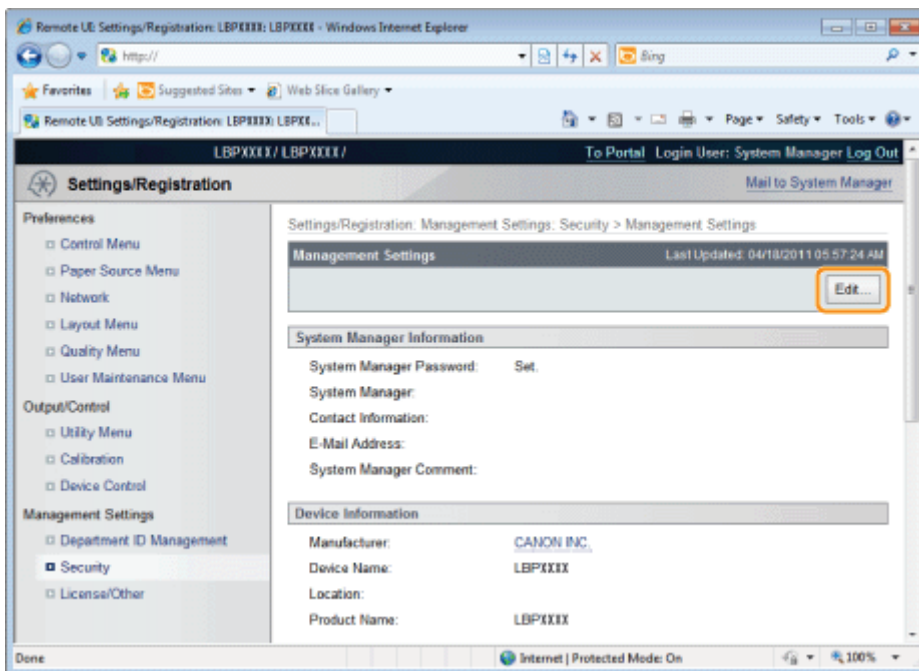

5

Enter the current password in [Current System Manager Password].

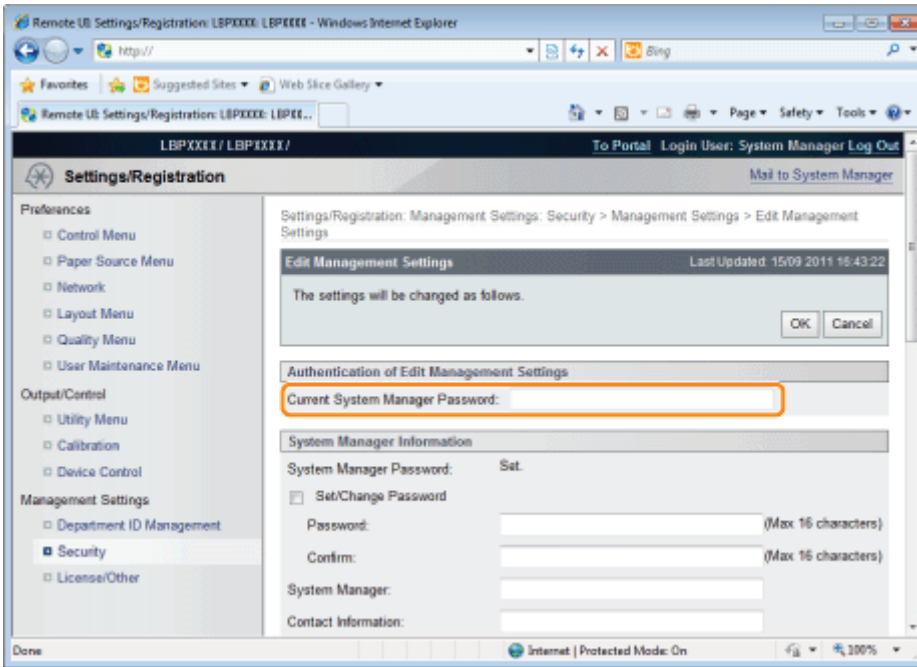

6

Specify the device name or administrator information.

- (1) Specify the settings for each option as needed.
- (2) Click [OK].

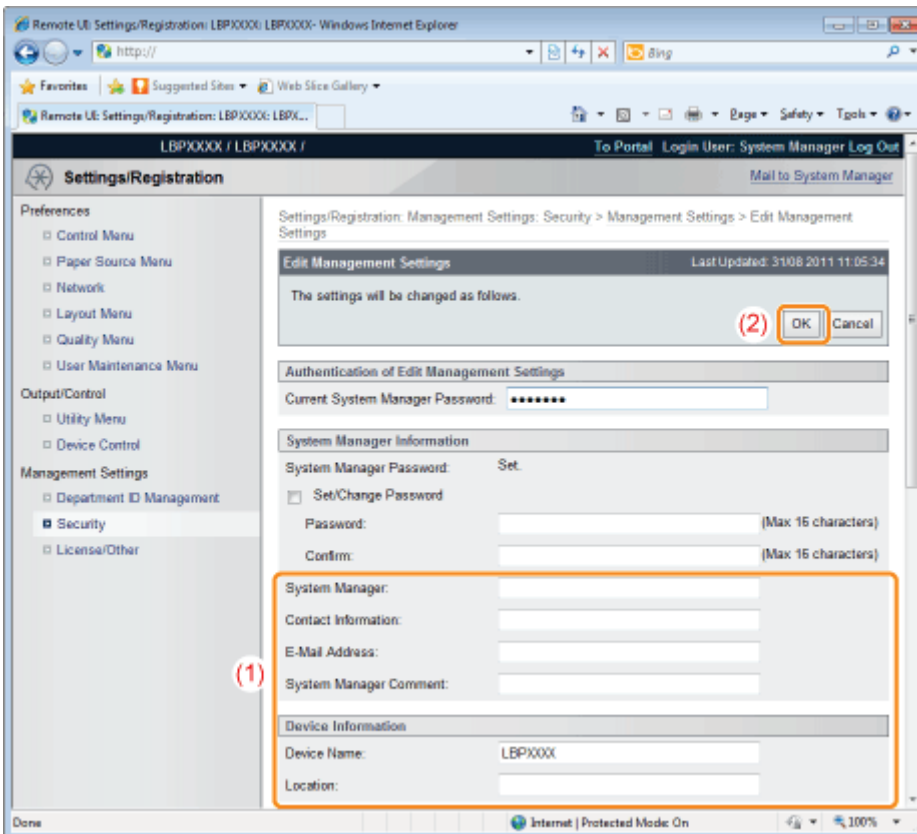

[System Manager]	Enter the name of the system manager.
[Contact Information]	Enter the system manager's contact information.
[E-Mail Address]	Enter the system manager's email address.
[System Manager]	Enter the system manager's comments.

Comment]	
[Device Name]	Enter the name of the printer.
[Location]	Enter the location of the printer.

Sleep Mode

04L9-OCE

You can specify the settings for sleep mode using the following procedures.

- ❖ ["Setting the Printer to Sleep Mode"](#)
- ❖ ["Sleep Mode Entering Conditions"](#)
- ❖ ["Releasing Sleep Mode"](#)

IMPORTANT

Power consumption when the power is OFF

Even if the printer is turned OFF, power is still consumed slightly while the power plug is inserted in the AC power outlet. To stop the power consumption completely, unplug the power plug from the AC power outlet.

Setting the Printer to Sleep Mode

There are the following four methods for setting the printer to Sleep Mode.

Setting the printer to Sleep Mode automatically when it is not operating	Specify the time interval until the printer enters Sleep Mode in [Sleep Migration Time]. You can specify the time interval between [5 minutes] and [60 minutes]. The default is [5 minutes]. † We recommend that you use this option in the default setting.
Setting the printer to Sleep Mode using the printer's control panel	Press [] (Energy Saver) on the printer's control panel.
Setting the printer to Sleep Mode from a network computer	Select [Sleep] from [Settings/Registration] on the Remote UI → [Output/Control] → [Device Control], and then click [Execute].
Setting the printer to Sleep Mode on the designated time every day	Set the [Sleep Mode Timer] under [Timer Settings] to [On], and then set the time when it automatically goes in the Sleep Mode in [Sleep Mode Time].

If the above operations or settings are performed, and the entering conditions described in ["Sleep Mode Entering Conditions"](#) are fulfilled, the printer enters Sleep Mode.

Sleep Mode Entering Conditions

The Sleep Mode entering conditions are as follows.

- Panel operation has not been performed.
- No data has been sent from the computer.
- The printer is not starting up.
- A shutdown is not being performed.
- [Sleep Even if Error] is set to [On].
- The following setting items in the [Network] options are set to [Off].
 - [WINS Resolution] in [TCP/IP Settings]
 - [IPSec] in [TCP/IP Settings] (LBP6680x only)
 - [AppleTalk]
 - [SMB Server] in [SMB] (LBP6680x only)
- The printer has not communicated on the network for more than 15 seconds.
- A USB cable is not connected.
- The SNTP or DHCP communication is not to be performed within 1 minute.
- It is not accessing USB memory or the SD card. (LBP6680x only)
- The Wake Up function is not to be performed within 1 minute.
-

- No jobs are waiting to print.
- No service calls have occurred.
- No paper jams have occurred.
- No cover is open.
- The toner cartridge is installed inside the printer.
- The toner cartridge has reached the end of its service life.
- The Ethernet driver is set to anything other than 1000Base-T.

 **NOTE**

To check whether the printer has entered Sleep Mode

You can check Sleep Mode using indicators on the control panel.

- Only the Main Power indicator comes on.

To configure the printer so that it does not enter Sleep Mode when an error occurs

Set [Sleep Even if Error] to [Off].

When using a utility software related to network

When you are using some type of utility software related to network and you set Sleep Mode to [High (Deep Sleep)], communications may fail. When using such type of utility software, please release Sleep Mode.

Releasing Sleep Mode

The following are the methods to release Sleep Mode.

Releasing Sleep Mode using the printer's control panel	Press the key on the printer's control panel. If the printer has entered Sleep Mode, you can release the mode when [] (Energy Saver) is pressed.
Releasing Sleep Mode on the designated time every day	Set the [Wake Up Timer] under [Timer Settings] to [On], and set the time when it automatically cancels the Sleep Mode in [Wake Up Time].
Releasing Sleep Mode from a computer	<ul style="list-style-type: none"> Send data to the printer. Perform the following in the Remote UI. <ul style="list-style-type: none"> Perform the operations in the [Output/Control] menu under [Settings/Registration] Display and set the [User Maintenance Menu] page in the [Preferences] menu under [Settings/Registration]

 **NOTE**

Sleep Mode is released also in the following cases.

- When the printer is connected to a network or receives the unicast packet.
- When devices on a network are searched from application software or utility software.

Auto Shutdown

04L9-0S9

You can specify the settings for auto shutdown using the following procedure.
This setting is made using the Remote UI.

1

Start the Remote UI, and then log in as Administrator.

➤ "Starting the Remote UI"

2

Click [Settings/Registration].

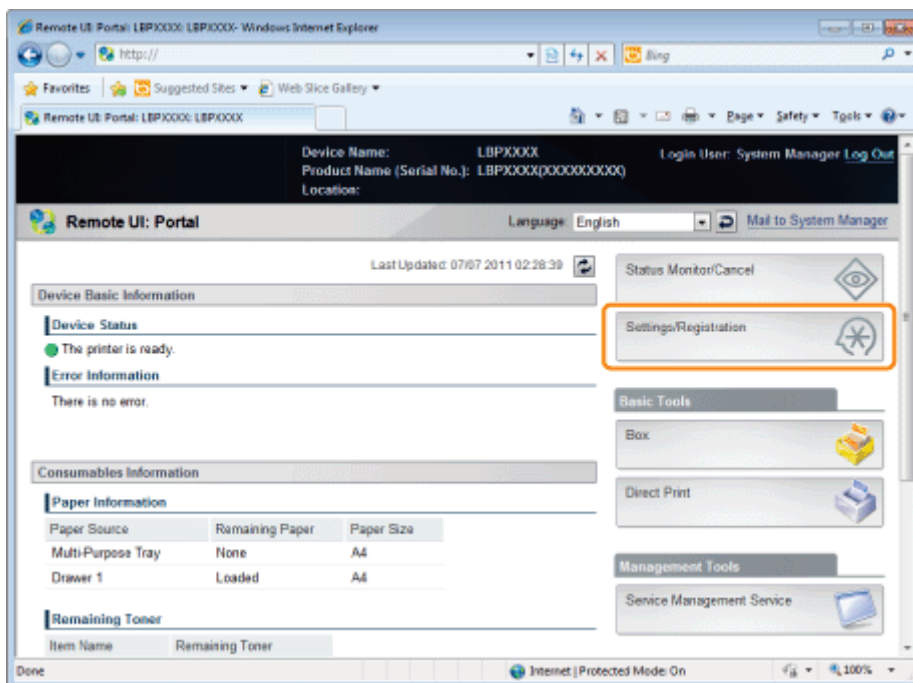

3

Select [Control Menu] from the [Preferences] menu.

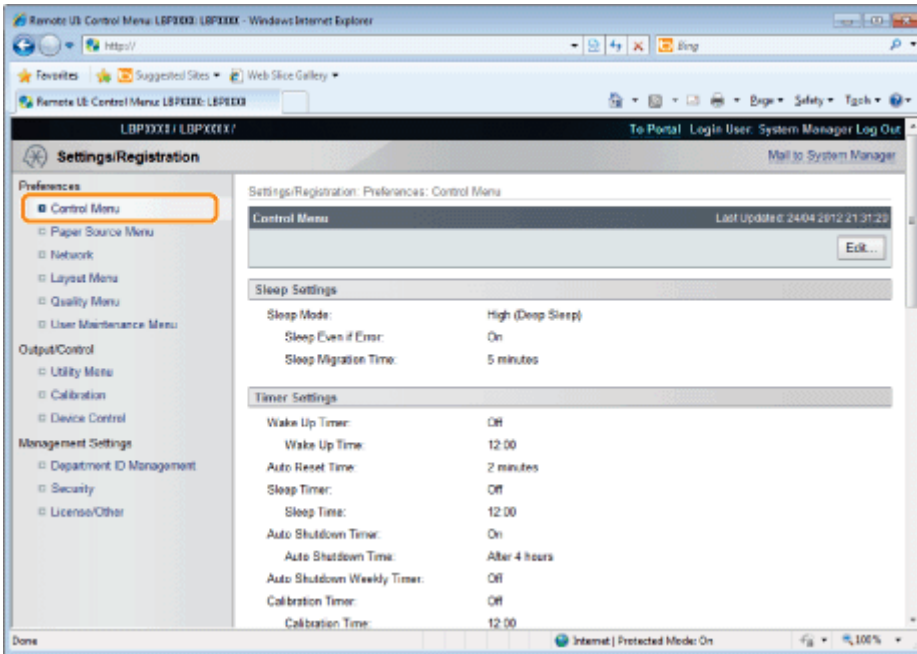

4

Click [Edit...].

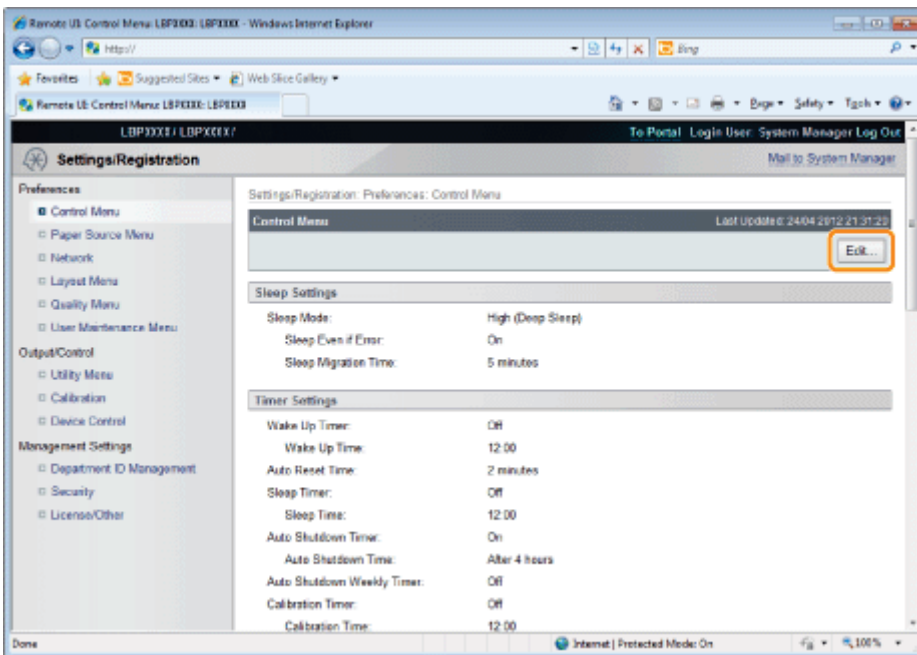

5

Specify the settings for auto shutdown.

(1) Select the [Use Auto Shutdown Timer] check box.

↑ The default setting is that it is enabled.

(2) Specify the time to shut down in [Auto Shutdown Time].

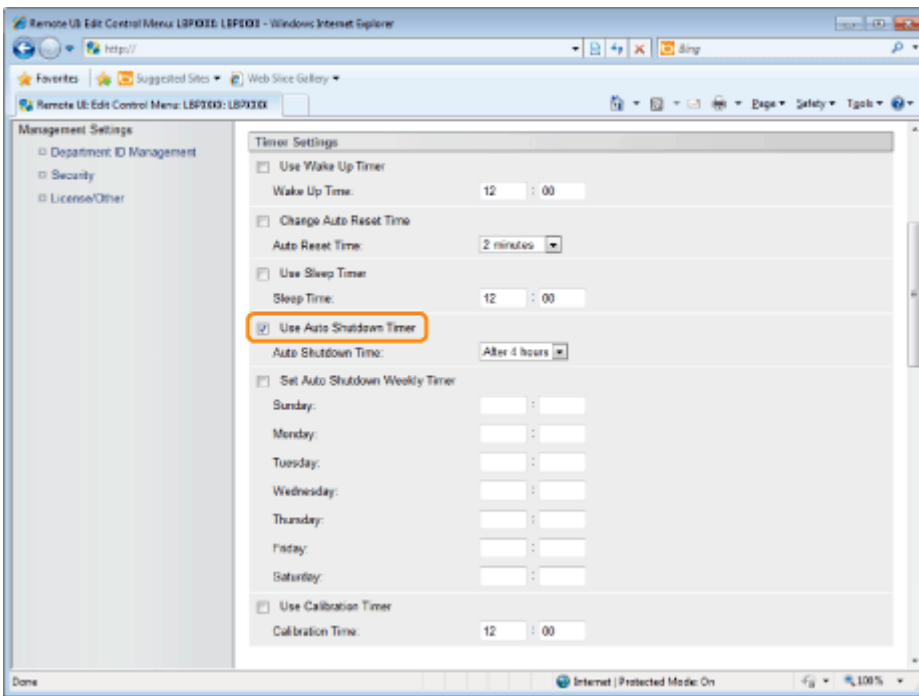

NOTE

About the setting for the time to execute auto shutdown

When [Auto Shutdown Time] is changed during sleep mode, the specified time to execute auto shutdown becomes effective in the following cases.

- When the printer is recovered from sleep
- When the power of the printer is cycled

You can specify [Auto Shutdown Time] for auto shutdown with 1 hour increments between [After 1 hour] and [After 8 hours].

- † If you specify the setting for this option shorter than the default setting, this may shorten the life of the toner cartridges (the default setting is "4" hours).

If the printer is not turned OFF immediately

Depending on the process in the printer, it may take up to 10 minutes to turn the printer OFF.

6

Set the auto shutdown weekly function as needed.

- (1) Select the [Set Auto Shutdown Weekly Timer] check box.
- (2) Specify the day and time when to execute auto shutdown.

- † All the default settings are that it is disabled.

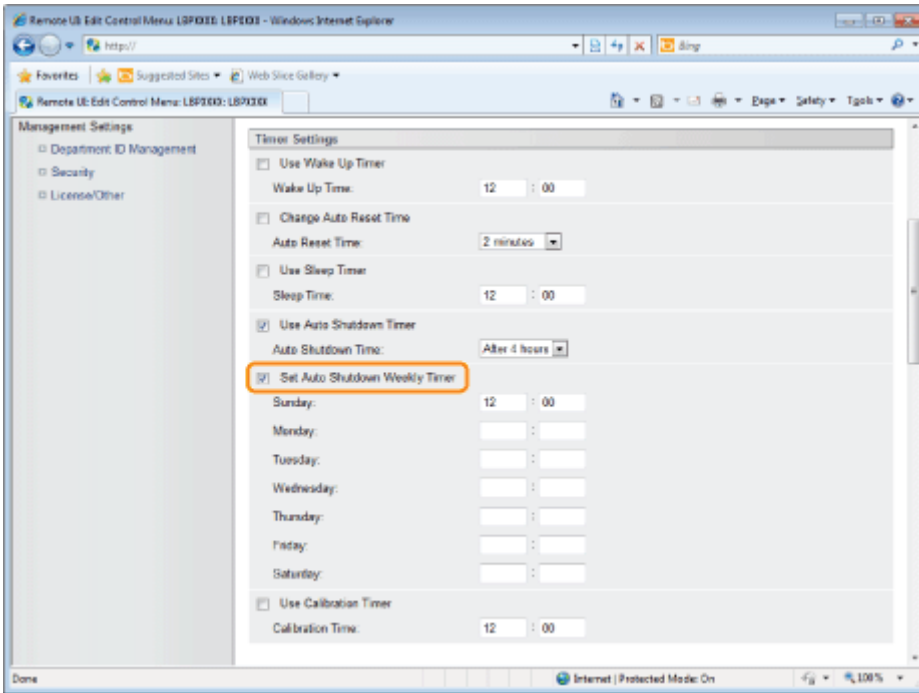

7

Click [OK].

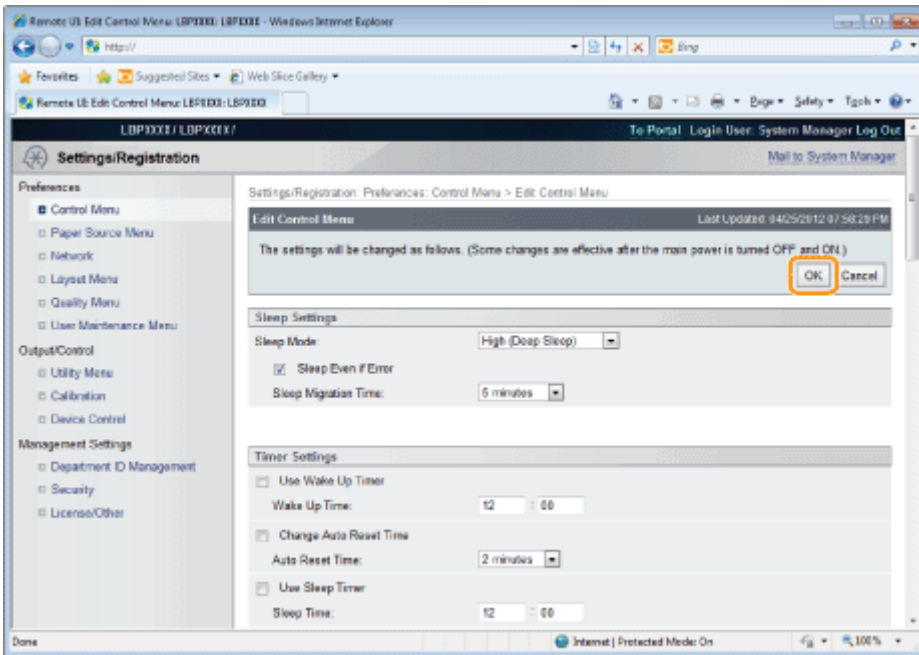

Printing Silently

04L9-0RX

If you find the printing noise to be too loud, you can reduce the operation noise by using Silent Mode. Use Silent Mode if you want to reduce the operating noise of the printer such as when printing at night.



† Using Silent Mode decreases the print speed.

❖ ["Performing Printing Always with Silent Mode"](#)

This section describes the setting procedure for Silent Mode so that printing is performed always with Silent Mode.

❖ ["Performing Printing with Silent Mode during a Designated Time"](#)

This section describes the setting procedure for Silent Mode so that printing is performed with Silent Mode during a designated time.

Performing Printing Always with Silent Mode

04L9-0RY

1

Press [] (↔ : Online).

The Online indicator goes off, allowing you to specify the settings on the control panel.

2

Press [] (☑ : Settings).

3

Select [User Maintenance] using [▲] and [▼], and then press [OK].

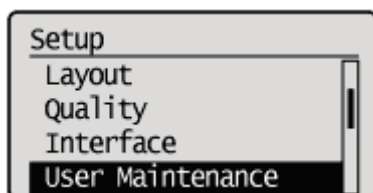

4

Select [Special Print Mode] using [▲] and [▼], and then press [OK].

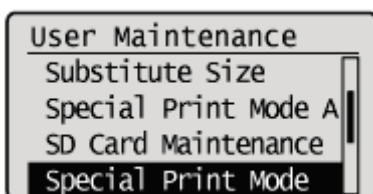

5

Select [Plain Ppr. Curl Corr] using [▲] and [▼], and then press [OK].

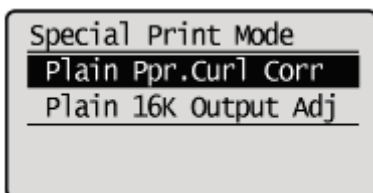

6

Select [Mode 1] or [Mode 2] using [▲] and [▼], and then press [OK].

Plain Ppr.Cur1 Corr
off
Mode 1
Mode 2

Performing Printing with Silent Mode during a Designated Time

04L9-0S0

1

Display the printer driver screen.

➤ "Printing with the Printer Driver"

2

Display the [Advanced Settings] dialog box.

- (1) Display the [Finishing] sheet.
- (2) Click [Advanced Settings].

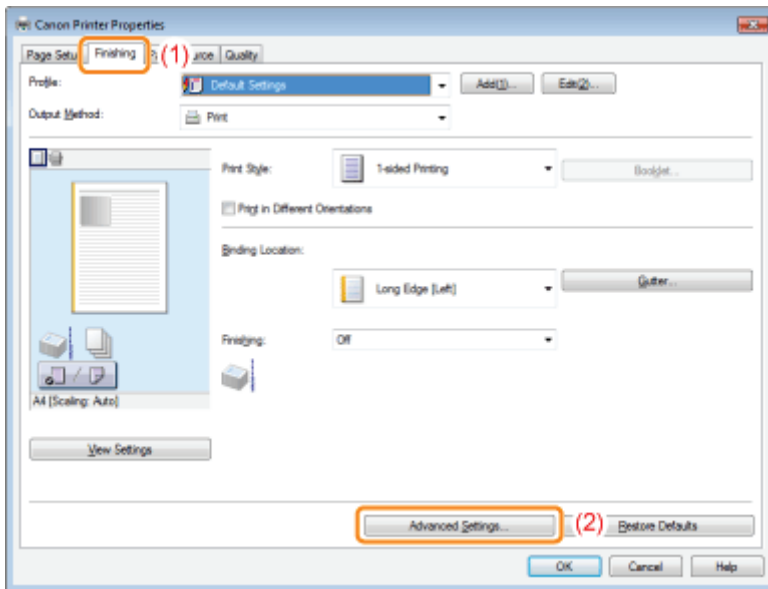

3

Specify Silent Mode.

- (1) Select [Special Print Mode [Plain Paper]].
- (2) Select [Mode 1] or [Mode 2].
- (3) Click [OK] to return to the [Finishing] sheet.

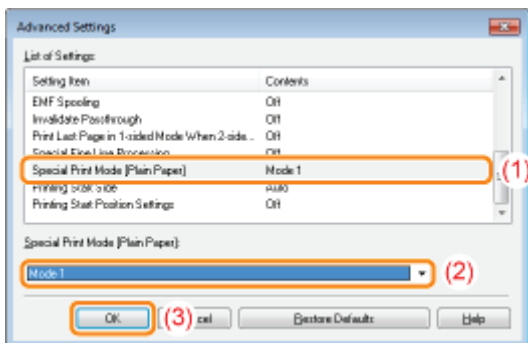

4

Click [OK].

† For details on the basic printing methods, see "[Printing Fundamentals](#)."

Specifying an ID for Each Department (LBP6680x Only)

04L9-OCF

Displaying or Changing the Departmental ID Management Settings

You can manage the number of [Printed Pages]* on a departmental basis by specifying IDs for each department and entering an ID when printing.

* [Printed Pages] indicates the number of printed surfaces. If you perform 2-sided printing on a sheet of paper, the number of the printed surfaces is two.

IMPORTANT

Register one or more Department IDs before enabling Department ID Management, which will have no effect with no Department ID registered.

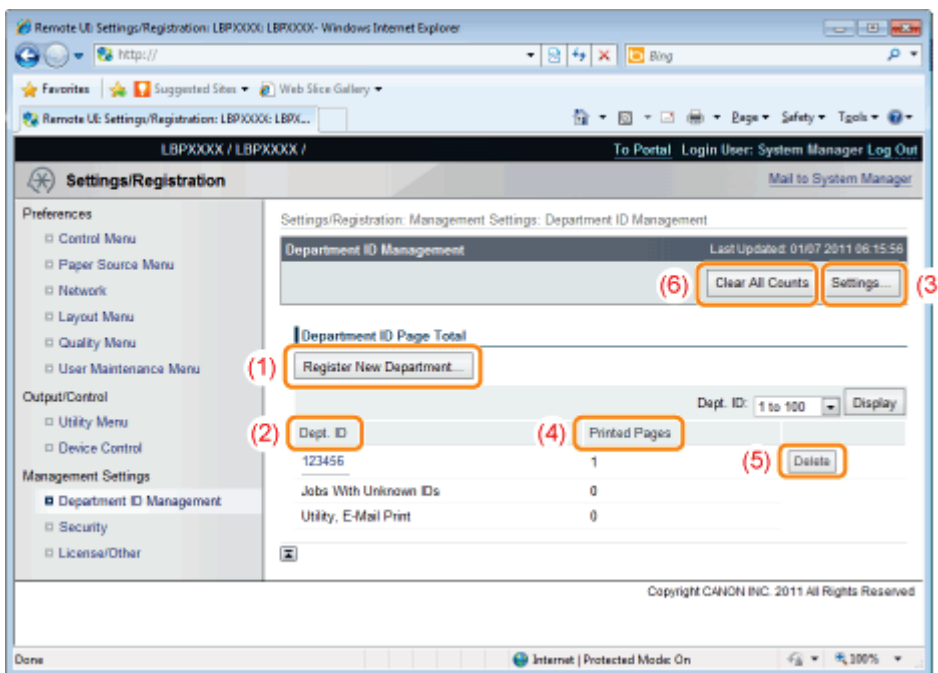

(1) [Register New Department]

(Displayed only if you have logged on in Administrator Mode.)

Clicking this button displays the [Register New Department] page. You can specify the following settings.

[Department ID]	Enter the department ID using a number with up to seven digits.
[PIN]	Enter the password using a number with up to seven digits.
[Confirm]	Enter the number specified in [PIN].

(2) [Dept. ID]

(Clickable only if you have logged on in Administrator Mode.)

Clicking the department ID displays the [Edit Department] page. You can specify the following settings.

[Department ID]	Enter the department ID using a number with up to seven digits.
[PIN]	Enter the password using a number with up to seven digits.
[Confirm]	Enter the number specified in [PIN].
[Clear Count]	(Not displayed depending on the settings.) Click [Printed Pages] ([Total Print]) for this Department ID.
[Total Print]	Displays the number of printed surfaces.

(3) [Settings...]

(Displayed only if you have logged on in Administrator Mode.)

Clicking this button displays the [Department ID Management Settings] page. You can specify the following settings.

[Enable Department ID Management]	If the check box for this option is selected, you need to enter a department ID and password when printing. You also need to enter a department ID and password when you perform direct printing or manipulate boxes from the Remote UI. Jobs which failed to be authenticated are deleted.
[Accept Print Jobs With Unknown IDs]	If the check box for this option is selected, you can print jobs with unknown IDs. Jobs with unknown IDs indicate the following kinds of jobs. <ul style="list-style-type: none">• Jobs printed by a printer driver which does not support the department ID management• Jobs directly printed using a method other than the Remote UI

(4) [Printed Pages]

Displays the number of printed surfaces.

(5) Delete the Selected Department

(Displayed only if you have logged on in Administrator Mode.)

If you click [Delete] to the right of the Dept. ID to be deleted, the selected Dept. ID is deleted.

(6) [Clear All Counts]

(Not displayed depending on the settings.)

Clears [Total Print] of all the departments.

Register/Update Software Function (LBP6680x Only)

04L9-0CH

➤ Available Functions

➤ Installing the System Options/MEAP Applications

- Installing by Connecting This Printer to an Outside Network (Delivery)
- Installing by Not Connecting This Printer to an Outside Network (Manual)
- Downloading the Manuals and Related Software

➤ Updating the Firmware

➤ Managing the Register/Update Software Function

Available Functions

04L9-0CJ

Installing the System Options/MEAP Applications

Using the Register/Update Software function, you can install the System Options/MEAP Applications to the printer. You can use this function from both the touch panel display and the computer (Remote UI).

Installing by Connecting This Printer to an Outside Network

You can install the System Options/MEAP Applications by accessing the delivery server from this printer.

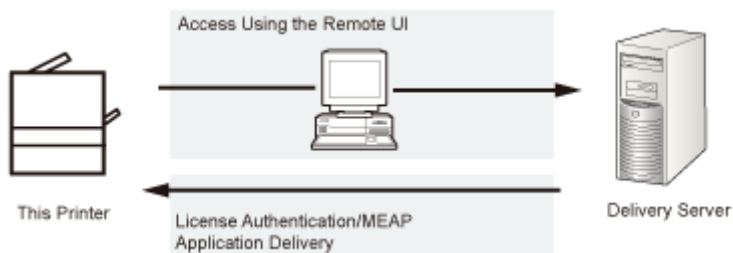

Installing by Not Connecting This Printer to an Outside Network

You can install the System Options/MEAP Applications by using the license file/license key that you obtained from the License Management System.

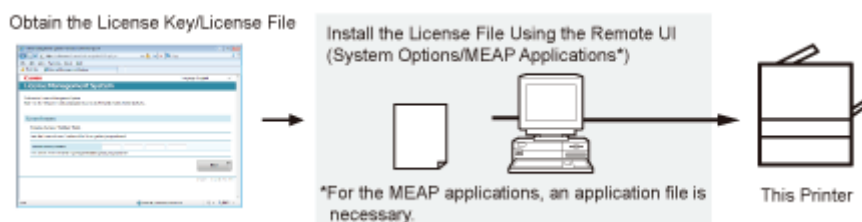

Updating the Firmware

Using the Register/Update Software function, you can update the firmware of the printer to the most recent version. You can use this function from the computer (Remote UI).

Updating by Connecting This Printer to an Outside Network

You can update the firmware by accessing the delivery server from this printer.

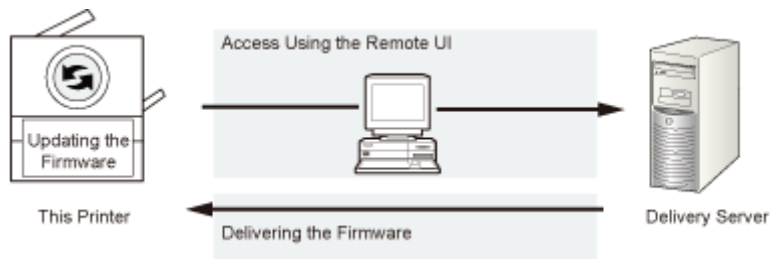

Installing the System Options/MEAP Applications

04L9-0CK

The procedures to install the system options or MEAP applications on the printer differ, depending on whether the printer is connected or not to an outside network. Select the procedure that matches your conditions using the references below.

Installing by Connecting this Printer to an Outside Network

Install from the Remote UI.

NOTE

Communication test

To check that the transmission with the delivery server is properly operating, if necessary, perform a communication test before installation.

["Testing Communication Using the Remote UI"](#)

Installing by Not Connecting this Printer to an Outside Network

Installing System Options

Install using one of the following procedures.

NOTE

If you install multiple system options

We recommend that you install from the Remote UI.

Procedure	Necessary Steps	Reference Page
Using the Remote UI to install	1. Obtain the license file from the License Management System	"Obtaining the License File"
	2. Install the license file using the Remote UI	"Installing the System Options Using the Remote UI"

Installing MEAP Applications

Use the following procedure to install.

Procedure	Necessary Steps	Reference Page
Using the Remote UI to install	1. Obtain the license file from the License Management System	"Obtaining the License File"
	2. Install the license file and application file using the Remote UI	"Installing the MEAP Applications Using the Remote UI"
	3. Start the MEAP applications from SMS	"Starting the MEAP Applications"

Installing by Connecting This Printer to an Outside Network (Delivery)

04L9-OCL

If the printer is connected to an outside network, you can install the system options and MEAP applications from the Remote UI by linking with the delivery server.

NOTE

Preparing a license access number certificate

Make sure that the license access number that is included with the package is available.

1

Start the Remote UI, and then log in as Administrator.

➤ "Starting the Remote UI"

2

From the top page of the Remote UI, click [Settings/Registration] → [License/Other] → [Register/Update Software].

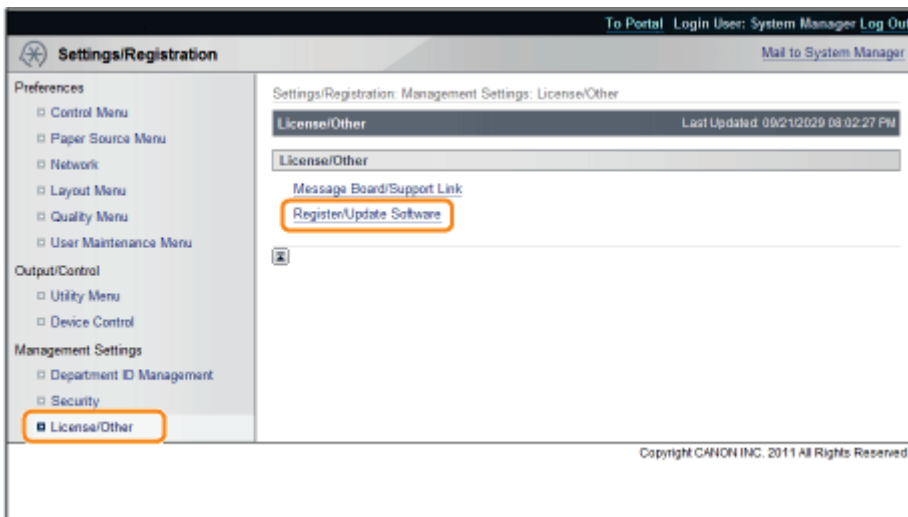

3

Click [Delivered Installation].

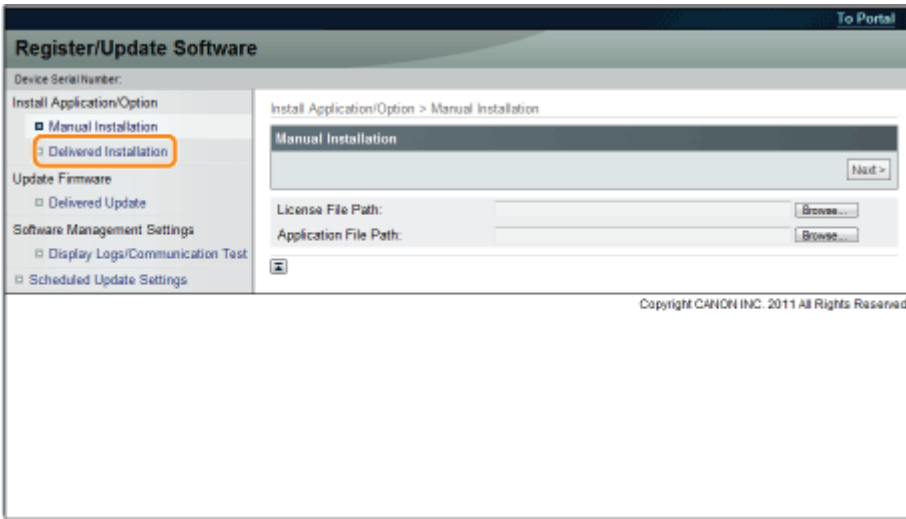

4

Enter the license access number → click [Next].

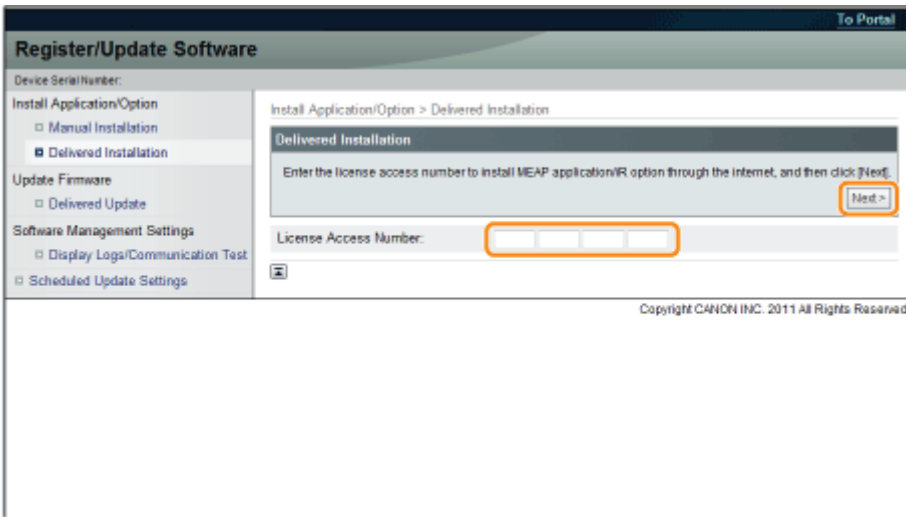

Once the license access number is confirmed after contacting the delivery server, information for the system options/MEAP applications you can install are displayed.

5

Select the system options and MEAP applications → click [Start Installation].

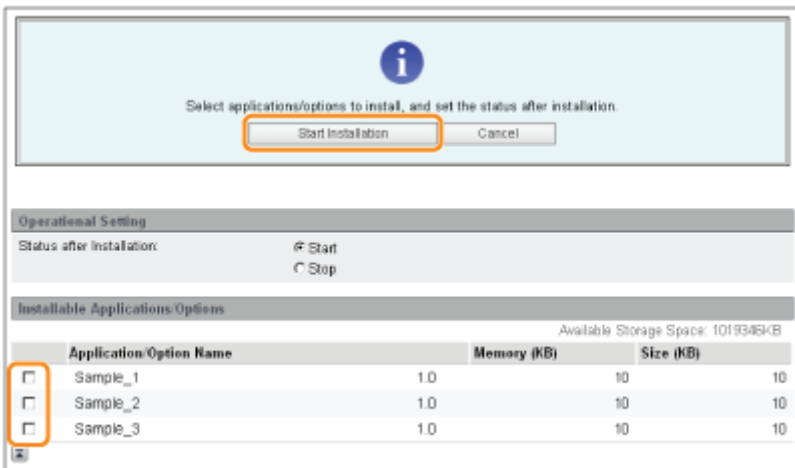

Status after Installation:

Start: Starts the installed MEAP applications.

Stop: Stops the installed MEAP applications.

IMPORTANT

If [Stop] is selected when installing MEAP applications

You need to start the application before using the MEAP application.

➤ ["Starting/Stopping MEAP Applications"](#)

If the agreement screen is displayed, read the agreement. If you abide with the agreement, click [Accept].

6

Check the Installation Result page.

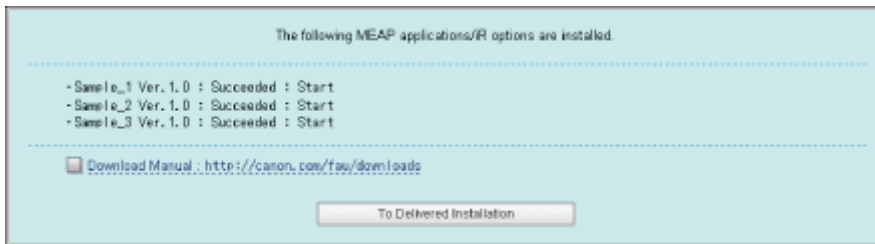

When the installation of the system options is completed, the message <Restart the device.> appears. Restart the printer to enable the function.

To return to the Delivered Installation screen, click [To Delivered Installation].

NOTE

The manual for system options/MEAP applications

You can download the manual for the installed system options/MEAP applications by accessing the URL for the manual download site displayed on the Installation Result screen.

➤ ["Downloading the Manuals and Related Software"](#)

Installing by Not Connecting This Printer to an Outside Network (Manual)

04L9-0CR

This section describes how to install the system options and MEAP applications without connecting the printer to an outside network.

Obtaining the License File

Obtain the license file.

License file: Obtain the license file when installing the system options/MEAP applications using the Remote UI.

NOTE

Preparing a license access number certificate

Make sure that the license access number that is included with the package is available.

License access number is not printed on the package of the MEAP application

If the license access number is not printed on the package of the MEAP application you are using, the license file is issued by the distributor of the MEAP application. You do not need to obtain the license file explained in this section. For more information, see the manual for each MEAP application.

1

Check the management number you need to obtain the license file.

To obtain the license file, the following management number is required.

- License Access Number: Check the license access number certificate.
 - Device Serial Number: You can check from the control panel.
- "[Utility Menu] Menu"

2

Access <http://www.canon.com/lms/license/>.

3

Follow the instructions on the screen and obtain the license file.

Next, install the system options or the MEAP applications.

Installing the System Options Using the Remote UI

You can install the system options to the printer using the Remote UI.

1

Start the Remote UI, and then log in as Administrator.

- "Starting the Remote UI"

2

From the top page of the Remote UI, click **[Settings/Registration]** → **[License/Other]** → **[Register/Update Software]**.

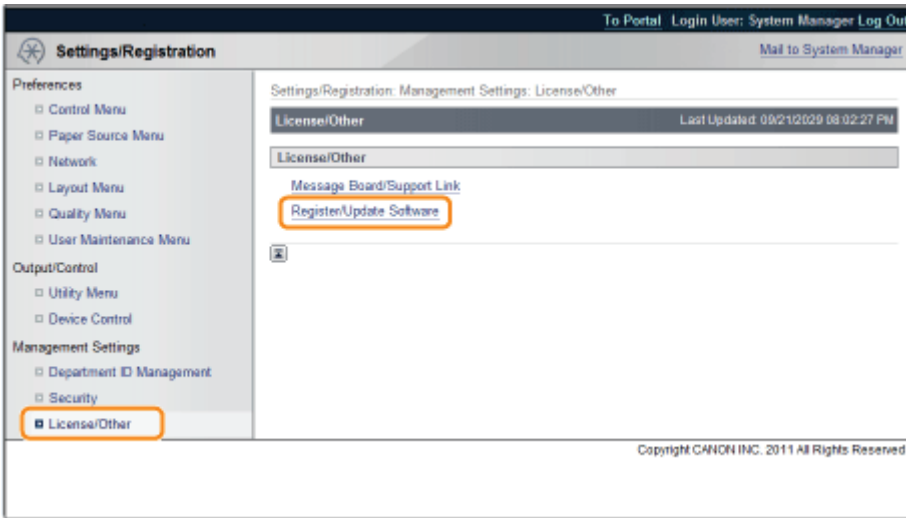

3

Click **[Manual Installation]**.

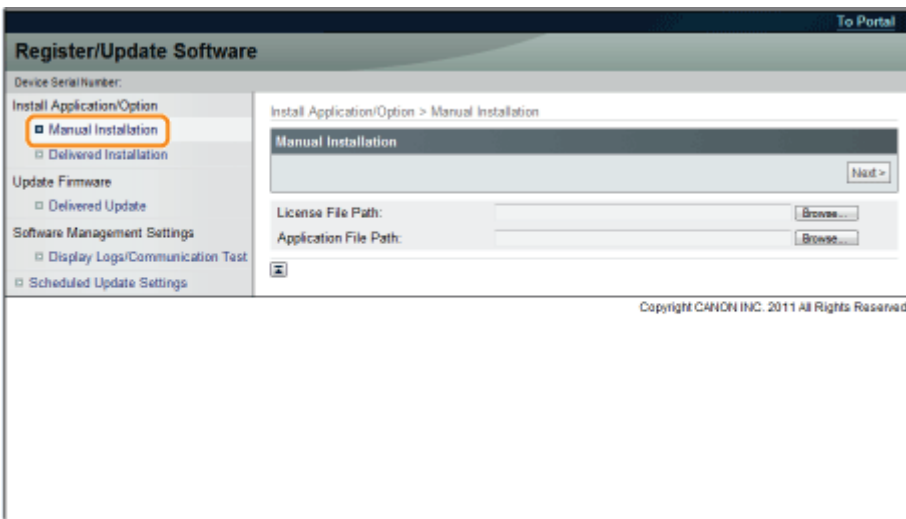

4

Click **[Browse...]** → select the license file to install → click **[Next]**.

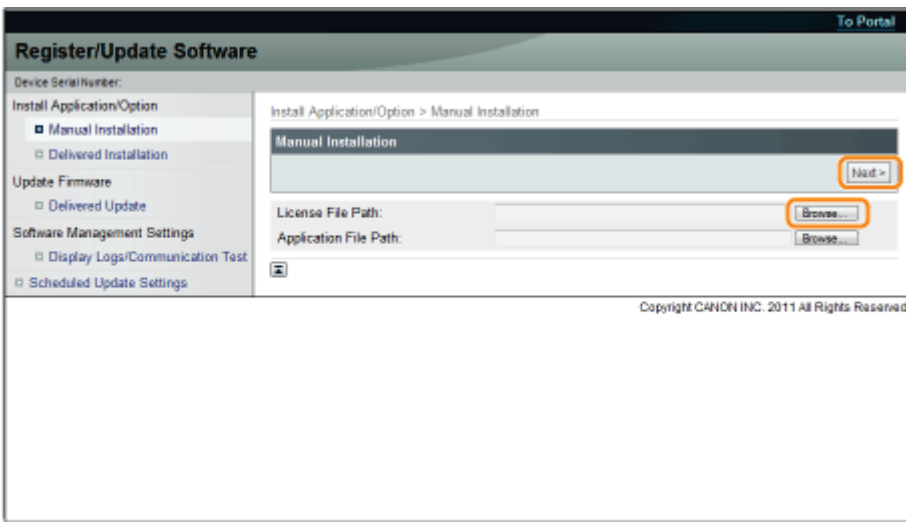

File extensions:

License File: A file with the [lic] extension.

5

Check the contents that will be installed on the confirmation screen → click [Install].

Installing the MEAP Applications Using the Remote UI

You can install the MEAP applications to the printer using the Remote UI.

NOTE

The number of MEAP applications that can be installed

You can install up to eight applications.

Memory area that can be used

The maximum amount of memory allocated to install MEAP applications is 32MB.

For details on MEAP applications

There may be other system requirements for installation, depending on the MEAP applications. For instructions on settings, see the manual provided with the MEAP application.

1

Start the Remote UI, and then log in as Administrator.

 "Starting the Remote UI"

2

From the top page of the Remote UI, click [Settings/Registration] → [License/Other] → [Register/Update Software].

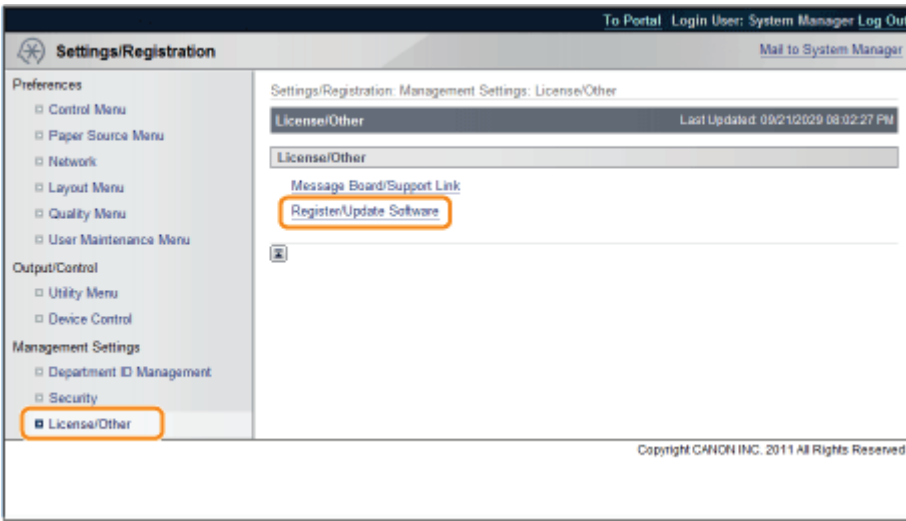

3

Click **[Manual Installation]**.

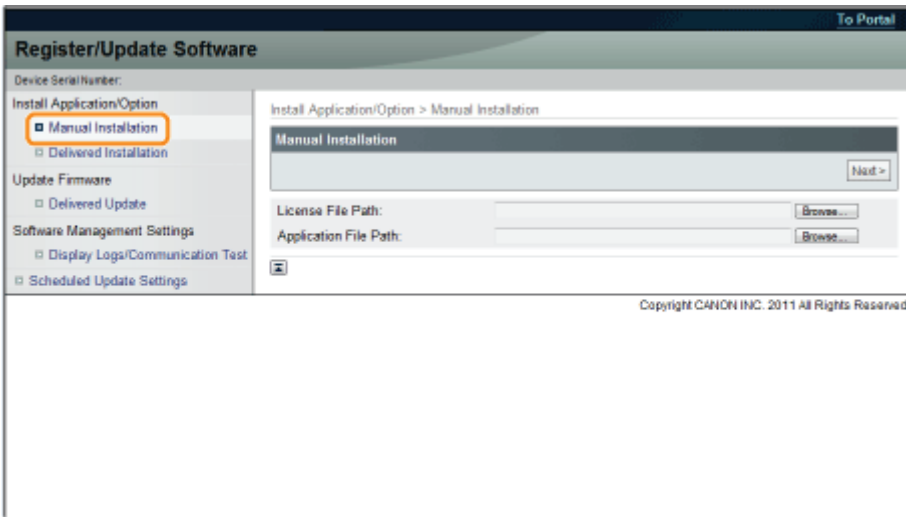

4

Click **[Browse...]** → select the license file and the application file to install → click **[Next]**.

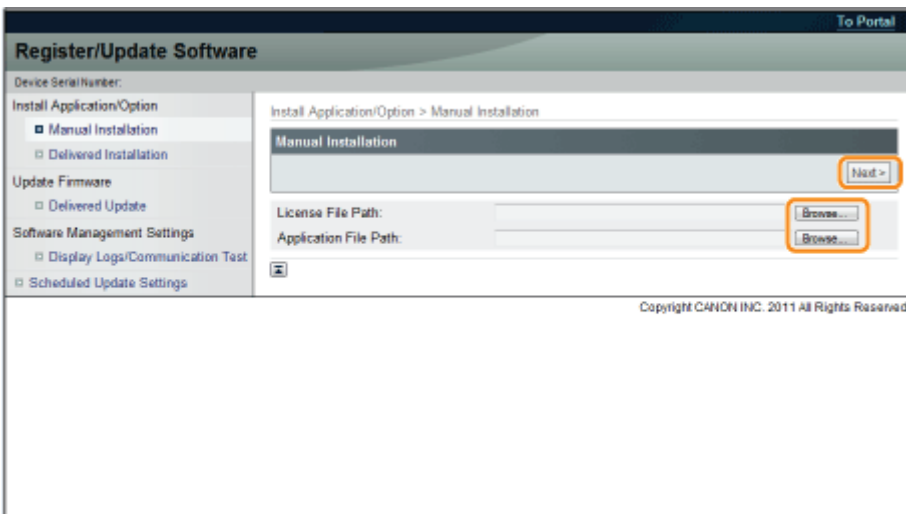

File extensions:

License File: A file with the [lic] extension.

Application File: A file with the [jar] extension.

IMPORTANT

When you install MEAP applications

- You cannot install license files only.
- When installing the MEAP application, make sure you specify the license file. You cannot install the MEAP application without specifying the license file.

5

Confirm the information displayed on the install confirmation page → click [Yes].

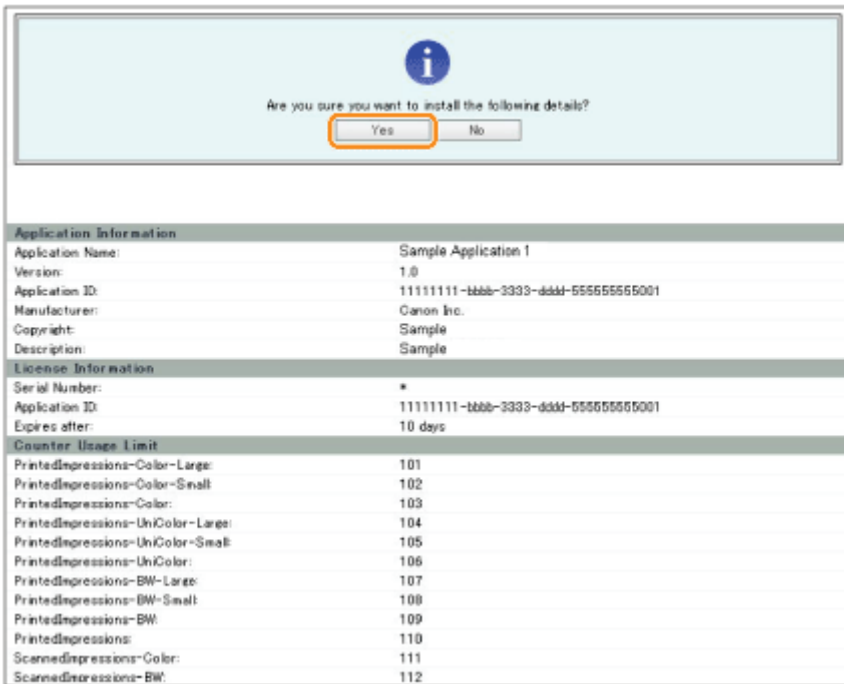

Are you sure you want to install the following details?

Application Information	
Application Name:	Sample Application 1
Version:	1.0
Application ID:	11111111-bbbb-3333-dddd-55555555001
Manufacturer:	Canon Inc.
Copyright:	Sample
Description:	Sample
License Information	
Serial Number:	*
Application ID:	11111111-bbbb-3333-dddd-55555555001
Expires after:	10 days
Counter Usage Limit	
PrintedImpressions-Color-Large:	101
PrintedImpressions-Color-Small:	102
PrintedImpressions-Color:	103
PrintedImpressions-UniColor-Large:	104
PrintedImpressions-UniColor-Small:	105
PrintedImpressions-UniColor:	106
PrintedImpressions-BW-Large:	107
PrintedImpressions-BW-Small:	108
PrintedImpressions-BW:	109
PrintedImpressions:	110
ScannedImpressions-Color:	111
ScannedImpressions-BW:	112

Depending on the MEAP application, a software license agreement screen may be displayed. Confirm the information displayed on the screen → click [OK].

If you are installing a new MEAP application, the following information is displayed on the screen.

- Application Information
- License Information

The following information is displayed when you overwrite a MEAP application.

- Current Application Information
- Application Information after Overwrite

Installation will start after the message <Installing... Please wait.> is displayed again. After the installation, click [To Manual Installation] to display the Manual Installation screen.

IMPORTANT

To use MEAP applications

To use the installed MEAP application, you must start the MEAP application.

- ["Starting/Stopping MEAP Applications"](#)

Starting the MEAP Applications

This section describes how to start the installed MEAP application from the SMS screen.

NOTE

Details on SMS

For details on SMS, see "MEAP (LBP6680x Only)."

1

From the top page of the SMS, click [MEAP Application Management].

Service Management Service

Device Serial Number: [REDACTED]

MEAP Application Management

Install MEAP Application

System Management

- Enhanced System Application Management
- System Application Management
- System Information
- MEAP Application Information
- Check License
- Change Password

MEAP Application Management

Updated On: Jan'16/2009 01:06:11

Application Name	Installed on	Status	Start	Uninstall	License
Sample Application 1	1.0.0.1 Jan'16/2009	Installed	Start	Uninstall	Unnecessary
Sample Application 2	1.0 Jan'16/2009	Installed	Start	Uninstall	Installed
Sample Application 3	0.6.1 Jan'14/2009	Started	Stop	Uninstall	Not Installed

Resource Information

Resource Name	Amount Used	Remaining	Percent Used
Storage	31102 KB	1017474 KB	3%
Memory	11746 KB	21022 KB	36%
Threads	36	220	14%
Sockets	34	222	13%
File Descriptor	9	247	4%

meap POWERED BY I

Version 3.0.1.1 Copyright CANON INC. 2009 All Rights Reserved.

2

Select the application you want to start → click [Start].

Service Management Service

Device Serial Number: [REDACTED]

MEAP Application Management

Install MEAP Application

System Management

- Enhanced System Application Management
- System Application Management
- System Information
- MEAP Application Information
- Check License
- Change Password

MEAP Application Management

Updated On: Jan'16/2009 01:06:11

Application Name	Installed on	Status	Start	Uninstall	License
Sample Application 1	1.0.0.1 Jan'16/2009	Installed	Start	Uninstall	Unnecessary
Sample Application 2	1.0 Jan'16/2009	Installed	Start	Uninstall	Installed
Sample Application 3	0.6.1 Jan'14/2009	Started	Stop	Uninstall	Not Installed

Resource Information

Resource Name	Amount Used	Remaining	Percent Used
Storage	31102 KB	1017474 KB	3%
Memory	11746 KB	21022 KB	36%
Threads	36	220	14%
Sockets	34	222	13%
File Descriptor	9	247	4%

meap POWERED BY I

Version 3.0.1.1 Copyright CANON INC. 2009 All Rights Reserved.

Downloading the Manuals and Related Software

04L9-0CS

You can download the manuals for the installed system options/MEAP applications and their related software from the following URL.

<http://canon.com/fau/downloads>

NOTE

- Make sure that the license access number that is included with the package is available.
- If you installed from the Remote UI, you can jump to the above URL from the link displayed on the Installation Result screen. If you do so, the license access number is entered automatically.

1

Start the Web browser on your computer.

2

Enter the URL in [Address].

3

After entering the license access number, follow the instructions on the screen to download the manuals and related software.

If software is downloaded, refer to the manual of that software to install.

Updating the Firmware

04L9-0CU

Update from the Remote UI.

NOTE

Communication test

To check that the transmission with the delivery server is properly operating, if necessary, perform a communication test before installation.

➤ ["Testing Communication Using the Remote UI"](#)

Updating by Connecting This Printer to an Outside Network

If the printer is connected to an outside network, you can update to a most recent firmware by linking with the delivery server.

IMPORTANT

Estimated time required to apply firmware

The time required to apply the downloaded firmware is approximately 20 minutes. This operation may take more time depending on the system configuration and network environment of your printer.

Checking the New Firmware/Specifying the Delivery Settings

You can check the new firmware that is applicable with the printer and specify the delivery settings.

1

Start the Remote UI, and then log in as Administrator.

➤ ["Starting the Remote UI"](#)

2

From the top page of the Remote UI, click [Settings/Registration] → [License/Other] → [Register/Update Software].

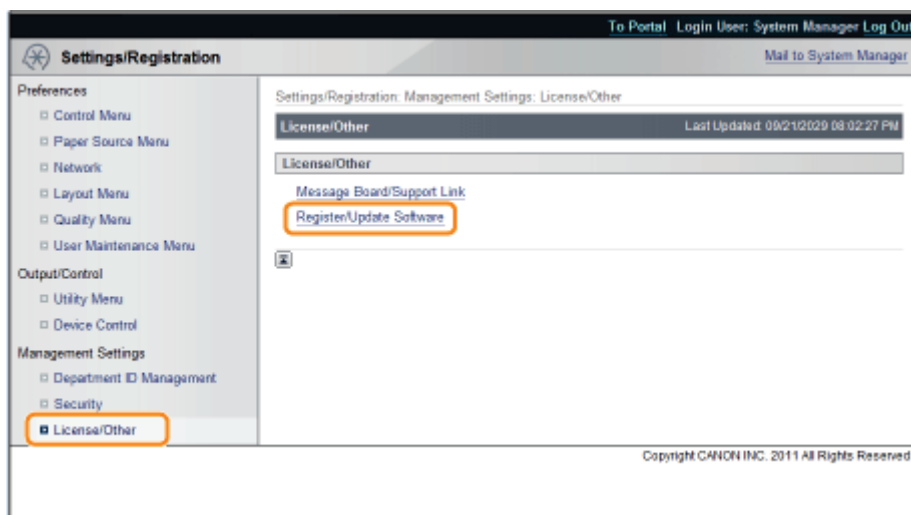

3

Click [Delivered Update].

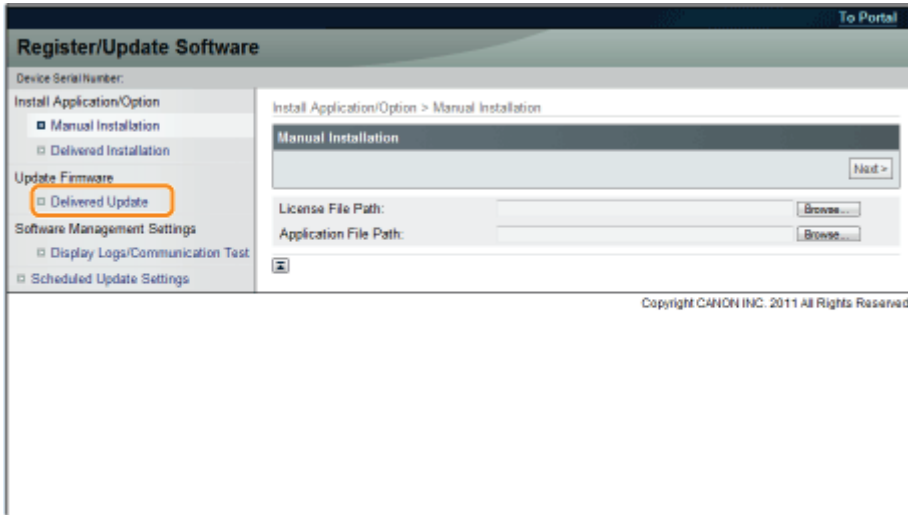

4

Click [Confirm New Firmware].

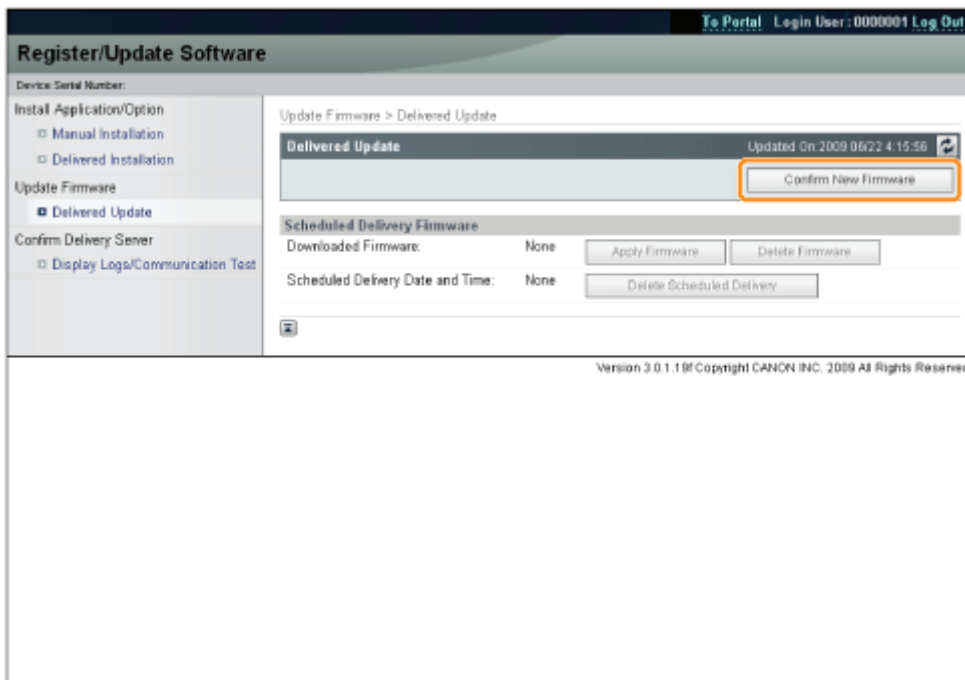

Contact the delivery server for information on whether an applicable new firmware is available or not.



5

Verify the displayed information → specify necessary settings → click [Execute].

If the agreement screen is displayed, read the agreement. If you abide with the agreement, press [I Accept].

Delivery Schedule and Timing to Apply

- When the Delivery Schedule is set to [Deliver now] and the Timing to Apply is set to [Auto]
The firmware is applied after the new firmware is downloaded from the delivery server. When the application is completed, the printer automatically restarts.

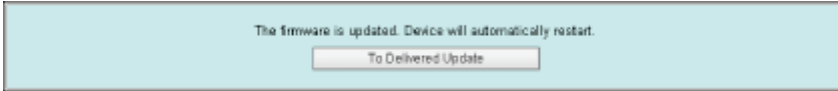

- When the Delivery Schedule is set to [Deliver now] and the Timing to Apply is set to [Manual]
The new firmware is downloaded.



- When the Delivery Schedule is set to [Deliver at specified date and time]
The scheduled delivery is set to the specified date/time.

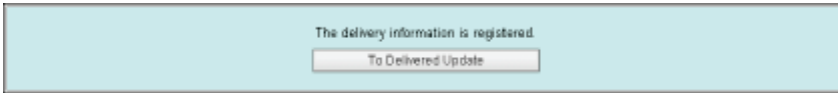

Applying the Downloaded Firmware

You can apply the downloaded firmware to the printer.

NOTE

If the Timing to Apply in Delivery Settings is set to [Auto], this step is not necessary.

1

Start the Remote UI, and then log in as Administrator.

 "Starting the Remote UI"

2

From the top page of the Remote UI, click [Settings/Registration] → [License/Other] → [Register/Update Software].

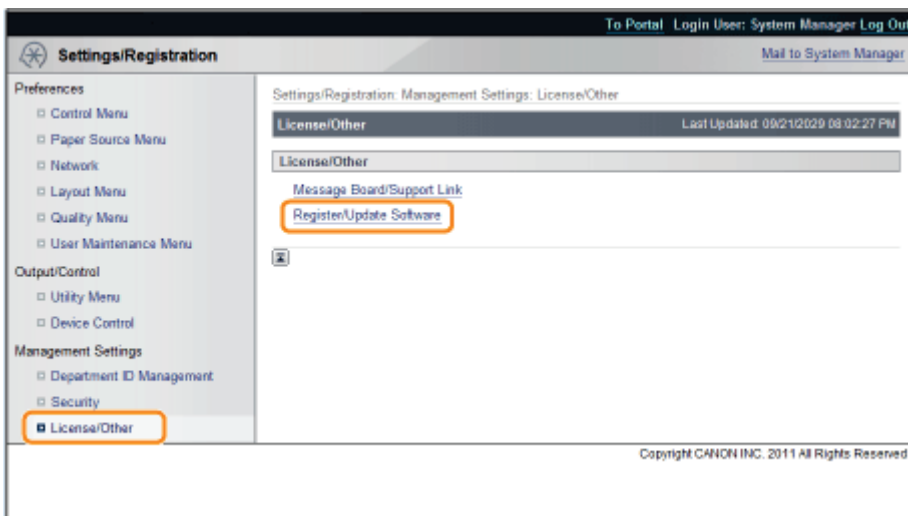

3

Click [Delivered Update].

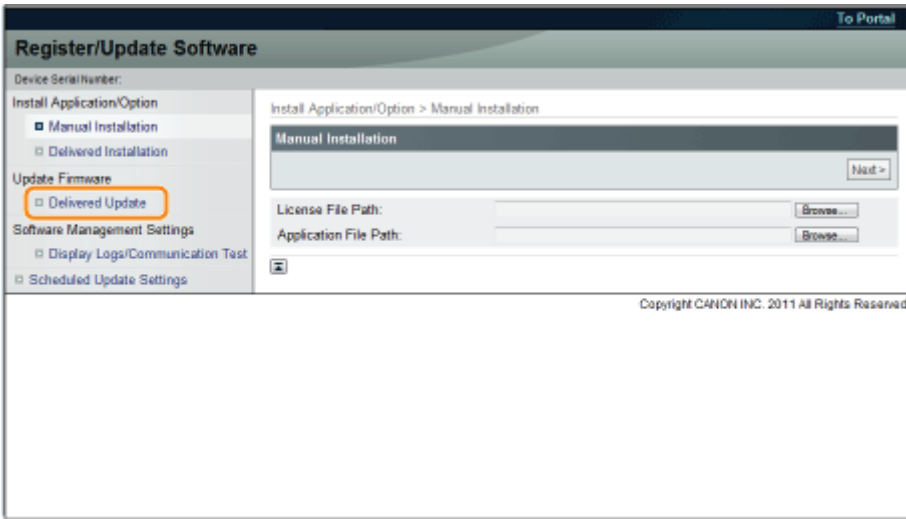

4

Click [Apply Firmware].

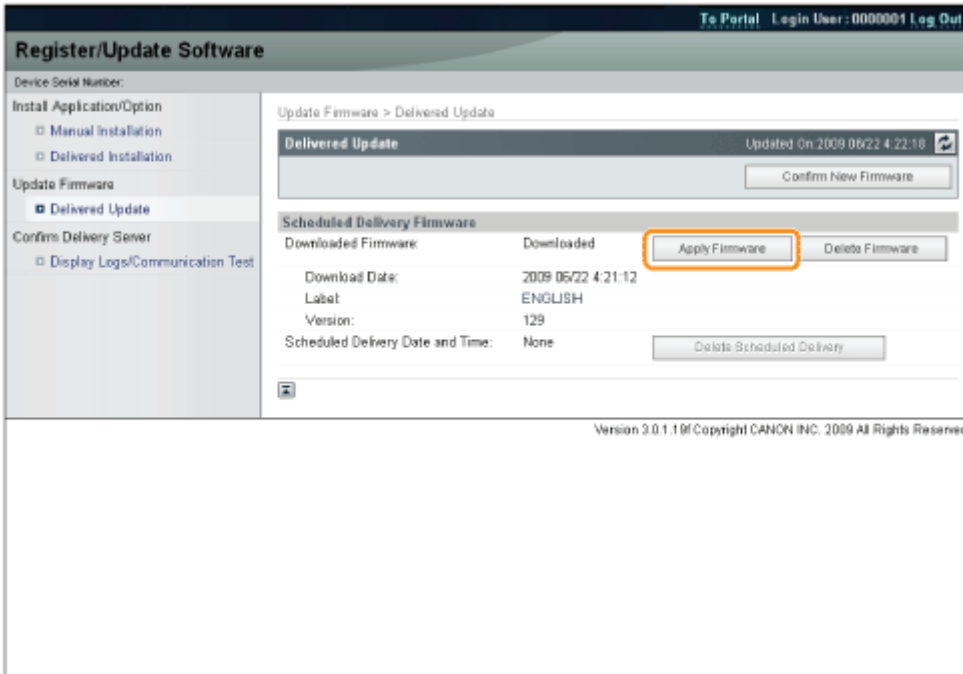

5

Confirm the firmware to apply → click [Yes].

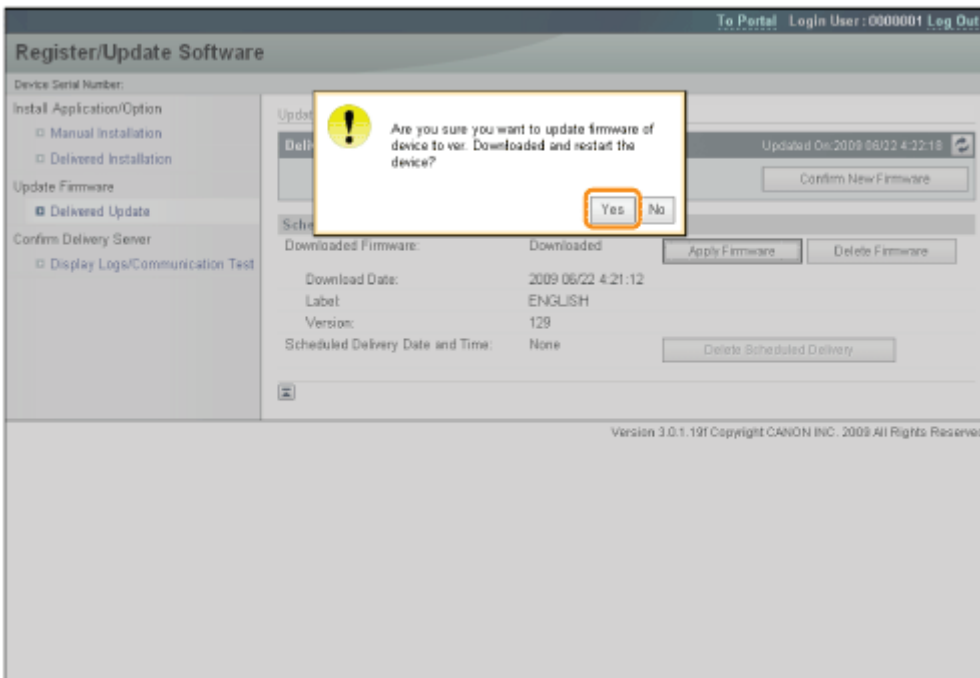

The new firmware is applied to the printer. When the application is completed, the printer automatically restarts.

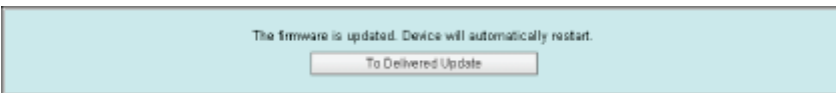

Deleting the Downloaded Firmware

You can delete the downloaded firmware.

1

Start the Remote UI, and then log in as Administrator.

❖ "Starting the Remote UI"

2

From the top page of the Remote UI, click [Settings/Registration] → [License/Other] → [Register/Update Software].

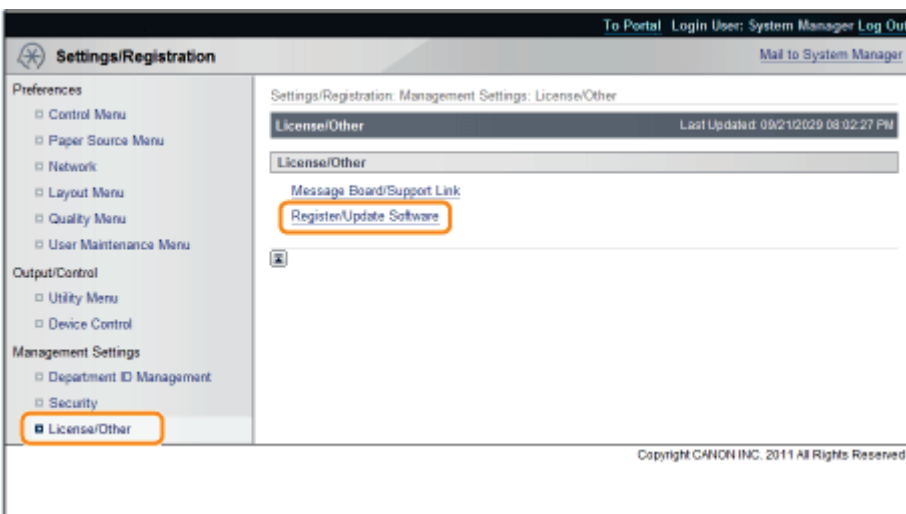

3

Click [Delivered Update].

The screenshot shows the 'Register/Update Software' web interface. On the left sidebar, under 'Update Firmware', the 'Delivered Update' option is selected and highlighted with an orange box. The main content area shows 'Manual Installation' with a 'Next >' button. Below that are fields for 'License File Path' and 'Application File Path', each with a 'Browse...' button. The footer contains the text 'Copyright CANON INC. 2011 All Rights Reserved'.

4

Click [Delete Firmware].

The screenshot shows the 'Register/Update Software' web interface. The left sidebar has 'Delivered Update' selected. The main content area shows 'Update Firmware > Delivered Update'. There is a 'Delivered Update' section with a 'Confirm New Firmware' button. Below it is the 'Scheduled Delivery Firmware' section, which contains a table of firmware details. In this table, the 'Delete Firmware' button is highlighted with an orange box. The footer contains the text 'Version 3.0.1.19 Copyright CANON INC. 2009 All Rights Reserved'.

Downloaded Firmware:	Downloaded	Apply Firmware	Delete Firmware
Download Date:	2009 05/22 4:21:12		
Label:	ENGLISH		
Version:	129		
Scheduled Delivery Date and Time:	None	Delete Scheduled Delivery	

5

Confirm the firmware to delete → click [Yes].

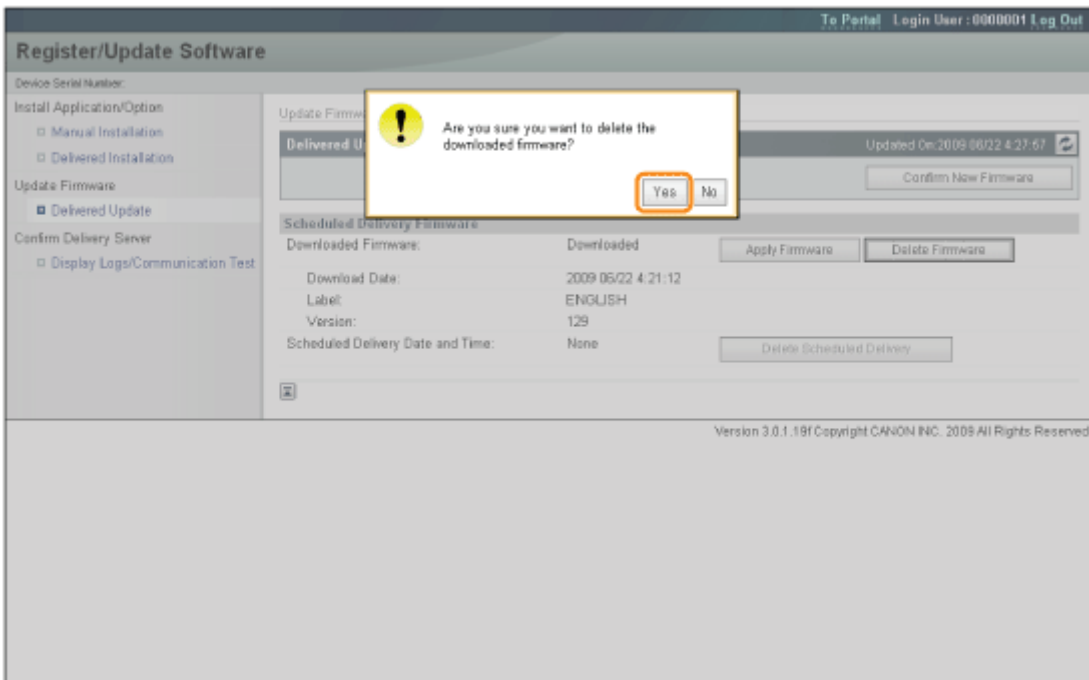

The firmware is deleted.



Deleting the Scheduled Delivery

You can delete the scheduled delivery of the firmware.

1

Start the Remote UI, and then log in as Administrator.

❖ "Starting the Remote UI"

2

From the top page of the Remote UI, click [Settings/Registration] → [License/Other] → [Register/Update Software].

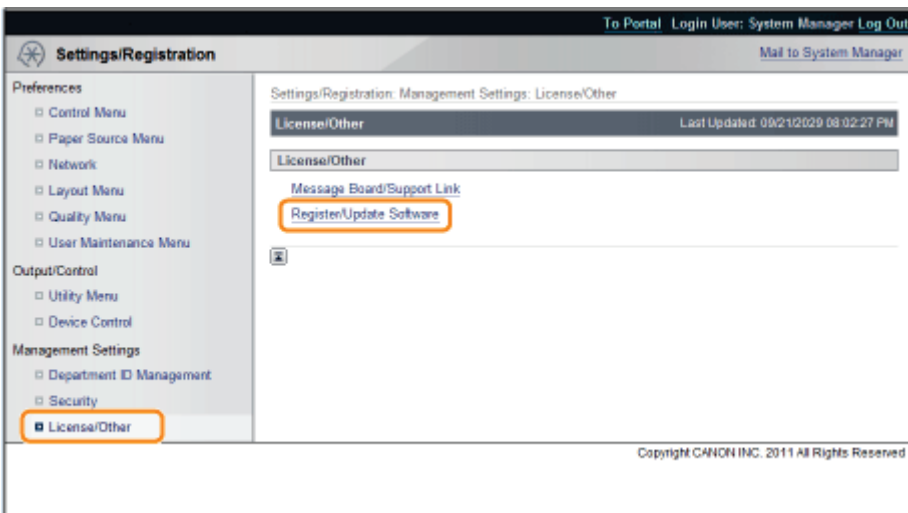

3

Click [Delivered Update].

Register/Update Software

Device Serial Number:

Install Application/Option

- Manual Installation
- Delivered Installation

Update Firmware

- Delivered Update**

Software Management Settings

- Display Logs/Communication Test
- Scheduled Update Settings

Install Application/Option > Manual Installation

Manual Installation

Next >

License File Path: Browse...

Application File Path: Browse...

Copyright CANON INC. 2011 All Rights Reserved

4

Click [Delete Scheduled Delivery].

Register/Update Software

Device Serial Number:

Install Application/Option

- Manual Installation
- Delivered Installation

Update Firmware

- Delivered Update**

Confirm Delivery Server

- Display Logs/Communication Test

Update Firmware > Delivered Update

Delivered Update

Updated On 2009 06/22 4:30:13

Confirm New Firmware

Scheduled Delivery Firmware

Downloaded Firmware:	None	Apply Firmware	Delete Firmware
Scheduled Delivery Date and Time:	2009 06/28 4:29:41	Delete Scheduled Delivery	
Label:	ENGLISH		
Version:	129		

Version 3.0.1.18f Copyright CANON INC. 2009 All Rights Reserved

5

Confirm the information of the scheduled delivery → click [Yes].

To Portal Login User : 0000001 Log Out

Register/Update Software

Device Serial Number:

- Install Application/Option
 - Manual Installation
 - Delivered Installation
- Update Firmware
 - Delivered Update**
- Confirm Delivery Server
 - Display Logs/Communication Test

Update Firmware

Delivered Update

Updated On: 2009 06/22 4:30:13

Confirm New Firmware

Scheduled Delivery Firmware

Downloaded Firmware:	None	Apply Firmware	Delete Firmware
Scheduled Delivery Date and Time:	2009 06/28 4:29:41	Delete Scheduled Delivery	
Label:	ENGLISH		
Version:	129		

Version 3.0.1.191 Copyright CANON INC. 2009 All Rights Reserved

The scheduled delivery is deleted.

The scheduled delivery was deleted.

To Delivered Update

Managing the Register/Update Software Function

04L9-0CW

You can display the installation logs and test communication using the Remote UI.

Displaying the Installation/Update Log Using the Remote UI

You can check the installation logs of the system options/MEAP applications and the update log of the firmware.

1

Start the Remote UI, and then log in as Administrator.

❖ "Starting the Remote UI"

2

From the top page of the Remote UI, click [Settings/Registration] → [License/Other] → [Register/Update Software].

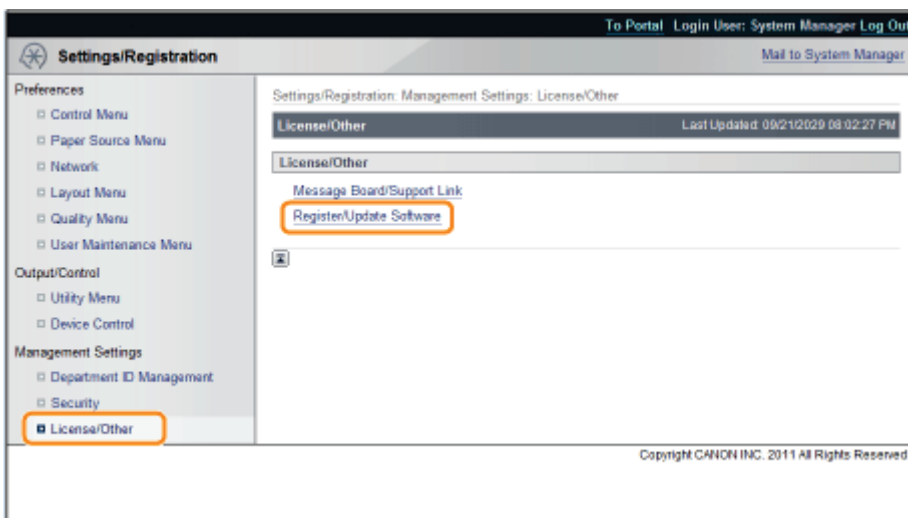

3

Click [Display Logs /Communication Test].

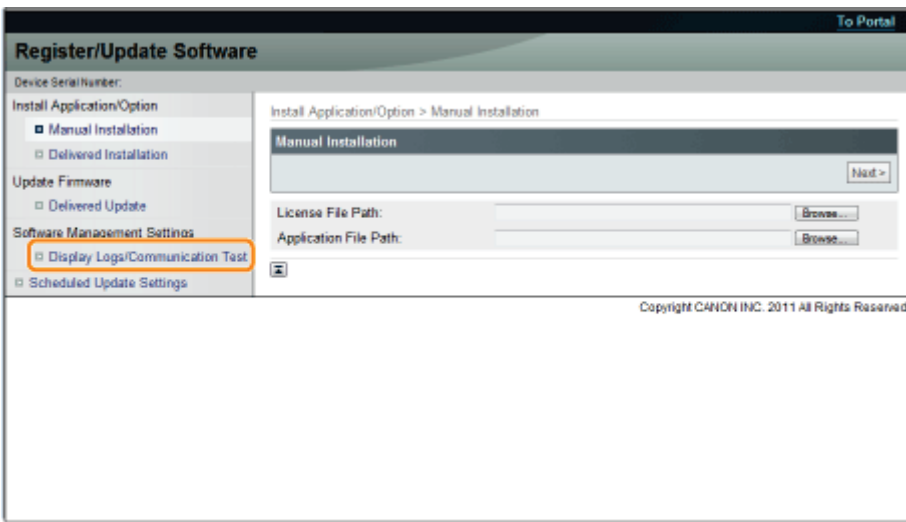

4

From the Log View drop-down list, select [Update Logs] → click [Switch].

The installation logs of the system options/MEAP applications and the update log of the firmware are displayed.

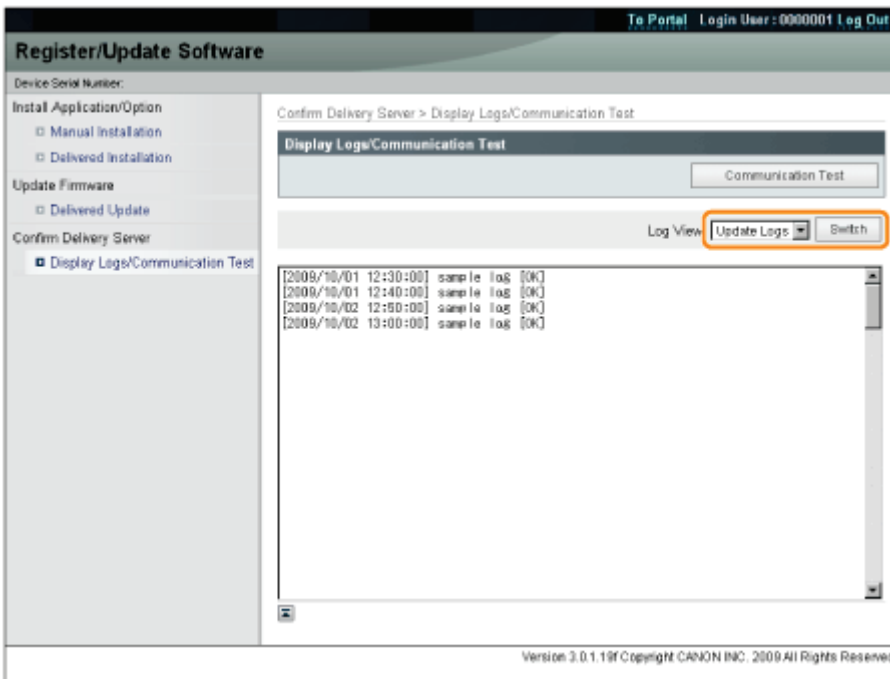

Testing Communication Using the Remote UI

You can check whether the printer can properly communicate with the delivery server.

1

Start the Remote UI, and then log in as Administrator.

➤ "Starting the Remote UI"

2

From the top page of the Remote UI, click [Settings/Registration] → [License/Other] → [Register/Update Software].

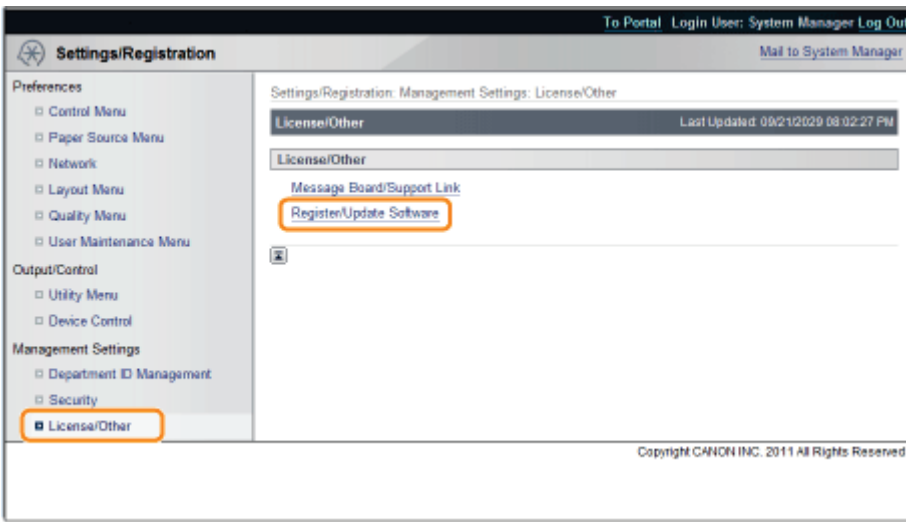

3

Click [Display Logs /Communication Test] → [Communication Test].

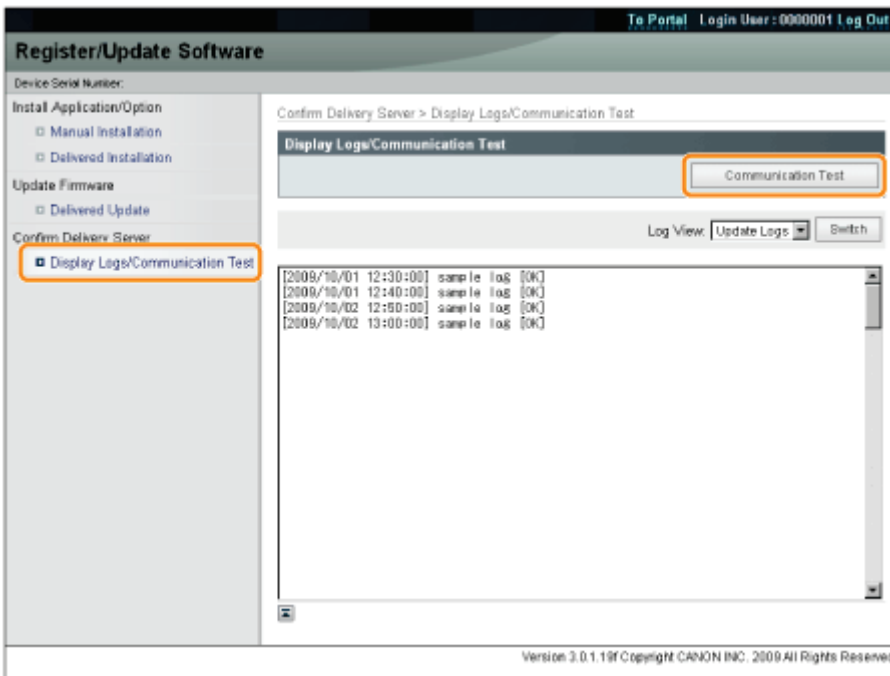

When the confirmation dialog is displayed, click [Yes].

Contents for the test are downloaded from the delivery server.

When the communication test is completed, the communication test result screen is displayed.

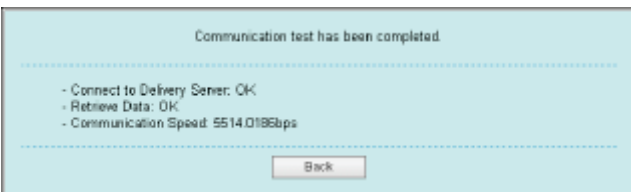

NOTE

If [Failed] is displayed on the communication test result

If [Failed] is displayed on the communication test result screen, check that the network cable is connected and that the network settings are correct. If the problem is not resolved, contact your local authorized Canon dealer.

Restricting the Users Who Can Print or Perform the Printer Settings

Restricting the Users Who Can Access

Setting Restrictions for Print Jobs

Specifying the Job Operation Permission for End-Users

Locking the Keys on the Control Panel (Key Lock Function)

Setting Restrictions for USB Direct Print (LBP6680x Only)

Setting Keys and Certificates

Setting CA Certificates

Setting the SSL Encryption Communication Function

Setting the IPsec Encryption Communication Function (LBP6680x Only)

Specifying the Setting for Job Log Display

NOTE

Software to be used for the security settings

You can specify the settings using the following software.

- **Remote UI**

You can specify the settings by accessing the printer from a Web browser via the network.

- **FTP Client**

You can specify the settings by accessing the FTP server of the printer using Command Prompt.

This section describes the procedure for specifying the settings using the Remote UI. To specify the settings using FTP Client, see "[FTP Client](#)."

Restricting the Users Who Can Print or Perform the Printer Settings

04L9-0CY

You can restrict the users who can print or perform the printer settings with IP addresses by using a Web browser (Remote UI).

- ❖ Restriction Using the IP v. 4 Address
- ❖ Restriction Using the IP v. 6 Address

Always use the Remote UI to specify the IP address. The control panel allows you only to switch the address filter setting between On and Off.

- ❖ [Setup] Menu ([Network] Options)

Restriction Using the IP v. 4 Address

1

Start the Remote UI, and then log in as Administrator.

- ❖ "Starting the Remote UI"

2

Click [Settings/Registration].

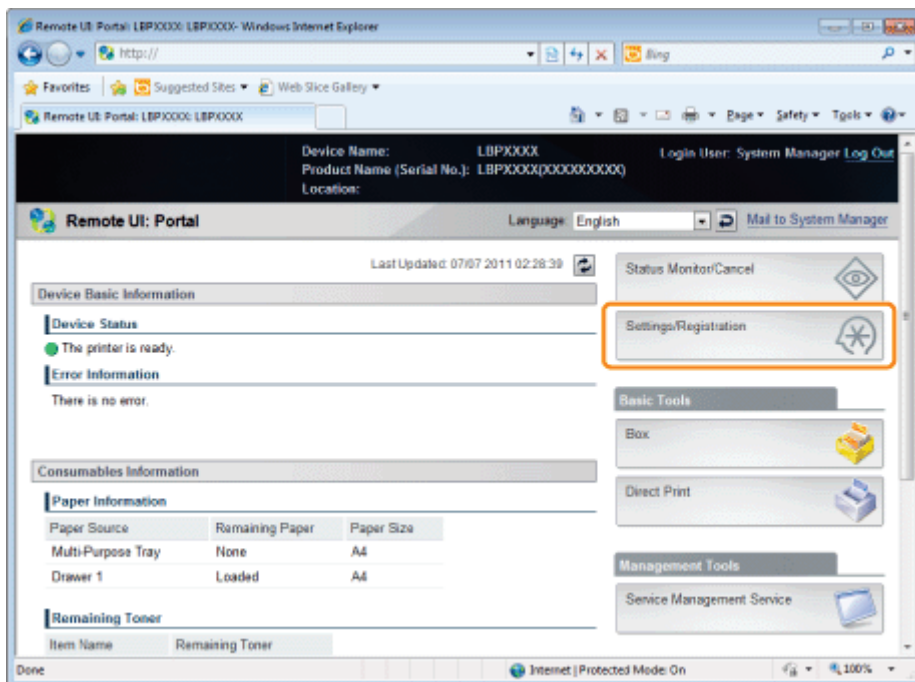

3

Select [Security] from the [Management Settings] menu.

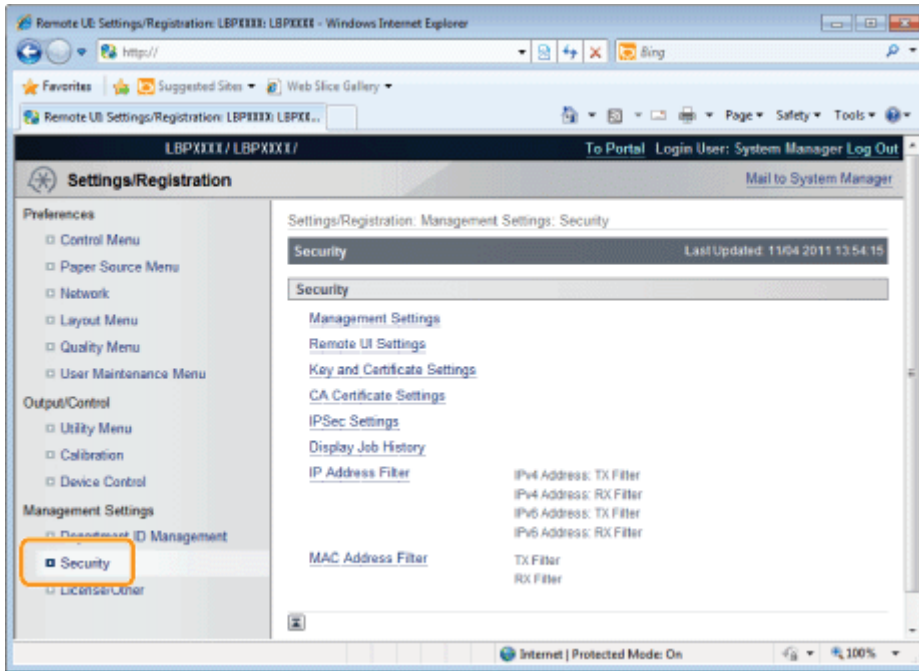

4

Click [IP Address Filter].

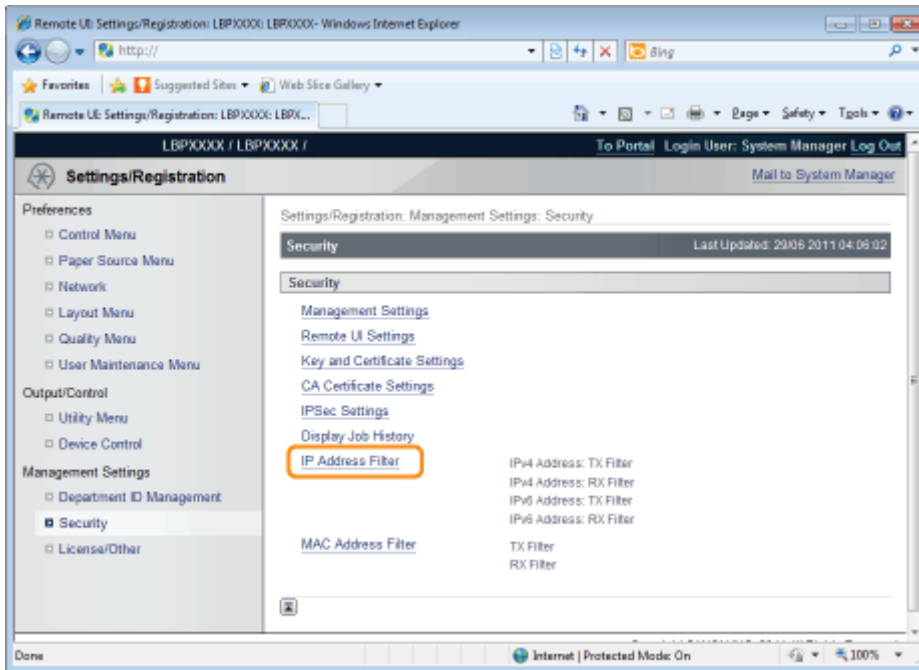

5

Click [Edit...] under [IPv4 Address: TX Filter] or [IPv4 Address: RX Filter].

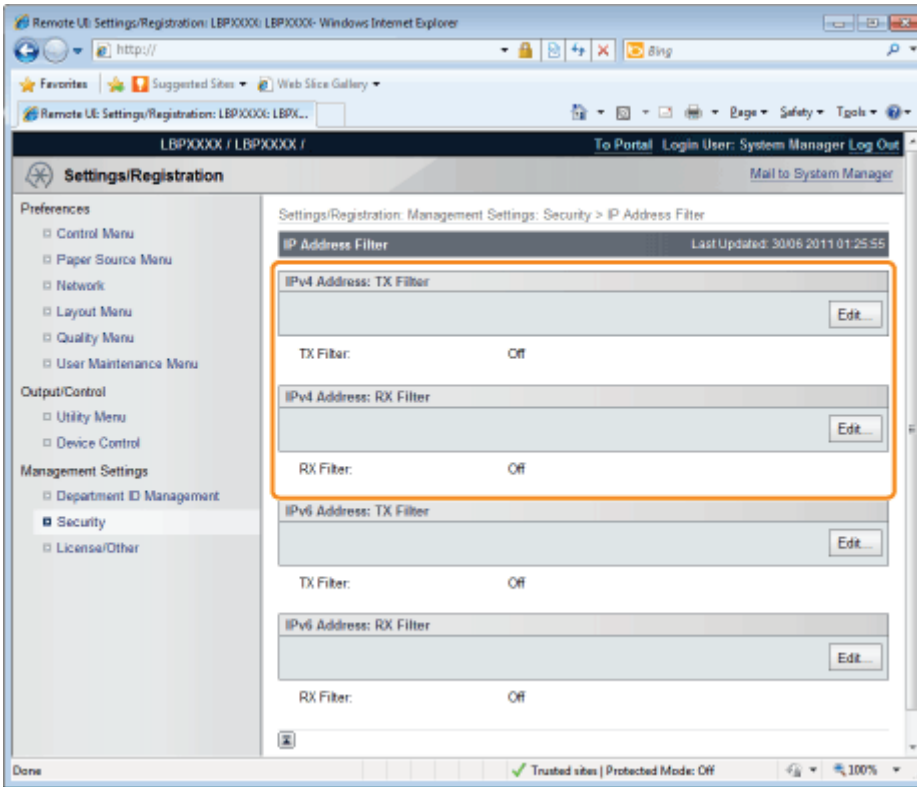

[IPv4 Address: TX Filter]	It limits the sending of data from the printer.
[IPv4 Address: RX Filter]	It limits the sending of data to the printer.

6

Select the [Use Filter] check box, and then [Default Policy].

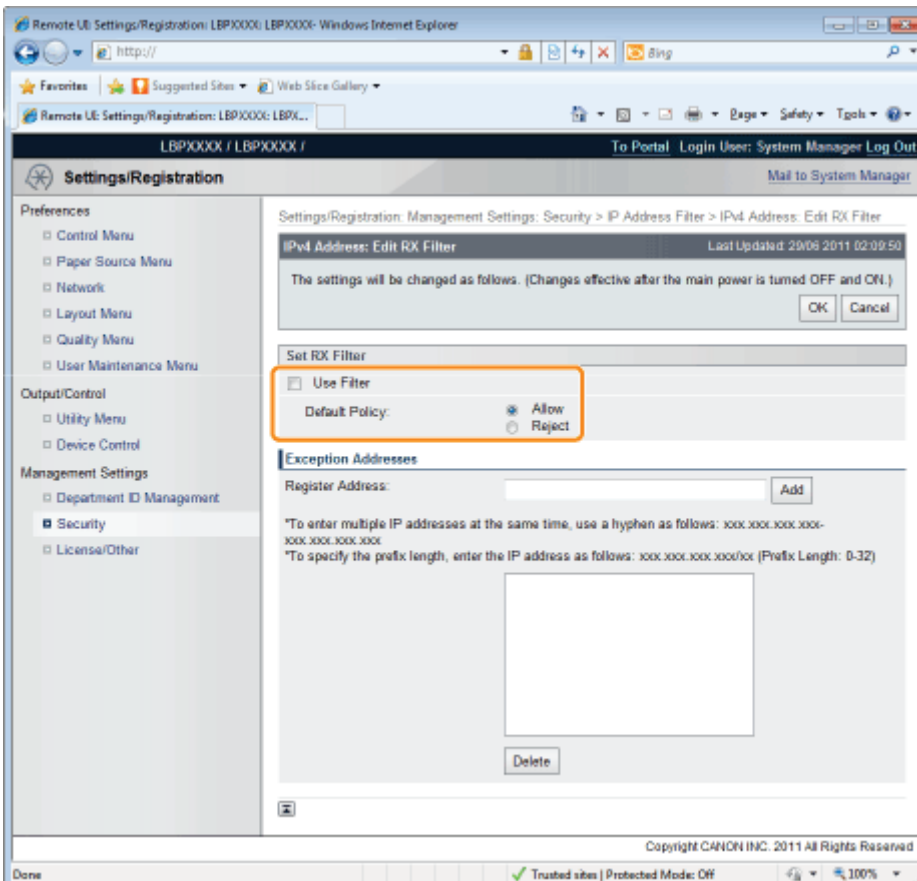

- If you select [Reject], you will only be able to transmit or print from users (clients) entered in the [Exception Addresses] field.
- If you select [Allow], you will not be able to transmit or print from users (clients) entered in the [Exception Addresses] field.
- If you clear the [Use Filter] check box, you will be able to transmit and print from all users (clients).

7

Set the IP address.

(1) Enter the IP address for which you want to reject or permit to print.

- † Enter the IPv4 address, which is a decimal value, by adding "." (periods) as delimiters.

(2) Click [Add].

- † You can set up to 16 IP addresses (16 sets of IP addresses for when you have specified with [Register Address]).

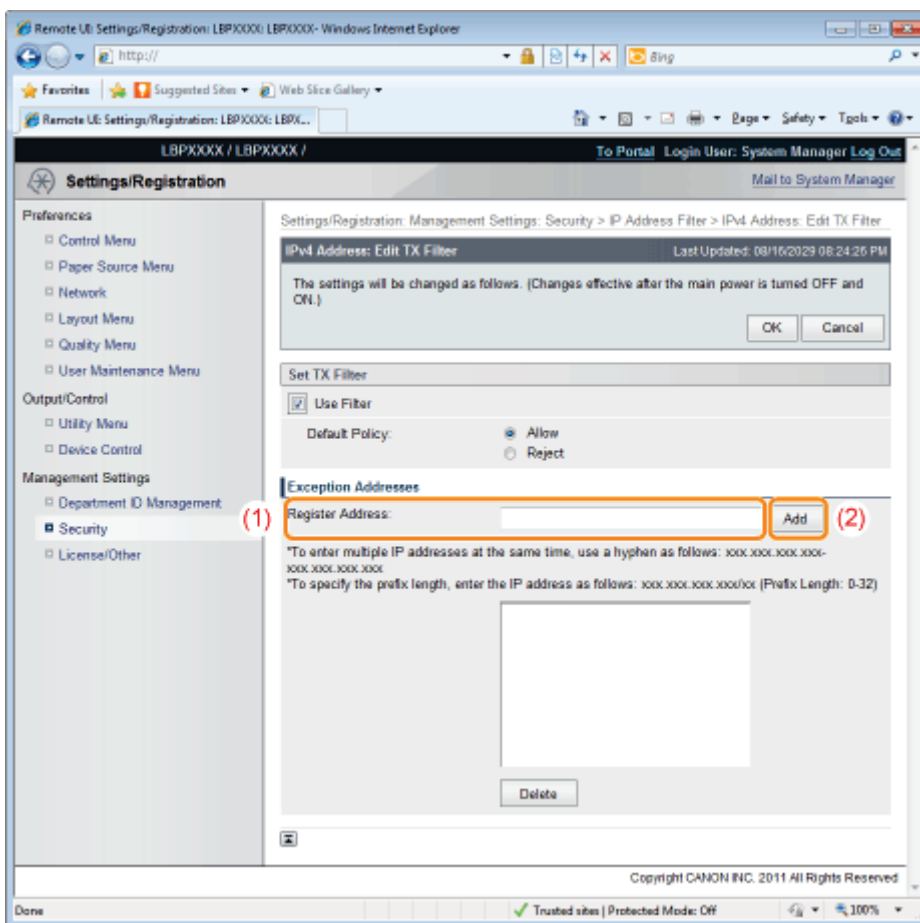

You can also enter IP addresses as follows.

Input example of the IP addresses	Method for entering IP addresses
192.168.0.1-192.168.0.10	If you want to enter the IP addresses of consecutive numbers, place "-" (hyphen) between the address of the smallest number and that of the largest number.
192.168.0.0/16	In order to specify the subnet range (prefix length), enter a "/" (slash) after the normal IP address symbol, and then enter another prefix length (maximum 32).

NOTE

When "0" is entered in [Prefix Length]

All the IP addresses become the target for rejection or permission.

When "32" is entered in [Prefix Length]

The IP address of the printer becomes the target for rejection or permission.

When deleting a set IP address

- (1) Select an IP address you want to delete.
- (2) Click [Delete].

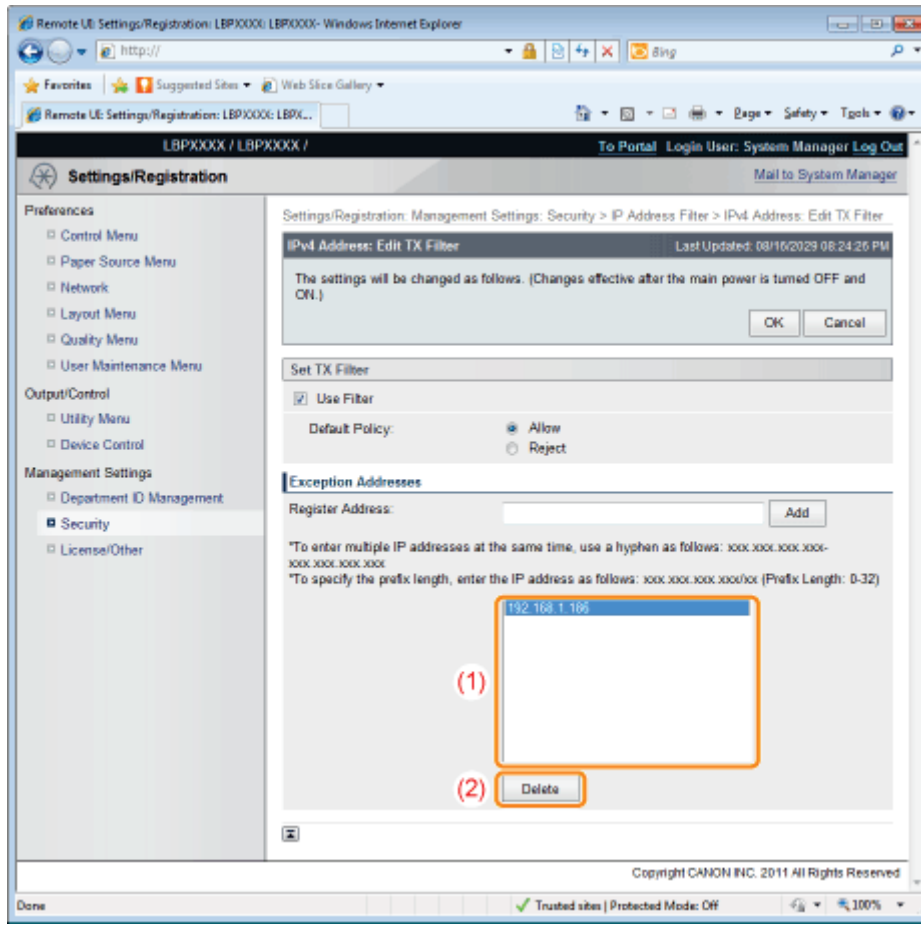

8

Click [OK].

9

Perform a hard reset or restart the printer.

→ After performing a hard reset or restarting the printer, the settings are effective.

NOTE

To perform a hard reset

You can perform a hard reset using the following procedure.

1. Click [Settings/Registration].
2. Select [Device Control] from the [Output/Control] menu.
3. Select [Hard Reset], and then click [Execute].

Restriction Using the IP v. 6 Address

1

Start the Remote UI, and then log in as Administrator.

➤ "Starting the Remote UI"

2

Click [Settings/Registration].

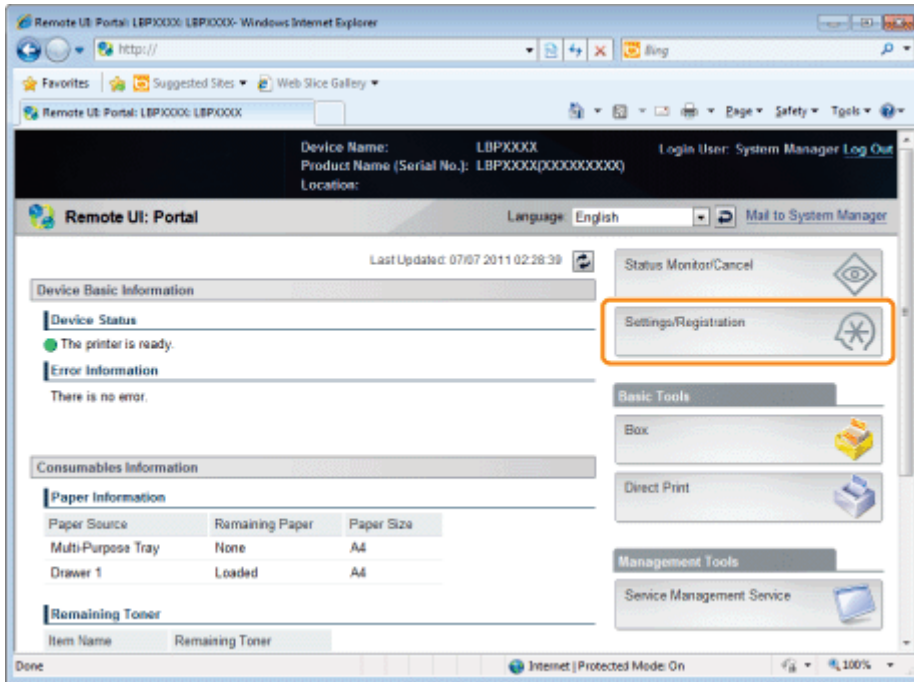

3

Select [Security] from the [Management Settings] menu.

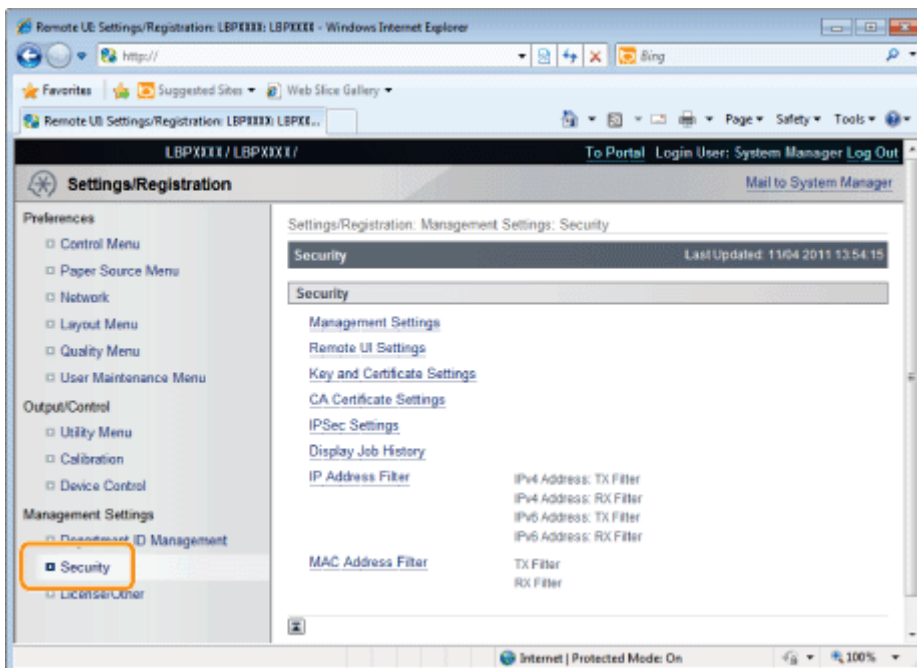

4

Click [IP Address Filter].

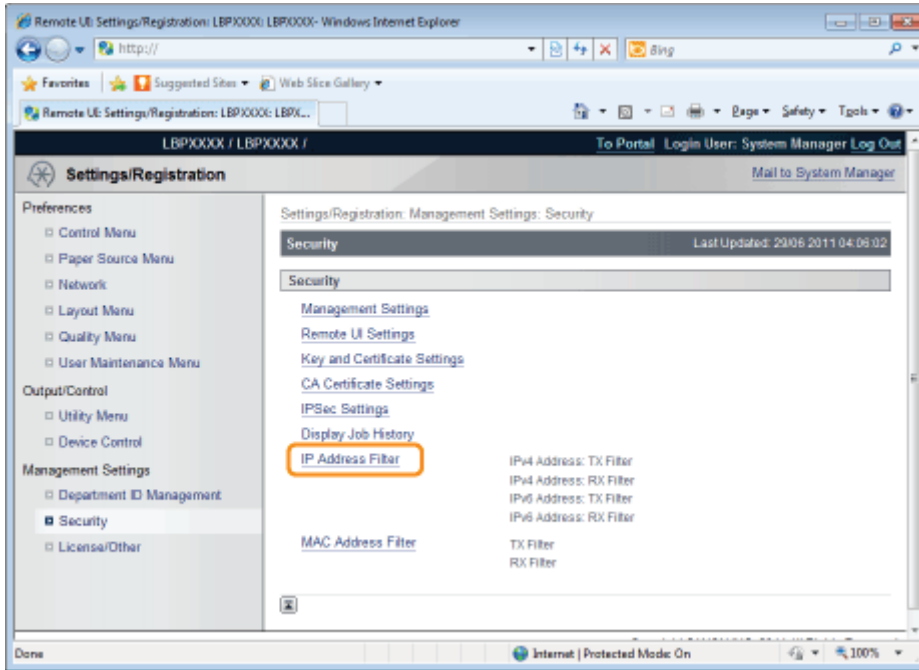

5

Click [Edit...] under [IPv6 Address: TX Filter] or [IPv6 Address: RX Filter].

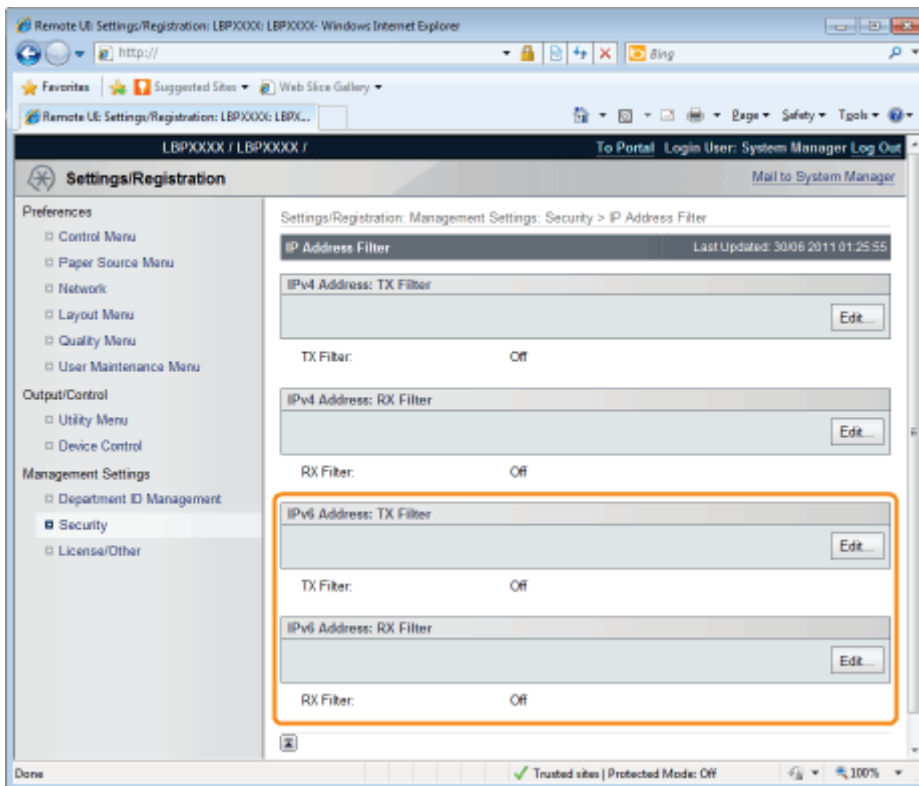

[IPv6 Address: TX Filter]	It limits the sending of data from the printer.
[IPv6 Address: RX Filter]	It limits the sending of data to the printer.

6

Select the [Use Filter] check box, and then select [Default Policy].

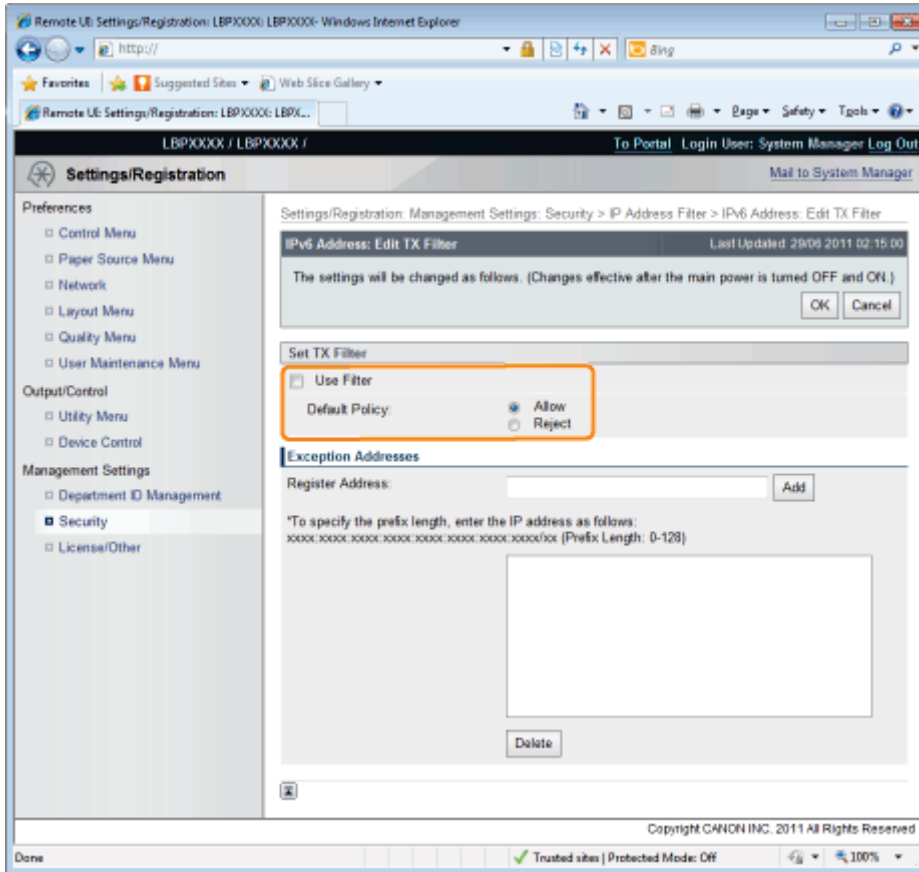

- If you select [Reject], you will only be able to transmit or print from users (clients) entered in the [Exception Addresses] field.
- If you select [Allow], you will not be able to transmit or print from users (clients) entered in the [Exception Addresses] field.
- If you clear the [Use Filter] check box, you will be able to transmit and print from all users (clients).

7

Set the IP address.

(1) Enter the IP address for which you want to reject or permit to print.

† Enter the IPv6 address, which is a hexadecimal value, by adding ":" (colons) as delimiters.

(2) Click [Add].

† You can set up to 16 IP addresses (16 sets of IP addresses for when you have specified with [Register Address]).

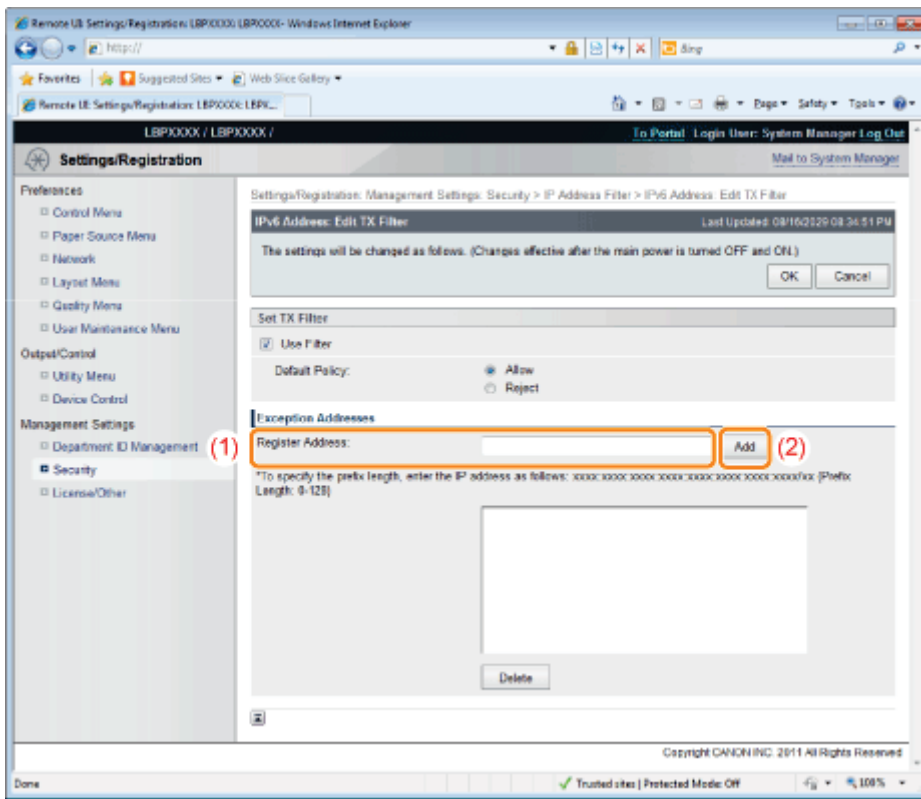

You can also enter IP addresses as follows.

Input example of the IP addresses	Method for entering IP addresses
fe80::0000/64	In order to specify the subnet range (prefix length), enter a "/" (slash) after the normal IP address symbol, and then enter another prefix length (maximum 128).

NOTE

When "0" is entered in [Prefix Length]

All the IP addresses become the target for rejection or permission.

When "128" is entered in [Prefix Length]

The IP address of the printer becomes the target for rejection or permission.

When deleting a set IP address

- (1) Select an IP address you want to delete.
- (2) Click [Delete].

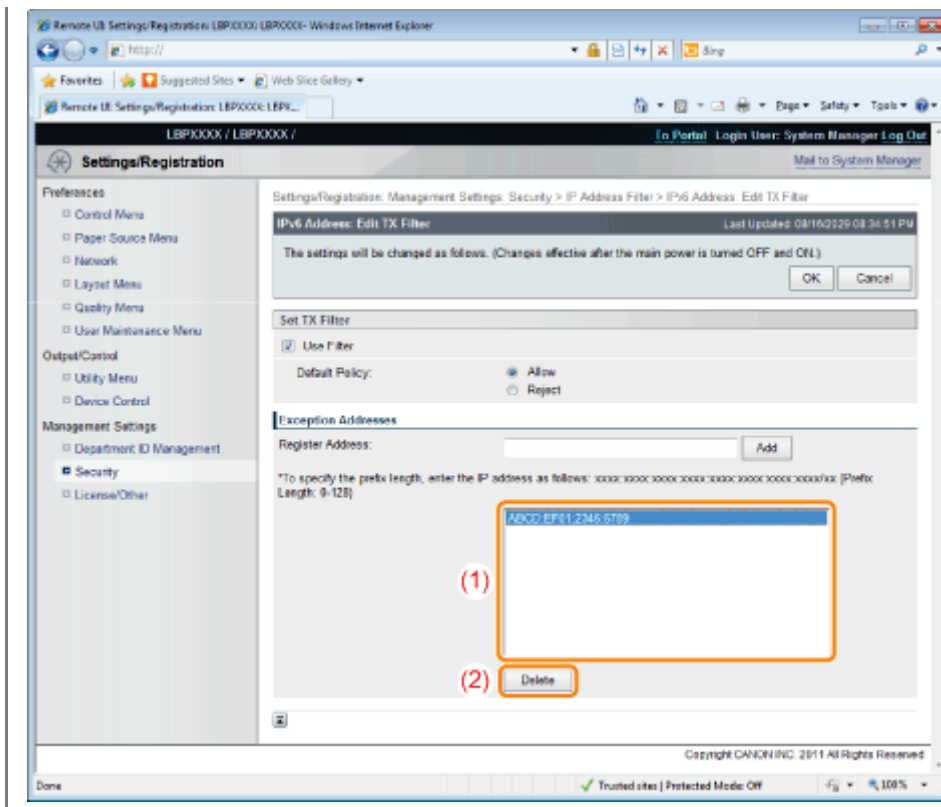

8

Click [OK].

9

Perform a hard reset or restart the printer.

→ After performing a hard reset or restarting the printer, the settings are effective.

NOTE

To perform a hard reset

You can perform a hard reset using the following procedure.

1. Click [Settings/Registration].
2. Select [Device Control] from the [Output/Control] menu.
3. Select [Hard Reset], and then click [Execute].

Restricting the Users Who Can Access

04L9-OE0

You can restrict the users who can access with MAC addresses using a Web browser (Remote UI).

Always use the Remote UI to specify the MAC address. The control panel allows you only to switch the address filter setting between On and Off.

- [Setup] Menu ([Network] Options)

1

Start the Remote UI, and then log in as Administrator.

- "Starting the Remote UI"

2

Click [Settings/Registration].

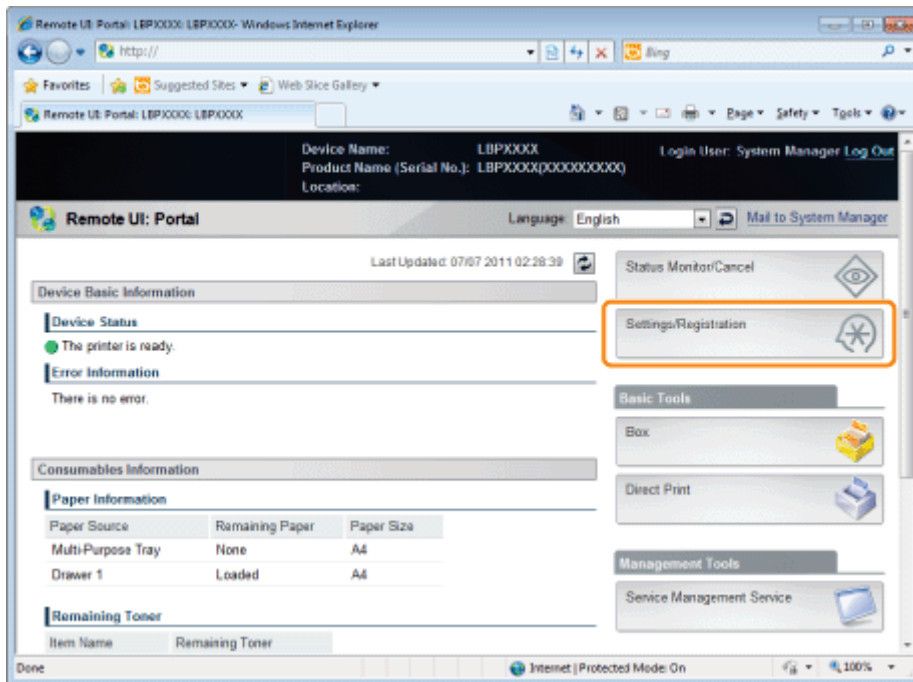

3

Select [Security] from the [Management Settings] menu.

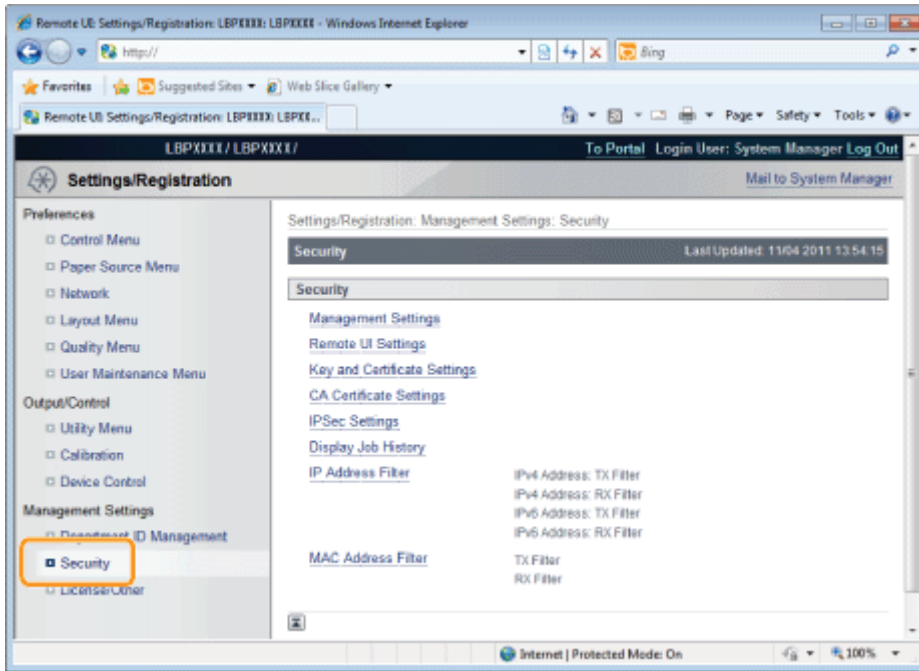

4

Click [MAC Address Filter].

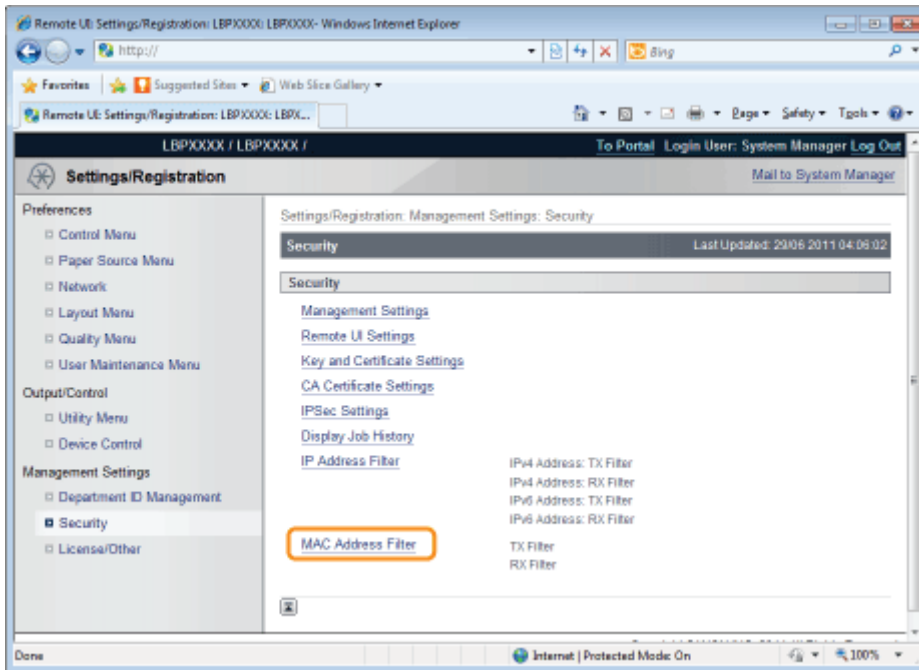

5

Click [Edit...] under [TX Filter] or [RX Filter].

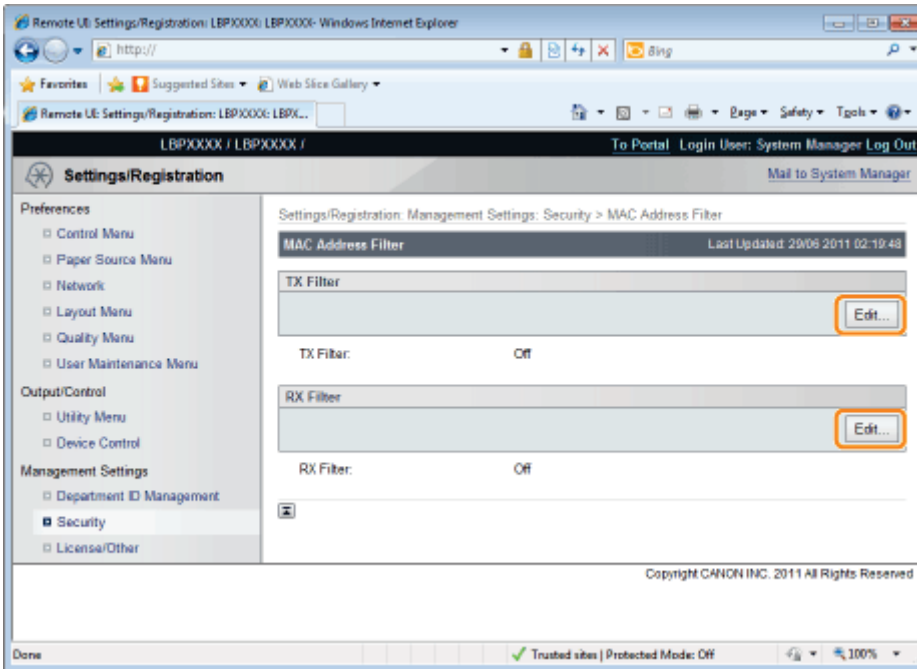

[TX Filter]	It limits the sending of data from the printer.
[RX Filter]	It limits the sending of data to the printer.

6

Select the [Use Filter] check box, and then select [Default Policy].

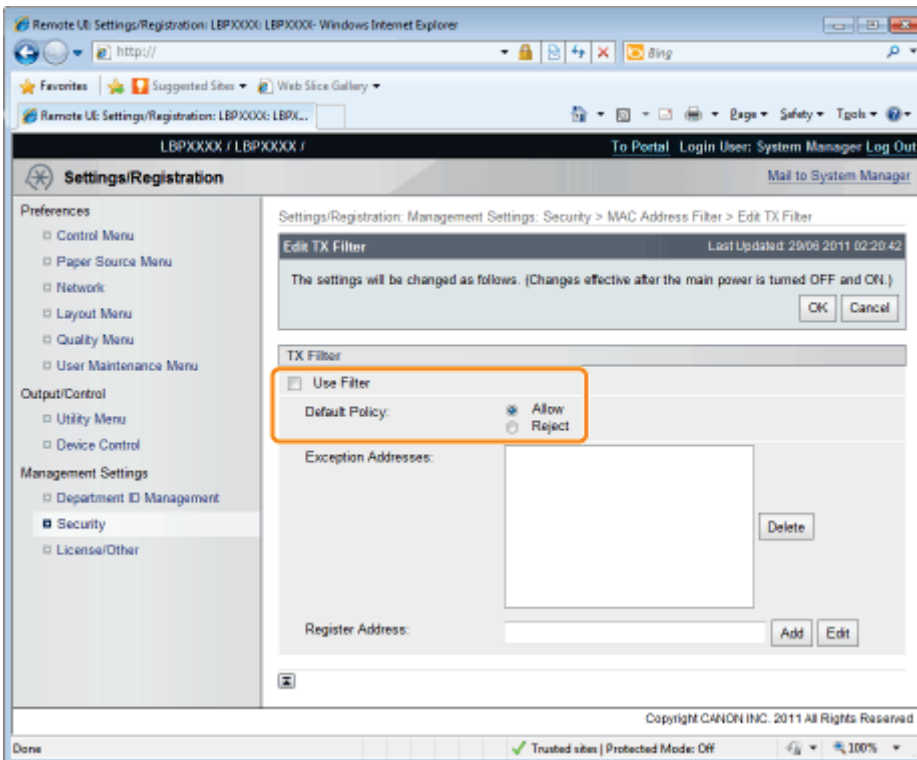

- If you select [Reject], you will not be able to transmit or print from users (clients) entered in the [Exception Addresses] field.
- If you select [Allow], you will only be able to transmit or print from users (clients) entered in the [Exception Addresses] field.
- If you clear the [Use Filter] check box, you will be able to transmit and print from all users (clients).

7

Set the MAC address.

(1) Enter the MAC address of a device of which you want to permit to access.

† Enter the MAC address without the hyphens (-), for example, AABBCCDDEEFF.

(2) Click [Add].

† You can set up to 50 addresses.

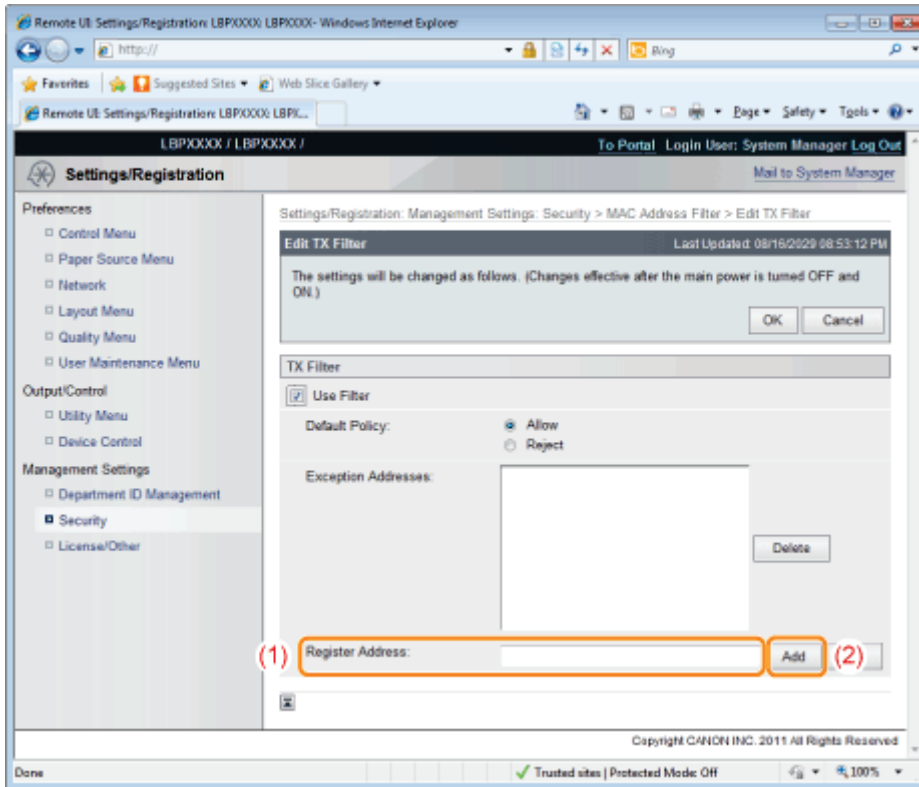

NOTE

When deleting a set MAC address

(1) Select a MAC address you want to delete.

(2) Click [Delete].

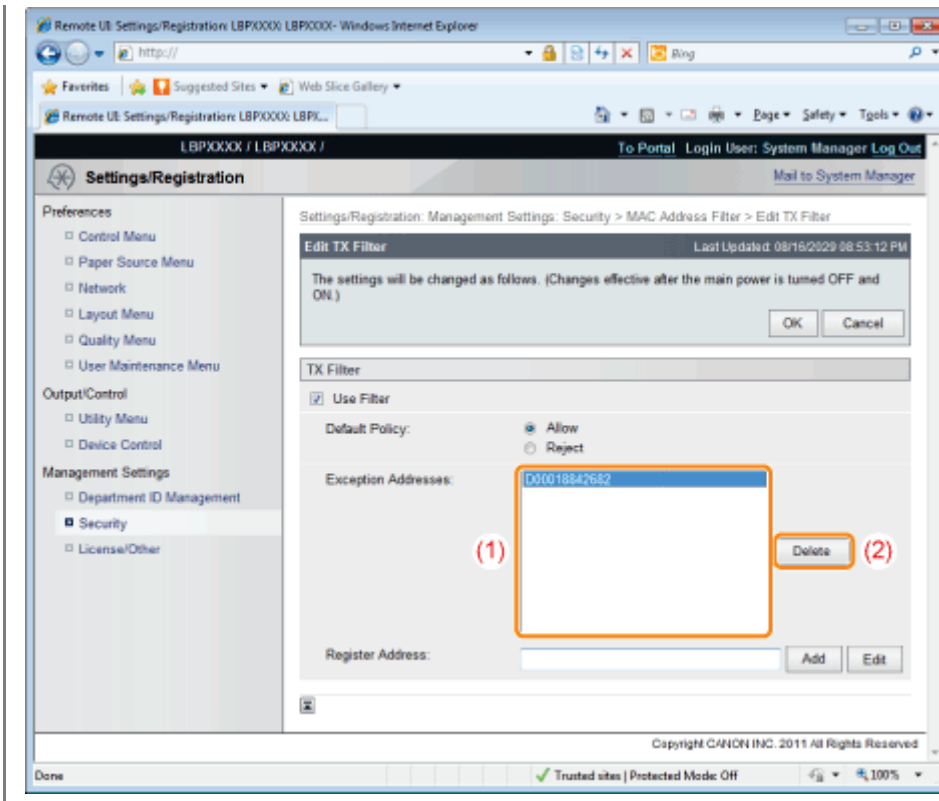

8

Click [OK].

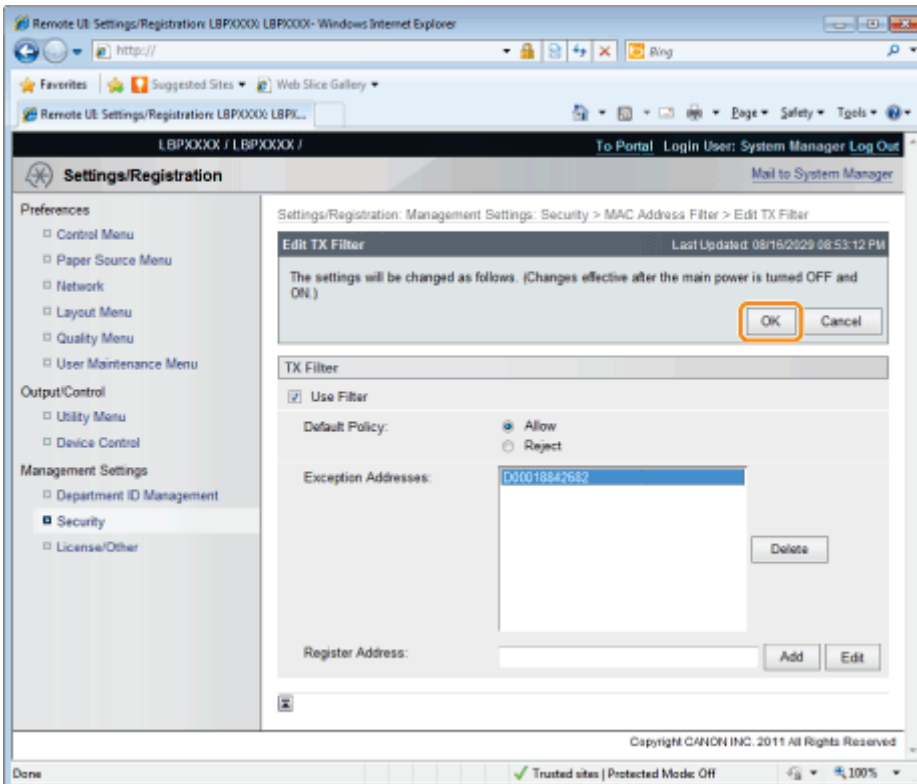

9

Perform a hard reset or restart the printer.

→ After performing a hard reset or restarting the printer, the settings are effective.

 **NOTE**

To perform a hard reset

You can perform a hard reset using the following procedure.

1. Click [Settings/Registration].
2. Select [Device Control] from the [Output/Control] menu.
3. Select [Hard Reset], and then click [Execute].

Setting Restrictions for Print Jobs

04L9-0S2

You can use a Web browser (Remote UI) to set restrictions for print jobs.

IMPORTANT

When restrictions for print jobs are set, the effect will be as follows.

Type of job		Restriction
Printer Driver		Will be stored in a box.
Direct Print	Image File	Will not be displayed in the menu.*
	PS/PDF	Will be stored in a box.
	XPS	Will be stored in a box.
USB Direct Print		Cannot be output.
Utility Menu		There are no restrictions.

*The settings will be enabled after a hard reset or after the printer is restarted.

➤ "Canceling All the Jobs (Hard Reset)"

1

Start the Remote UI, and then log in as Administrator.

➤ "Starting the Remote UI"

2

Click [Settings/Registration].

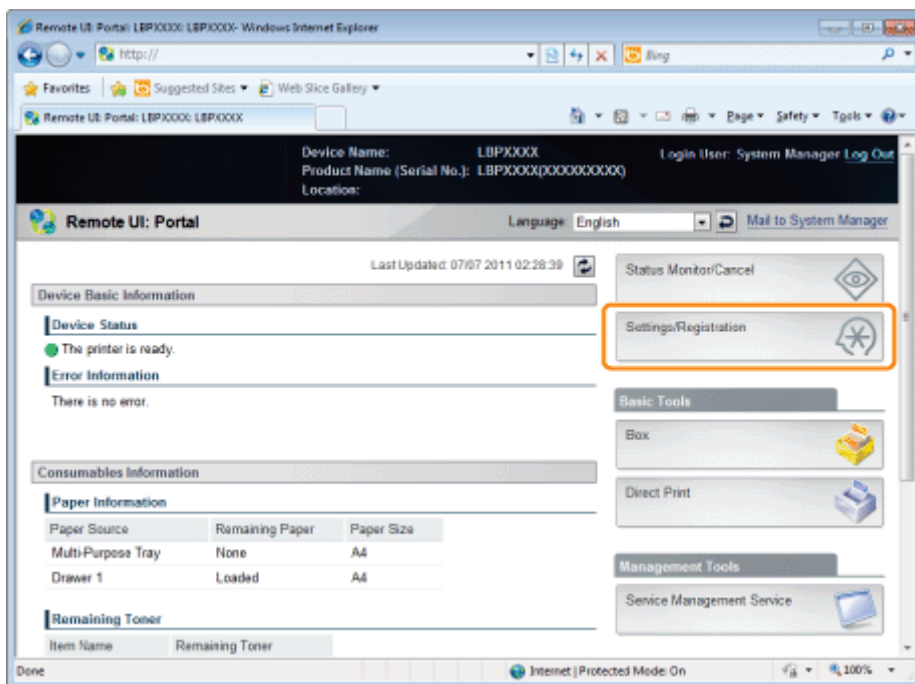

3

Select [Security] from the [Management Settings] menu.

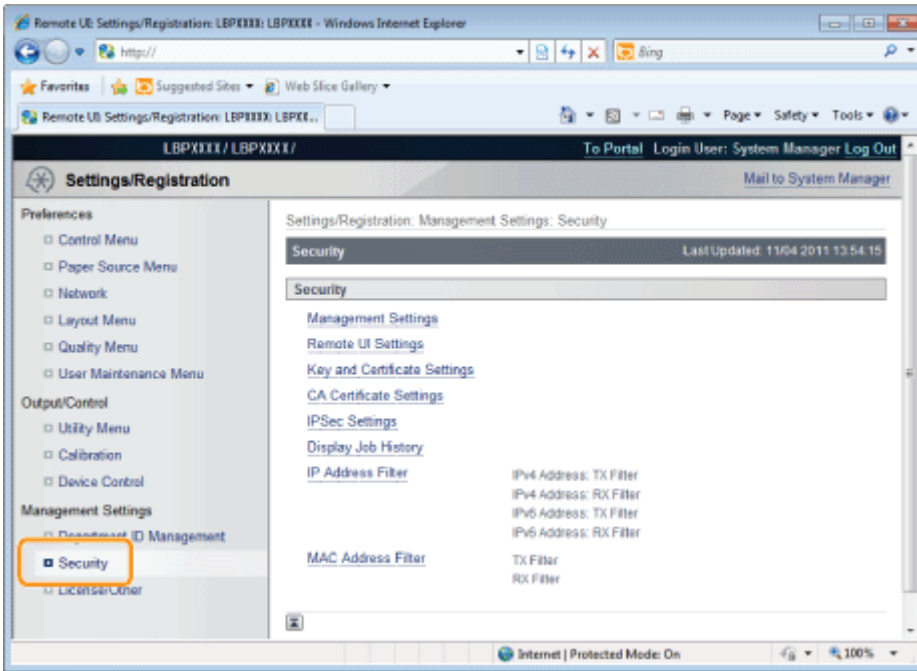

4

Click [Management Settings].

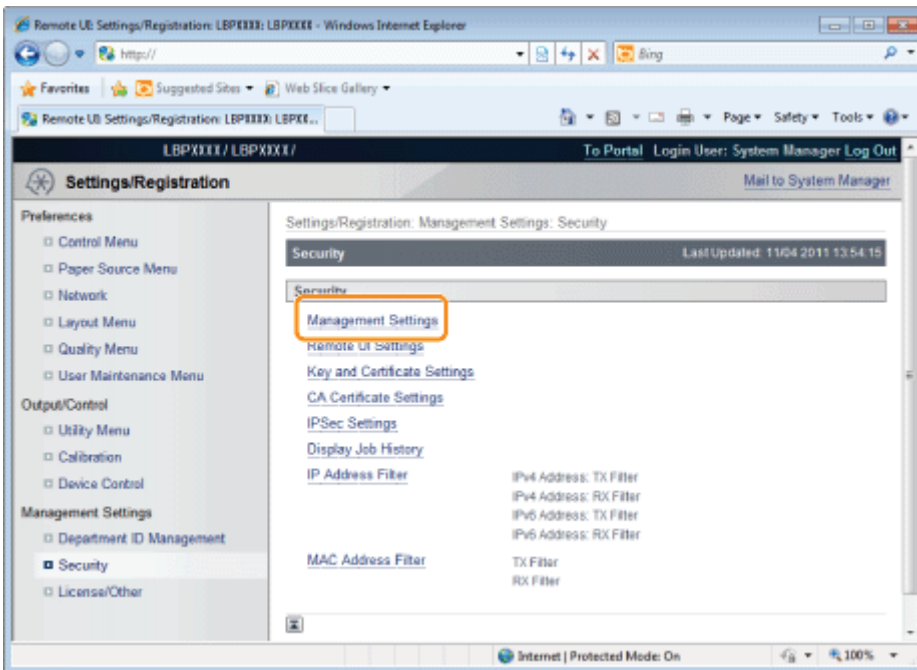

5

Click [Edit...].

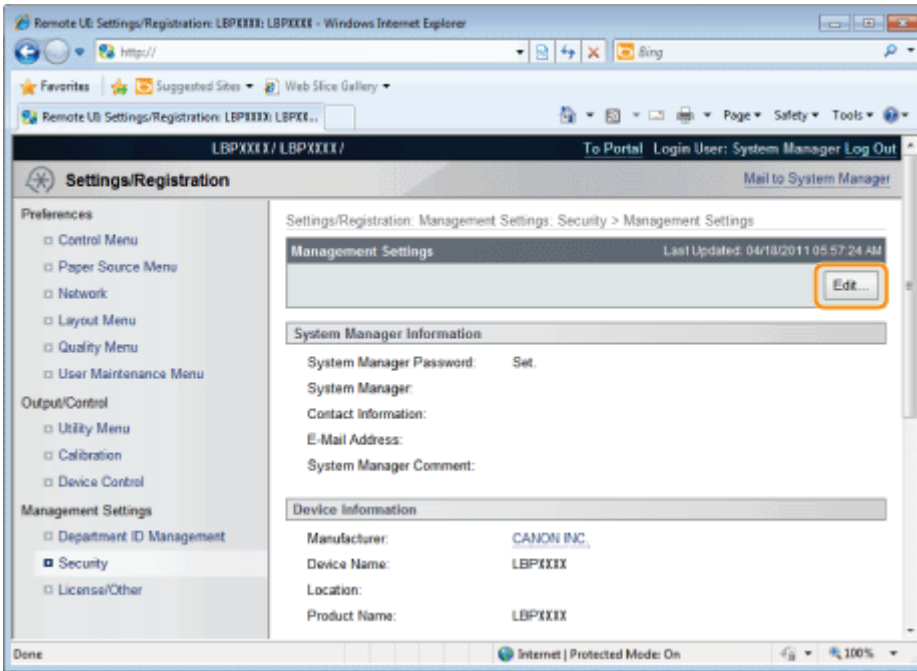

6

Enter the current password in [Current System Manager Password].

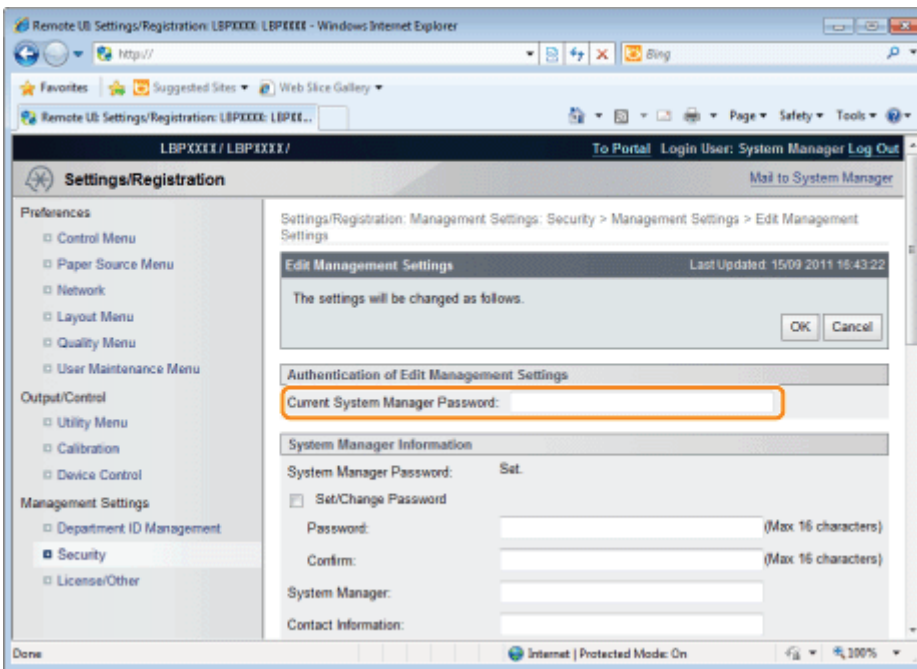

7

Set restrictions for print jobs.

- (1) Select the [Restrict Printer Jobs] check box.
- (2) Click [OK].

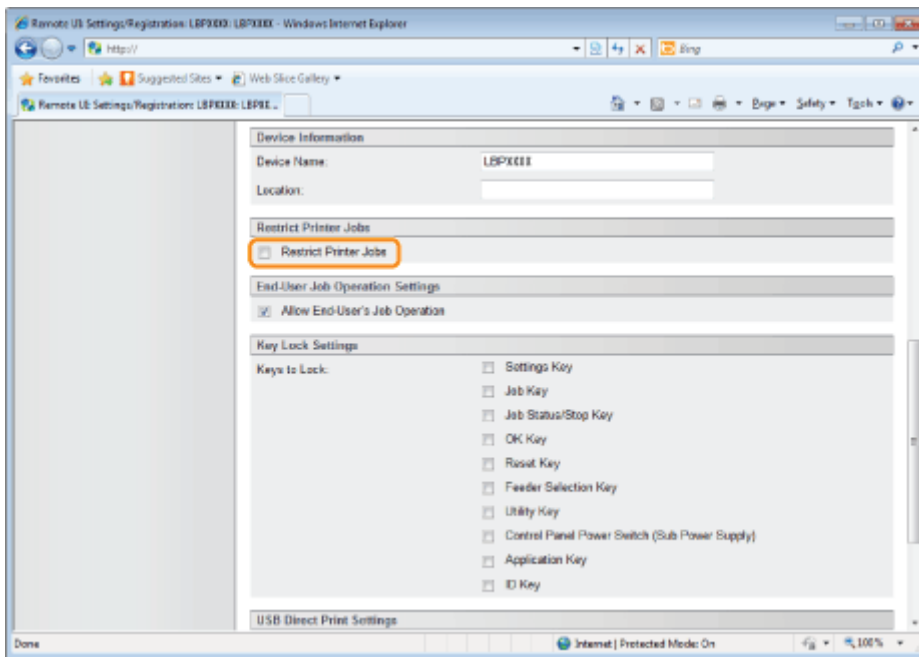

Specifying the Job Operation Permission for End-Users

04L9-0E1

You can specify the job operation permission for end-users using a Web browser (Remote UI).

If the job operation by end-users is permitted, the job operation by the name entered when logging on (the user name) becomes enabled when you are using the Remote UI in End-User Mode.

1

Start the Remote UI, and then log in as Administrator.

❖ "Starting the Remote UI"

2

Click [Settings/Registration].

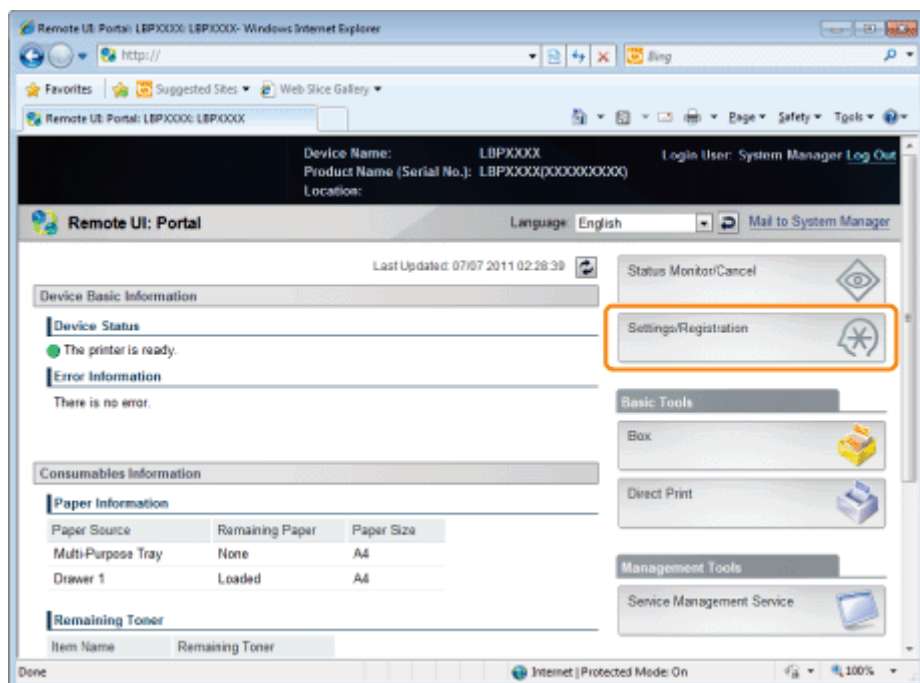

3

Select [Security] from the [Management Settings] menu.

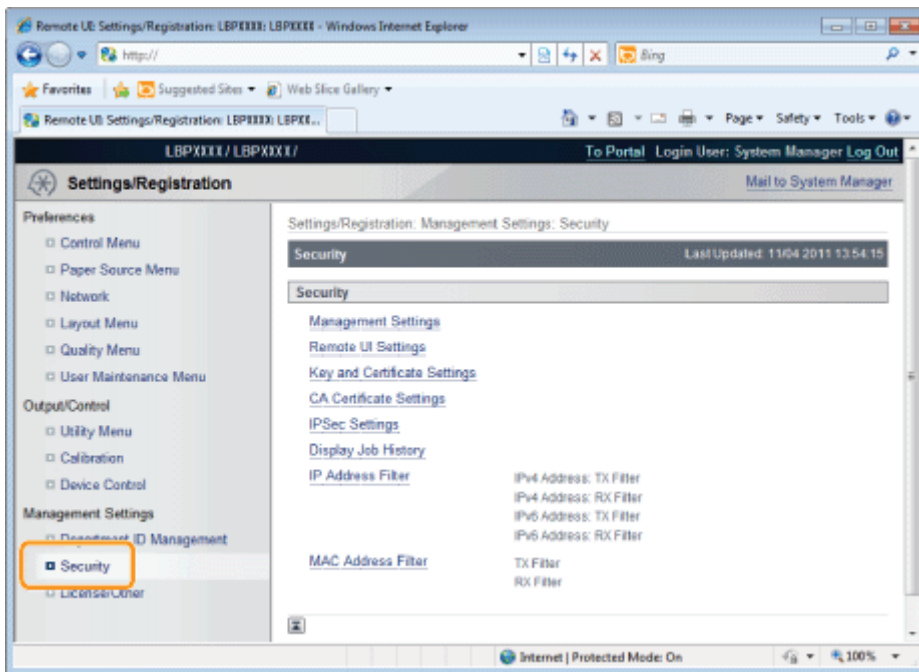

4

Click [Management Settings].

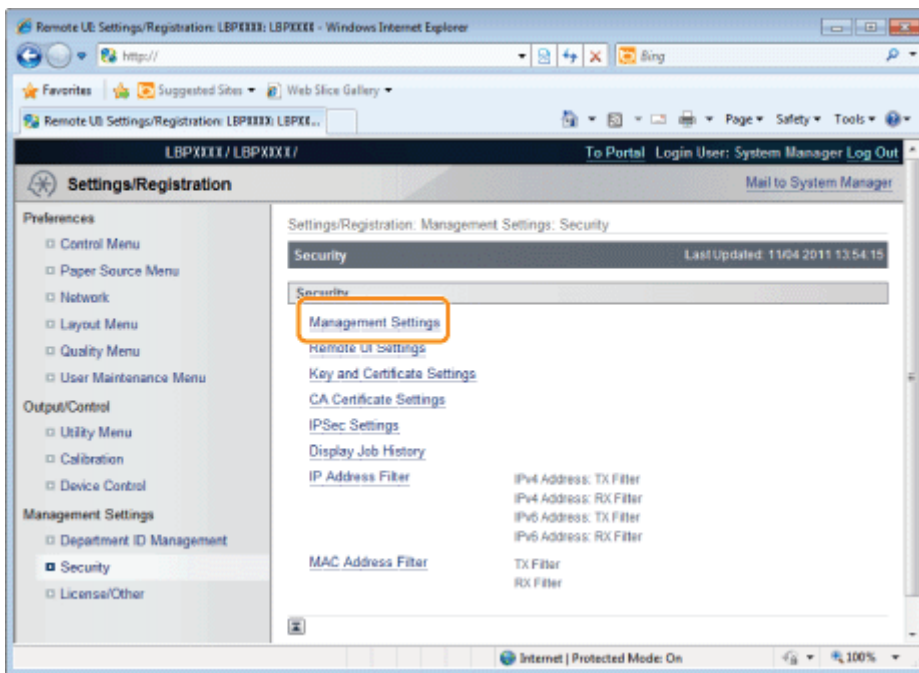

5

Click [Edit...].

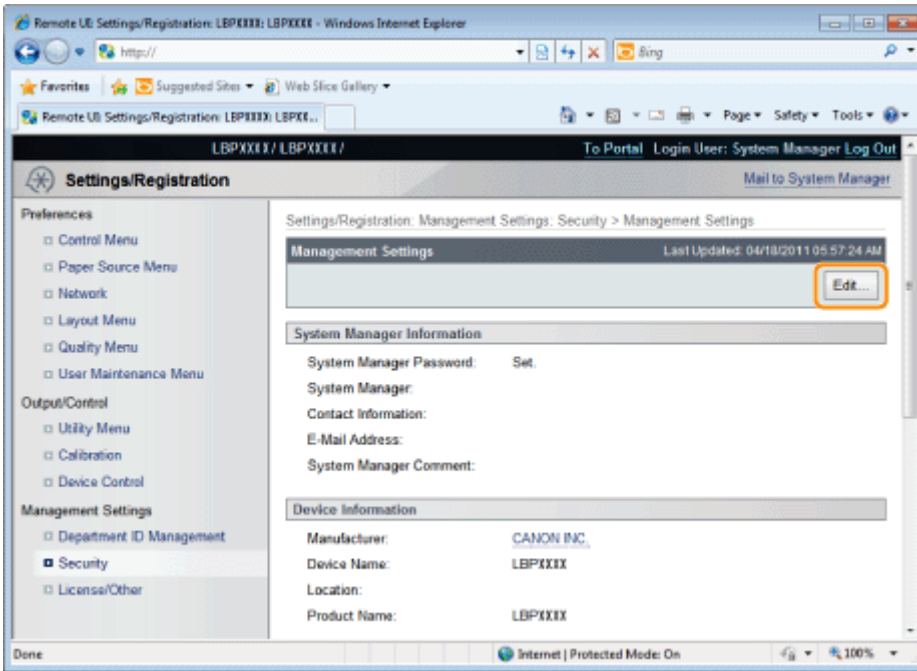

6 Enter the current password in [Current System Manager Password].

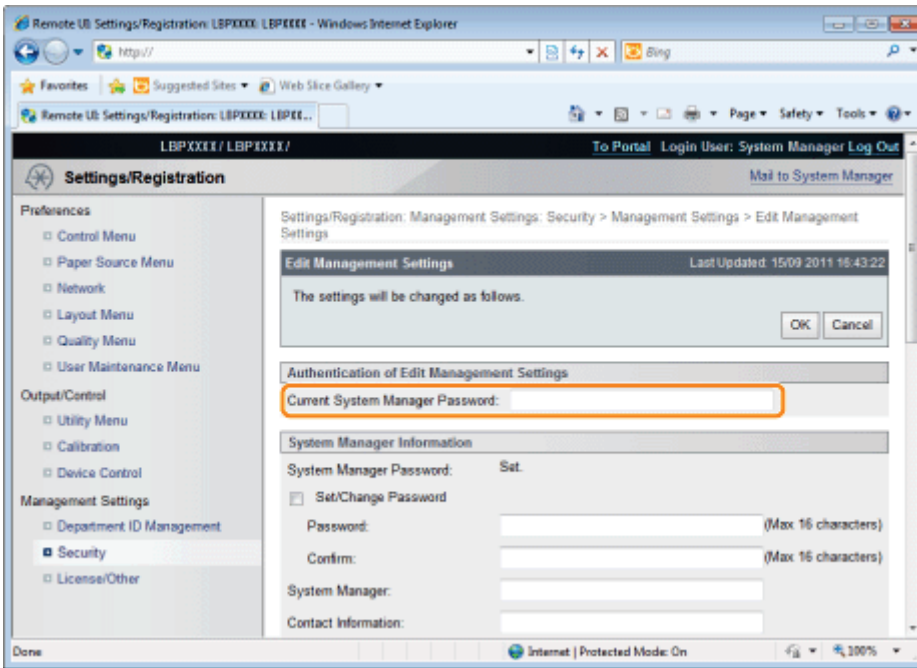

7 Specify the job operation permission for end-users.

- (1) Select the [Allow End-User's Job Operation] check box.
 - † If the check box is cleared, End-User cannot operate all the jobs.
- (2) Click [OK].

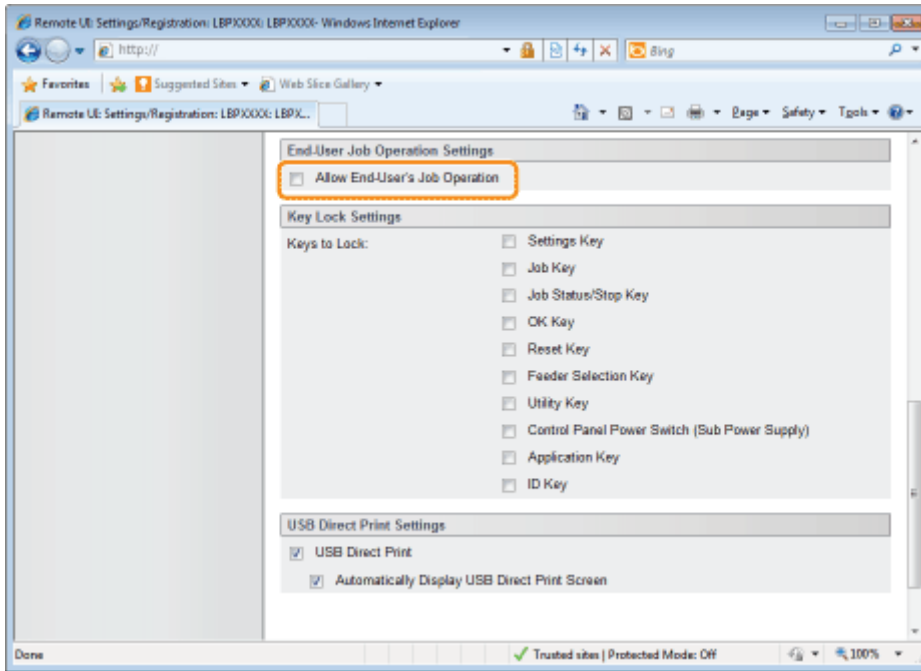

Locking the Keys on the Control Panel (Key Lock Function)

04L9-0E2

You can set the key lock function using a Web browser (Remote UI).

When using the key lock function, you can lock the keys on the control panel, prohibiting the change of the printer settings by a user other than the administrators.

IMPORTANT

If pressing a locked key

The printer beeps and the message <Key locked.> is displayed on the display.

Precautions when setting the key lock function

Set the key lock function while the keys are not being operated.

If the key lock function is set while the keys are being operated, the key lock function is enabled after the key operation.

1

Start the Remote UI and log on in system manager mode.

➤ "Starting the Remote UI"

2

Click [Settings/Registration].

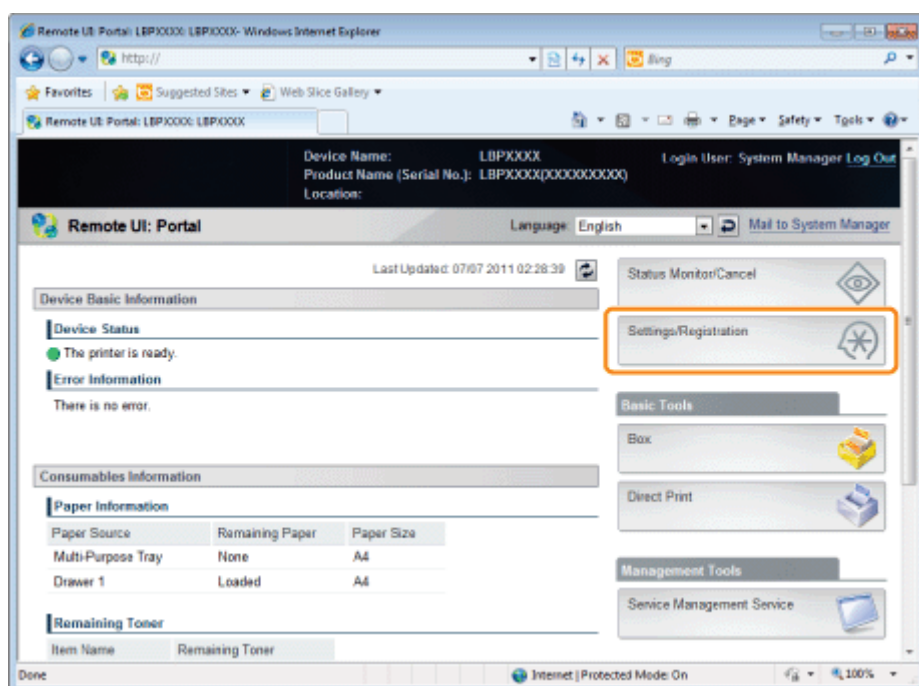

3

Select [Security] in the [Management Settings] menu.

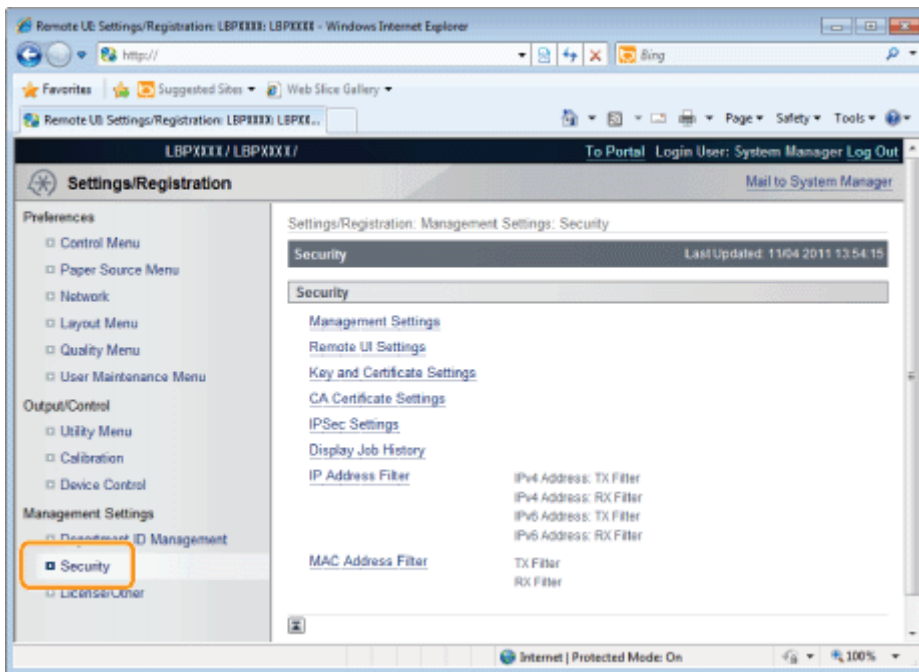

4

Click [Management Settings].

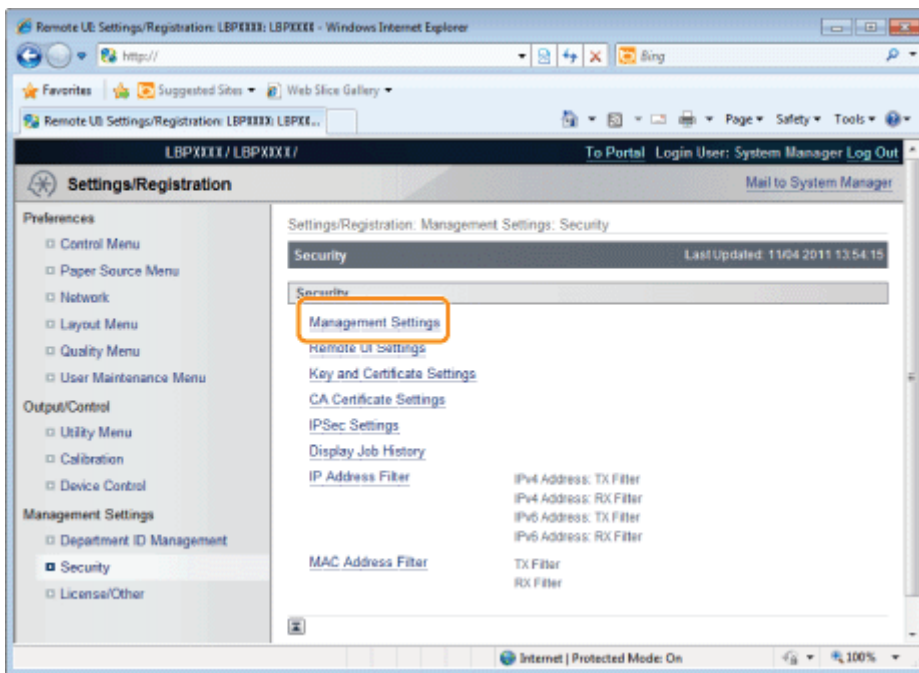

5

Click [Edit...].

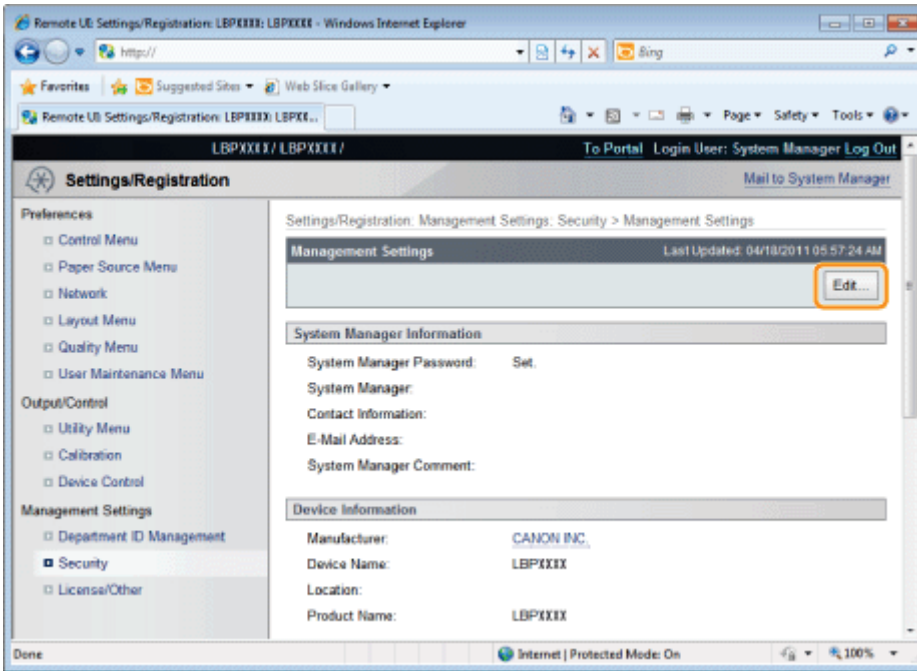

6

Enter the current password in [Current System Manager Password].

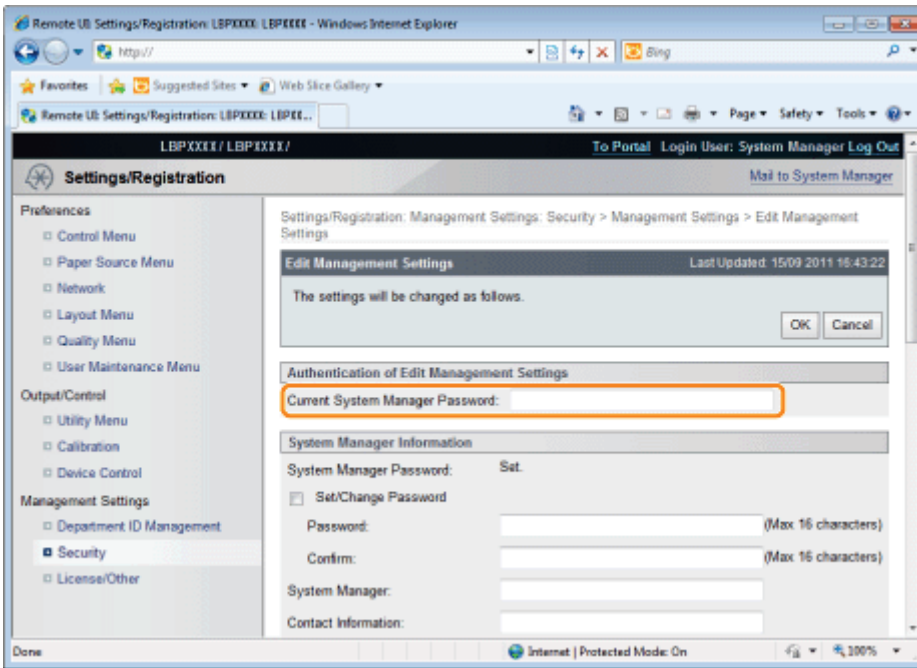

7

Specify the keys which you want to lock.

- (1) Select the check boxes respectively for keys, which you want to lock, on the control panel on the printer.
† For details on the keys, see "[Control Panel](#)."
- (2) Click [OK].

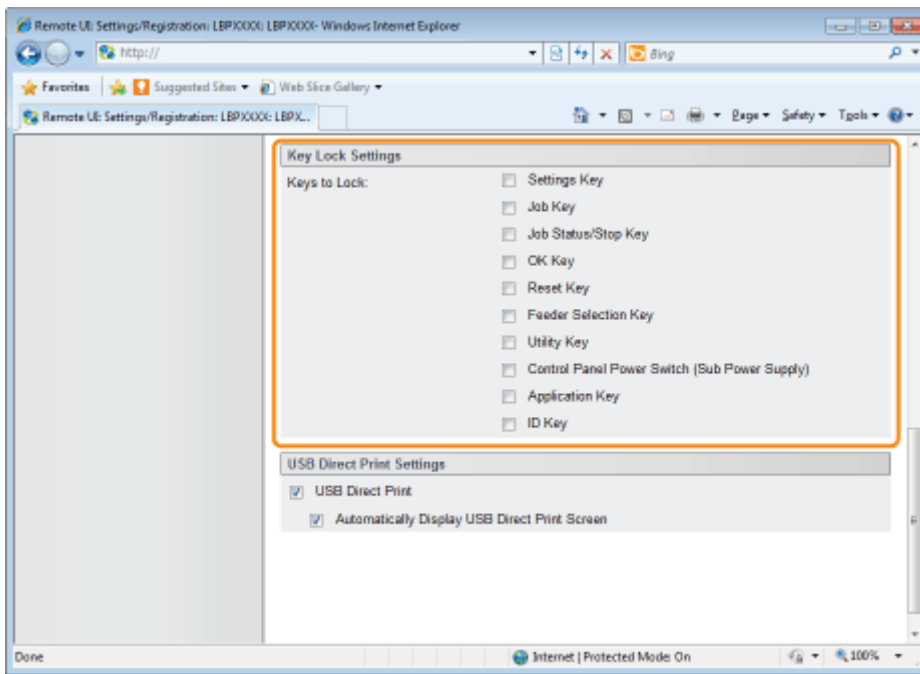

Setting Restrictions for USB Direct Print (LBP6680x Only)

04L9-0SA

You can use the Web browser (Remote UI) to set restrictions for USB Direct Print.

1

Start the Remote UI, and then log in as Administrator.

❖ "Starting the Remote UI"

2

Click [Settings/Registration].

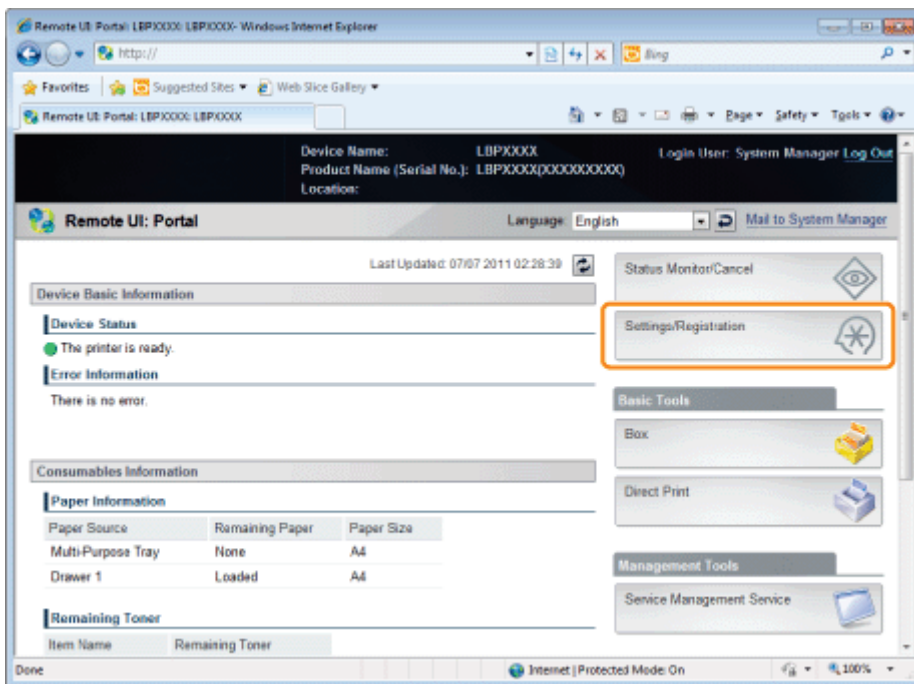

3

Select [Security] from the [Management Settings] menu.

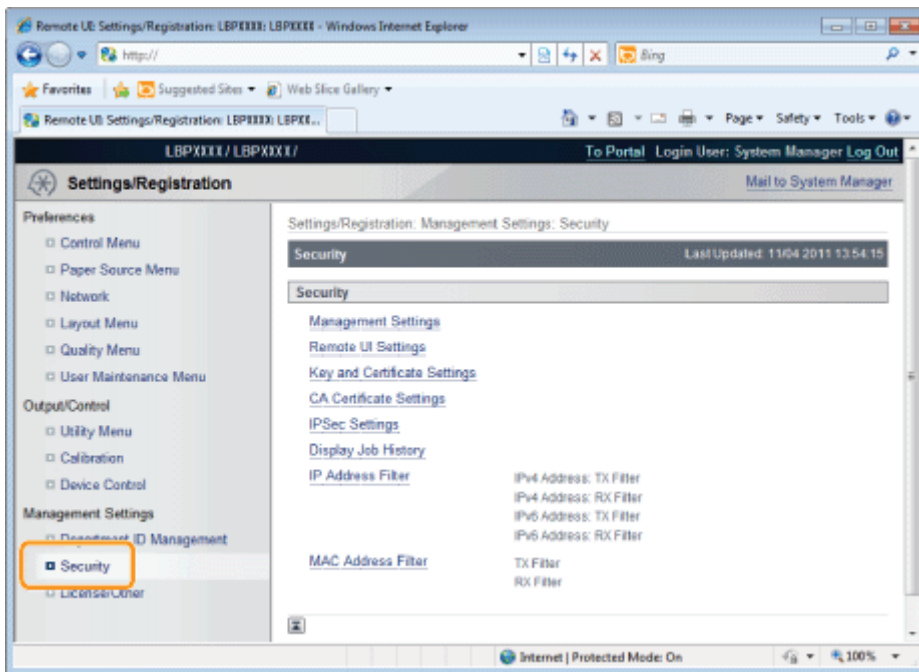

4

Click [Management Settings].

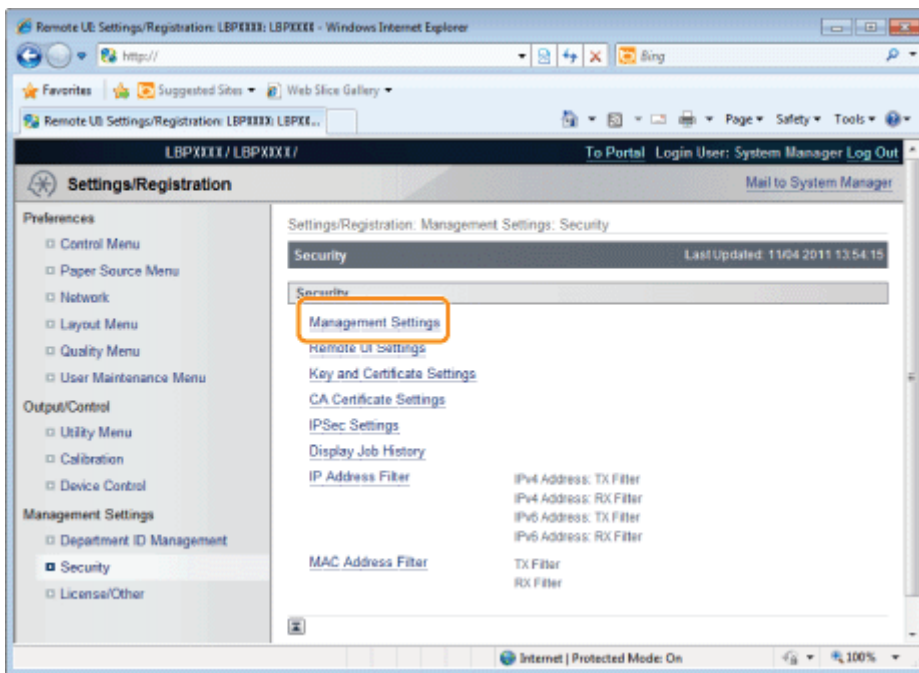

5

Click [Edit...].

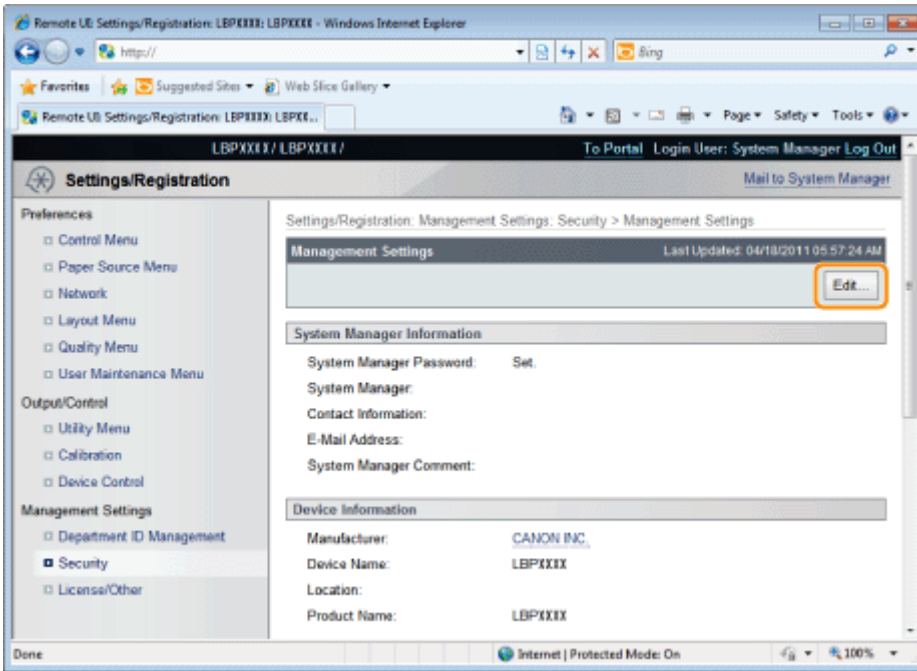

6 Enter the current password in [Current System Manager Password].

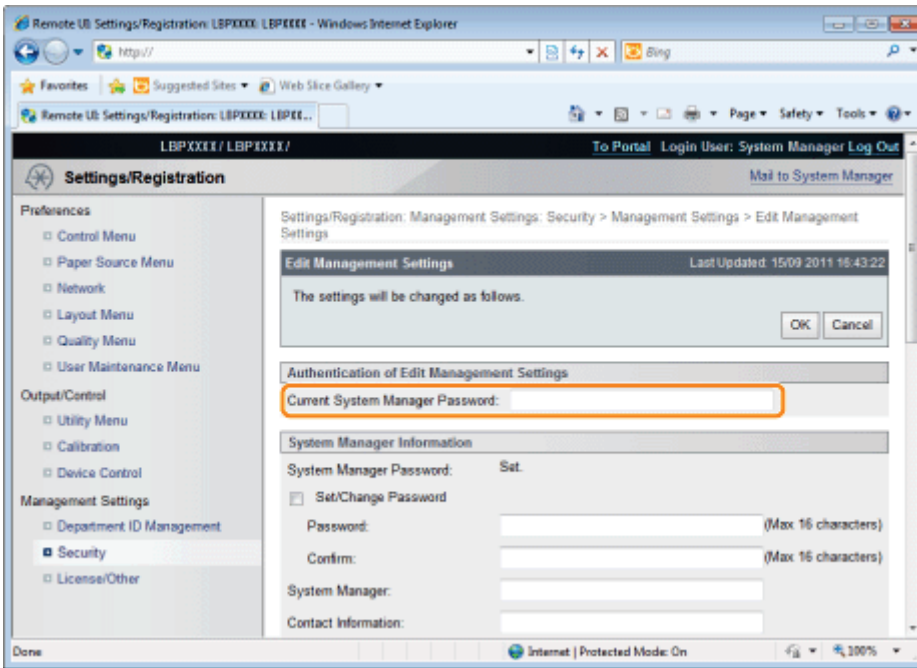

7 Set restrictions for USB Direct Print.

- (1) Clear the [USB Direct Print] check box.
 - † If the check box is selected, the USB Direct Print function is enabled.
 - † If the [Automatically Display USB Direct Print Screen] check box is selected, the USB Direct Print screen is automatically displayed when the USB memory device is inserted.
- (2) Click [OK].

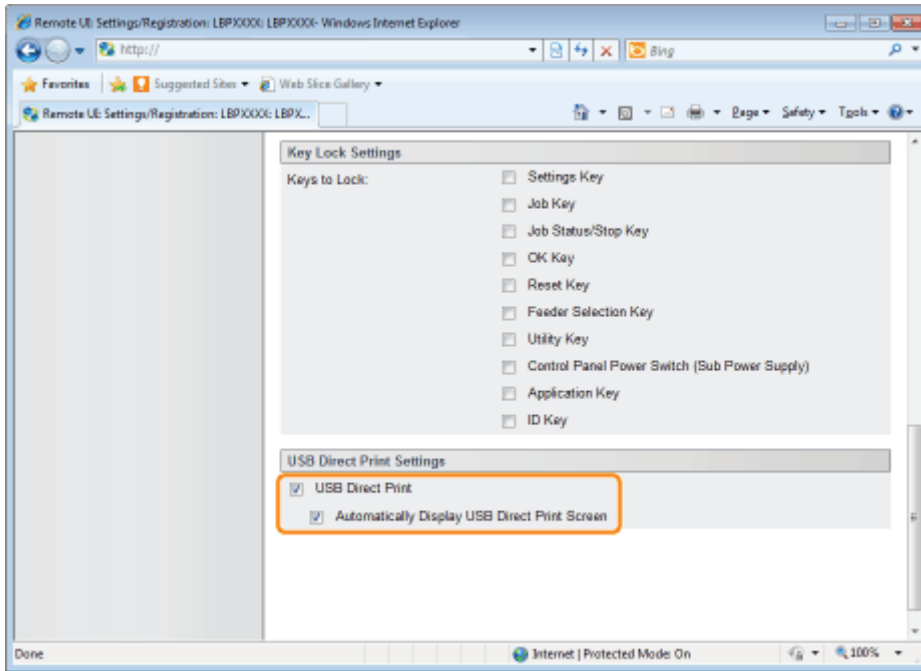

Setting Keys and Certificates

04L9-0E4

When using SSL encrypted communication, IEEE802.1X authentication or IPSec encrypted communication, authentication settings are necessary for the user to check the public key for encryption, the private key for decryption and key information.

See the following according to your system environment and the options that you want to specify.

- When creating and using a key and its certificate with this printer
 - ❖ [Displaying the \[Key and Certificate Settings\] Page in the Remote UI](#)
 - ❖ [Newly Creating a Key and Its Certificate](#)
Newly create a key pair (the public key and private key) and its certificate.
 - ❖ [Checking a Certificate](#)
Confirm the contents of the certificate of a created key.
 - ❖ [Deleting a Key and Its Certificate](#)
Delete a created key and its certificate.
- When using a key/certificate file created by a device other than this printer
 - ❖ [Displaying the \[Key and Certificate Settings\] Page in the Remote UI](#)
 - ❖ [Installing a Key/Certificate File on the Printer](#)
Install a key/certificate file created by a device other than this printer on this printer.
 - ❖ [Registering a Key and Its Certificate in the Printer](#)
Register a key pair (the public key and private key) and its certificate in a key/certificate file installed on this printer so that you can use them in the printer.
 - ❖ [Checking a Certificate](#)
Confirm the contents of the certificate of a created key.
 - ❖ [Deleting a Key and Its Certificate](#)
Delete a created key and its certificate.

IMPORTANT

The number of key and certificate which you can create, register, or install

You can create and register up to six "keys and certificates" (the total includes the one that is installed). Also, only one key and certificate file can be installed. If you cannot create, register or install them, delete unnecessary keys and certificates.

About a Key/Certificate File which can be installed on this printer

- The key generation algorithm is "RSA". You can only install files with the extensions ".P12" or ".PFX".
- The file format which you can register is a PKCS#12 file in DER (binary encoding) format.

Displaying the [Key and Certificate Settings] Page in the Remote UI

04L9-0E5

1

Start the Remote UI, and then log in as Administrator.

➤ "Starting the Remote UI"

2

Click [Settings/Registration].

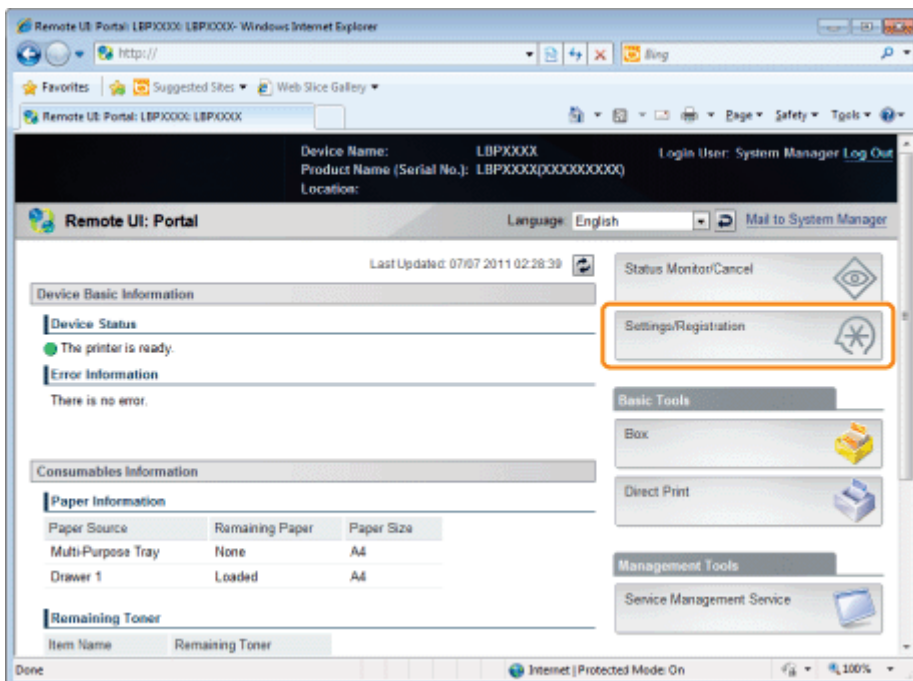

3

Select [Security] from the [Management Settings] menu.

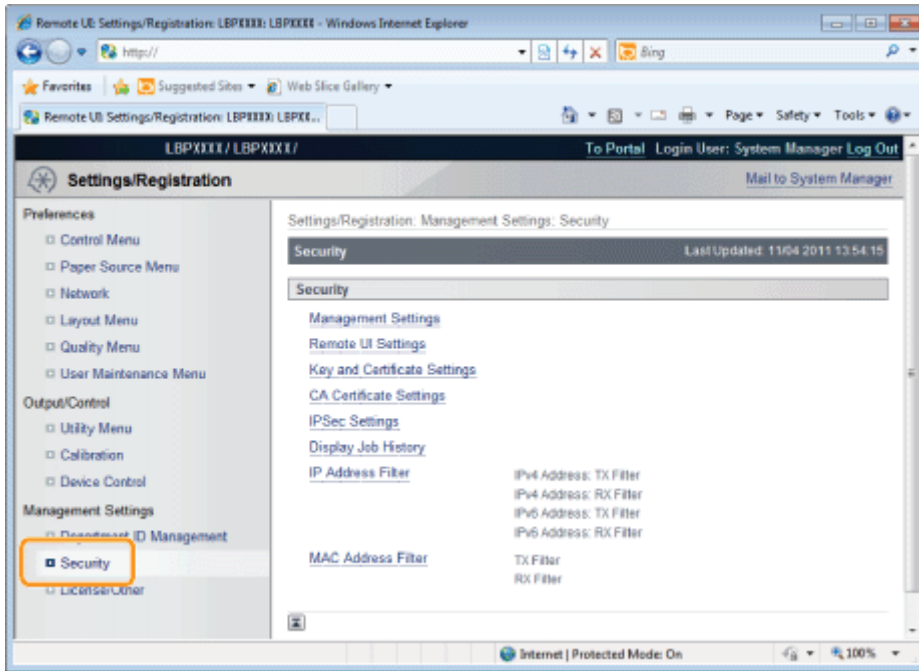

4

Click [Key and Certificate Settings].

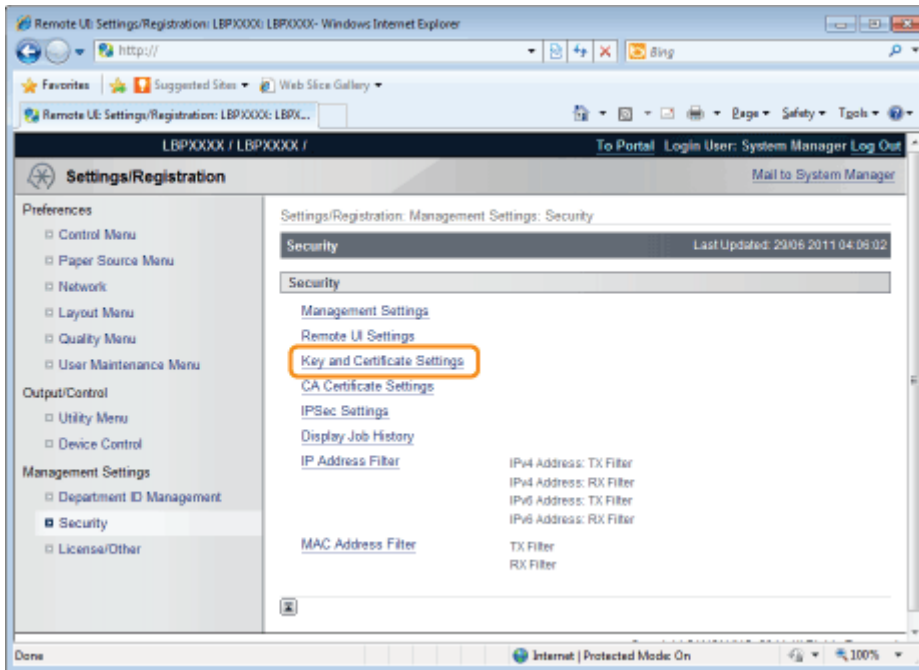

Newly Creating a Key and Its Certificate

04L9-0E6

1

Click [Generate Key...].

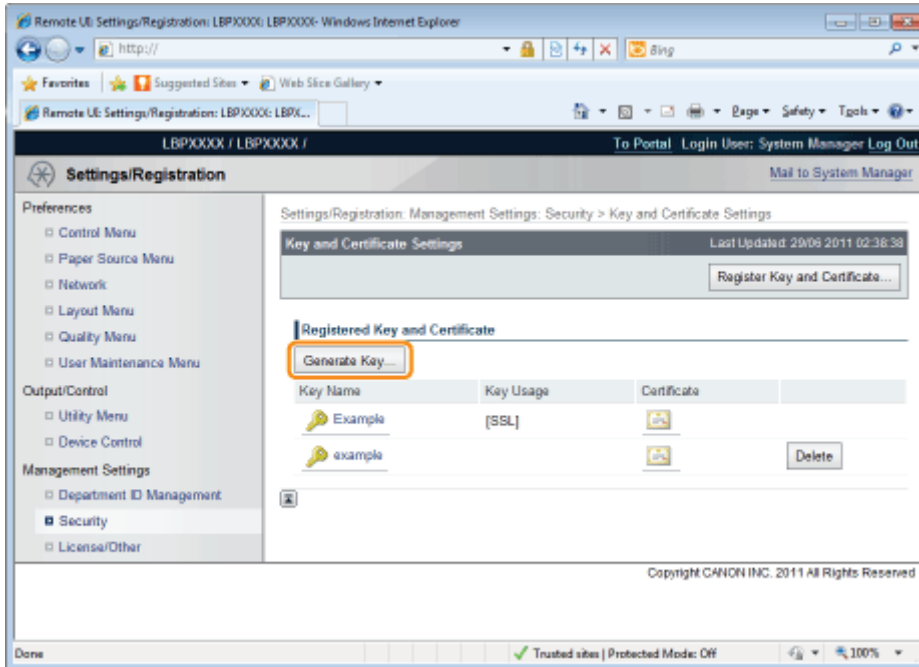

2

Enter the name of the key to be newly created.

Up to 24 alphanumeric characters can be entered.

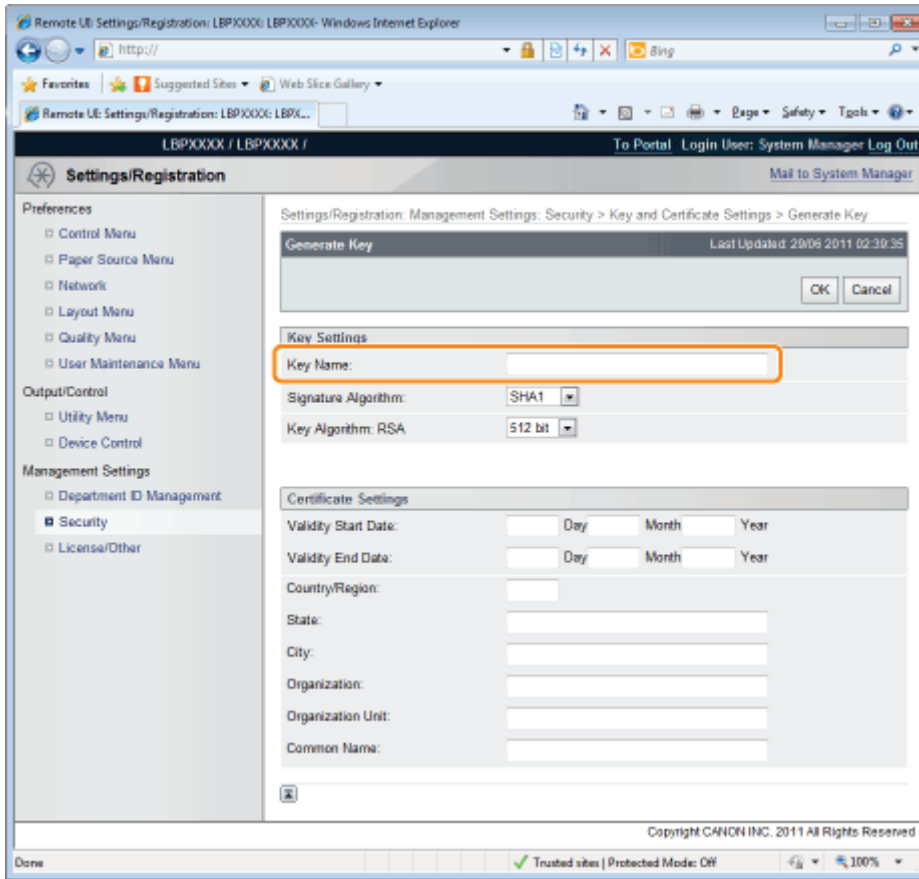

3

Select [Signature Algorithm].

Select from [SHA1], [SHA256], [SHA384], or [SHA512].

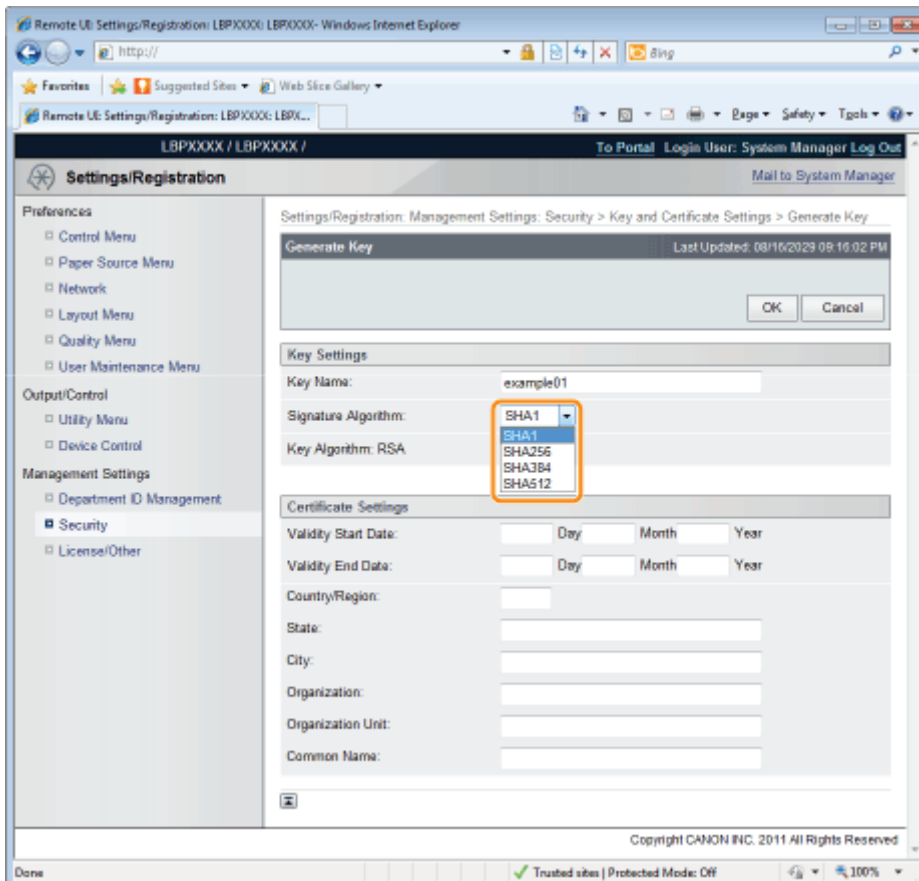

4

Select [Key Algorithm].

Select from [512 bit], [1024 bit], [2048 bit], or [4096 bit].

† When you select [SHA384] and [SHA512] in [Signature Algorithm], you can create a key only when selecting other than [512 bit].

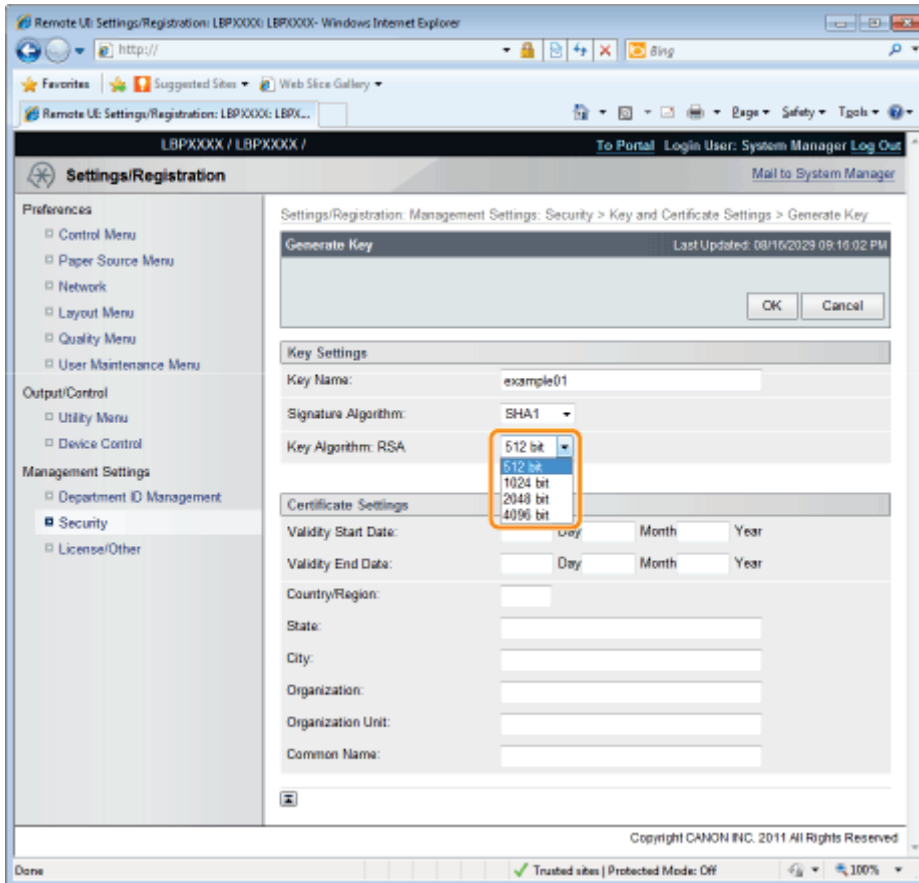

NOTE

Key Generation Algorithm

The generation algorithm when the printer generates a key is RSA.

About the key length

Although using the longer key makes it more difficult to decode data, the processing speed on encryption and decryption is slower.

Select the key length according to the needs of security for data communication.

5

Specify the effective date and expiration date of the self-sign server certificate.

You can enter date between 1/1/2000 (1 Day 1 Month 2000 Year) and 31/12/2037 (31 Day 12 Month 2037 Year).

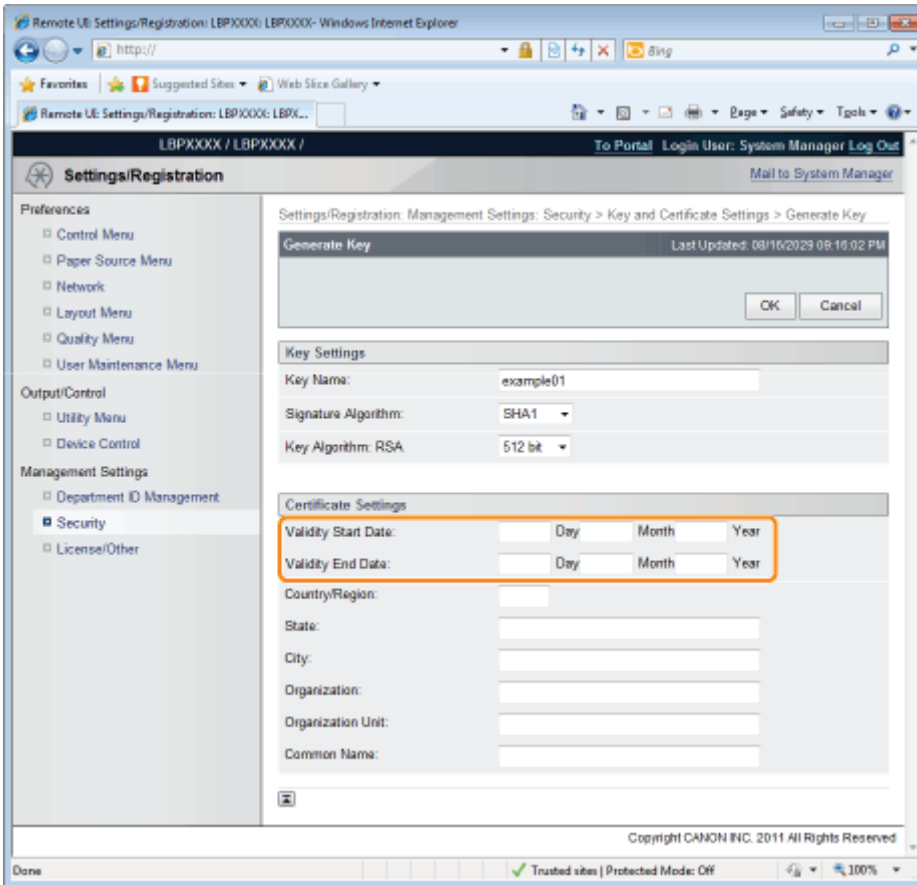

6

Specify the country/region name for the self-sign server certificate.

Enter the Internet country code with 2 or less characters.

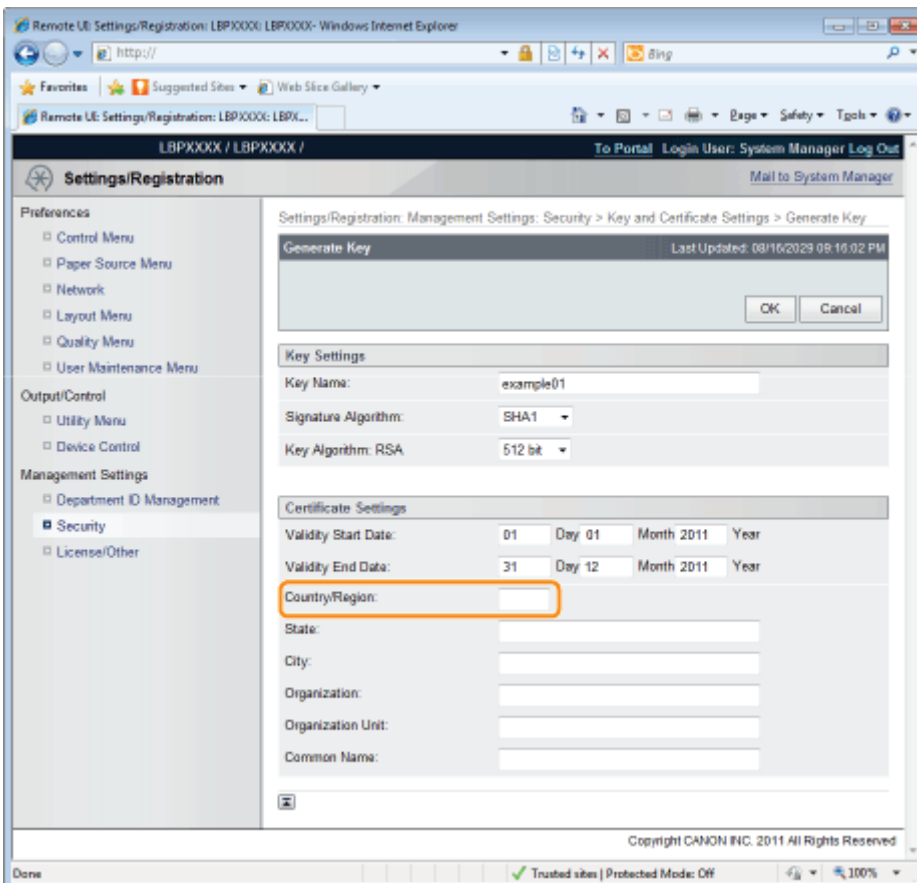

7

Specify the required information for the self-sign server certificate.

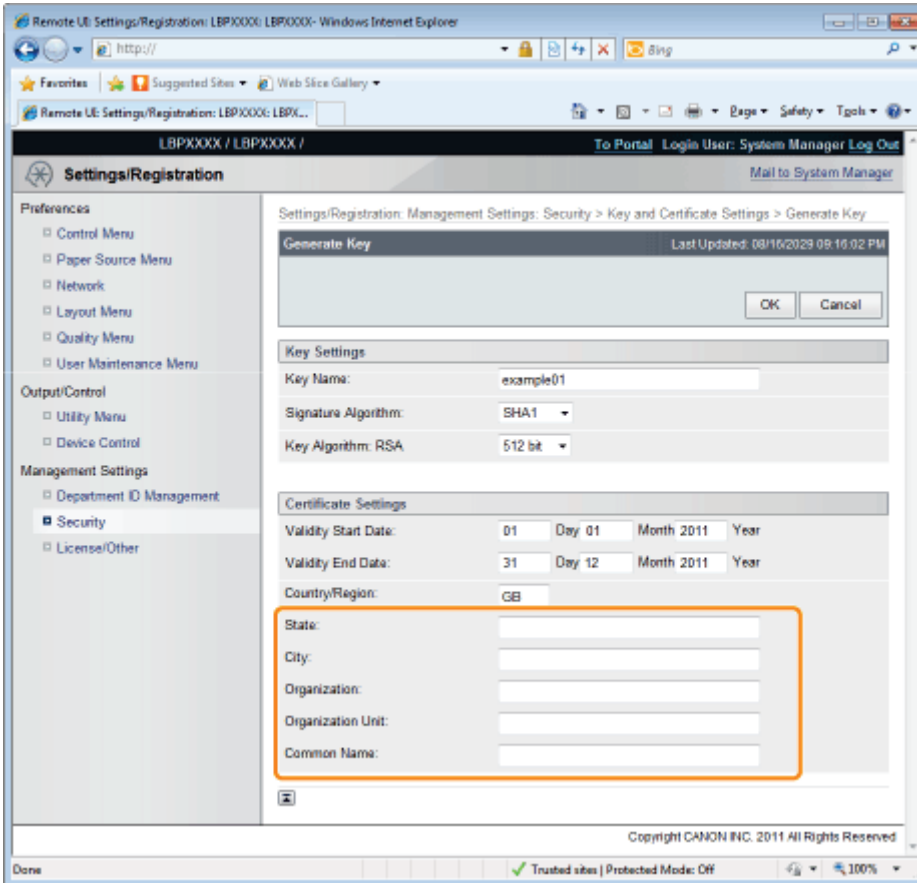

[State]:	Enter the name of the state. Up to 24 alphanumeric characters can be entered.
[City]:	Enter the name of the city. Up to 24 alphanumeric characters can be entered.
[Organization]:	Enter the name of the organization. Up to 24 alphanumeric characters can be entered.
[Organization Unit]:	Enter the organization unit such as a section name. Up to 24 alphanumeric characters can be entered.
[Common Name]:	Enter the IP address or FQDN (in the style of "xyz.company.com") of this printer. Up to 41 alphanumeric characters can be entered.

IMPORTANT

To issue the self-sign server certificate

Specify the setting for at least one of the options among [Country/Region], [State], [City], [Organization], [Organization Unit], and [Common Name].

When all the fields are blank, the self-sign server certificate is not issued.

If you are using Windows Vista, 7 or Server 2008

[Common Name] needs to be the same as the name (FQDN) or IP address that is specified for IPPS connection.

- For FQDN, enter "FQDN" in [Common Name].
 - For IP address, enter the IP address of this printer in [Common Name].
- [Obtaining the Public Key for This Printer When Using SSL Encrypted Communication](#)

8

Click **[OK]**.

→ The key and certificate creation starts.

Remote UI: Settings/Registration: LBPXXXX: LBPXXXX- Windows Internet Explorer

http://

Remote UI: Settings/Registration: LBPXXXX: LBPX...

LBPXXXX / LBPXXXX / To Portal Login User: System Manager Log Out Mail to System Manager

Settings/Registration

Settings/Registration: Management Settings: Security > Key and Certificate Settings > Generate Key

Generate Key Last Updated: 08/16/2013 09:16:02 PM

Key Settings

Key Name: example01

Signature Algorithm: SHA1

Key Algorithm: RSA 512 bit

Certificate Settings

Validity Start Date: 01 Day 01 Month 2011 Year

Validity End Date: 31 Day 12 Month 2011 Year

Country/Region: GB

State: _____

City: _____

Organization: _____

Organization Unit: _____

Common Name: _____

Copyright CANON INC. 2011 All Rights Reserved

Done Trusted sites | Protected Mode: Off 100%

Installing a Key/Certificate File on the Printer

04L9-0E7

1

Click **[Register Key and Certificate...]**.

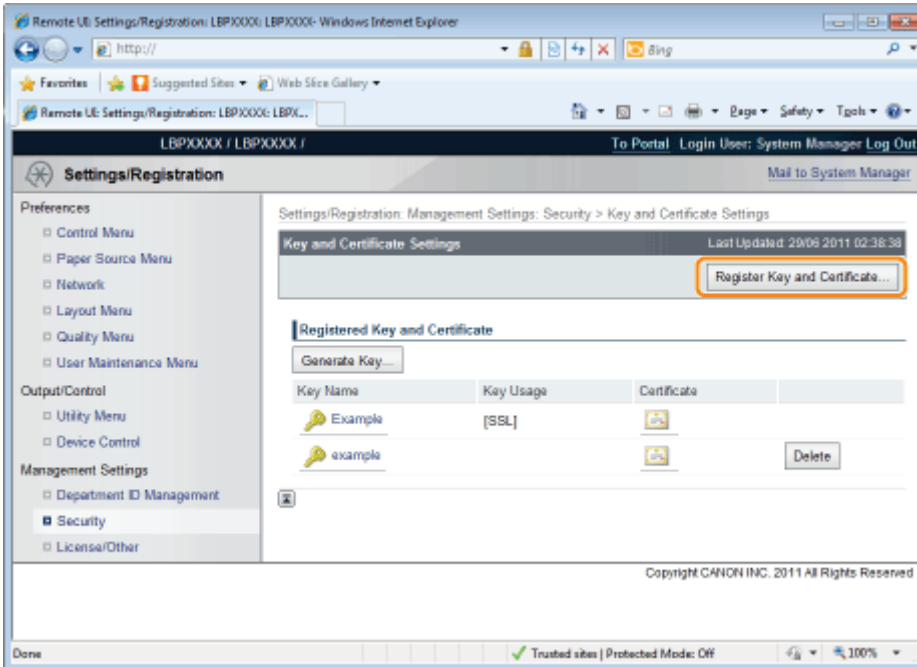

2

Click **[Install...]**.

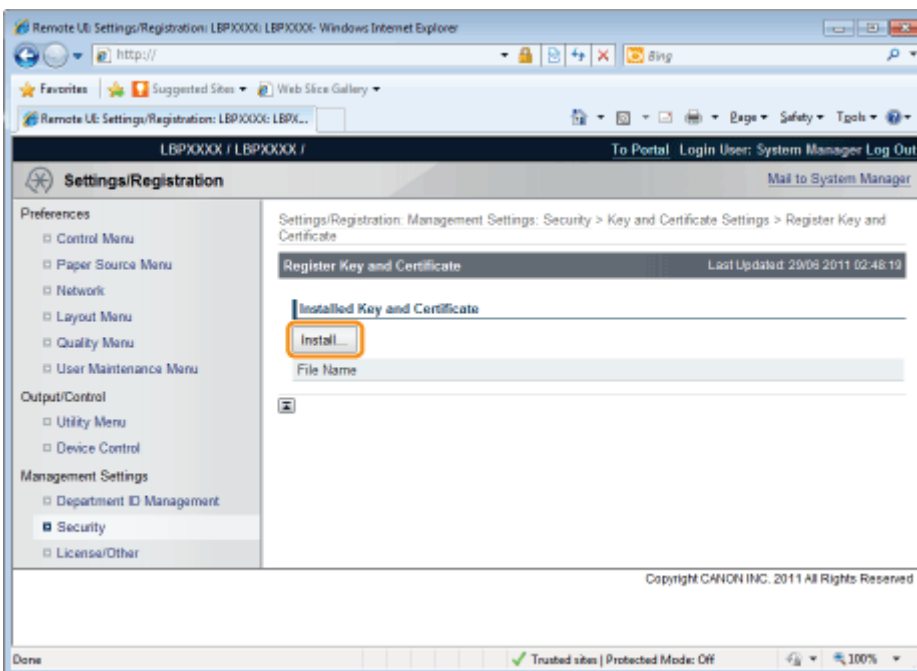

3

Specify the directory of a key/certificate file.

Click [Browse...] to select the key/certificate file or enter the directory for the saved key/certificate file.

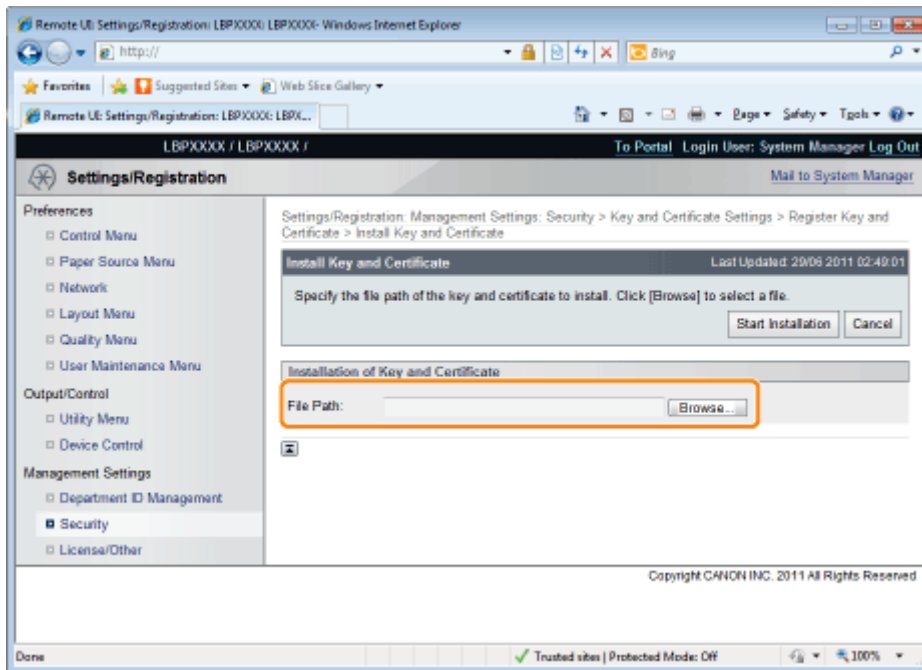

NOTE

About the name of the key/certificate file

Except for the extension up to 20 alphanumeric characters can be specified in [File Path] for the file name. Specify the file name so that its length is 20 characters or less.

4

Click [Start Installation].

→ The installation of the key/certificate file starts.

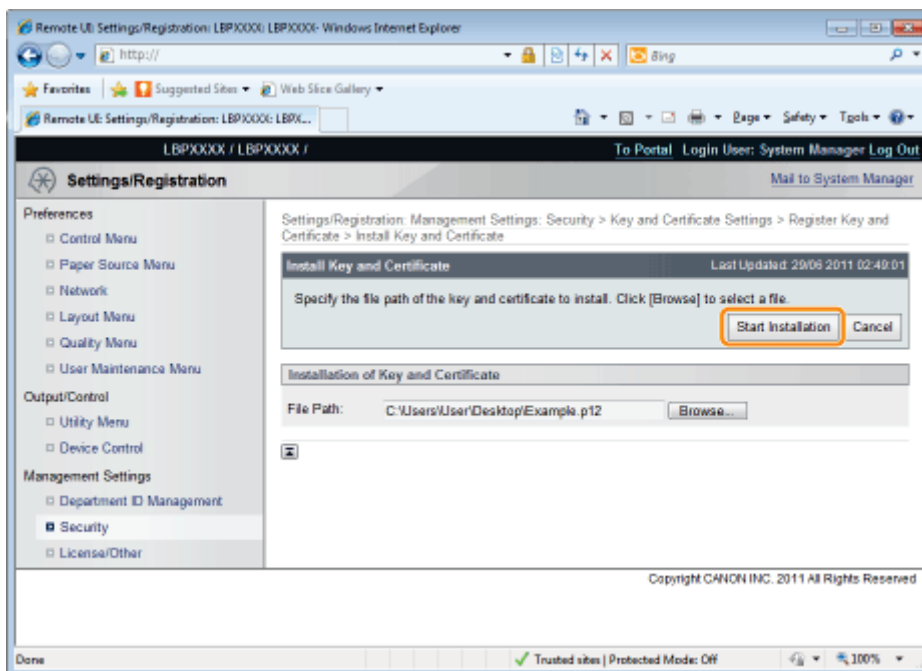

To specify the key pair (the public key and private key) and its certificate in a key/certificate file installed on this printer so that you can use them in the printer, see "[Registering a Key and Its Certificate in the Printer](#)" and register the key pair (the public key and private key) and its certificate in the printer after installing the key/certificate file.

Registering a Key and Its Certificate in the Printer

04L9-0E8

1

Click **[Register Key and Certificate...]**.

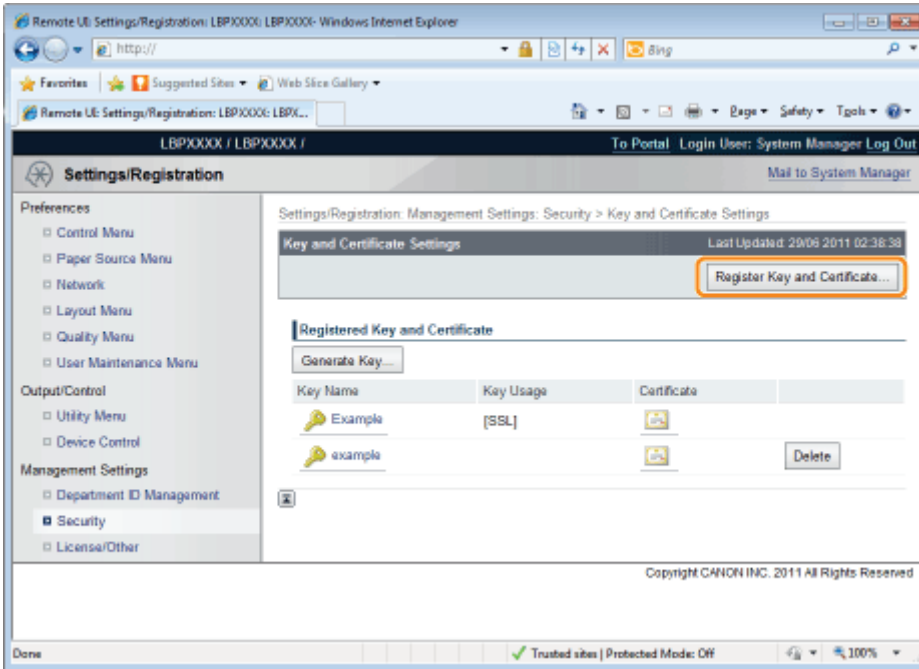

2

Click **[Register...]**.

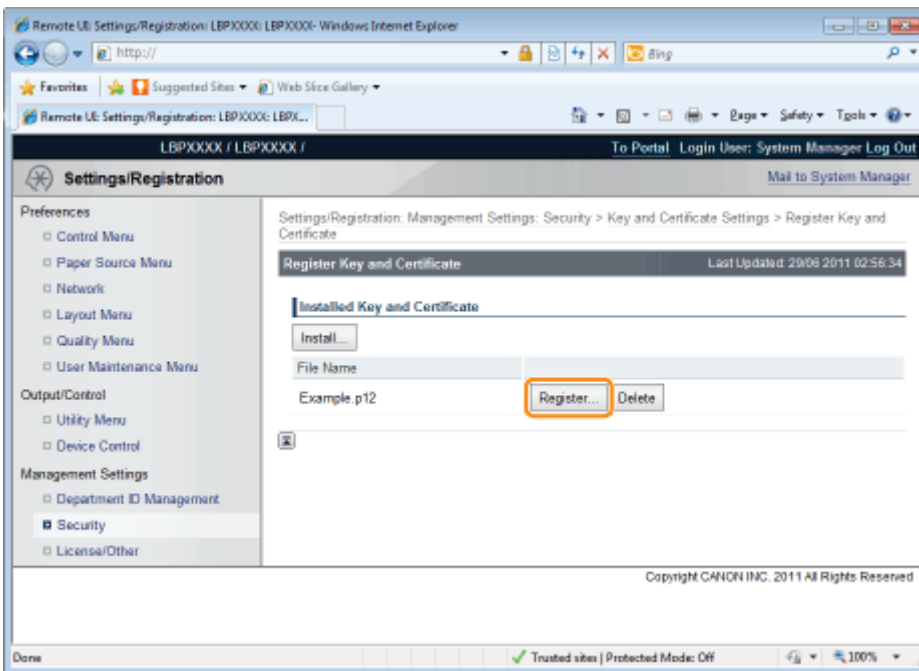

3

Enter the name of the key to be registered.

Up to 24 alphanumeric characters can be entered.

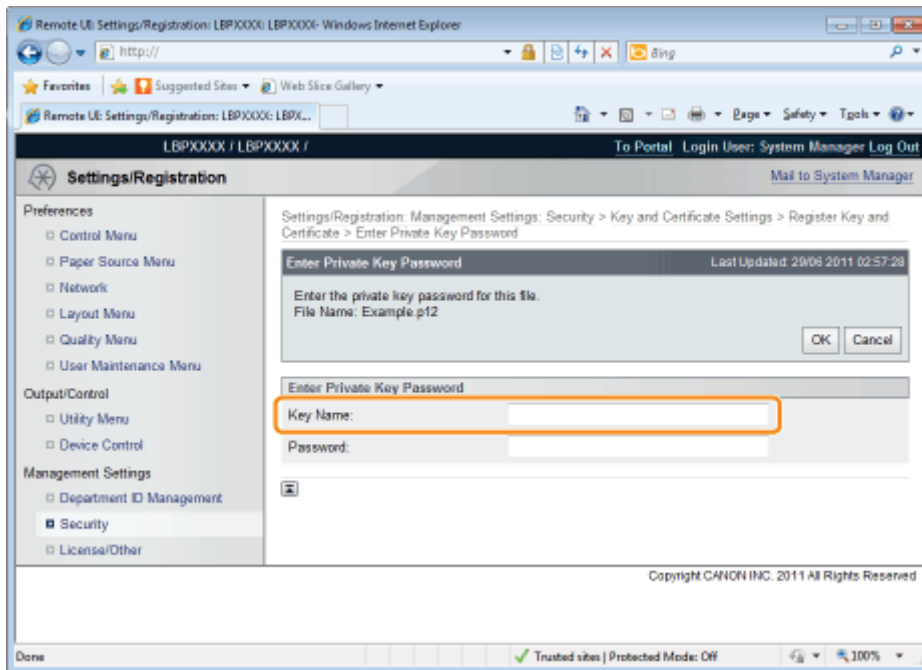

4

Enter the password specified for the private key.

Up to 24 alphanumeric characters can be entered.

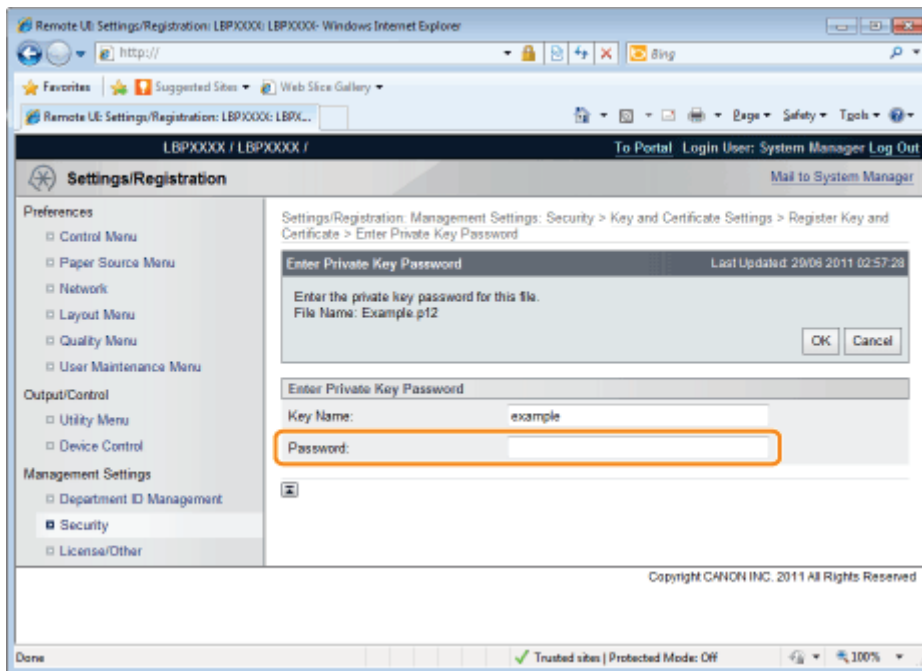

5

Click [OK].

→ The key and certificate registration starts.

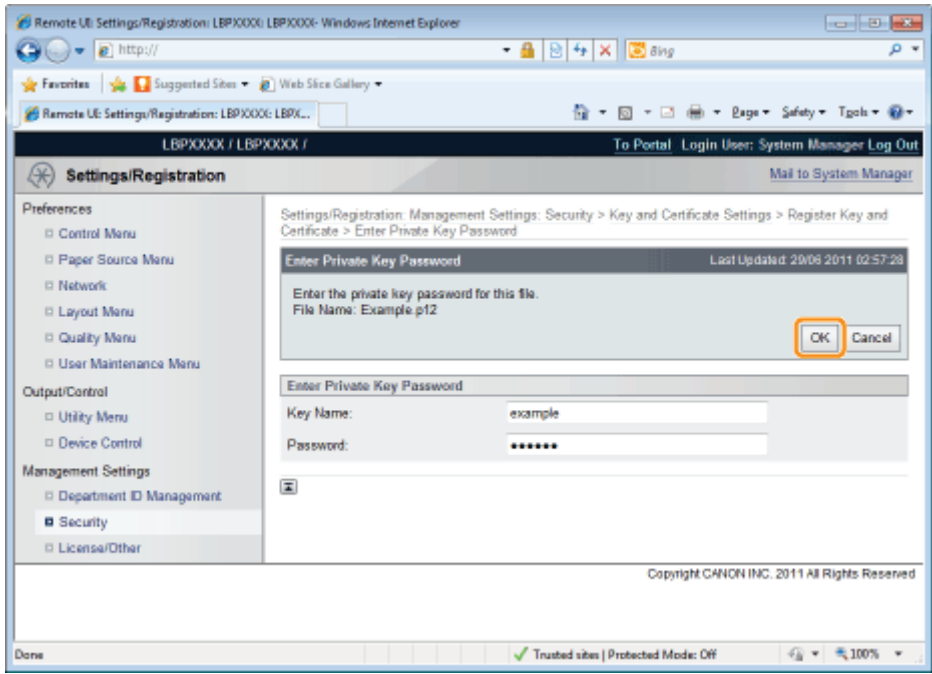

Checking a Certificate

04L9-0E9

1

Click the icon of the certificate to be confirmed.

[] is displayed only when a certificate has been issued for the created key.

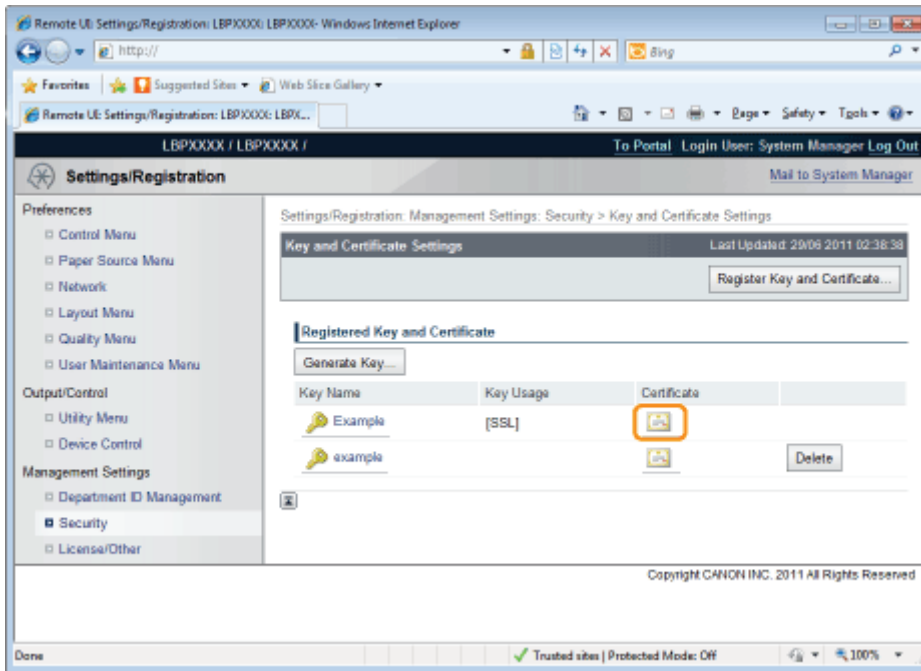

2

If you want to verify the certificate, click [Certificate Verification].

→ The verification result is displayed.

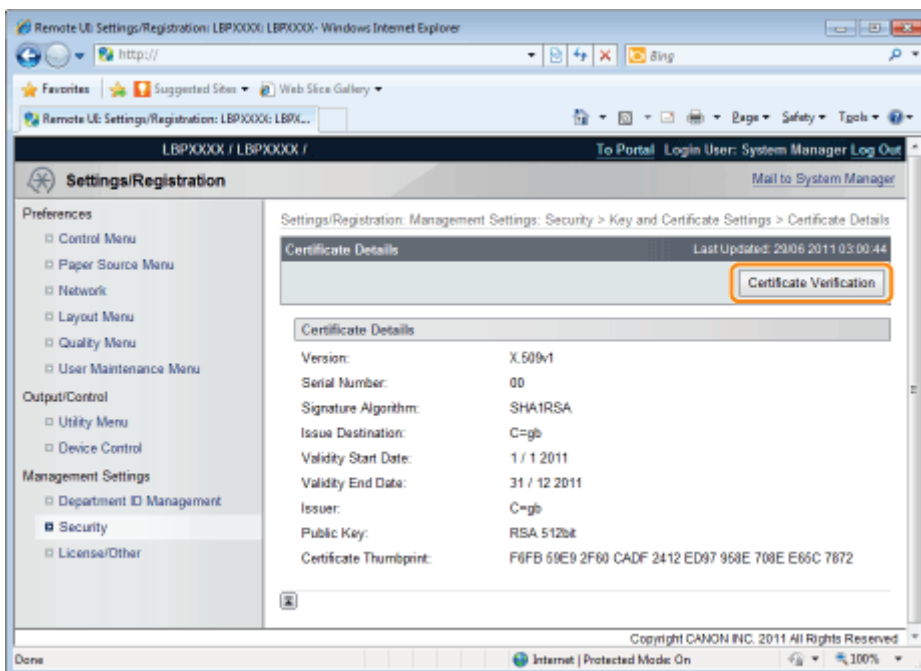

Check the verification result, and then click [Back to Certificate Details].

Deleting a Key and Its Certificate

04L9-0EA

1

Click **[Delete]** for the key and its certificate that you want to erase.

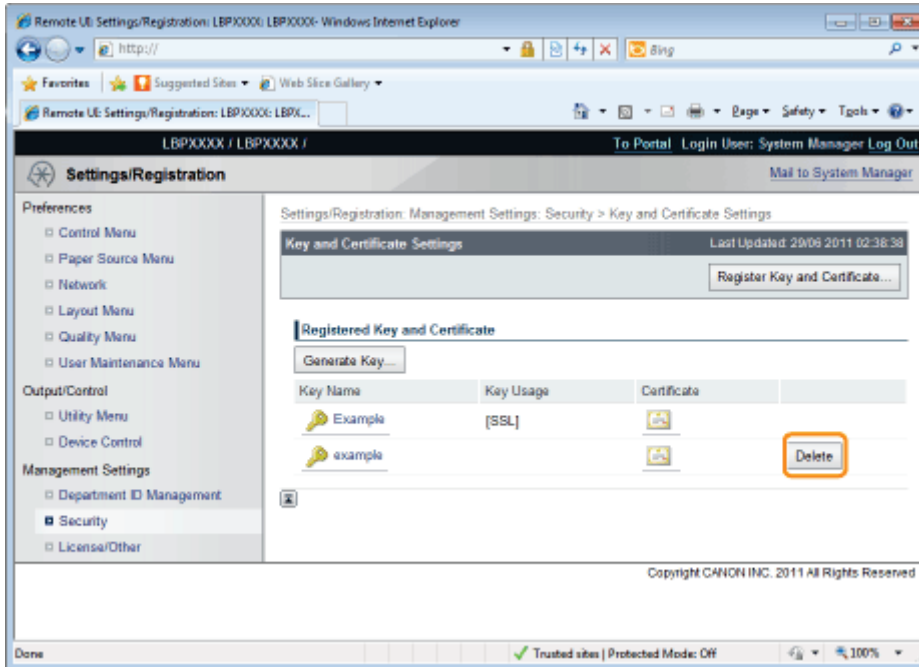

NOTE

About **[Delete]**

- **[Delete]** is displayed only when the key is not specified as the default key.

2

Click **[OK]**.

→ The selected key and its certificate are deleted.

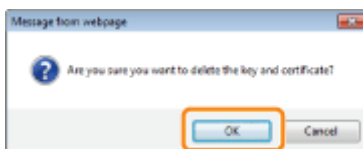

Setting CA Certificates

04L9-0EC

Set CA certificates needed by the server in order to use SSL server communication.

See the following sections.

- ❖ "Displaying the [CA Certificate Settings] Page in the Remote UI"
- ❖ "Installing CA Certificate Files on the Printer"
- ❖ "Registering CA Certificates in the Printer"
- ❖ "Checking CA Certificates"
- ❖ "Deleting CA Certificates"

IMPORTANT

Number of CA Certificates that can be Registered/Installed

Registered: 4

Installed: 2

If you cannot register or install one, delete unnecessary keys and certificates.

Displaying the [CA Certificate Settings] Page in the Remote UI

04L9-0EE

1

Start the Remote UI, and then log in as Administrator.

➤ "Starting the Remote UI"

2

Click [Settings/Registration].

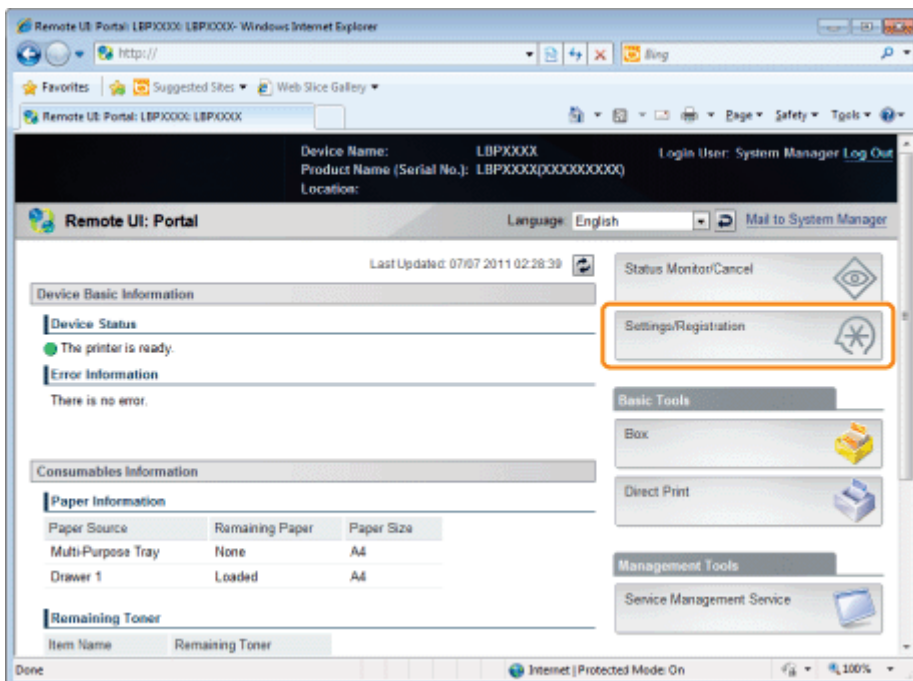

3

Select [Security] from the [Management Settings] menu.

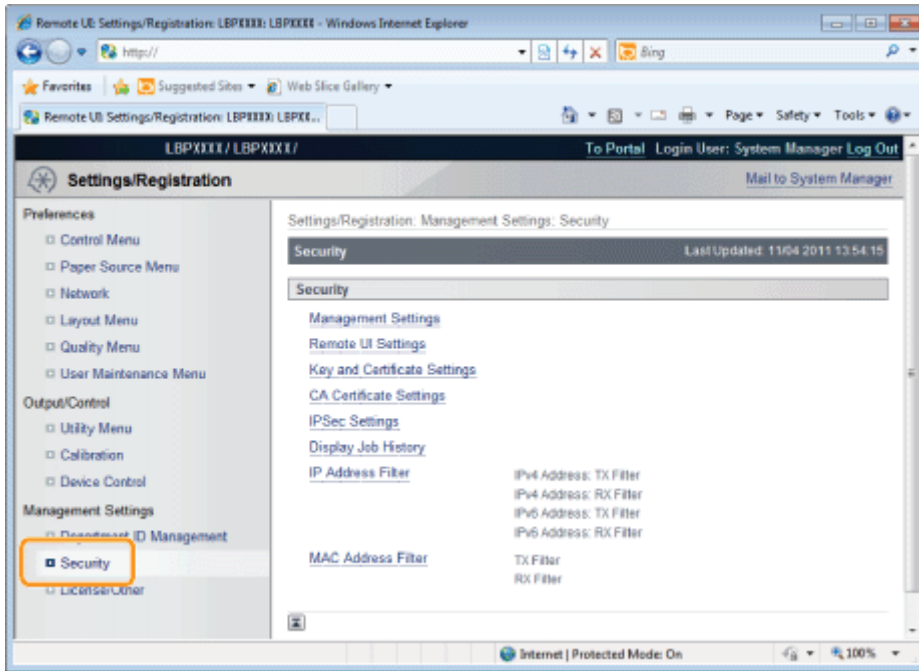

4

Click [CA Certificate Settings].

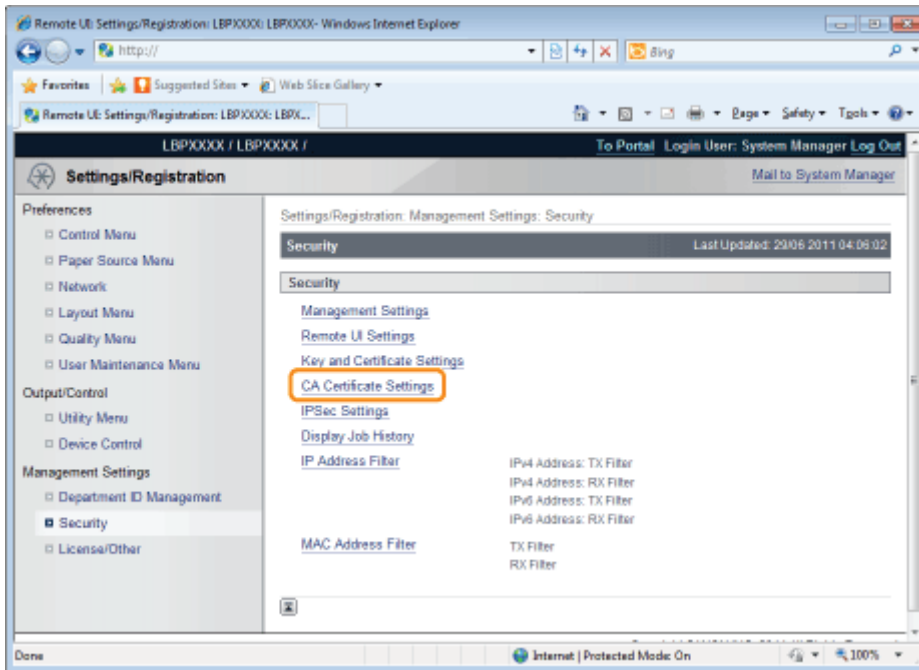

Installing CA Certificate Files on the Printer

04L9-0EF

1

Click **[Register CA Certificate...]**.

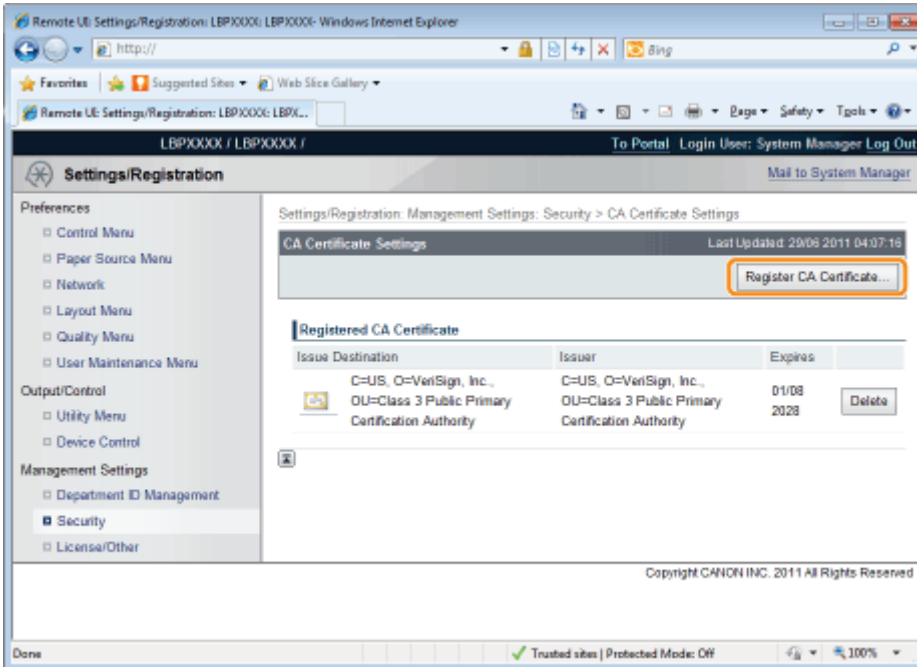

2

Click **[Install...]**.

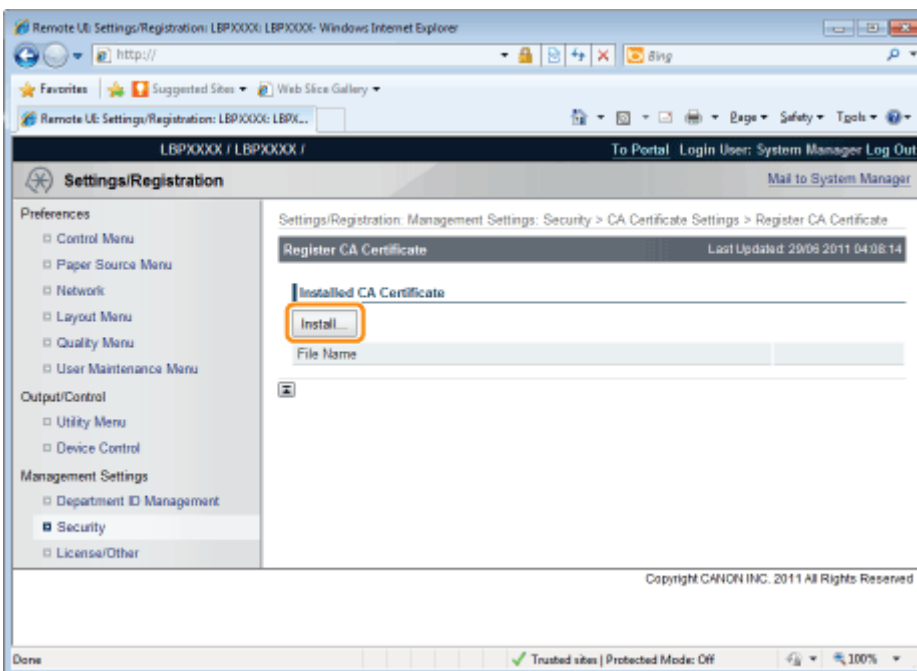

3

Specify the location of the CA certificate file.

Either select the CA certificate file by clicking [Browse...], or enter the location where CA certificate file is stored.

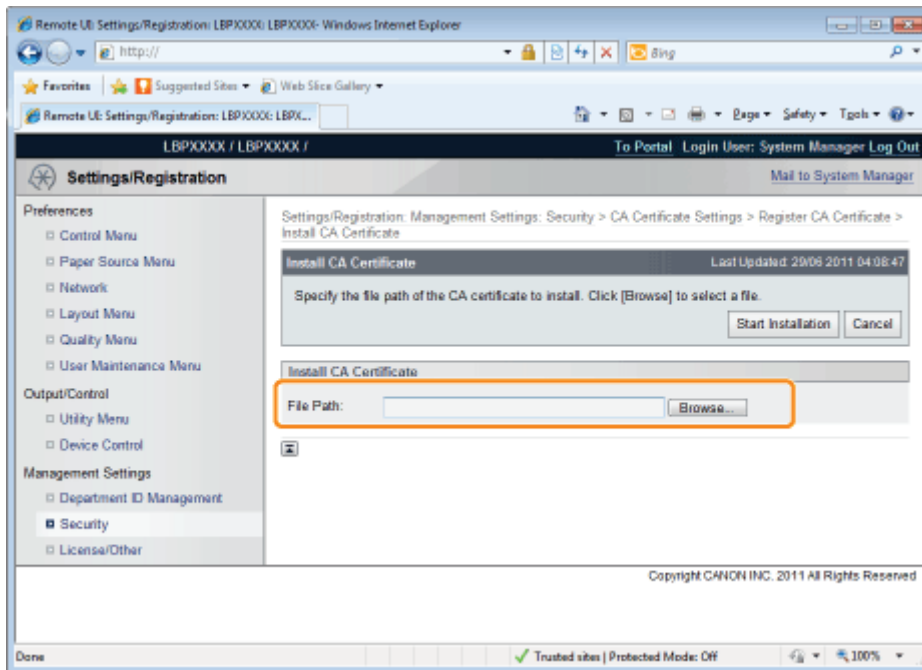

4

Click [Start Installation].

→ The CA file installation starts.

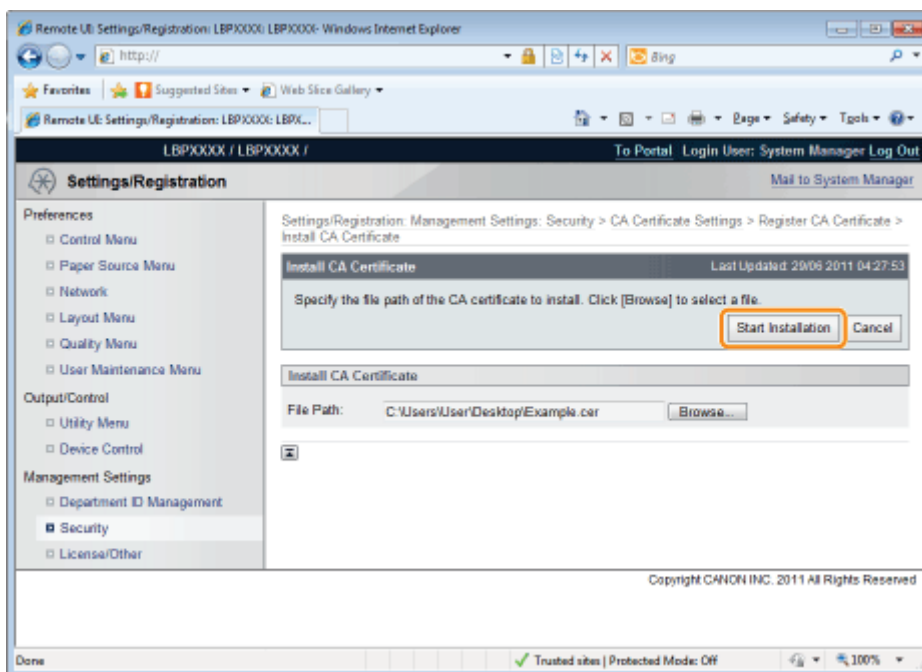

To enable the printer to use the CA certificate installed on the printer, after the CA certificate installation is complete, refer to "[Registering CA Certificates in the Printer](#)" and register the CA certificate in the printer.

Registering CA Certificates in the Printer

04L9-0EH

1

Click [Register CA Certificate...].

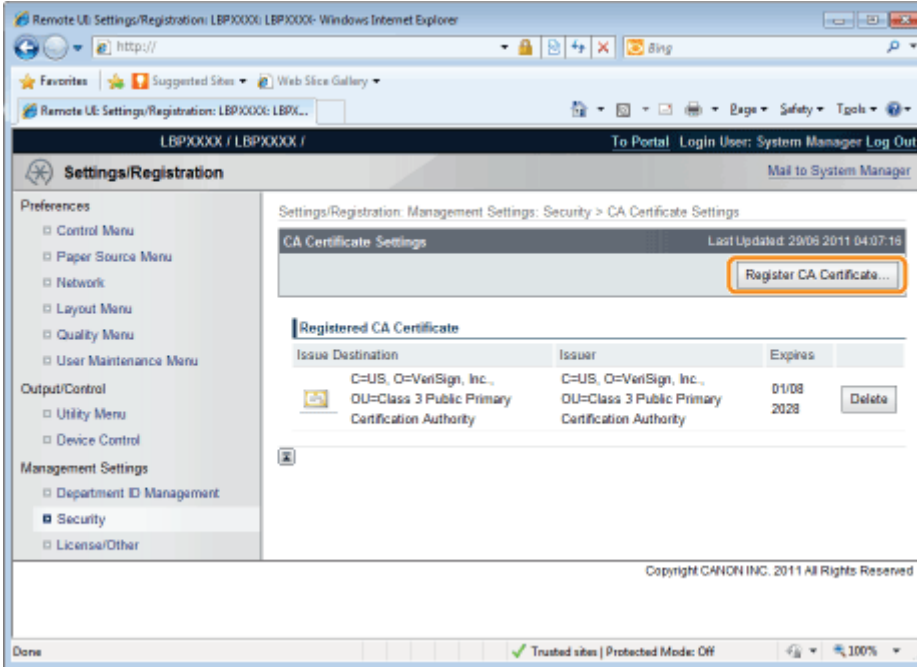

2

Click [Register].

→ The CA file registration begins.

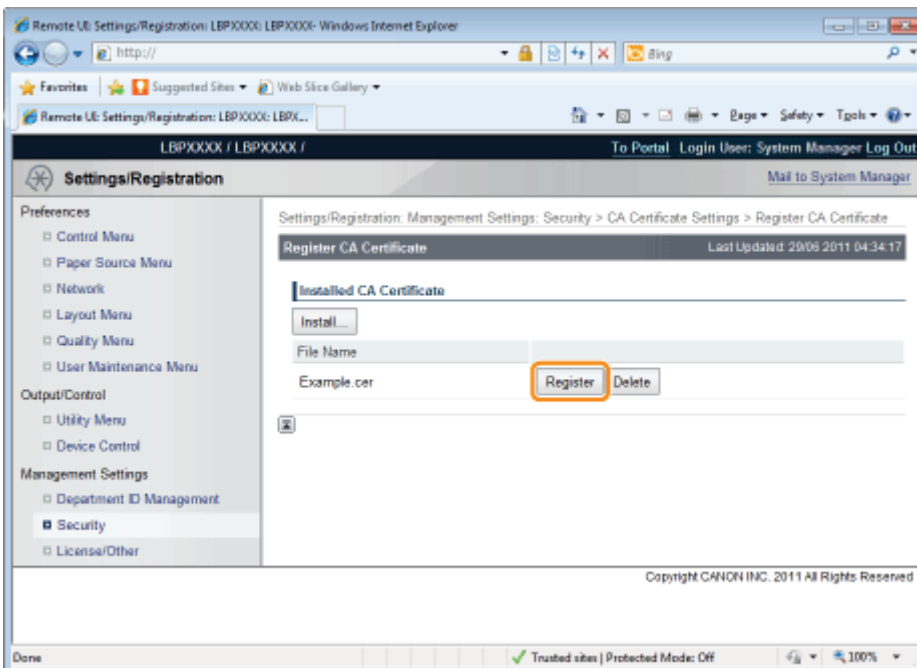

Checking CA Certificates

04L9-0EJ

1

Click the icon of the CA certificate to be confirmed.

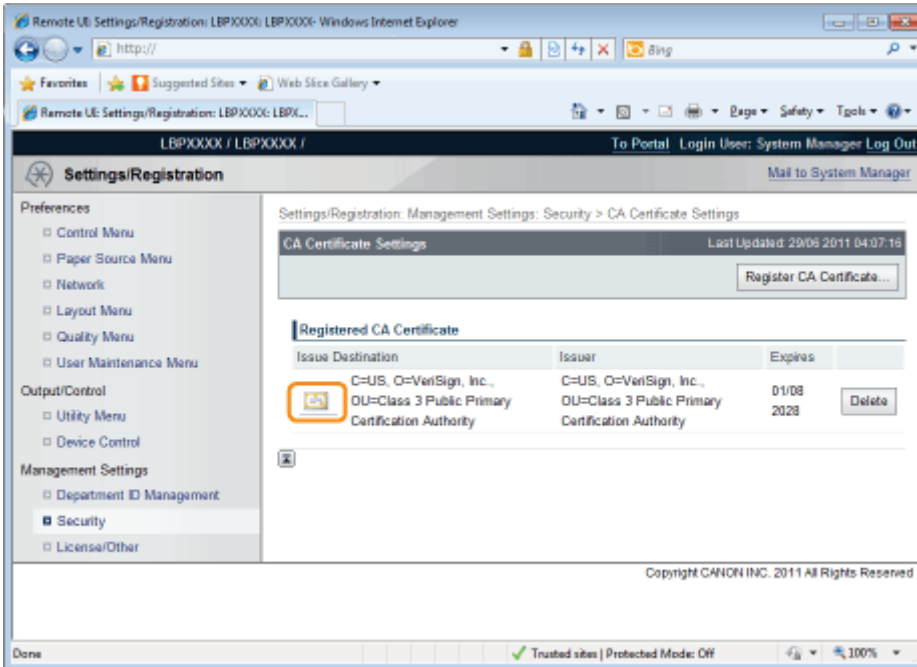

2

If you want to verify the certificate, click [Certificate Verification].

→ The verification result is displayed.

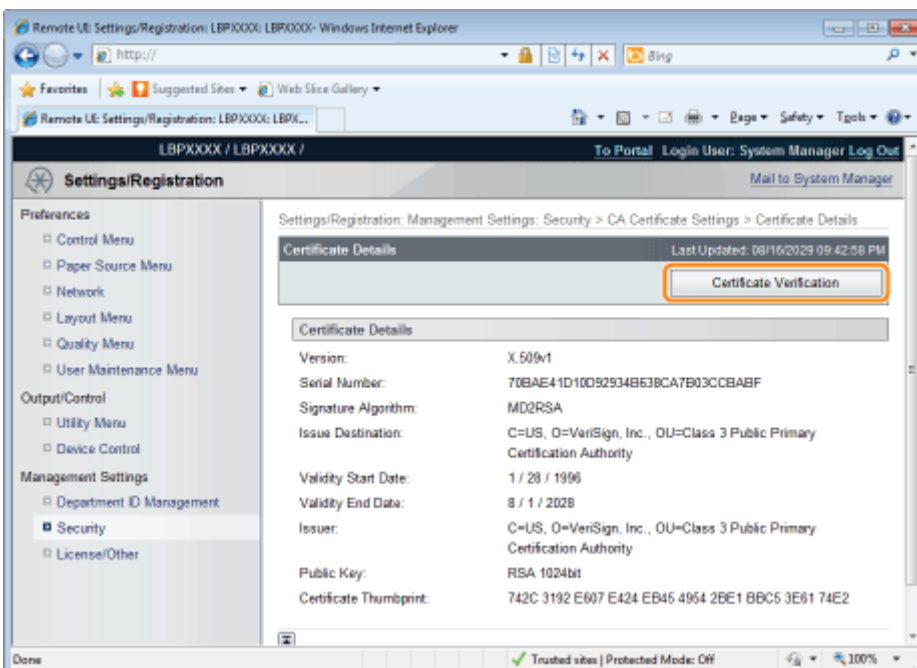

Check the verification result, and then click [Back to Certificate Details].

Deleting CA Certificates

04L9-0EK

1

Click [Delete].

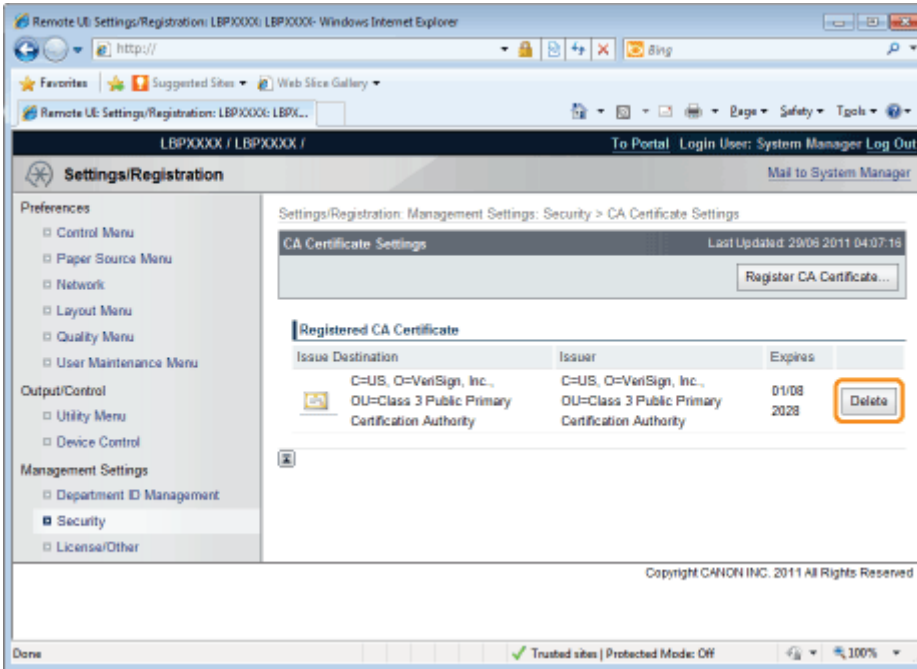

2

Click [OK].

→ The CA certificate is deleted.

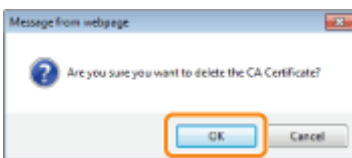

Setting the SSL Encryption Communication Function

04L9-0EL

Specify settings in order to use the SSL encryption communication function with this printer.

See the following sections.

- ["Selecting Keys and Certificates"](#)
- ["Changing the Remote UI Settings"](#)

NOTE

SSL encrypted communication function

This is a function that enables exchange of encrypted data between this printer and a computer when performing IPP printing in which data is printed via a network or when using the Remote UI in which you manage the printer with the Web browser.

Using the SSL encrypted communication function achieves safer printing environments by preventing theft and falsification of data.

To perform SSL encrypted communication

A key pair (the public key for encryption and private key for decryption) is required.

Registering the key pair in this printer and opening the public key to the users allows you to perform the following.

- The users can encrypt data to send to the printer.
- Only this printer can decrypt the encrypted data with the private key.

In this printer, a certificate is also created when a key pair is created. The users can check information about the key with the certificate.

Selecting Keys and Certificates

04L9-0ER

Select keys and certificates used by SSL encrypted communication functions.

NOTE

When Selecting Keys and Certificates

A key and certificate need to be generated for encrypted SSL traffic. For more information, see "[Setting Keys and Certificates](#)."

About [Default Key Settings]

- [Default Key Settings] is only displayed when the key is not specified as use key.
- To prevent keys in use from being changed, [Default Key Settings] is not displayed in the following cases.
 - [Use SSL] under [Remote UI Settings] is set to ON.
 - [SSL] under [TCP/IP Settings] is set to On for IPP printing.

If you want to set the key as use key, first disable the above settings and then set the key as use key.

1

Start the Remote UI, and then log in as Administrator.

❖ "Starting the Remote UI"

2

Click [Settings/Registration].

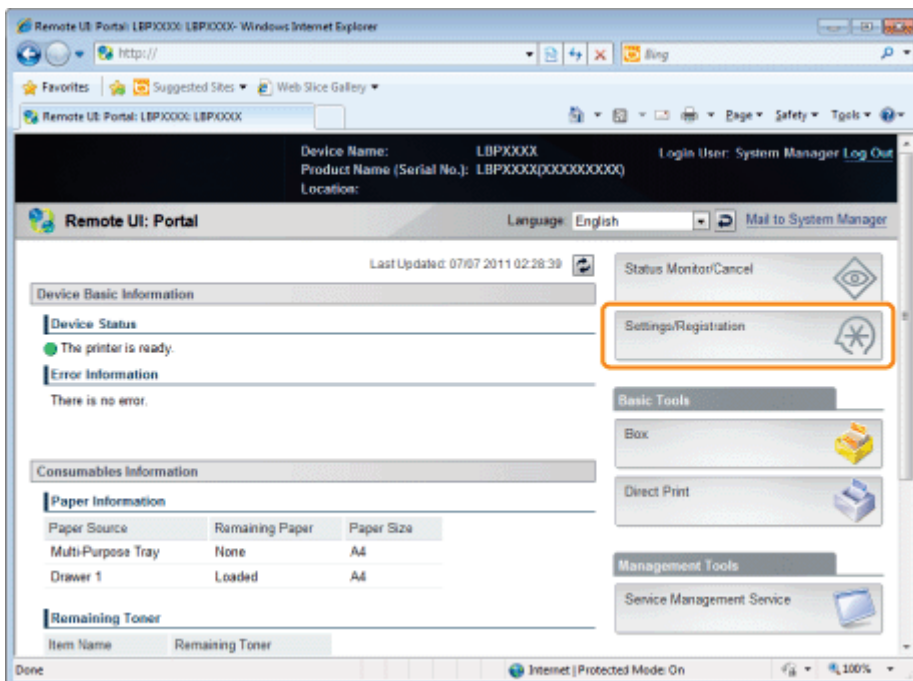

3

Select [Network] from the [Preferences] menu.

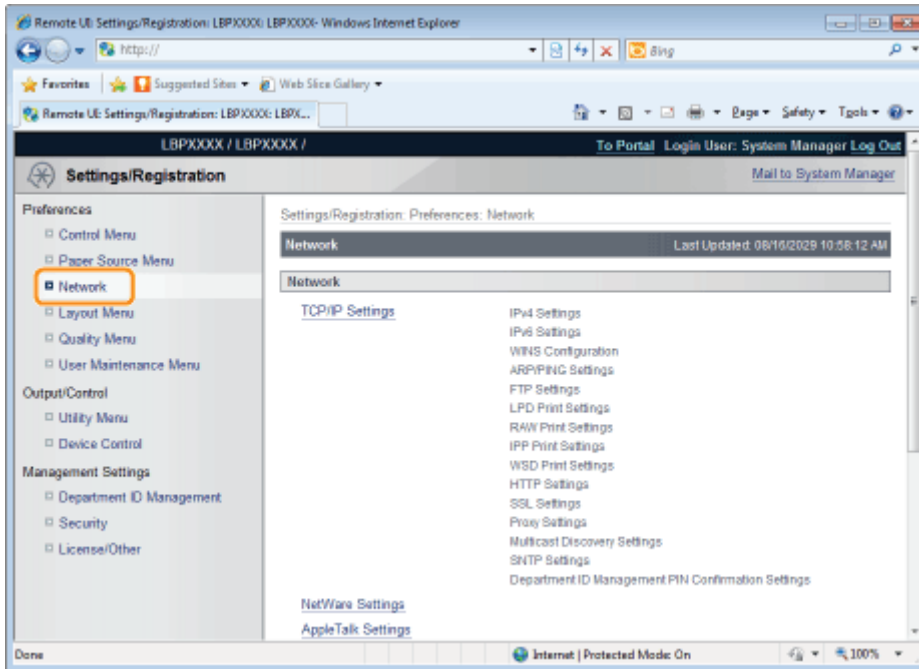

4

Click [TCP/IP Settings].

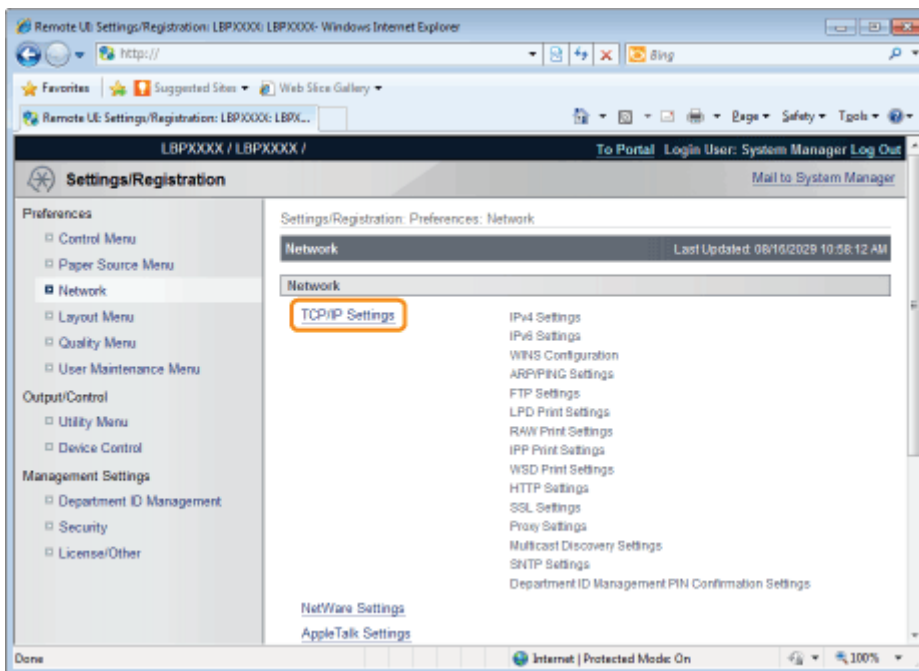

5

Click [Key and Certificate...] under [SSL Settings].

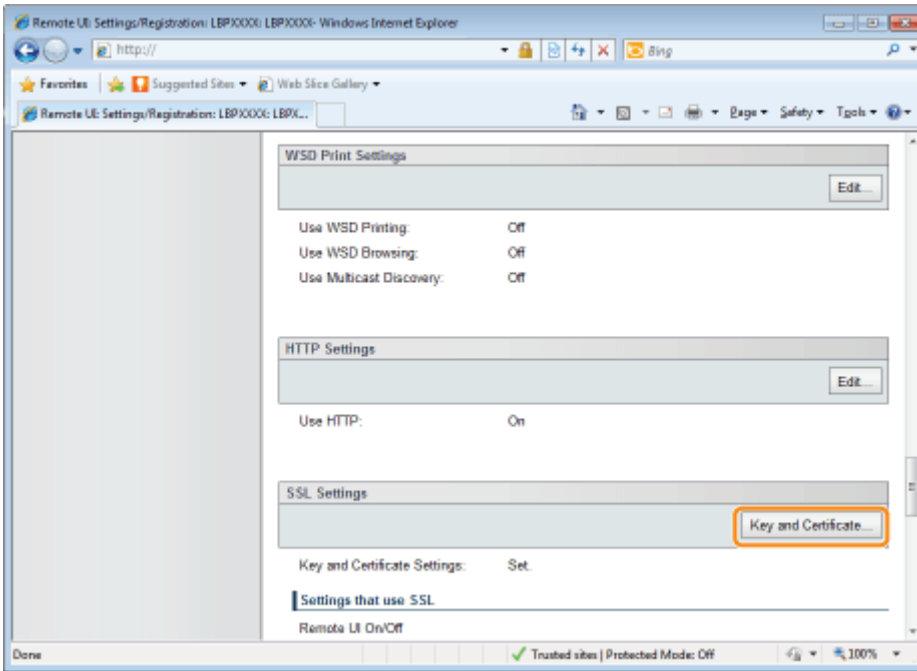

6

Select the key to use, and then click [Default Key Settings].

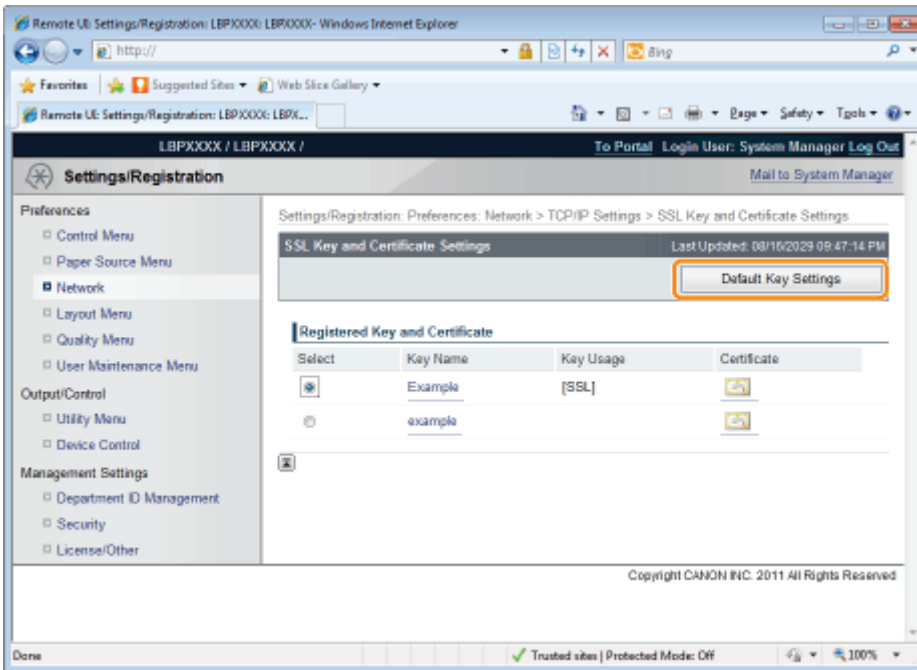

Changing the Remote UI Settings

04L9-0ES

Specify whether the SSL encrypted communication function should be used for the Remote UI.

1

Start the Remote UI, and then log in as Administrator.

❖ "Starting the Remote UI"

2

Click [Settings/Registration].

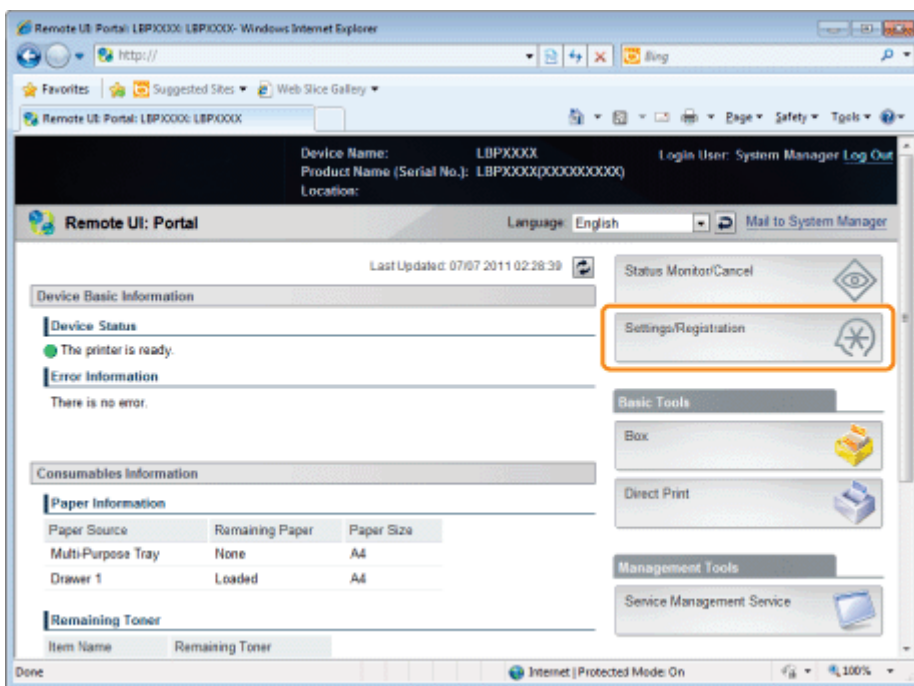

3

Select [Security] from the [Management Settings] menu.

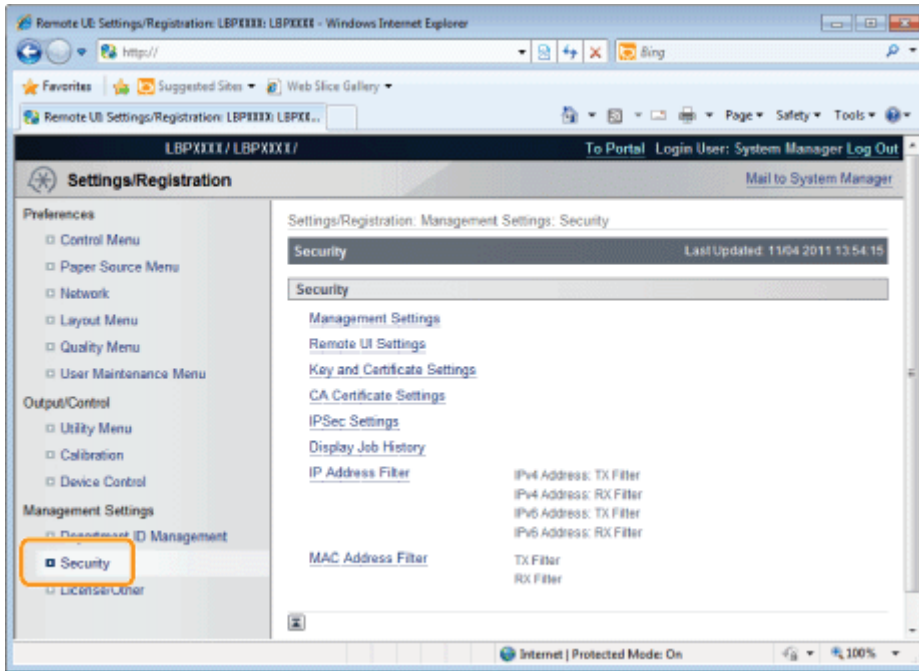

4

Click [Remote UI Settings].

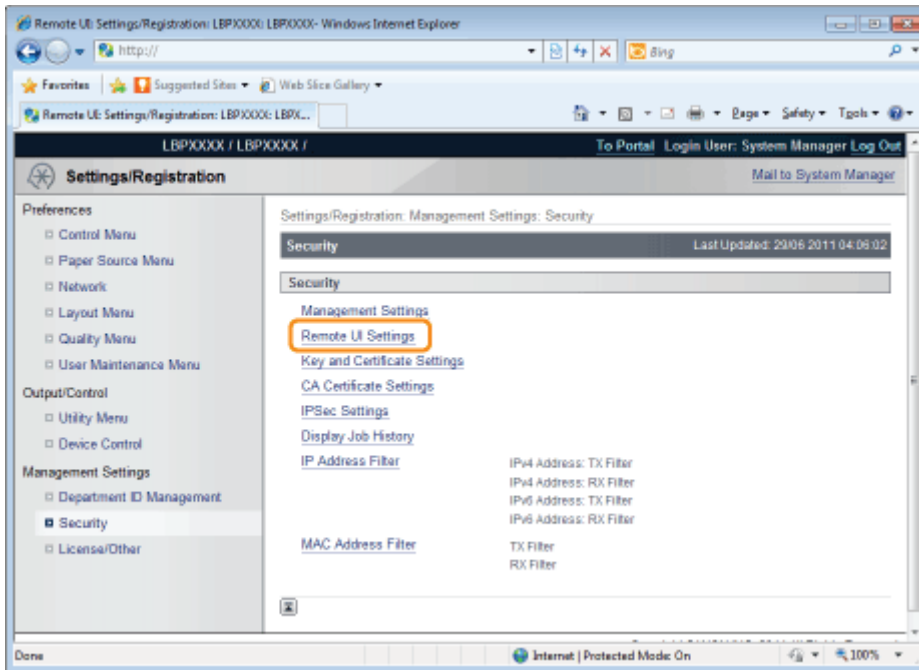

5

Click [Edit...].

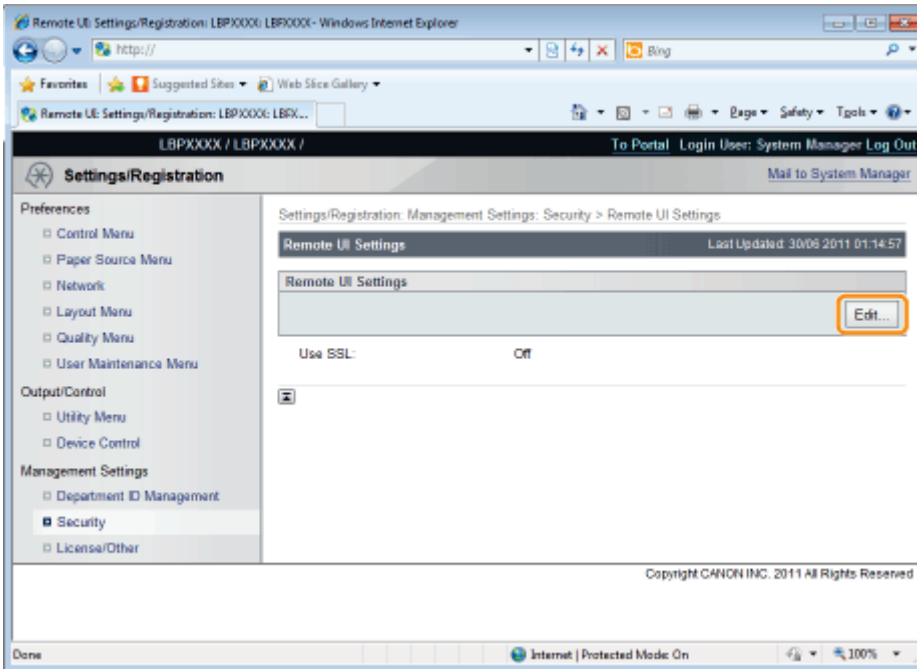

6

Change the Remote UI settings.

- (1) Select the [Use SSL] check box.
 - ↑ If you clear the check box, the remote UI cannot use SSL encrypted communication.
- (2) Click [OK].

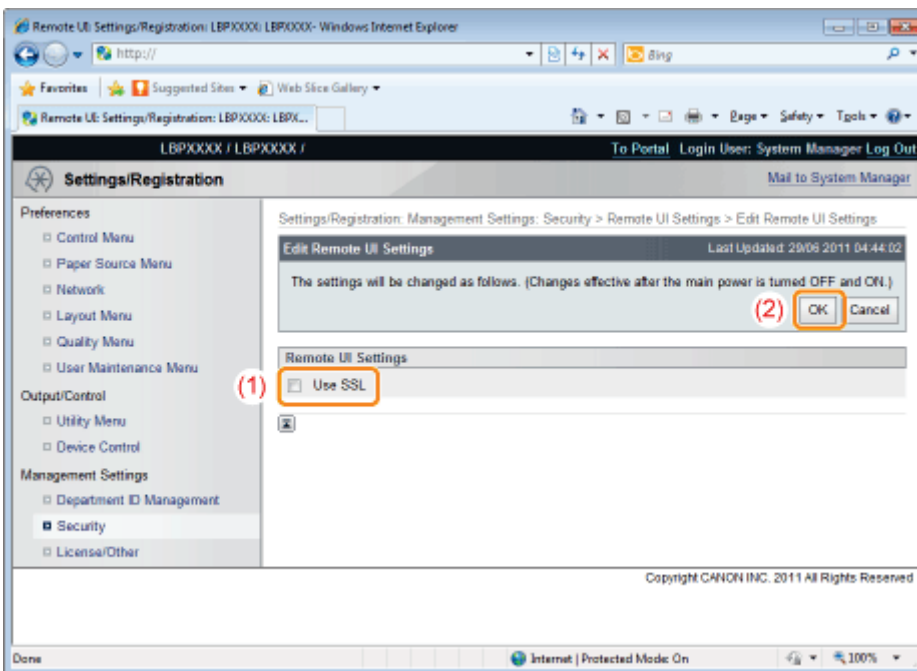

IMPORTANT

If you cannot set [Use SSL]

When a key is not selected for SSL, [Use SSL] cannot be checked.

- [Setting Keys and Certificates](#)
- [Selecting Keys and Certificates](#)

7

Perform a hard reset or restart the printer.

→ After performing a hard reset or restarting the printer, the settings are effective.

NOTE

To perform a hard reset

You can perform a hard reset using the following procedure.

1. Click [Settings/Registration].
2. Select [Device Control] from the [Output/Control] menu.
3. Select [Hard Reset], and then click [Execute].

Setting the IPSec Encryption Communication Function (LBP6680x Only)

04L9-0EU

Specify the settings for using IPSec encryption with the printer.

See the following sections, depending on the items you wish to set.

- Registering/Editing Security Policies
In order to use the IPSec encryption communication function, it is necessary to set a security policy in advance.
 - [Displaying the \[Key and Certificate Settings\] Page in the Remote UI](#)
 - [Adding a New Security Policy](#)
 - [Editing Security Policies](#)
- Enabling and Disabling IPSec Encryption Communication Function Settings
 - [Displaying the \[Key and Certificate Settings\] Page in the Remote UI](#)
 - [Enabling IPSec Encryption Communication](#)

NOTE

IPSec Encryption Communication

IPSec is a protocol that maintains security by protecting IP packets transmitted over the IP network from threats such as theft, falsification, spoofing. Its advantage is that it can be used to add a security function to the basic Internet Protocol (IP) without being dependent on software or network configuration.

Communication Mode

Of the IPSec communication modes, the printer supports only the transport mode. Certificates and encryption can only be applied to the data parts of IP packets.

IMPORTANT

Packets that are not applied by IPSec encrypted communication

The following packets are not applied by IPSec encrypted communication.

- IKE (IPv4/IPv6)
 - UDP port number: 500
- Loopback address
 - IPv4 address: 127.0.0.1
 - IPv6 address: ::1
- Multicast address
 - IPv4 address: 244.0.0.0 /4
 - IPv6 address: FF00:: /8
- Broadcast address
 - IPv4 address: 255.255.255.255

Displaying the [IPSec Settings] Page on the Remote UI

04L9-0EW

1

Start the Remote UI, and then log in as Administrator.

➤ "Starting the Remote UI"

2

Click [Settings/Registration].

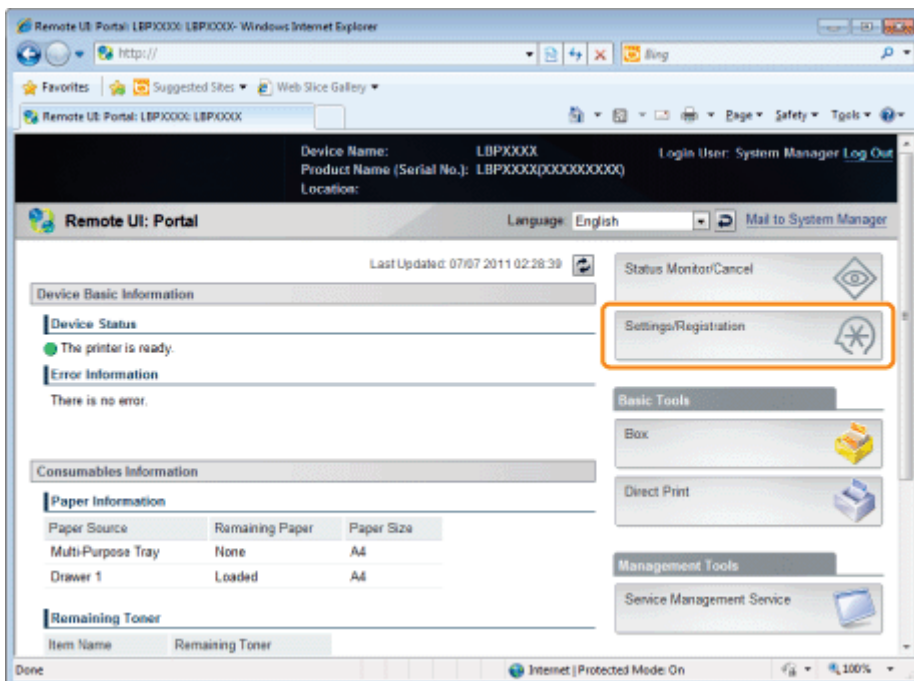

3

Select [Security] from the [Management Settings] menu.

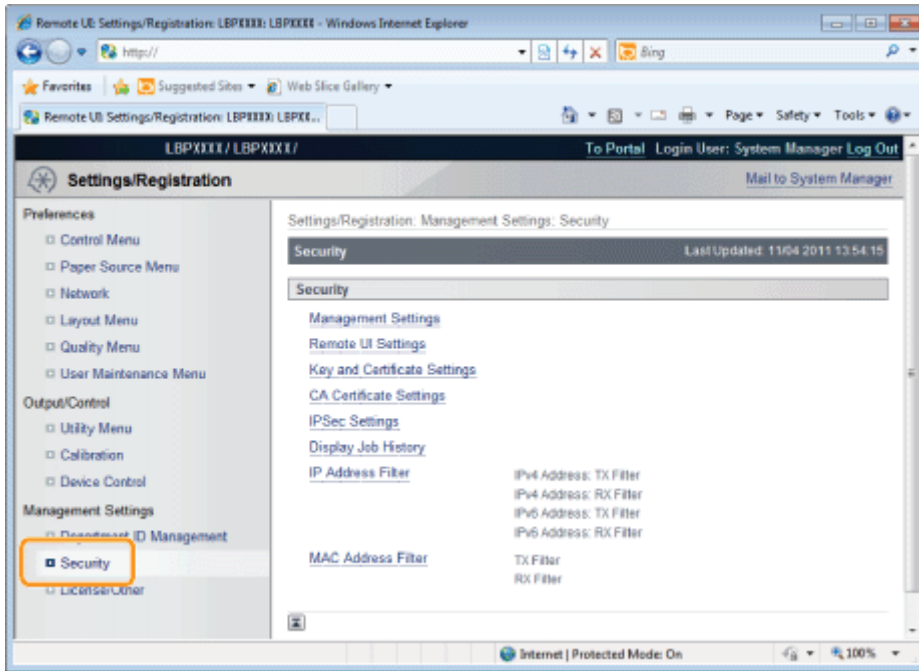

4

Click [IPSec Settings].

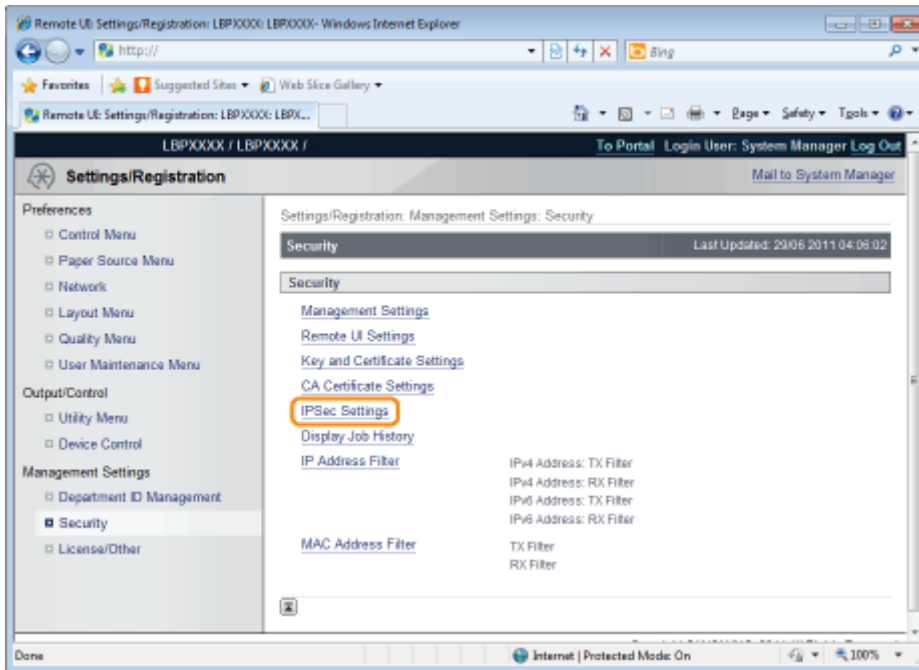

Adding a New Security Policy

04L9-0EX

NOTE

Number of security policies that can be registered

You can register up to 10.

If you cannot register one, delete unnecessary security policies.

1

Click **[IPSec Policy List...]** on the **[IPSec Settings]** page.

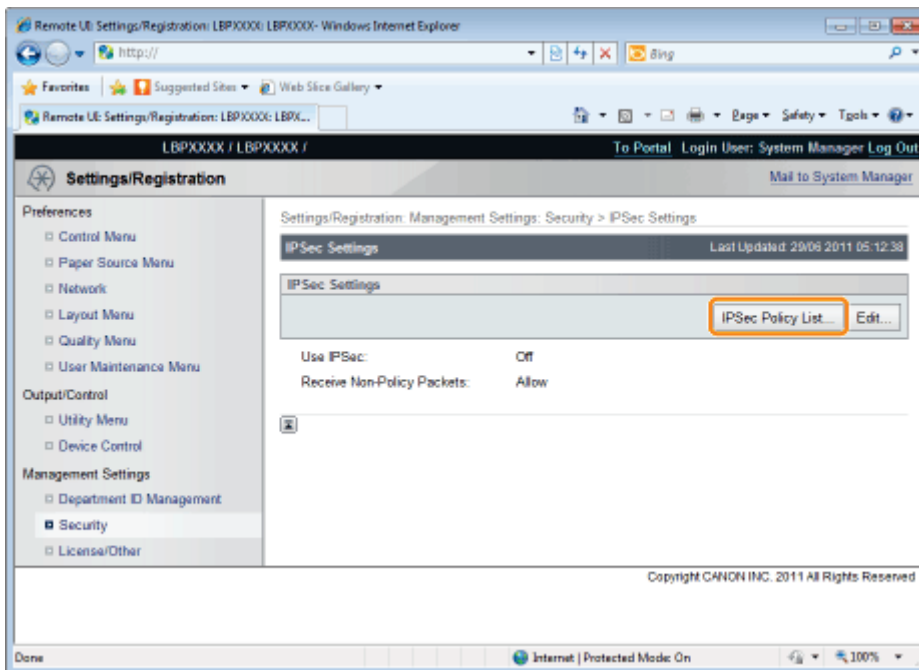

2

Click **[Register IPSec Policy...]**.

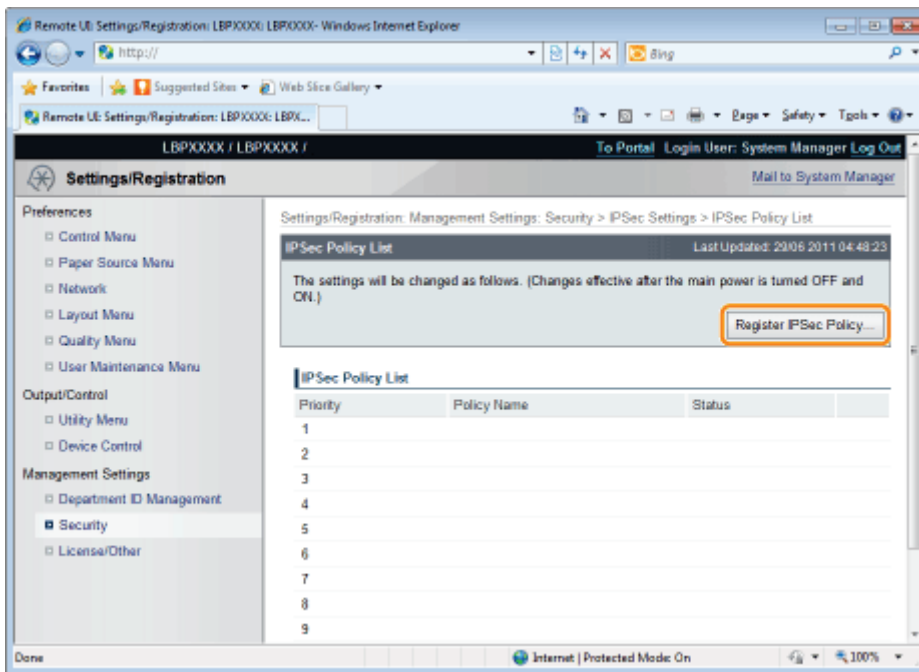

3

Enter the name of the new security policy to be registered.

Up to 24 alphanumeric characters can be entered.

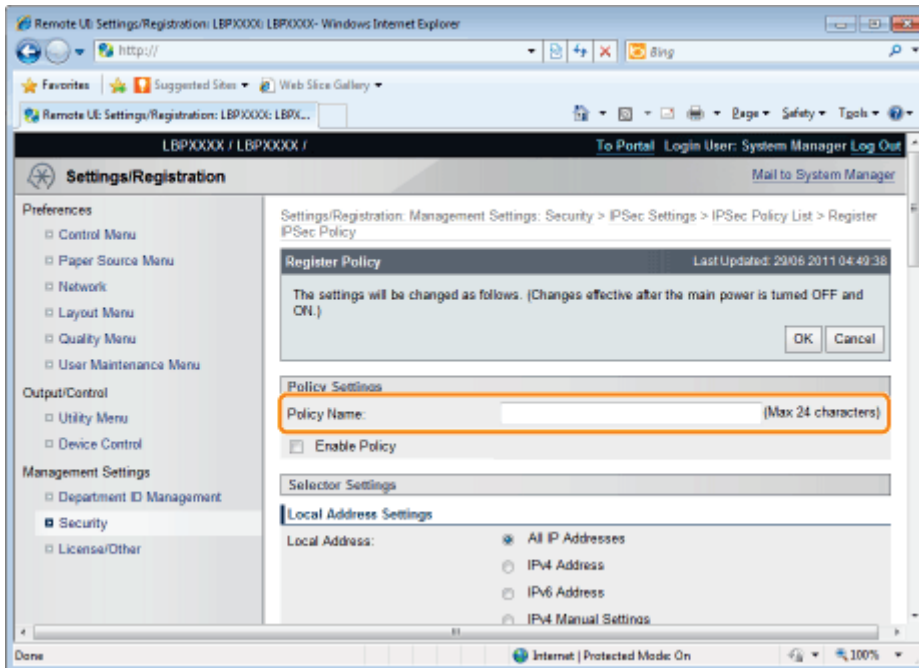

4

Select the [Enable Policy] check box.

† If the check box is cleared, the security policy cannot be used.

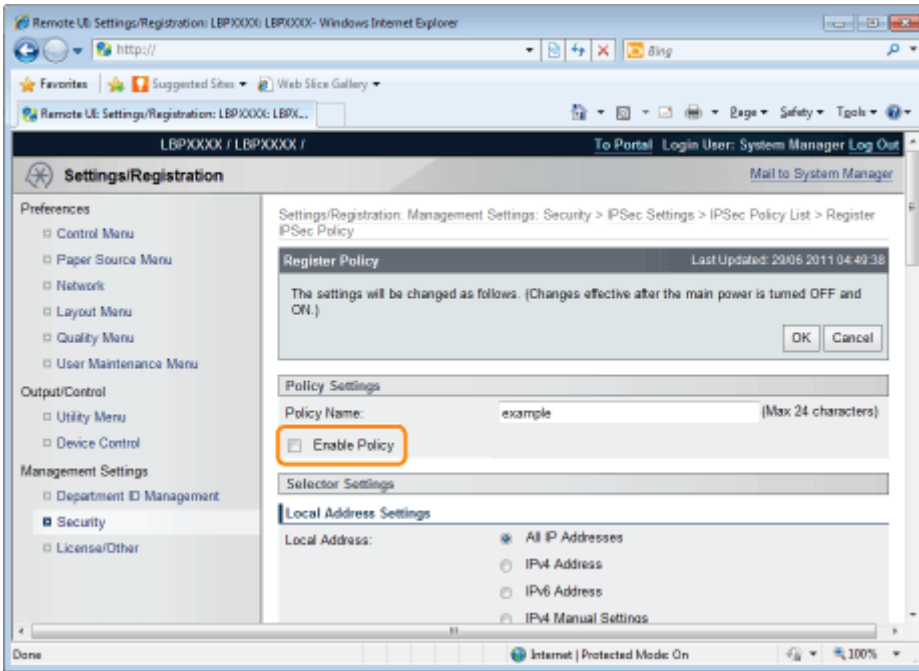

5

Set [Local Address Settings] and [Remote Address Settings].

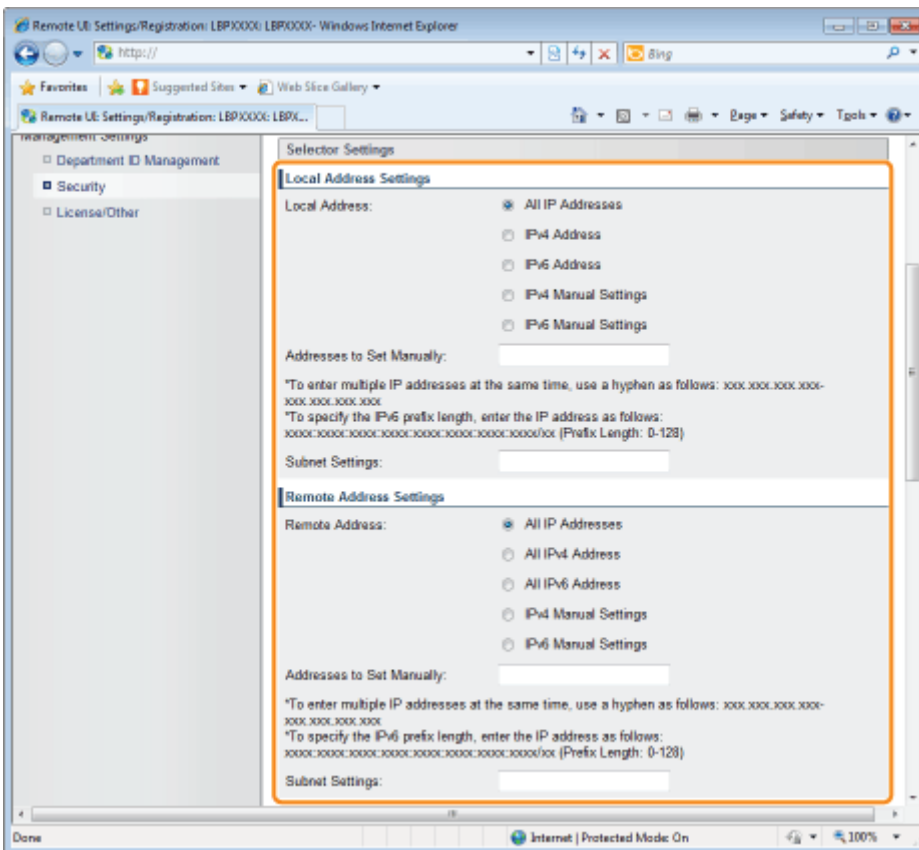

The packets setting the security policy are specified as follows.

	Transmission	Packets Applying the Security Policy
[Local Address]	RX	Packets with "destination IP addresses" that match IP addresses specified here
	TX	Packets with "departure IP addresses" that match IP addresses specified here
	RX	Packets with "departure IP addresses" that match IP addresses specified

[Remote Address]		here
	TX	Packets with "destination IP addresses" that match IP addresses specified here

When [IPv4 Manual Settings]/[IPv6 Manual Settings] is selected

Enter the IP address in the [Addresses to Set Manually] field.

You can enter the IP address in the following way.

IP Address Entry Example	IP Address Entry Method
192.168.0.1-192.168.0.10 fe80::1000-fe80::2000	If you want to enter the IP addresses of consecutive numbers, place "-" (hyphen) between the address of the smallest number and that of the largest number.
192.168.0.0/16 fe80::0000/64	In order to specify the subnet range (prefix length), enter a "/" (slash) after the normal IP address symbol, and then enter another prefix length (maximum 32 for IPv4 and maximum 128 for IPv6).

6

Set [Port Settings].

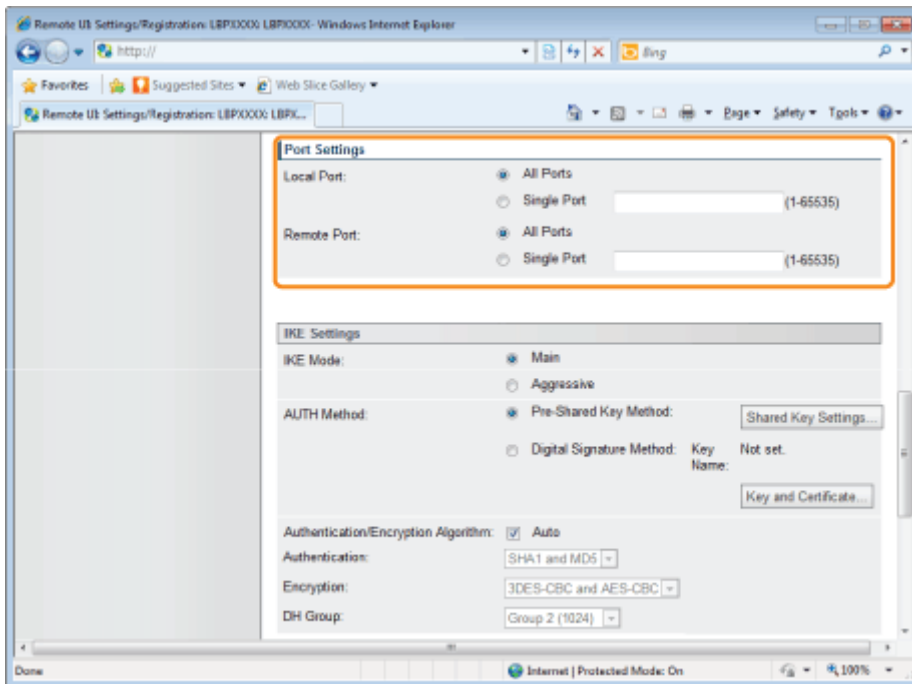

The packets setting the security policy are specified as follows.

	Transmission	Packets Applying the Security Policy
[Local Port]	RX	Packets with "destination ports" that match IP addresses specified here
	TX	Packets with "departure ports" that match IP addresses specified here
[Remote Port]	RX	Packets with "departure ports" that match IP addresses specified here
	TX	Packets with "destination ports" that match IP addresses specified here

If you want to select all ports

Select the [All Ports] check box.

If you want to select a single port

- (1) Select the [Single Port] check box.
- (2) Enter the port number (0 to 65535).

7

Set [IKE Mode] and [AUTH Method] under [IKE Settings].

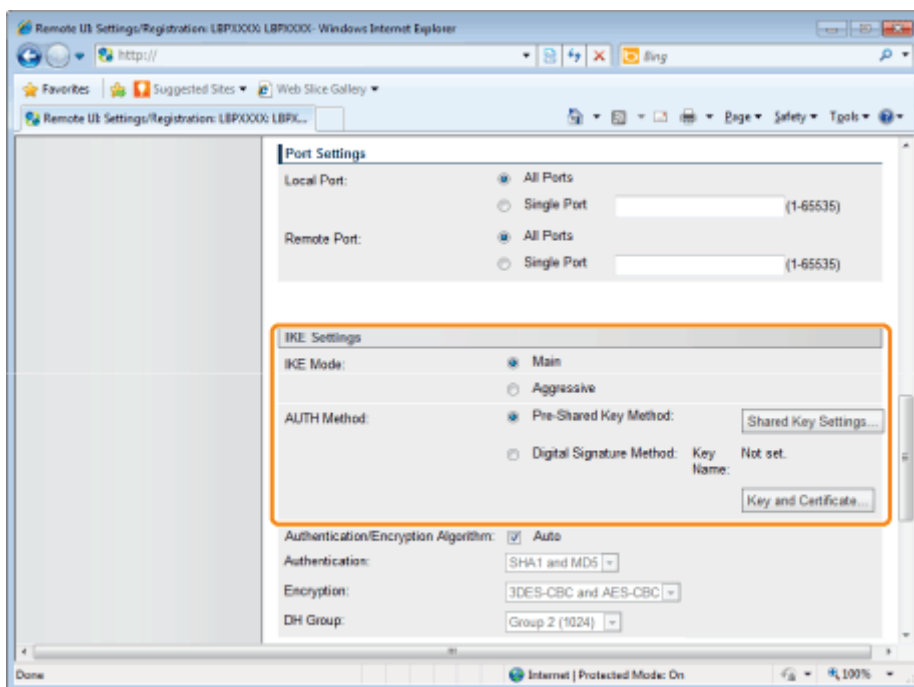

- (1) Select [Main] or [Aggressive] under [IKE Mode].
- (2) Select [AUTH Method].
 - If you want to specify [Pre-Shared Key Method]**
 - a. Select the [Pre-Shared Key Method] check box.
 - b. Click [Shared Key Settings...].
 - c. Enter the name of the shared key (up to 24 characters), and then click [OK].
 - If you want to specify [Digital Signature Method]**
 - a. Select the [Digital Signature Method] check box.
 - b. Click [Key and Certificate...].
 - c. Select the key to use, and then click [Default Key Settings].

NOTE

[AUTH Method] Settings

- In order to set [Pre-Shared Key Method], the SSL encrypted communication function must be enabled.
 - ❖ ["Setting the SSL Encryption Communication Function"](#)
- We recommend that network settings be performed by the network administrator.
 - ❖ ["Setting Keys and Certificates"](#)

8

Set [Authentication/Encryption Algorithm] under [IKE Settings].

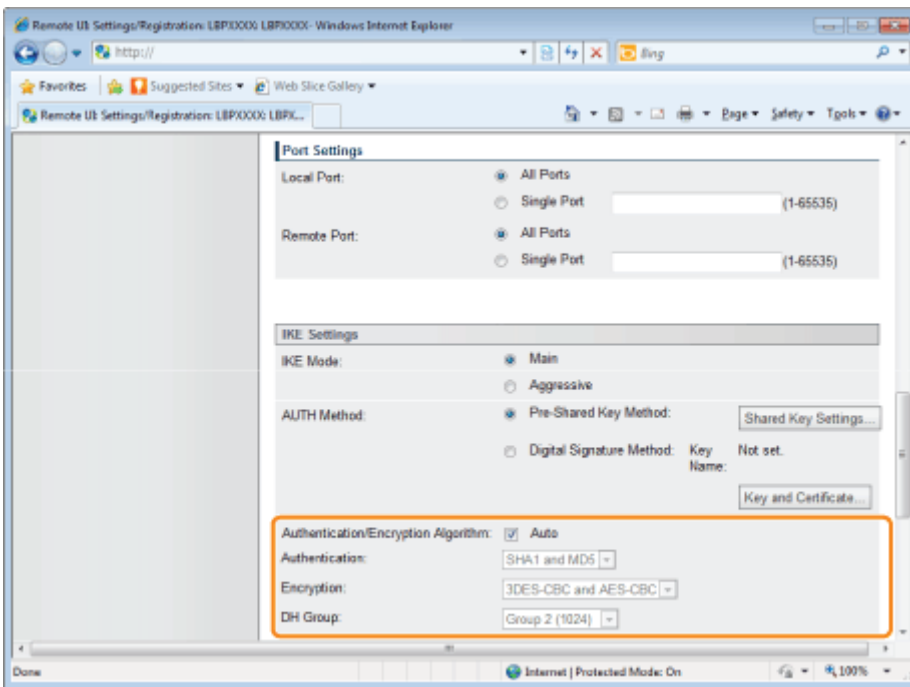

When setting automatically

Select the [Auto] check box.

When setting manually

Set the following items.

[Authentication]	Select the authentication algorithm from [SHA1], [MD5] or [SHA1 and MD5].
[Encryption]	Select the encryption algorithm from [3DES-CBC], [AES-CBC] or [3DES-CBC and AES-CBC].
[DH Group]	Select the Diffie-Hellman group from [Group 1 (768)], [Group 2 (1024)] or [Group 14 (2048)].

9

Set the PFS for [IPSec Network Settings] and [Validity].

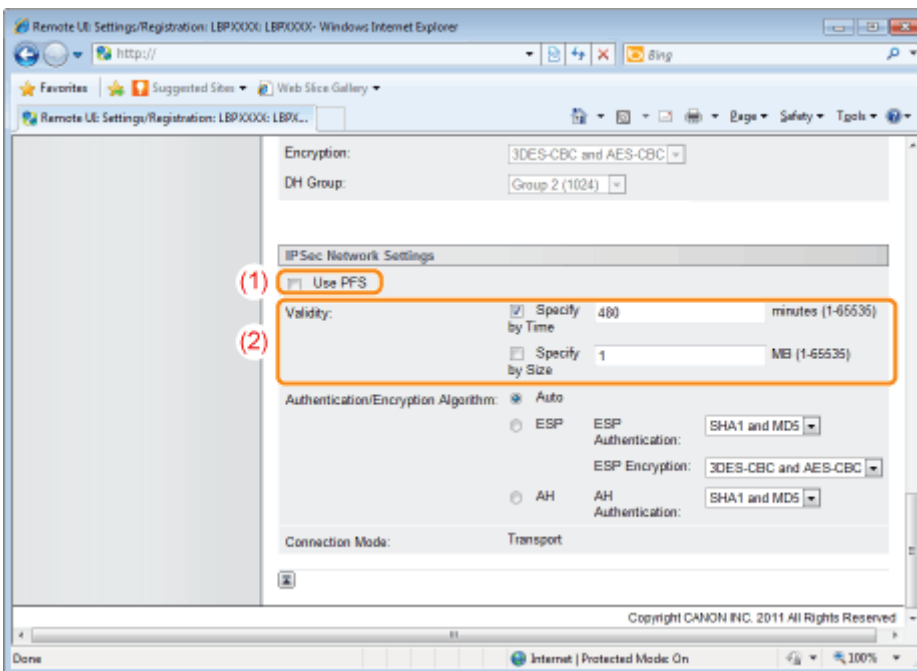

(1) When using PFS, select the [Use PFS] check box.

(2) Set [Validity].

When specifying by time

- a. Select the [Specify by Time] check box.
- b. Enter the time (1 to 65535 minutes).

When specifying by size

- a. Select the [Specify by Size] check box.
- b. Enter the size (1 to 65535 MB).

NOTE

About PFS

If PFS is used, the key generation process becomes complex. Even assuming one key is deciphered, it does not mean that later keys will be deciphered easily.

10

Set [Authentication/Encryption Algorithm] under [IPSec Network Settings].

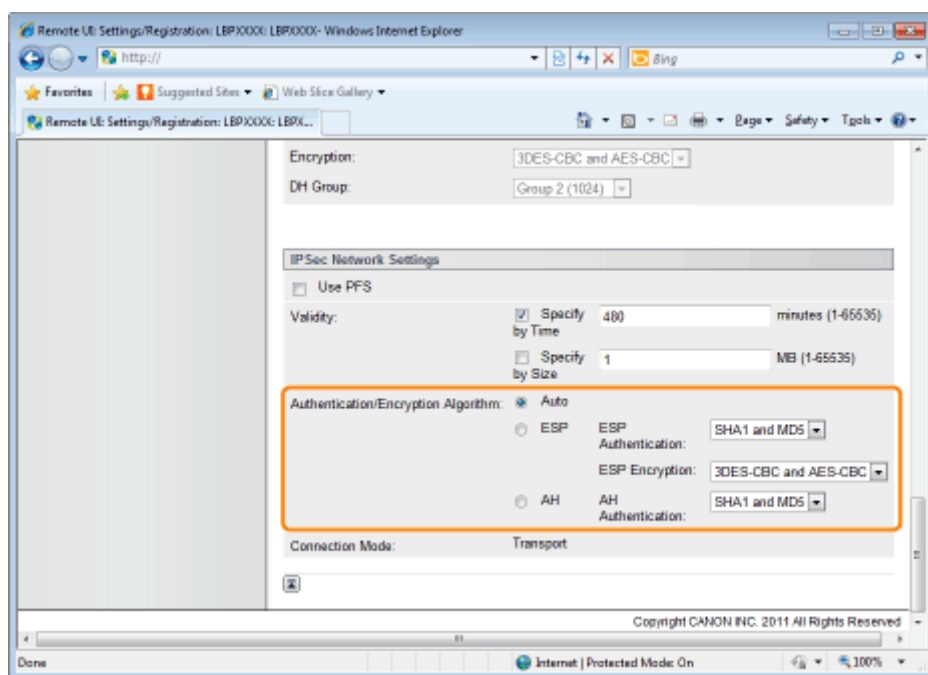

When setting automatically

Select the [Auto] check box.

When setting authentication using ESP protocol

- (1) Select the [ESP] check box.
- (2) Select the authentication algorithm from [SHA1], [MD5], [SHA1 and MD5] or [NULL] under [ESP Authentication].
- (3) Select the encryption algorithm from [3DES-CBC], [AES-CBC], [3DES-CBC and AES-CBC] or [NULL] under [ESP Encryption].

When setting authentication using AH protocol

- (1) Select the [AH] check box.
- (2) Select the authentication algorithm from [SHA1], [MD5] or [SHA1 and MD5] under [AH Authentication].

11

Click [OK].

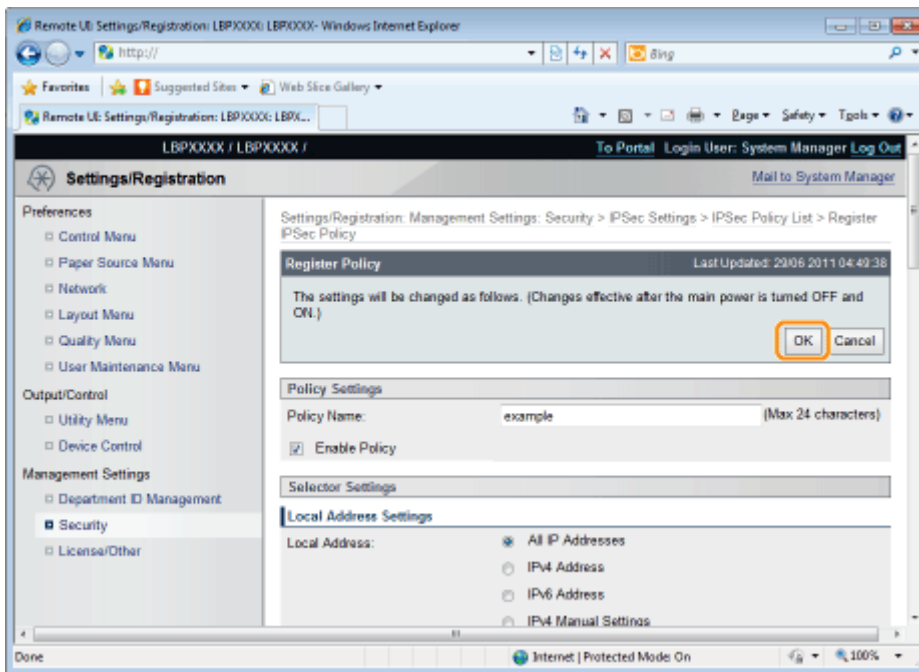

12

Perform a hard reset or restart the printer.

→ After performing a hard reset or restarting the printer, the settings are effective.

NOTE

To perform a hard reset

You can perform a hard reset using the following procedure.

1. Click [Settings/Registration].
2. Select [Device Control] from the [Output/Control] menu.
3. Select [Hard Reset], and then click [Execute].

Editing Security Policies

04L9-0EY

1

Click [IPSec Policy List...] on the [IPSec Settings] page.

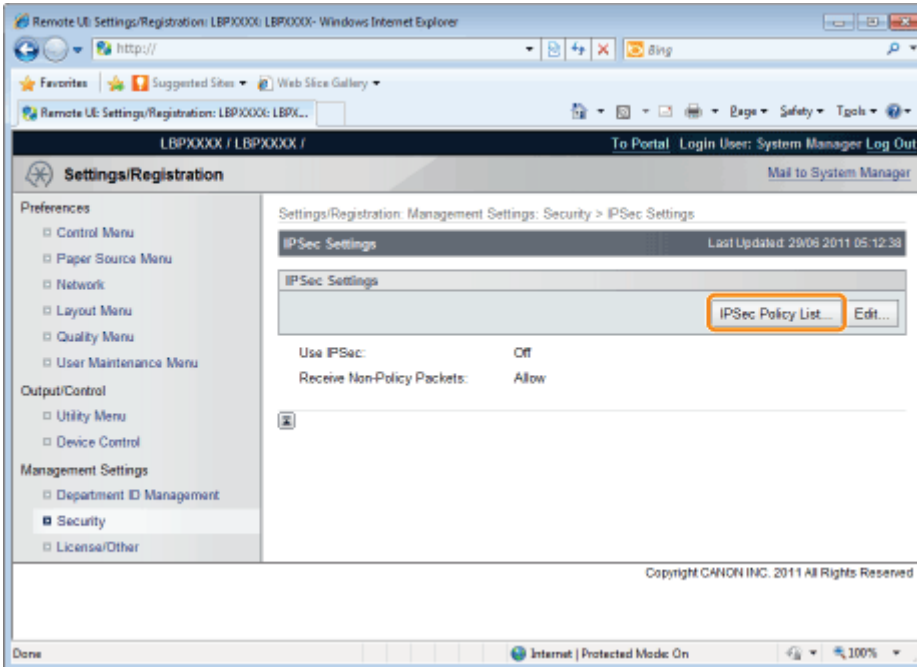

2

Perform the necessary operations on the [IPSec Policy List] page.

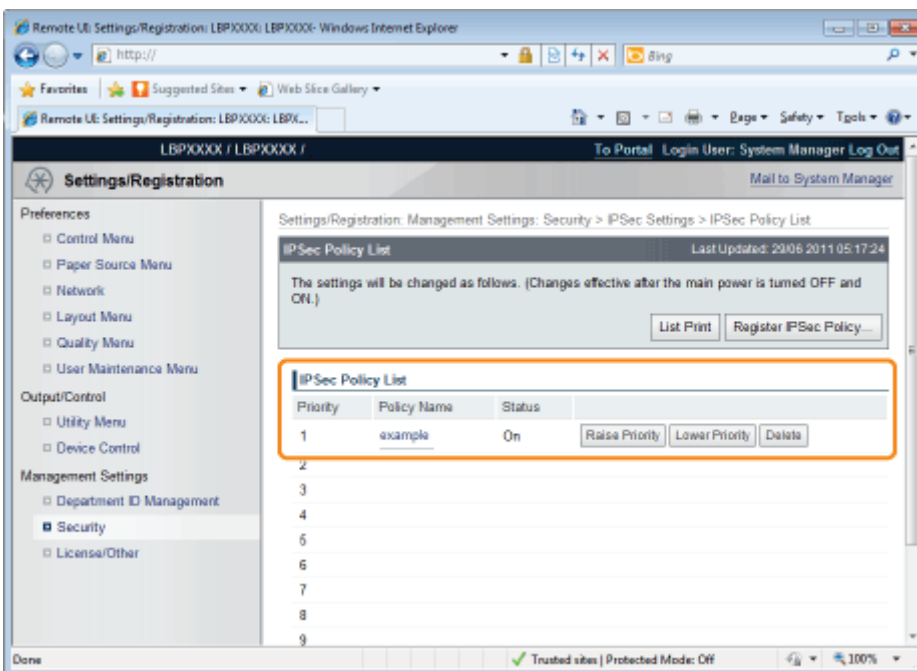

When editing security policies

- (1) Click the policy name displayed in the [Policy Name] field.
- (2) See "Adding a New Security Policy", and edit the content.

When deleting security policies

- (1) Click [Delete] on the security policy you wish to delete.
- (2) Click [OK].

When changing the priority of security policies

The higher up the list the security policy is, the higher its priority.

Click [Raise Priority] or [Lower Priority] for the security policy whose priority you wish to change, and change the priority.

3

Perform a hard reset or restart the printer.

→ After performing a hard reset or restarting the printer, the settings are effective.

NOTE

To perform a hard reset

You can perform a hard reset using the following procedure.

1. Click [Settings/Registration].
2. Select [Device Control] from the [Output/Control] menu.
3. Select [Hard Reset], and then click [Execute].

Enabling IPsec Encryption Communication

04L9-0FO

1

Click [Edit...] on the [IPsec Settings] page.

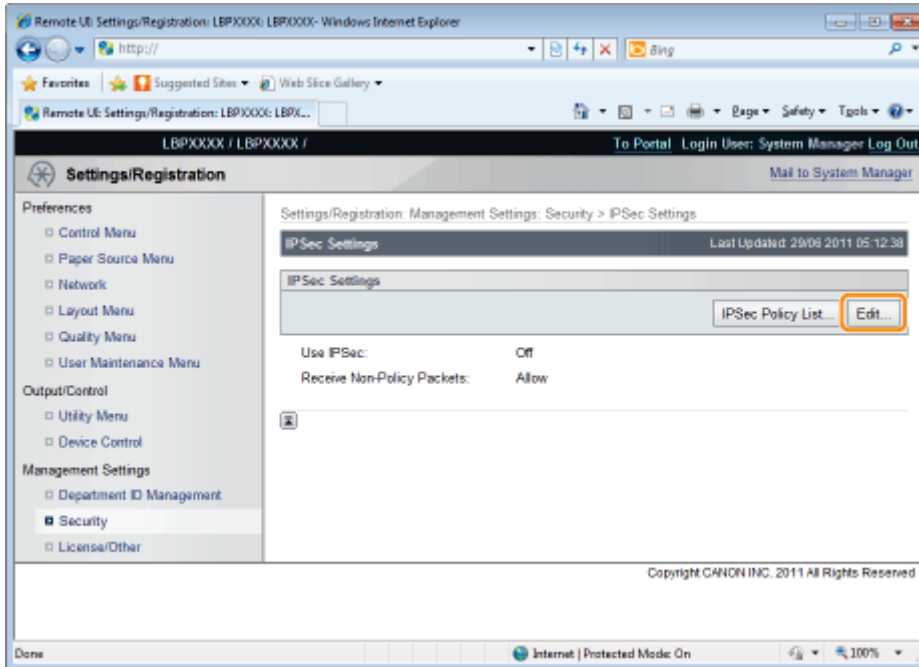

2

Select the [Use IPsec] check box.

† In order to allow receipt of non-policy packets, select the [Allow Receive Non-Policy Packets] check box.

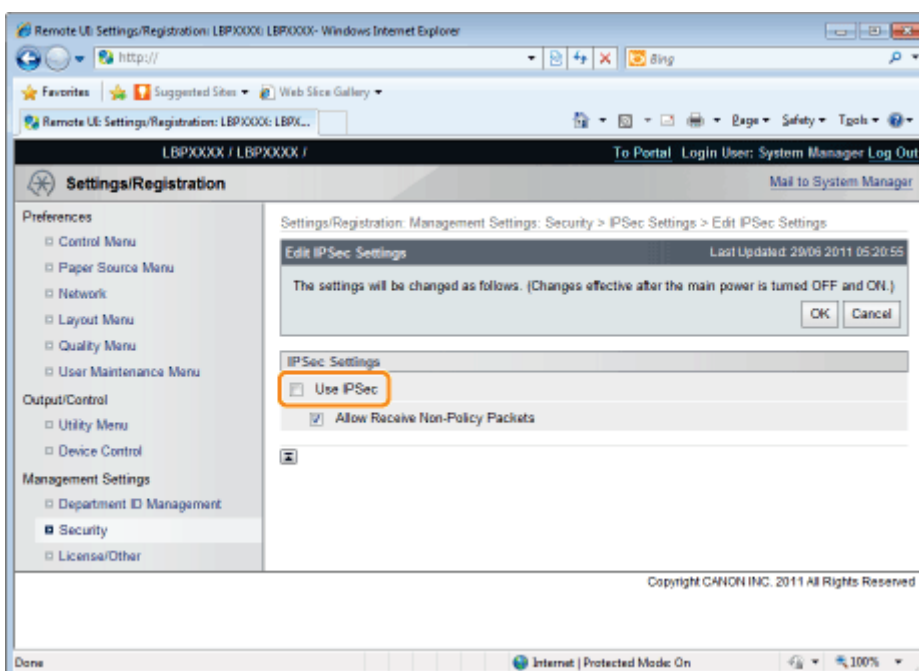

3

Perform a hard reset or restart the printer.

→ After performing a hard reset or restarting the printer, the settings are effective.

NOTE

To perform a hard reset

You can perform a hard reset using the following procedure.

1. Click [Settings/Registration].
2. Select [Device Control] from the [Output/Control] menu.
3. Select [Hard Reset], and then click [Execute].

Specifying the Setting for Job Log Display

04L9-0F1

You can specify the setting for Job Log Display using a Web browser (Remote UI).

1

Start the Remote UI, and then log in as Administrator.

❖ "Starting the Remote UI"

2

Click [Settings/Registration].

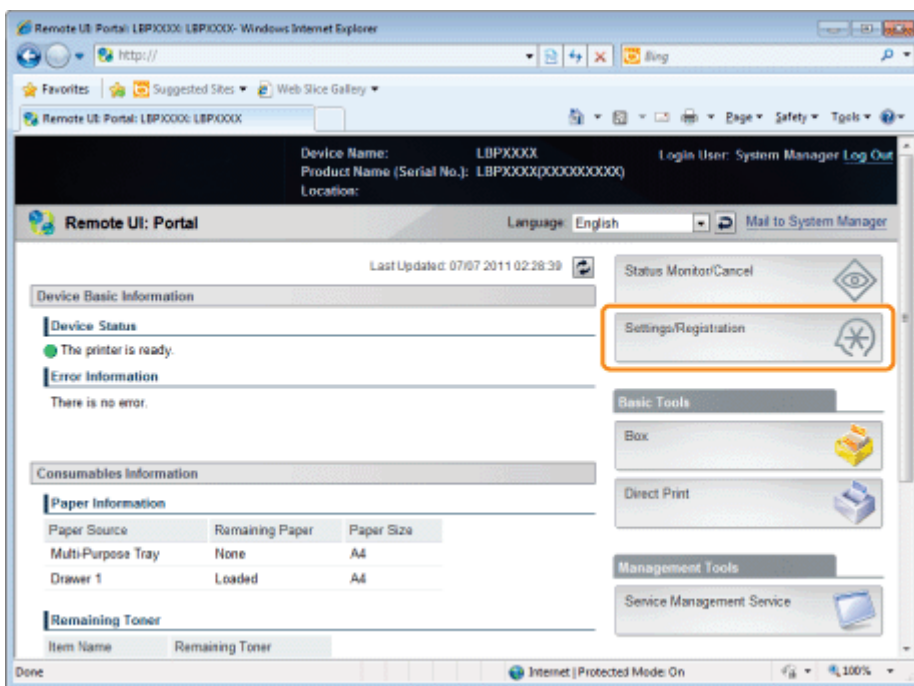

3

Select [Security] from the [Management Settings] menu.

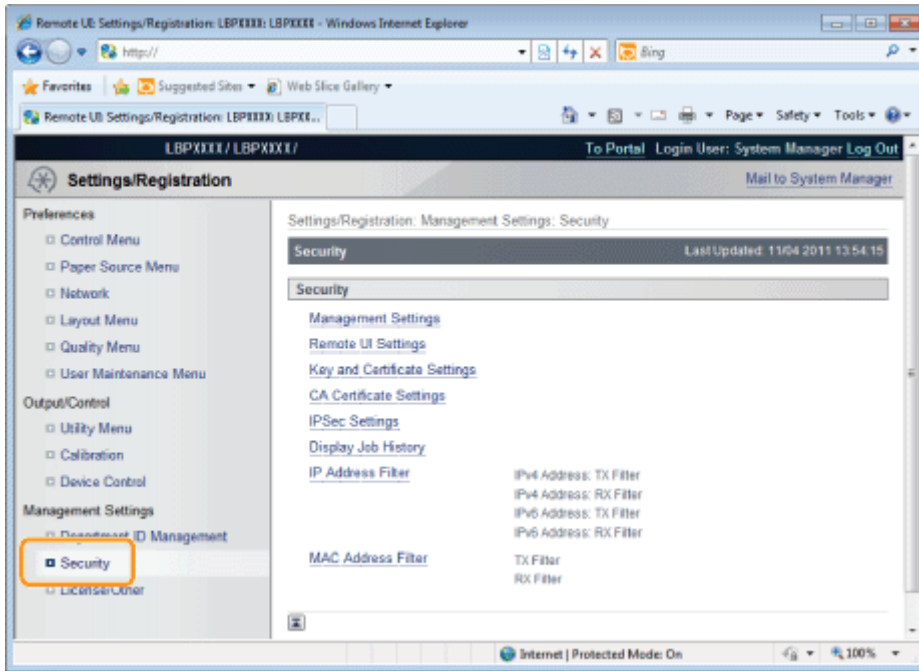

4

Click [Display Job History].

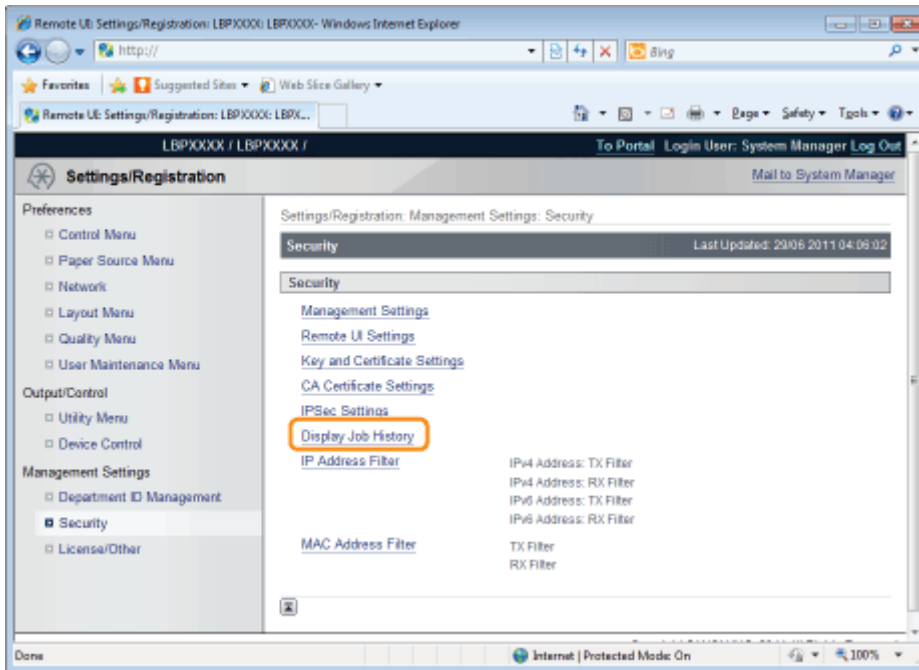

5

Click [Edit...].

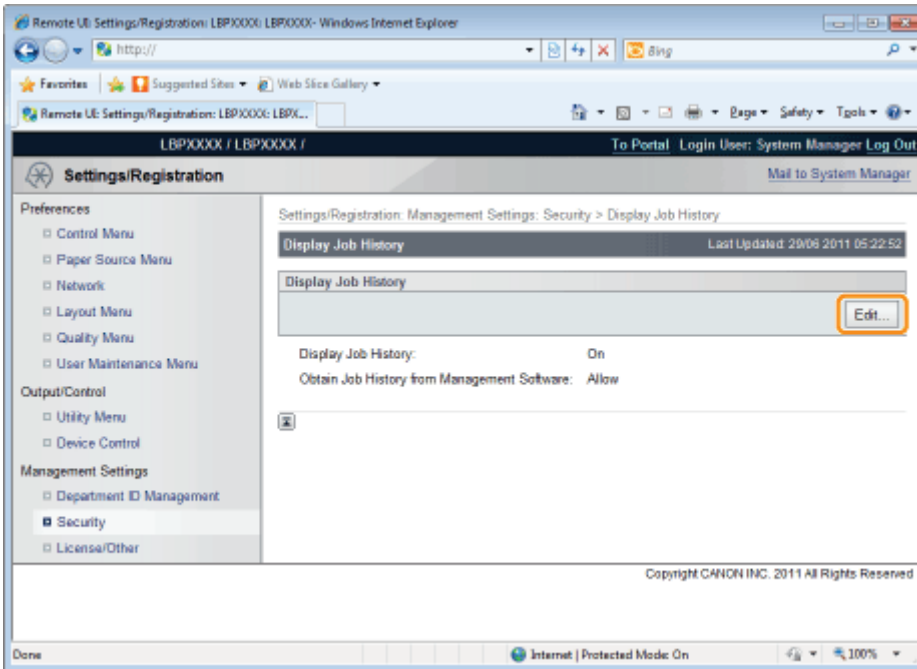

6

Specify whether the printer should display the job logs.

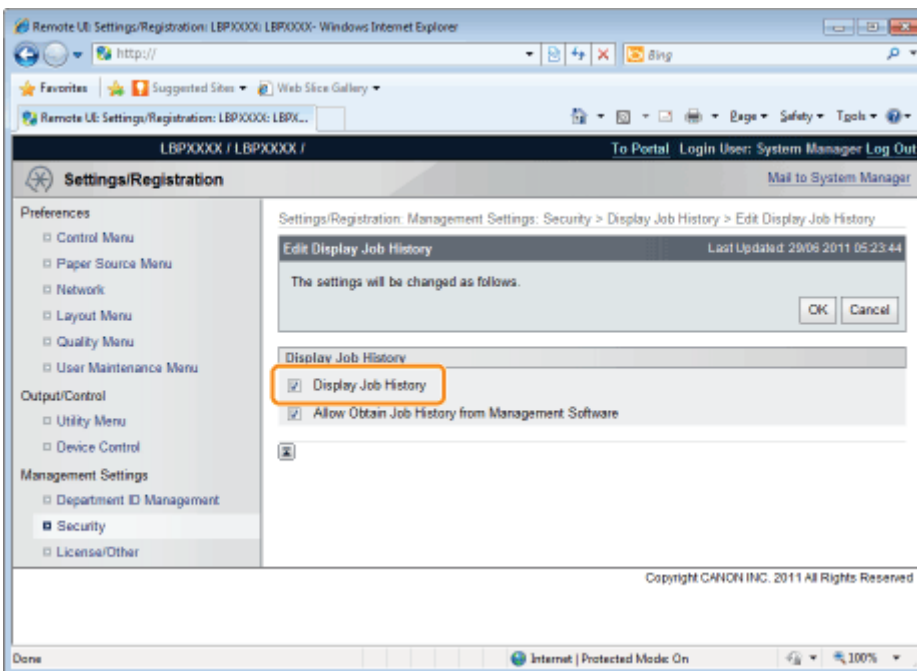

If the [Display Job History] check box is selected, you can display the job logs*.
If the [Display Job History] check box is cleared, the job logs* are not displayed.

* The [Job History] page in the [Status Monitor/Cancel] menu

7

Select whether to permit management software to obtain job logs.

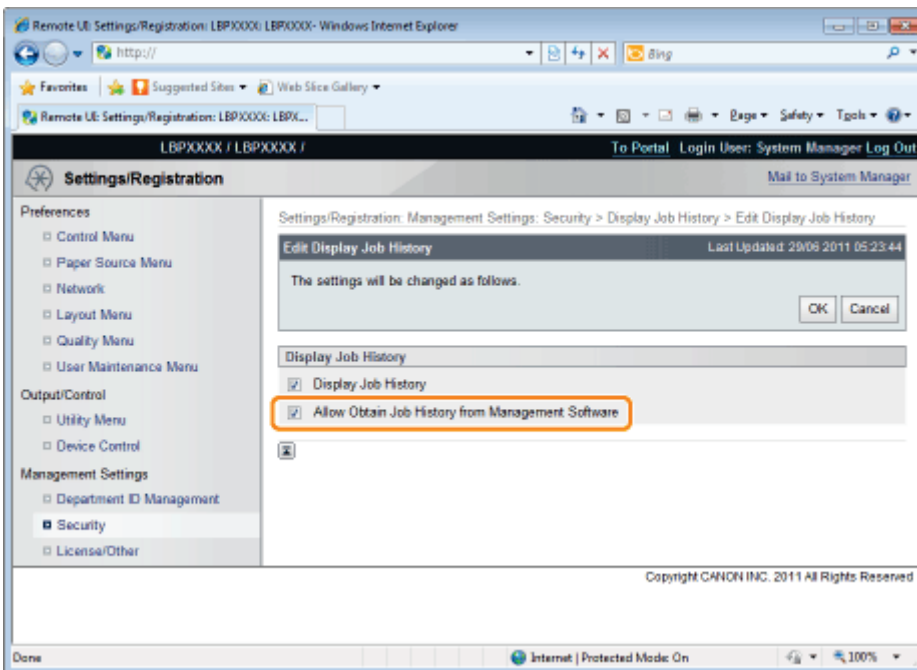

If the [Allow Obtain Job History from Management Software] check box is selected, you can obtain the job logs from management software.

If the [Allow Obtain Job History from Management Software] check box is cleared, job logs cannot be obtained from management software.

NOTE

If the [Display Job History] check box is selected

The [Allow Obtain Job History from Management Software] check box is selected automatically.

8

Click [OK].

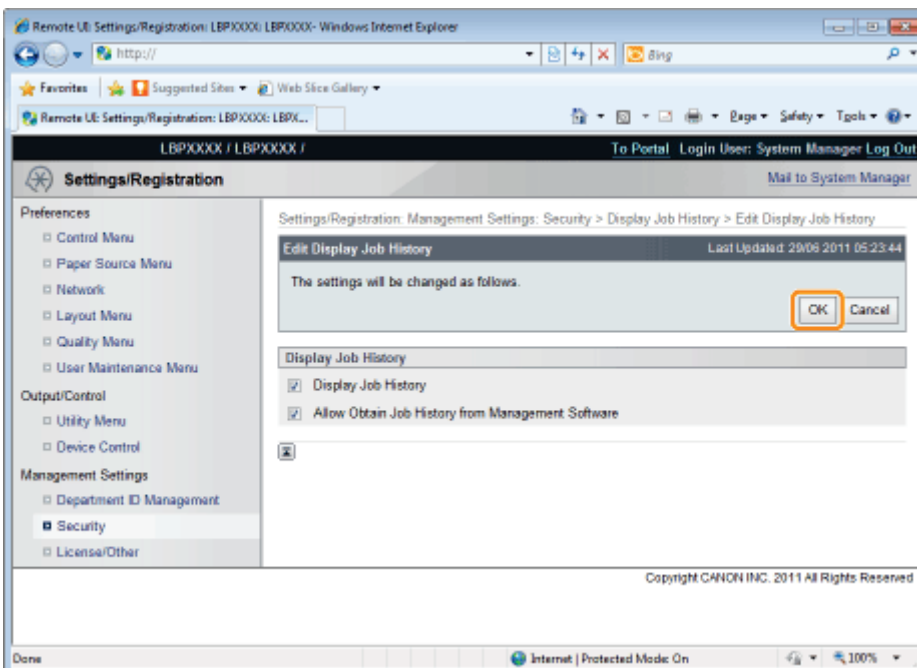

MEAP (LBP6680x Only)

04L9-0F2

[➤ Available Functions](#)

[➤ Launching and Closing SMS](#)

[➤ MEAP Application Settings](#)

[➤ System Settings](#)

[➤ List of Error Messages \(MEAP\)](#)

Available Functions

04L9-0F3

SMS (Service Management Service) is software that accesses the printer over the network from an existing Web browser, and can install and manage MEAP applications (called "applications" in this document). Since the software (Web server) for using SMS is embedded in the printer, there is no need for any software other than a Web browser.

If a printer on the network is connected to a computer, it can use SMS. You can perform the following operations using SMS.

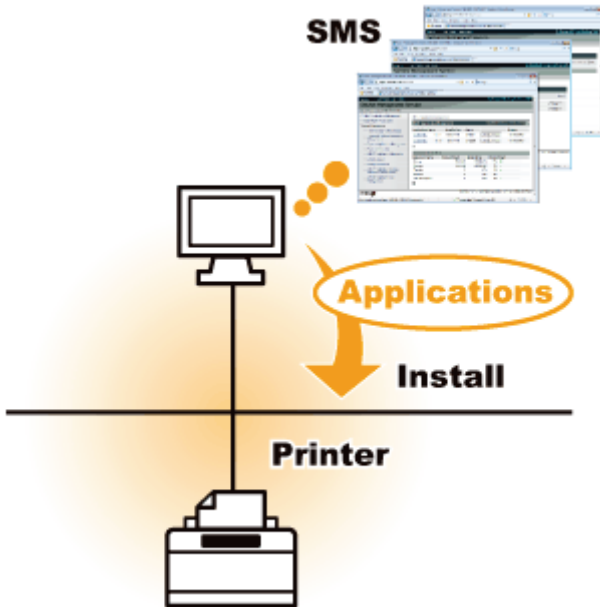

You can check application information from computers on the network

You can access the printer via the network and display the status and information of installed applications.

After SMS launches and you log in by entering your password in the [Log In] page, the following top page is displayed.

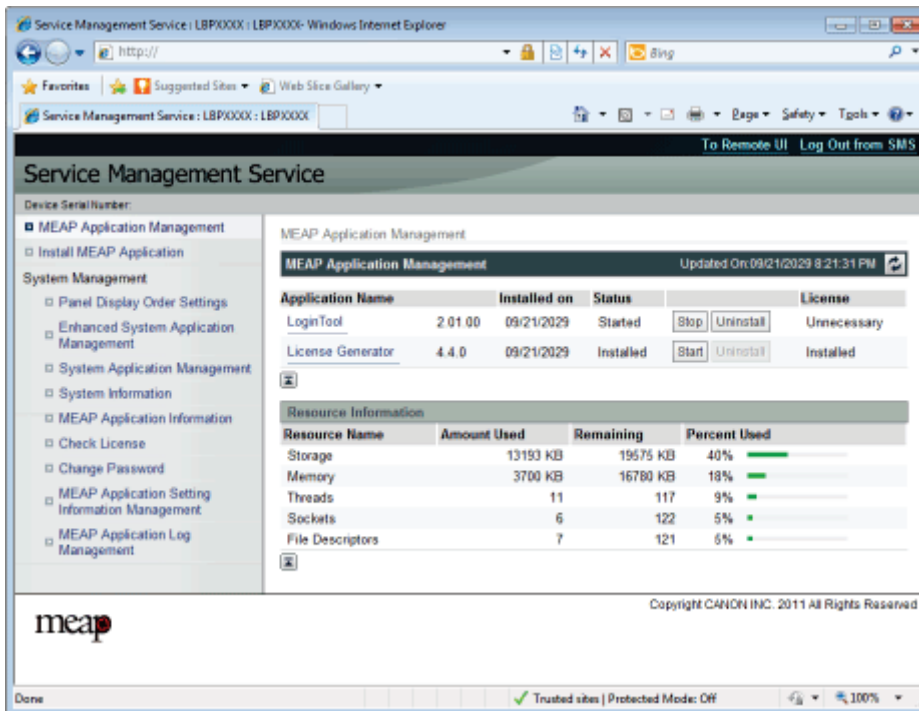

(1) [MEAP Application Management]

It can display the status of applications that are installed in the printer.

- "MEAP Application Settings"

(2) [Install MEAP Application]

Install the MEAP application.

- ["Installing MEAP Applications"](#)

(3) [System Management]

MEAP system administrator settings are used for setting system application settings, displaying information and changing passwords, etc.

- ["System Settings"](#)

You can install and uninstall applications

You can install and uninstall applications that support this printer from the computer.

- ["Installing MEAP Applications"](#)
- ["Uninstalling MEAP Applications"](#)

You can update installed applications and license files

If the license for the installed applications has expired, you can reinstall and update it.

- ["Adding License Files"](#)
-

Launching and Closing SMS

04L9-0F4

Log in is required to use SMS.

[Before Launching SMS \(Preparation\)](#)

[Launching SMS \(Log in\)](#)

[Closing SMS \(Logging Out\)](#)

NOTE

Web Browser Settings

The following settings are required.

- JavaScript must be enabled
- The use of session cookies must be enabled
- When a proxy server is used, using the proxy server settings of your Web browser, add the IP address of the printer to the [Exceptions] (addresses that do not use a proxy) list.
Since settings differ depending on the network environment, consult with your network administrator.

Launching SMS

Multiple users cannot log in to SMS at the same time.

Automatic SMS Logout

While SMS is in use, if it is not accessed for approximately five minutes or more it times out and the user is automatically logged out. If that happens, log in again from the [Login] page.

Do not use the Web browser's [Back] navigation button

If you use the Web browser's [Back] navigation button, SMS may not operate properly.

SMS System Environment

SMS operation is guaranteed in the following system environments.

Web Browsers	<ul style="list-style-type: none">• Internet Explorer 6 Service Pack 1, or later• Safari 1.3.2 or later
Operating system	<ul style="list-style-type: none">• Windows XP Professional SP3• Windows Vista SP2• Windows 7• Mac OS X 10.4.9 or later

Before Launching SMS (Preparation)

04L9-0F5

Set the following before launching SMS.

Step 1	Set [Network].	➤ "Configuring the Network Settings (Sharing the Printer)"
Step 2	Check the printer's IP address.	➤ "Checking the Printer Settings"
Step 3	Set it so that the printer can be accessed from the Web browser.	➤ "Setting Up HTTP Communication"

Setting Up HTTP Communication

04L9-0F7

In order to use MEAP functions from the Web browser, HTTP communication must be enabled.
Follow the steps in the procedure below to configure the settings. (The default settings are [On].)

1

Press [] (: Settings), select [Network] with [▲] and [▼], and then press [OK].

After the message is displayed, press [OK].

2

Select [TCP/IP Settings] with [▲] and [▼], and then press [OK].

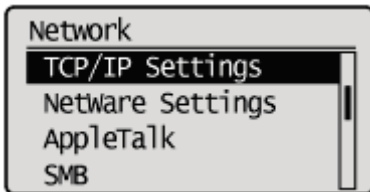

3

Select [HTTP] with [▲] and [▼], and then press [OK].

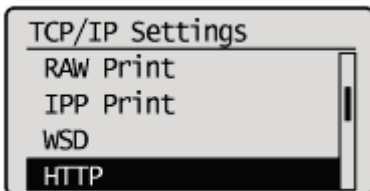

4

Select [On] with [▲] and [▼], and then press [OK].

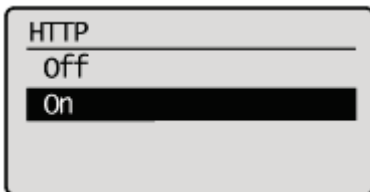

[On]	It uses HTTP.
[Off]	It does not use HTTP.

5

Hard reset or restart the printer.

The settings are enabled after a hard reset or after the printer is restarted.

 **NOTE**

Details about Hard Resets

See "[Canceling All the Jobs \(Hard Reset\)](#)."

Launching SMS (Log in)

04L9-0F8

The following two methods are used for launching SMS.

- ❖ Launching SMS directly from the Web browser
- ❖ Launching SMS from a Remote UI

Before launching SMS, see "Attention (Launching SMS (Log in))."

Launching SMS directly from the Web browser

1

Start the Web browser.

2

Enter "**https://<Printer's IP address>:8443/sms/**" in the address bar, and then press [ENTER] from the Enter key on the keyboard.

- Entry Example: `https://192.168.0.215:8443/sms/`
- † If the printer's host name is registered in the DNS server, you can enter [host name.domain name] instead of the IP address.
 - Input Example: `http://my_printer.xy_dept.company.com:8443/sms/`

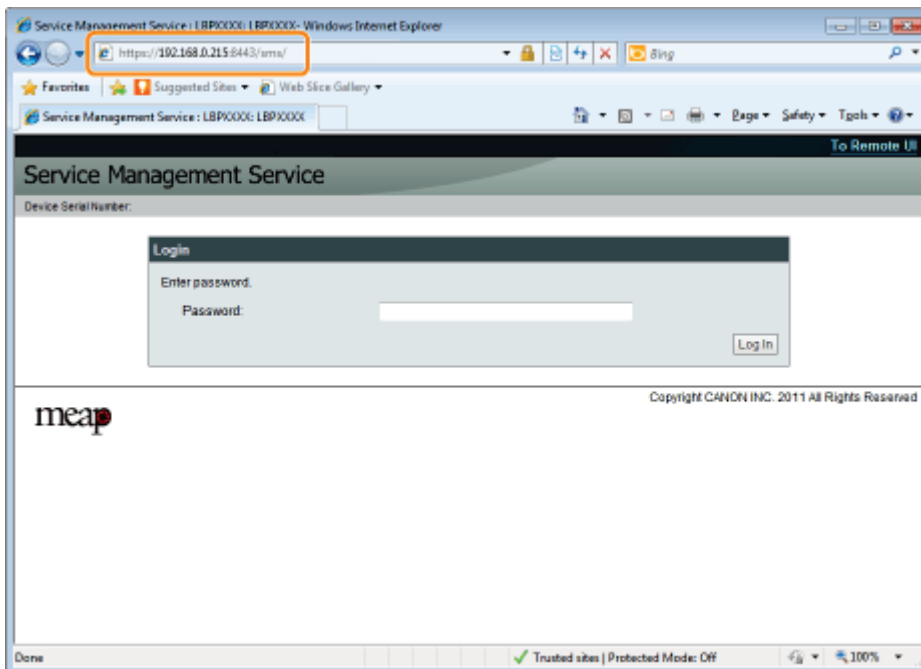

❓ If SMS does not launch

Check the following.

- HTTP communication is enabled.
 - ❖ "Setting Up HTTP Communication"
- The computer and printer are connected properly over the network.
- The printer is turned ON.
- The IP address or [host name.domain name] are entered correctly.

NOTE

Device Serial Number

The printer's device serial number is displayed on the upper left of the screen. (The device serial number is required to obtain the license file from the license management system.)

3

Enter the password, and then click [Login].

† The default password is "MeapSmsLogin" (case sensitive).

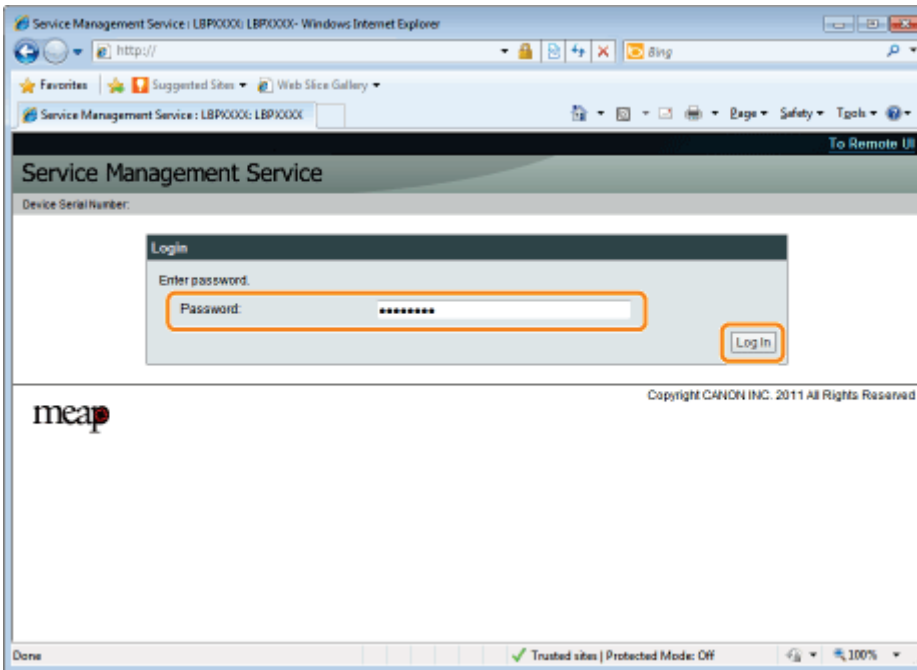

If you cannot log in

If you cannot log in because the password is not correct, a message is displayed prompting you to re-enter your password.

Enter the correct password, and then click [Login].

- † If you do not log in within approximately 5 minutes after the login page is displayed, you will not be able to log in even if you enter the correct password.
- † A switch license file is required to initialize passwords. After clicking on [Browse] in [Initialize Password] in the screen that displays the message prompting password re-entry, select Switch License File, and then click [Initialize]. Contact your local authorized Canon dealer or sales representatives.

Launching SMS from a Remote UI

1

Start the Remote UI and log on in system manager mode.

 "Starting the Remote UI"

2

Click [Service Management Service] on the portal page.

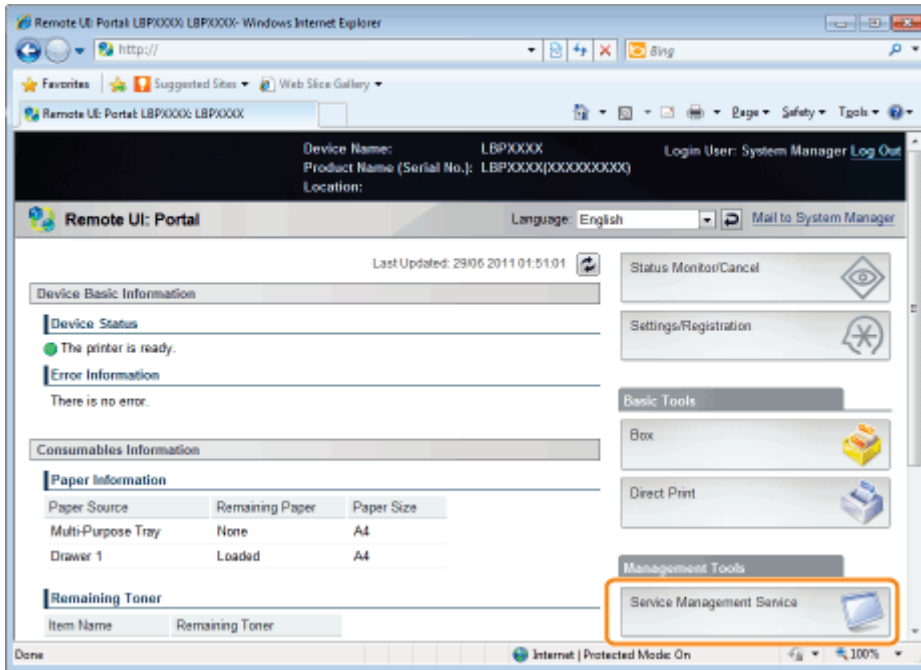

3

Enter the password, and then click [Login].

† The default password is "MeapSmsLogin" (case sensitive).

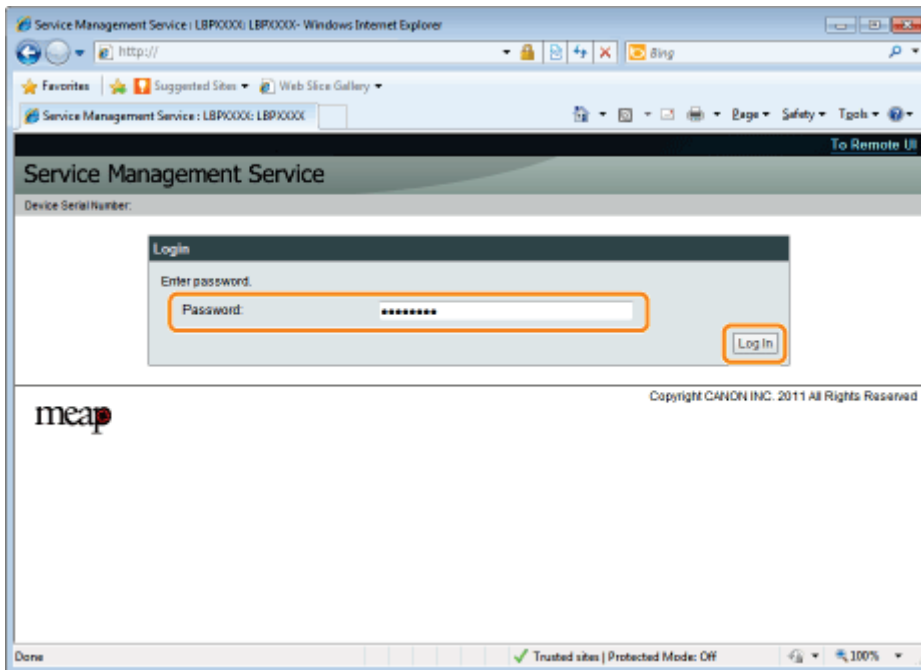

? If you cannot log in

If you cannot log in because the password is not correct, a message is displayed prompting you to re-enter your password.

Enter the correct password, and then click [Login].

- † If you do not log in within approximately 5 minutes after the login page is displayed, you will not be able to log in even if you enter the correct password.
- † A switch license file is required to initialize passwords. After clicking on [Browse] in [Initialize Password] in the screen that displays the message prompting password re-entry, select Switch License File, and then click [Initialize]. Contact your local authorized Canon dealer or sales representatives.

Attention (Launching SMS (Log in))

04L9-0F9

IMPORTANT

SMS Password

- To prevent unauthorized access, We recommend that the administrator change the password before SMS use is begun. See "[Changing the SMS Password](#)" when changing passwords.
- This password is to prevent unauthorized operation of the printer. Do not let anyone know except the administrator.
- Make sure that you do not forget your password. If you forget your password, you will not be able to use SMS. If this happens, contact your local dealer.

Closing SMS (Logging Out)

04L9-0FA

Click [Log Out from SMS] to close SMS.

† If you close the Web browser without clicking [Log Out from SMS], SMS becomes temporarily unusable.

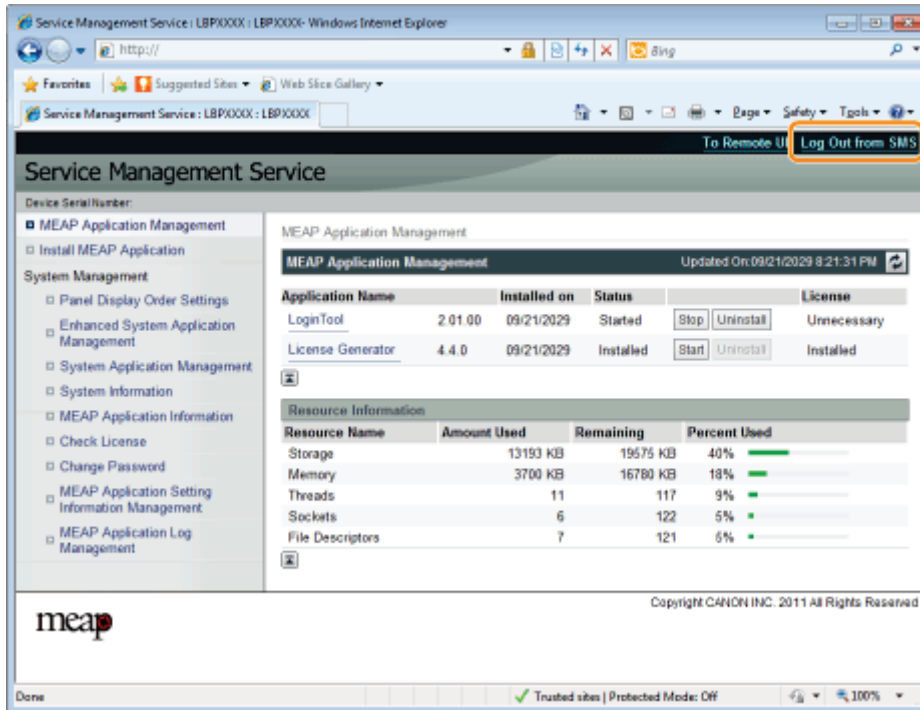

MEAP Application Settings

04L9-0FC

MEAP applications are set from the [MEAP Application Management] and the [Install MEAP Application] menus.

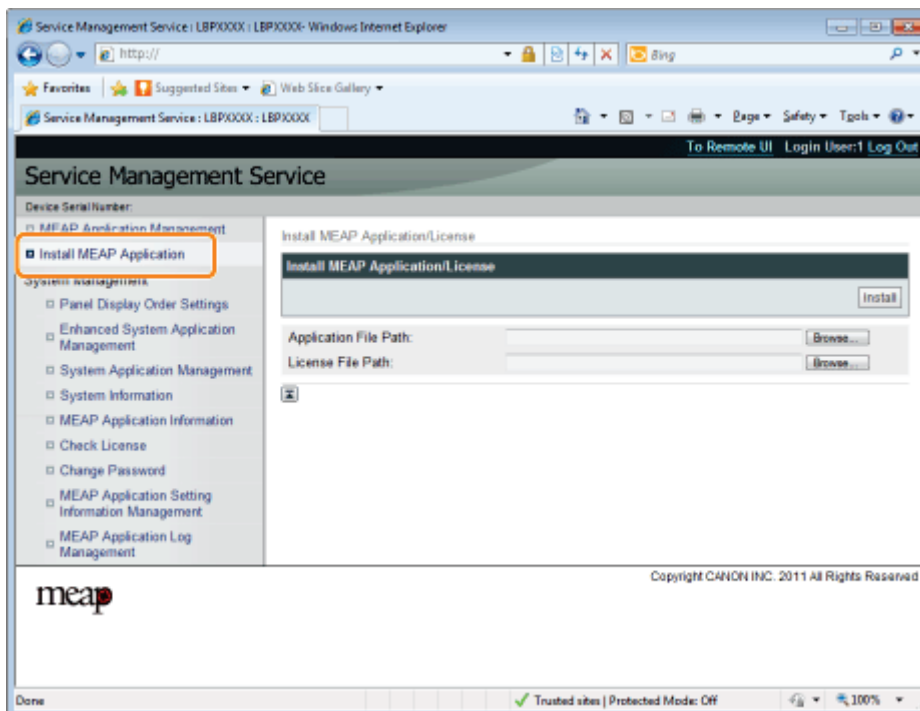
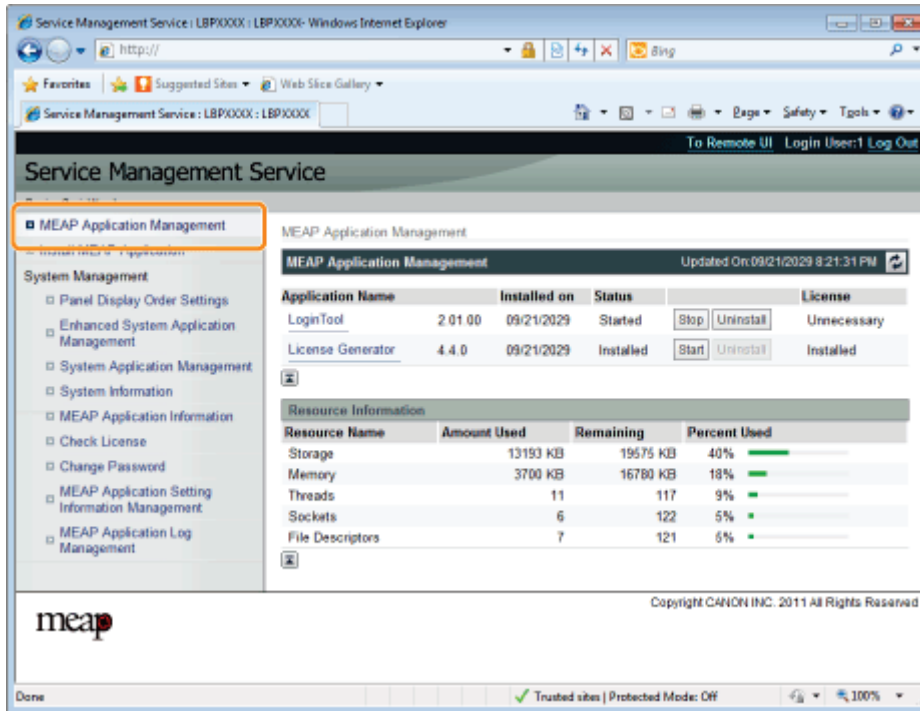

Items shown in the [MEAP Application Management] menu

[Application Name]	The name of the application is displayed.
[Installed on]	The date on which the application was installed is displayed.
	<p>The status of the application is displayed.</p> <ul style="list-style-type: none"> [Installed]: The application has been installed, but not started. Or, the printer was turned OFF after the application stopped, and after the printer was

[Status]	<p>restarted the application was not yet started.</p> <ul style="list-style-type: none"> • [Started]: The application is running. • [Stopped]: The application is stopped. • [Starting]: The application is starting up. • [Stopping]: The application is closing down. 						
[License]	<p>The license status of the application is displayed.</p> <ul style="list-style-type: none"> • [Installed]: A valid license file has been installed. • [Not Installed]: The license file has been disabled. • [Over Limit]: The license file that is installed has an expiration date, and multiple types of counters have been set. One or more of the counter values has exceeded the upper limits of the counter. • [Invalid]: The installed license file has passed its expiration date. Or, the current counter value has exceeded the upper limit of the license file. <p>* When upper limits have been set for multiple types of counters, the license will become invalid at the point in time when any counter exceeds its upper limit.</p> <ul style="list-style-type: none"> • [Unnecessary]: The application does not require a license file for startup. 						
[Resource Information]	<p>The resources being used by the applications are displayed.</p> <ul style="list-style-type: none"> • [Storage]: The amount of storage being used. It is shown in kilobyte units (KB). • [Memory]: The amount of memory being used. It is shown in kilobyte units (KB). • [Threads]: The number of threads. • [Sockets]: The number of sockets. • [File Descriptors]: The number of file descriptors. <div style="border: 1px solid black; padding: 10px; margin-top: 10px;"> <p> NOTE</p> <p>Timing of [Resource Information] Updates</p> <p>[Resource Information] is updated at the following times.</p> <table border="1" data-bbox="493 1603 1370 1883"> <thead> <tr> <th data-bbox="493 1603 778 1666">Item</th> <th data-bbox="778 1603 1370 1666">Timing of Updates</th> </tr> </thead> <tbody> <tr> <td data-bbox="493 1666 778 1718">[Storage]</td> <td data-bbox="778 1666 1370 1718">When the application is installed or uninstalled</td> </tr> <tr> <td data-bbox="493 1718 778 1883">[Memory] [Threads] [Sockets] [File Descriptors]</td> <td data-bbox="778 1718 1370 1883">When the application starts or stops</td> </tr> </tbody> </table> </div>	Item	Timing of Updates	[Storage]	When the application is installed or uninstalled	[Memory] [Threads] [Sockets] [File Descriptors]	When the application starts or stops
Item	Timing of Updates						
[Storage]	When the application is installed or uninstalled						
[Memory] [Threads] [Sockets] [File Descriptors]	When the application starts or stops						

[Install MEAP Application] Menu Settings

	<p>Install the MEAP application.</p> <ul style="list-style-type: none"> • [Install]:
--	--

[Install MEAP Application/License]

Specify the application file and license file to be installed, and then click [Install] to start the installation.

- **[Application File]:**
Specify the application file to be installed.
- **[License File]:**
Specify the license file.

See the following section for settings that use the [MEAP Application Management] and [Install MEAP Application] menus.

[Installing MEAP Applications](#)

[Uninstalling MEAP Applications](#)

[Starting/Stopping MEAP Applications](#)

[Checking the Details of MEAP Applications](#)

[MEAP Application License Settings](#)

[Setting Authentication Information for MEAP Applications](#)

Installing MEAP Applications

04L9-0FE

Before starting the following operation, see "Attention (Installing MEAP Applications)."

1

Start SMS (Service Management Service).

❖ "Launching SMS (Log in)"

2

Click [Install MEAP Application].

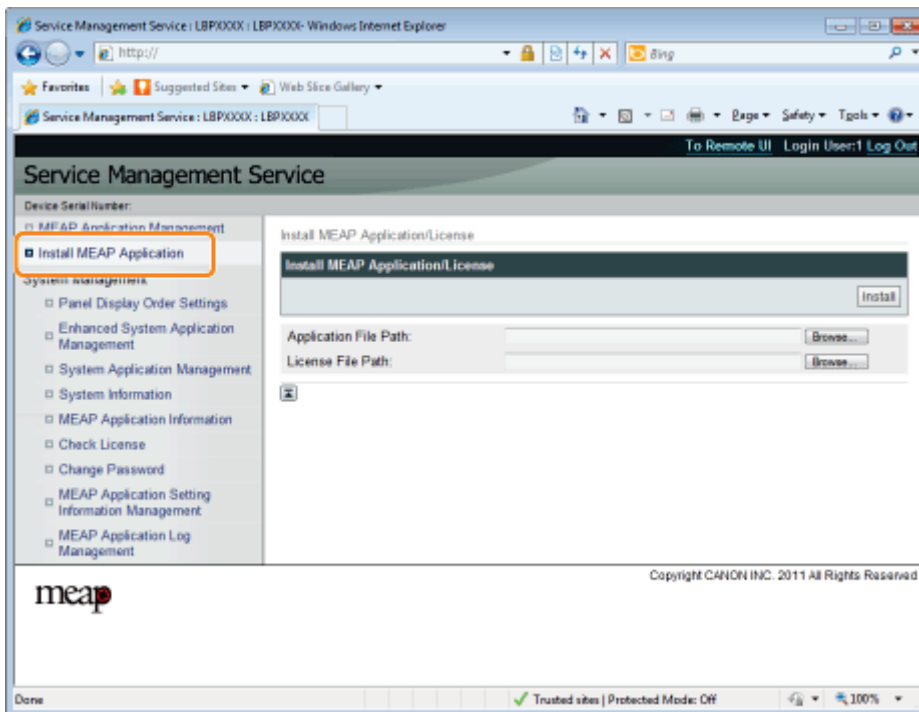

3

Set [Application File Path] and [License File Path].

Either select the file by clicking [Browse...], or enter the location where the file is stored.

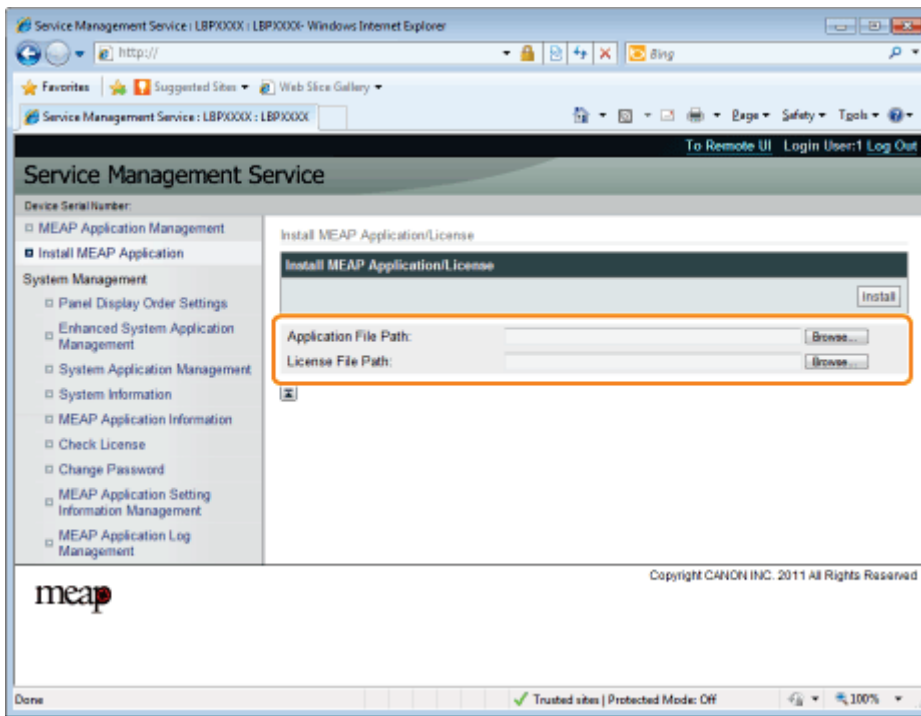

[Application File Path]	Specify a file with a "jar" extension.
[License File Path]	Specify a file with a "lic" extension.

4

Click **[Install]**.

5

Confirm the information on the install confirmation page, and then click **[Yes]**.

When the [License Agreement] appears, confirm the information, and then click [I Accept].

→ The installation begins.

<Information Displayed on the Install Confirmation Page>

If you are installing a new application

[Application Information]	Information about the application
[License Information]	The expiration date of the application

If you are updating an application

[Application Information]	[Current Application Information]	Information about the current application
	[Application Information after Overwrite]	Application information after overwrite
[License Information]	[Expires after]	The expiration date of the targeted application
	[Current Counter Usage Limit]	Current counter information
	[Counter Usage Limit after Overwrite]	Counter information after overwrite

? If the install is cancelled

If the shutdown process for the printer starts while an application is being installed, an error message may be displayed on the [Install] page for SMS, and the installation cancelled. If this happens, install the application again after restarting the printer by turning the main power switch OFF and then back ON again.

6

After the install is completed, click [To MEAP Application Management].

NOTE

When using the installed application

Start the application.

-  ["Starting MEAP Applications"](#)

Attention (Installing MEAP Applications)

04L9-OFF

IMPORTANT

Installing Applications

- There may be other specific requirements for installation, depending on the application. For more information, see the instruction manual provided with the application.
- You can install up to eight applications.
- You cannot install license files only. Specify both the application file and the license file.
To only add a license file for an application that is already installed, see "[Adding License Files](#)."

Obtaining License Files

- In order to install an application, a valid license file is required.
If you have a license access number in your application package, obtain a valid license file from License Management System (<http://www.canon.com/lms/license/>).
 - † In order to obtain a license file, a license access number and a device serial number (the number displayed on the upper left of the SMS screen) are required.
- If you do not have a license access number in your application package, it will be provided by the dealer where you purchased the application. For more information, see the instruction manual provided with the application.

Storage Area

The application can use a maximum storage area of 32MB. You can confirm the storage space used by the application "Storage", under resource information displayed on the [MEAP Application Management] page.

When you are updating an application

Stop the application before installing the new version.

- ["Stopping MEAP Applications"](#)

Uninstalling MEAP Applications

04L9-0FH

IMPORTANT

If the license status is not "Not Installed"

Uninstall the application after disabling and deleting the license files.

- "Disabling License Files"
- "Deleting Disabled License Files"

1

Start SMS (Service Management Service).

- "Launching SMS (Log in)"

2

Click [MEAP Application Management].

The screenshot shows a web browser window displaying the Service Management Service interface. The left sidebar contains a navigation menu with 'MEAP Application Management' highlighted. The main content area shows the 'MEAP Application Management' page, which includes a table of installed applications and a resource information section.

Application Name	Installed on	Status	License
LoginTool	2 01 00 09/21/2029	Started	Unnecessary
License Generator	4 4 0 09/21/2029	Installed	Installed

Resource Name	Amount Used	Remaining	Percent Used
Storage	13193 KB	19575 KB	40%
Memory	3700 KB	16780 KB	18%
Threads	11	117	9%
Sockets	6	122	5%
File Descriptors	7	121	6%

3

Click [Uninstall] for the application to uninstall.

- † Applications with [Uninstall] grayed out cannot be deleted.

4

Click [Yes].

- The uninstall begins.

? When the restart prompt message is displayed

Follow the onscreen instructions to restart the printer.

👤 IMPORTANT

If <A package exported from this application cannot be used.> is displayed

and you uninstall the application that displayed this message, you may not be able to use other applications.

Starting/Stopping MEAP Applications

04L9-0FJ

↳ Starting MEAP Applications

↳ Stopping MEAP Applications

Starting MEAP Applications

04L9-0FK

1

Start SMS (Service Management Service).

➤ "Launching SMS (Log in)"

2

Click [MEAP Application Management].

The screenshot shows the Service Management Service web interface in Internet Explorer. The browser address bar shows 'http://'. The page title is 'Service Management Service'. The main content area is titled 'MEAP Application Management' and includes a table of installed applications and a 'Resource Information' section.

Application Name	Installed on	Status	License
LoginTool	2.01.00 09/21/2029	Started	Unnecessary
License Generator	4.4.0 09/21/2029	Installed	Installed

Resource Name	Amount Used	Remaining	Percent Used
Storage	13193 KB	19575 KB	40%
Memory	3700 KB	16780 KB	18%
Threads	11	117	9%
Sockets	6	122	5%
File Descriptors	7	121	5%

3

Click [Start] for the application to start.

? If the application does not start

Check the following.

- The required license file has been installed
- There is sufficient [Memory], [Threads], [Sockets] and [File Descriptors] under [Resource Information]

? When the restart prompt message is displayed

Follow the onscreen instructions to restart the printer.

Stopping MEAP Applications

04L9-0FL

1

Start SMS (Service Management Service).

➤ "Launching SMS (Log in)"

2

Click [MEAP Application Management].

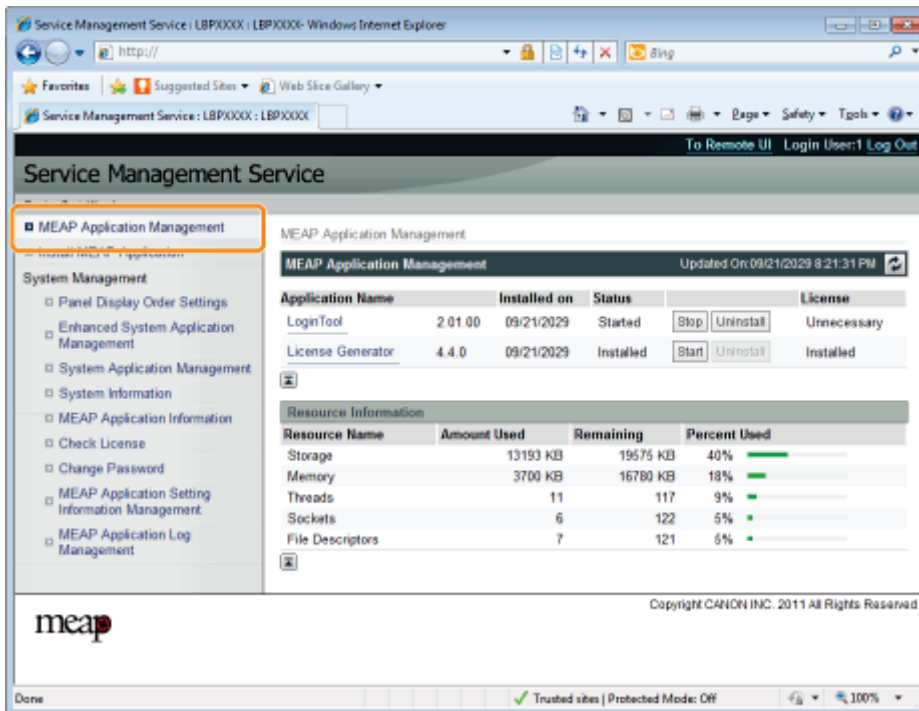

The screenshot shows the Service Management Service (SMS) web interface in Internet Explorer. The browser address bar shows "http://". The page title is "Service Management Service". The main content area is titled "MEAP Application Management" and includes a table of installed applications and a "Resource Information" section.

Application Name	Installed on	Status	License
LoginTool	2.01.00 09/21/2029	Started	Unnecessary
License Generator	4.4.0 09/21/2029	Installed	Installed

Resource Name	Amount Used	Remaining	Percent Used
Storage	13193 KB	19575 KB	40%
Memory	3700 KB	16780 KB	18%
Threads	11	117	9%
Sockets	6	122	5%
File Descriptors	7	121	5%

3

Click [Stop] for the application to stop.

Service Management Service | LBPXXXX | LBPXXXX - Windows Internet Explorer

http://

Service Management Service : LBPXXXX : LBPXXXX

To Remote UI | Login User:1 | Log Out

Service Management Service

Device Serial Number:

- MEAP Application Management
 - Install MEAP Application
- System Management
 - Panel Display Order Settings
 - Enhanced System Application Management
 - System Application Management
 - System Information
 - MEAP Application Information
 - Check License
 - Change Password
 - MEAP Application Setting Information Management
 - MEAP Application Log Management

MEAP Application Management

Updated On: 09/21/2029 4:21:31 PM

Application Name	Installed on	Status	Stop	Uninstall	License
LoginTool	2.01.00 09/21/2029	Started	Stop	Uninstall	Unnecessary
License Generator	4.4.0 09/21/2029	Installed	Start	Uninstall	Installed

Resource Information

Resource Name	Amount Used	Remaining	Percent Used
Storage	13193 KB	19575 KB	40%
Memory	3700 KB	16700 KB	18%
Threads	11	117	9%
Sockets	6	122	5%
File Descriptors	7	121	5%

Copyright CANON INC. 2011 All Rights Reserved

meap

Done Trusted sites | Protected Mode: Off 100%

? When the restart prompt message is displayed

Follow the onscreen instructions to restart the printer.

Checking the Details of MEAP Applications

04L9-0FR

Check the details of installed applications.

1

Start SMS (Service Management Service).

➤ "Launching SMS (Log in)"

2

Click [MEAP Application Management].

The screenshot shows the Service Management Service web interface in a Windows Internet Explorer browser. The page title is "Service Management Service" and the URL is "http://". The interface includes a navigation menu on the left with "MEAP Application Management" highlighted. The main content area displays "MEAP Application Management" with a table of installed applications and a "Resource Information" section.

Application Name	Installed on	Status	License
LoginTool	2 01 00 09/21/2029	Started	Unnecessary
License Generator	4.4.0 09/21/2029	Installed	Installed

Resource Name	Amount Used	Remaining	Percent Used
Storage	13193 KB	19575 KB	40%
Memory	3700 KB	16780 KB	18%
Threads	11	117	9%
Sockets	6	122	5%
File Descriptors	7	121	6%

3

Click the application to check the details.

→ [Application/License Information] is displayed on the screen.

Service Management Service | LBPXXXX | LBPXXXX - Windows Internet Explorer

http://

Service Management Service : LBPXXXX : LBPXXXX

To Remote UI | Login User:1 | Log Out

Service Management Service

Device Serial Number:

- MEAP Application Management
 - Install MEAP Application
- System Management
 - Panel Display Order Settings
 - Enhanced System Application Management
 - System Application Management
 - System Information
 - MEAP Application Information
 - Check License
 - Change Password
 - MEAP Application Setting Information Management
 - MEAP Application Log Management

MEAP Application Management > Application/License Information

Application/License Information

Authentication Information Settings | Back

Application Information

Application Name:	License Generator
Version:	4.4.0
Application ID:	c7cfe565-0319-4f24-b511-bbd9c08690cc
Installed on:	09/20/2029
Description:	genlic
Manufacturer:	Canon Inc.
Import Package:	javax.servlet http javax.servlet.http org.osgi.service.http com.canon.meap.service.http
Import Service:	com.canon.meap.service.http.HttpService
Resources Used	
Storage:	10000 KB
Memory:	850 KB
Threads:	1
Sockets:	0
File Descriptors:	3

License Information

License Management

Status:	Installed
Serial Number:	XXXXXXXXXX
Expires after:	Does not Expire

Copyright CANON INC. 2011 All Rights Reserved

meap

Done Trusted sites | Protected Mode: Off 100%

? When [Authentication Information Settings] is displayed

Set the authentication information.

- "Setting Authentication Information for MEAP Applications"

MEAP Application License Settings

04L9-0FS

You can add, disable and delete license files for installed applications.

[➤ Adding License Files](#)

[➤ Disabling License Files](#)

[➤ Downloading Disabled License Files](#)

[➤ Deleting Disabled License Files](#)

IMPORTANT

Disabling Licenses

- You cannot disable a license file if the application is still running.
 - ["Stopping MEAP Applications"](#)
- When a disabled license file is generated, the status of that license file becomes <Not Installed> and the application becomes unusable.

Downloading and Deleting Licenses

- You can only download or delete disabled license files.
- Some license files need to be downloaded after they have been disabled.
- Once you have deleted the disabled license file, you cannot download it from the printer again. We recommend downloading and backing it up before deleting it.

Reinstalling License Files

You can reinstall disabled or downloaded license files in the same printer.

Adding License Files

04L9-0FU

You can install license files for applications that are already installed.

You can also increase counter values and extend terms of validity by adding license files.

1

Start SMS (Service Management Service).

➤ "Launching SMS (Log in)"

2

Click [MEAP Application Management].

The screenshot shows a web browser window displaying the Service Management Service interface. The page title is "Service Management Service". On the left, there is a navigation menu with "MEAP Application Management" highlighted. The main content area shows "MEAP Application Management" with a table of installed applications and a "Resource Information" section.

Application Name	Installed on	Status	License
LoginTool	2 01 00 09/21/2029	Started	Unnecessary
License Generator	4 4 0 09/21/2029	Installed	Installed

Resource Name	Amount Used	Remaining	Percent Used
Storage	13193 KB	19575 KB	40%
Memory	3700 KB	16780 KB	18%
Threads	11	117	9%
Sockets	6	122	5%
File Descriptors	7	121	5%

3

Click the name of the application to which a license file will be added.

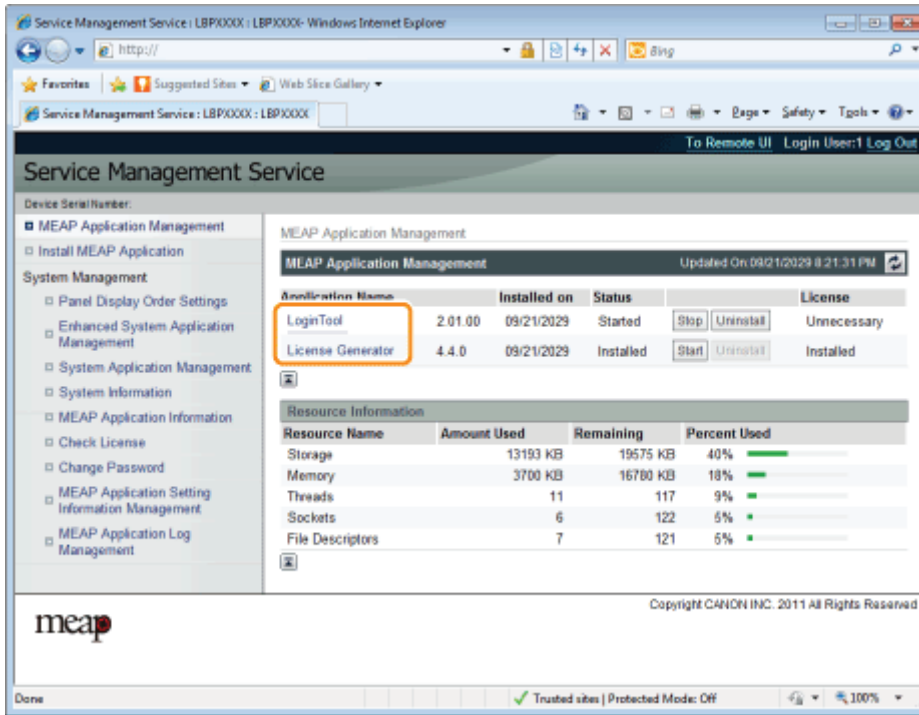

4

Click [License Management].

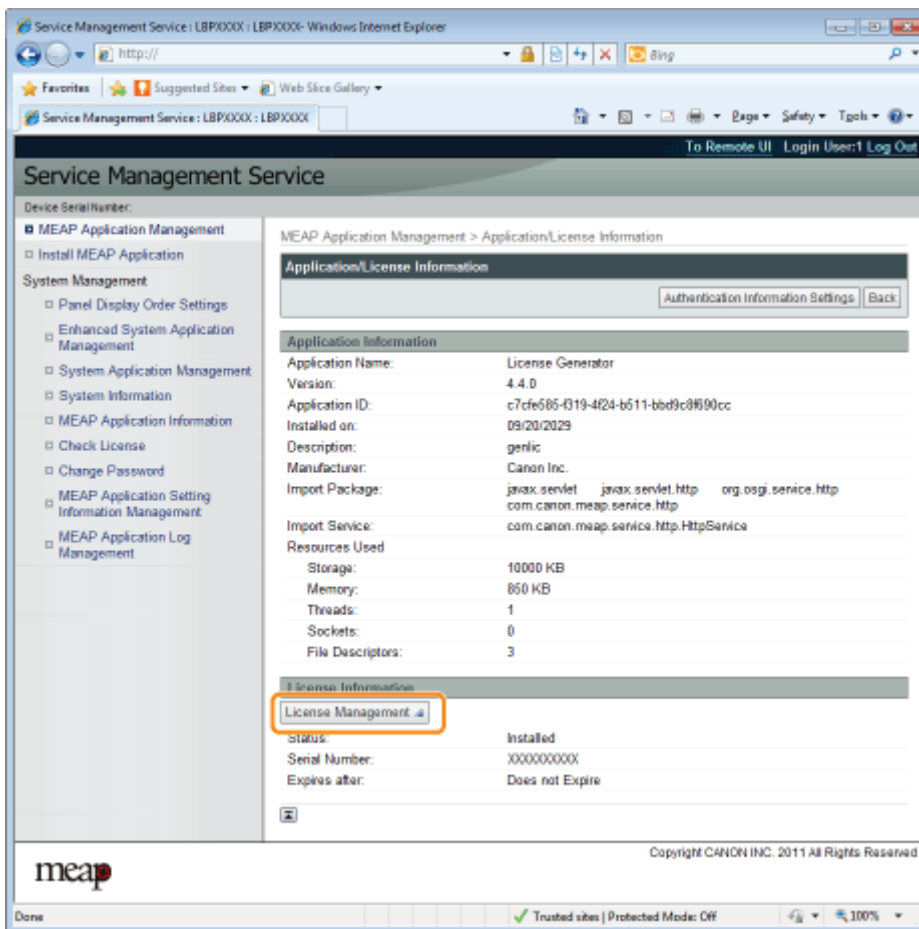

5

Specify the license file.

- (1) Click [Browse], and then select the license file to be added.
- (2) Click [Install].

6

Confirm the information on the install confirmation page, and then click [Yes].

→ The license file is installed.

? If you are adding a license file to an [Over Limit] or [Invalid] application you may need to restart the application.
➤ ["Starting/Stopping MEAP Applications"](#)

Disabling License Files

04L9-0FW

After you disable a license file, you can download and save it to a computer or delete it.

IMPORTANT

Disabling Licenses

- You cannot disable a license file if the application is still running.
 - "Stopping MEAP Applications"
- When a disabled license file is generated, the status of that license file becomes <Not Installed> and the application becomes unusable.

Reinstalling License Files

You can reinstall disabled license files in the same printer.

1

Start SMS (Service Management Service).

- "Launching SMS (Log in)"

2

Click [MEAP Application Management].

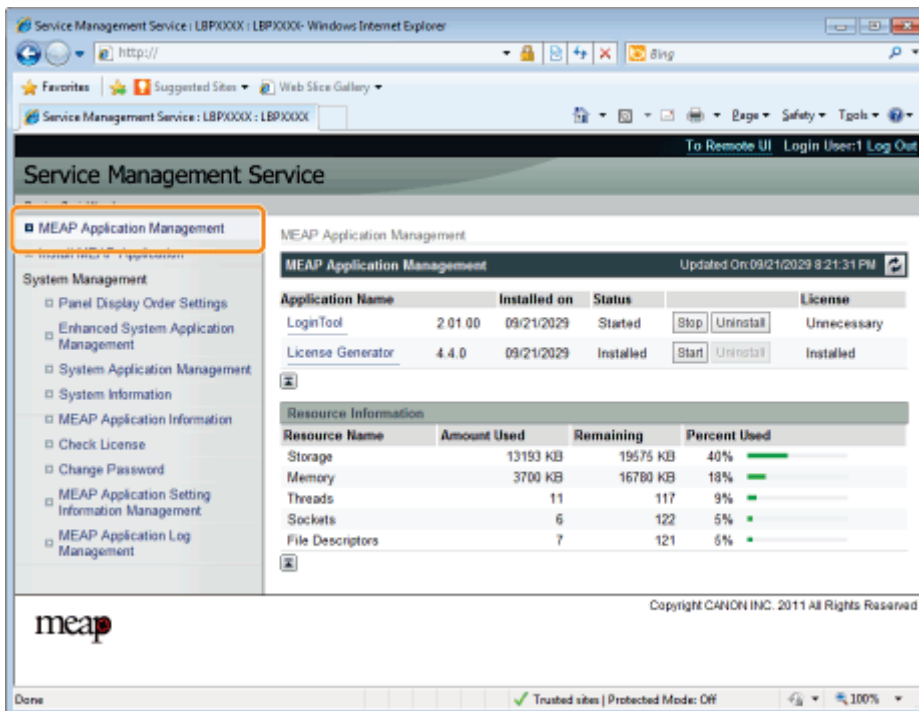

The screenshot shows the Service Management Service web interface. The left sidebar contains a navigation menu with "MEAP Application Management" highlighted. The main content area displays the "MEAP Application Management" page, which includes a table of installed applications and a resource information section.

Application Name	Installed on	Status	License
LoginTool	2 01 00 09/21/2029	Started	Unnecessary
License Generator	4.4.0 09/21/2029	Installed	Installed

Resource Name	Amount Used	Remaining	Percent Used
Storage	13193 KB	19575 KB	40%
Memory	3700 KB	16780 KB	18%
Threads	11	117	9%
Sockets	6	122	5%
File Descriptors	7	121	6%

3

Click the name of the application for which to disable to license file.

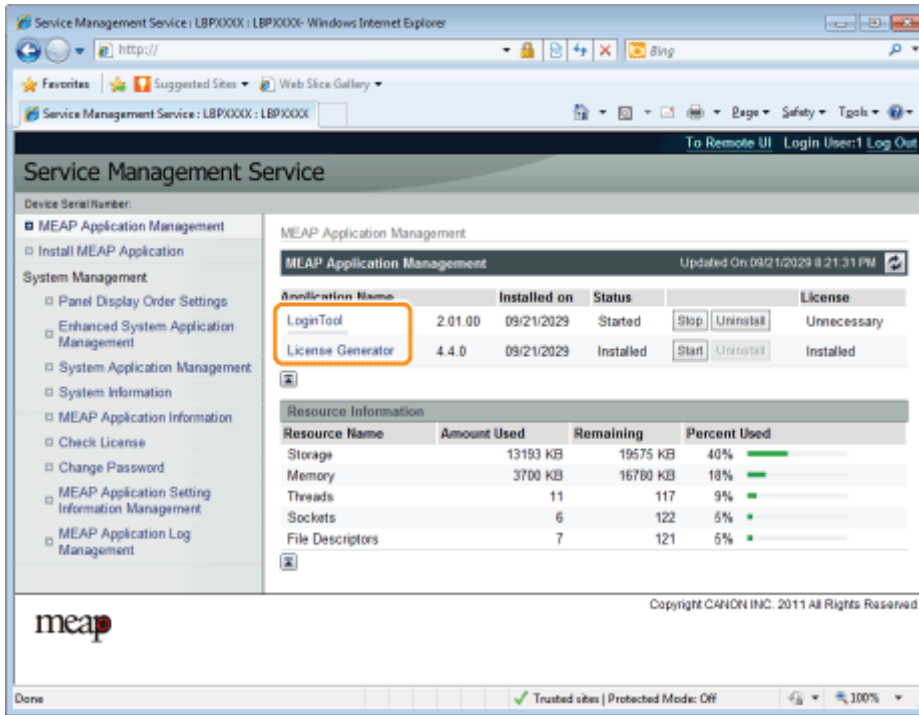

4

Click [License Management].

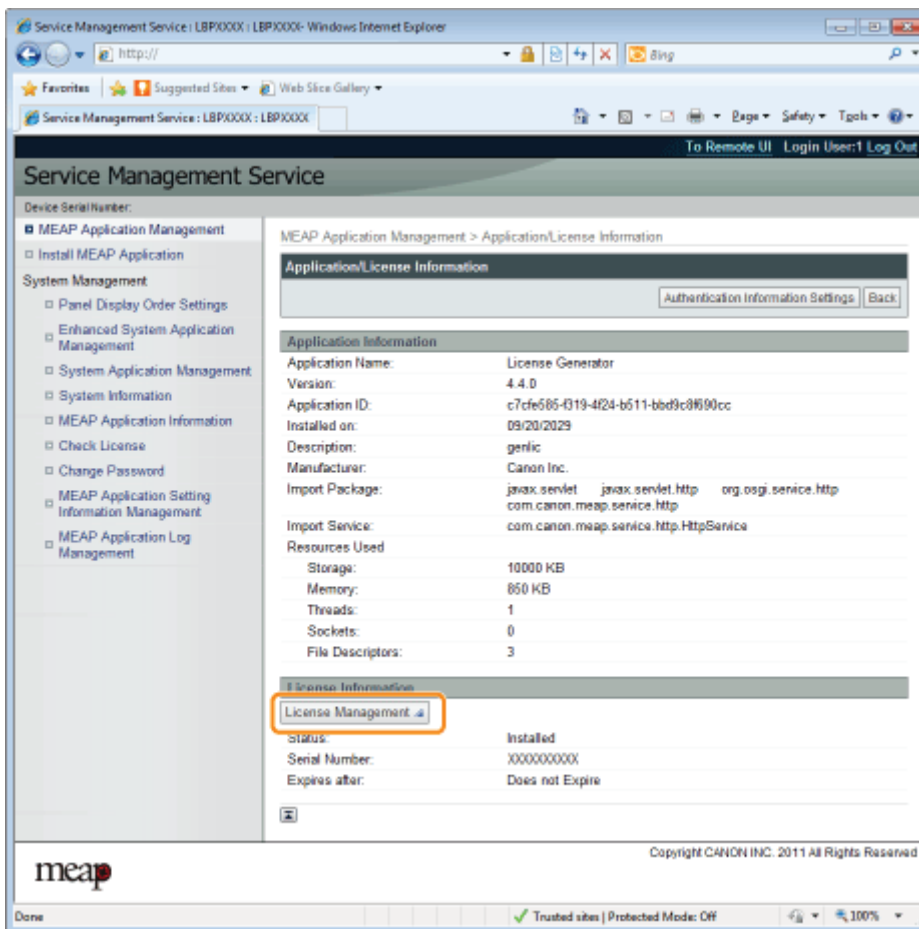

5

Click [Disable].

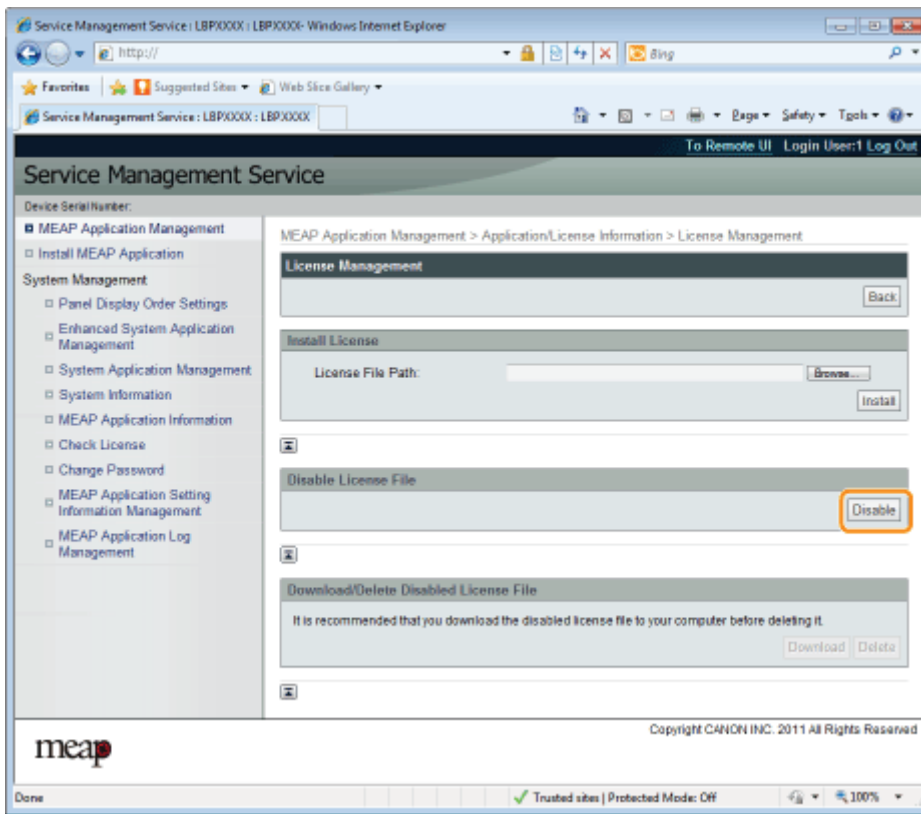

6

Click [Yes].

→ The license file is disabled.

Downloading Disabled License Files

04L9-0FX

Download and back up disabled license files to the computer.

IMPORTANT

Downloading Licenses

- You can only download disabled license files.
- Some license files need to be downloaded after they have been disabled.

Reinstalling License Files

You can reinstall downloaded and disabled license files in the same printer.

1

Start SMS (Service Management Service).

➤ "Launching SMS (Log in)"

2

Click [MEAP Application Management].

The screenshot shows the Service Management Service (SMS) web interface. The left sidebar contains a navigation menu with "MEAP Application Management" highlighted. The main content area displays the "MEAP Application Management" page, which includes a table of installed applications and a resource usage section.

Application Name	Installed on	Status	License
LoginTool	2.01.00 09/21/2029	Started	Unnecessary
License Generator	4.4.0 09/21/2029	Installed	Installed

Resource Name	Amount Used	Remaining	Percent Used
Storage	13193 KB	19575 KB	40%
Memory	3700 KB	16780 KB	18%
Threads	11	117	9%
Sockets	6	122	5%
File Descriptors	7	121	6%

3

Click the name of the application for which to download to license file.

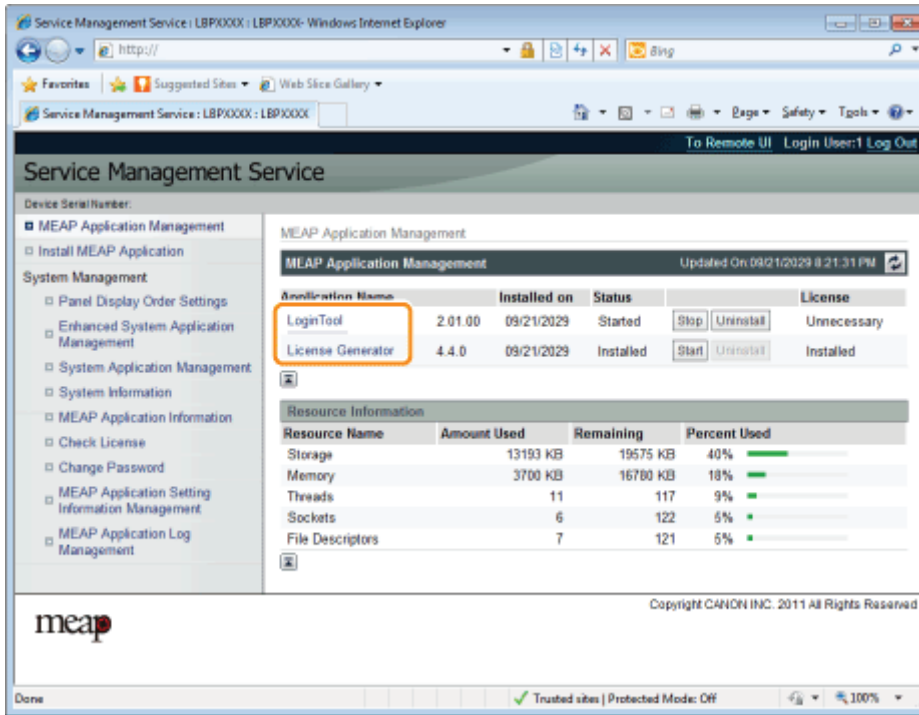

4

Click [License Management].

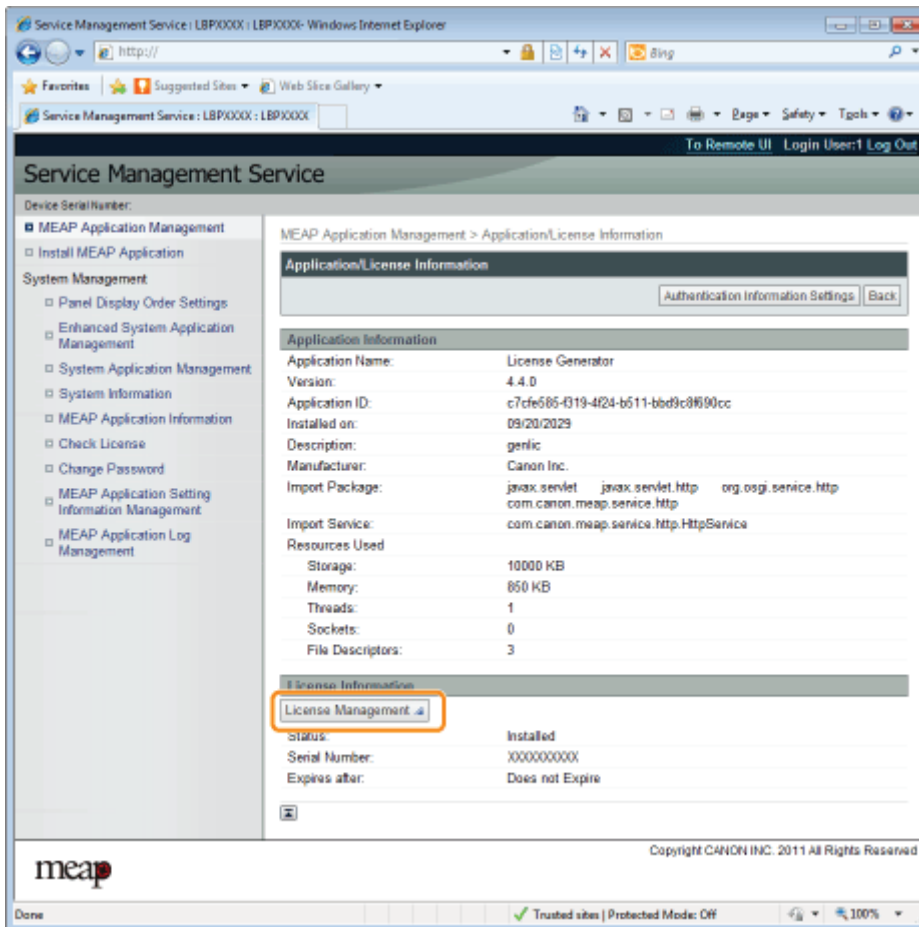

5

Click [Download].

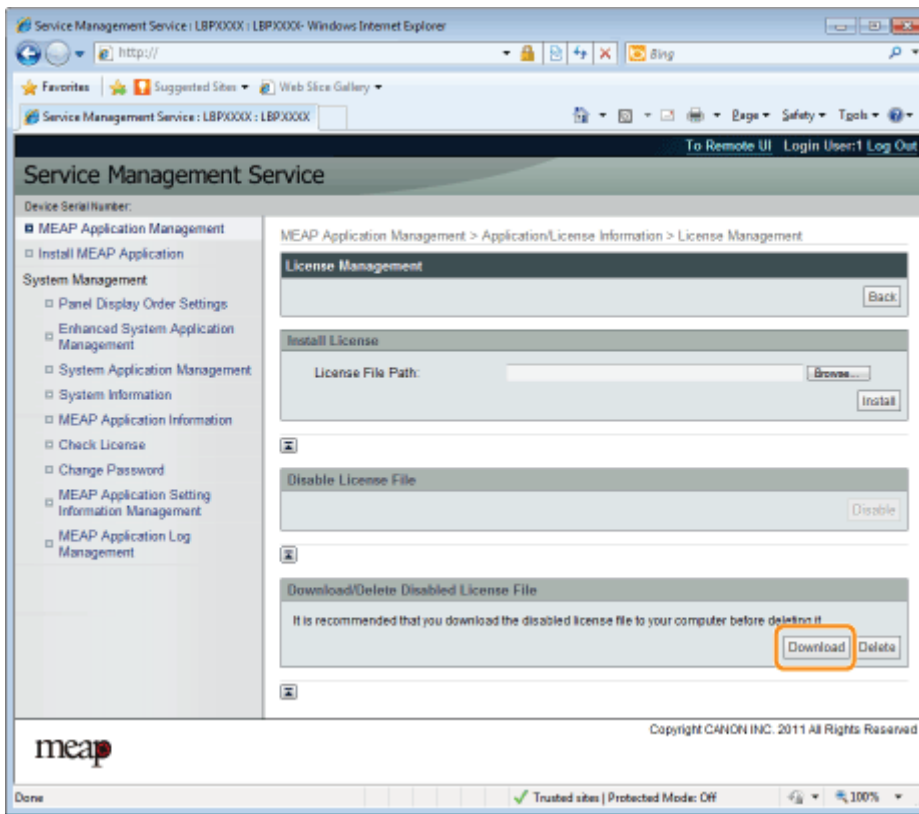

6

Follow the on-screen instructions and specify a file storage directory.

→ The license file is saved.

Deleting Disabled License Files

04L9-0FY

To uninstall an application, you must first delete the license file.

IMPORTANT

Deleting Licenses

- You can only delete disabled license files.
- Once you have deleted the disabled license file, you cannot download it again. We recommend downloading and backing it up before deleting it.

1

Start SMS (Service Management Service).

➤ "Launching SMS (Log in)"

2

Click [MEAP Application Management].

The screenshot shows a web browser window displaying the Service Management Service interface. The browser address bar shows "http://". The page title is "Service Management Service". The main content area is titled "MEAP Application Management" and includes a table of installed applications and a resource information section.

Application Name	Installed on	Status	License
LoginTool	2 01 00 09/21/2029	Started	Unnecessary
License Generator	4 4 0 09/21/2029	Installed	Installed

Resource Name	Amount Used	Remaining	Percent Used
Storage	13193 KB	19575 KB	40%
Memory	3700 KB	16780 KB	18%
Threads	11	117	9%
Sockets	6	122	5%
File Descriptors	7	121	5%

3

Click the name of the application to which to delete a license file.

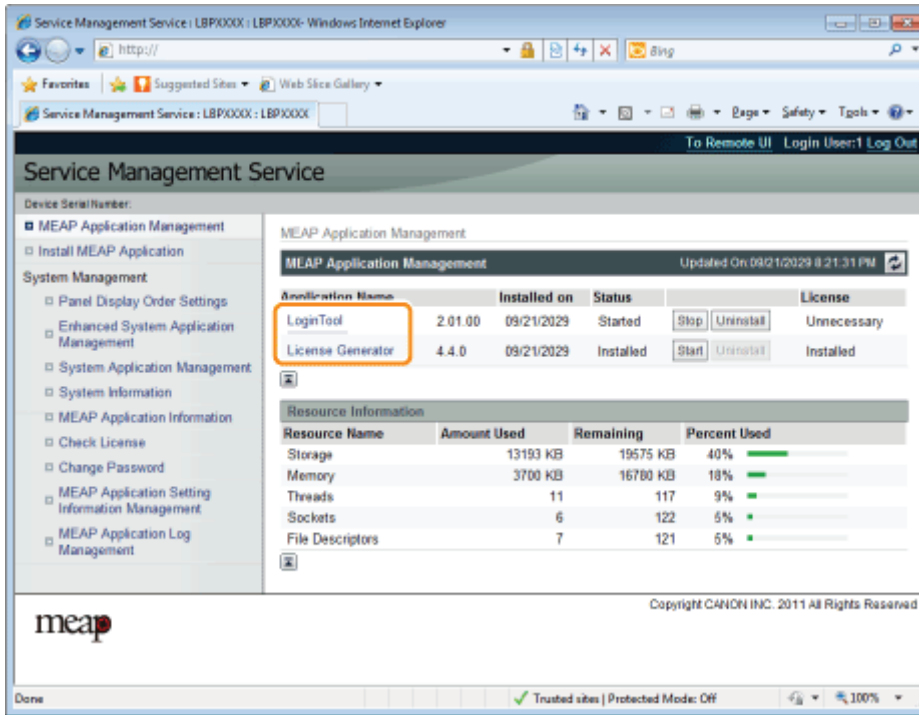

4

Click [License Management].

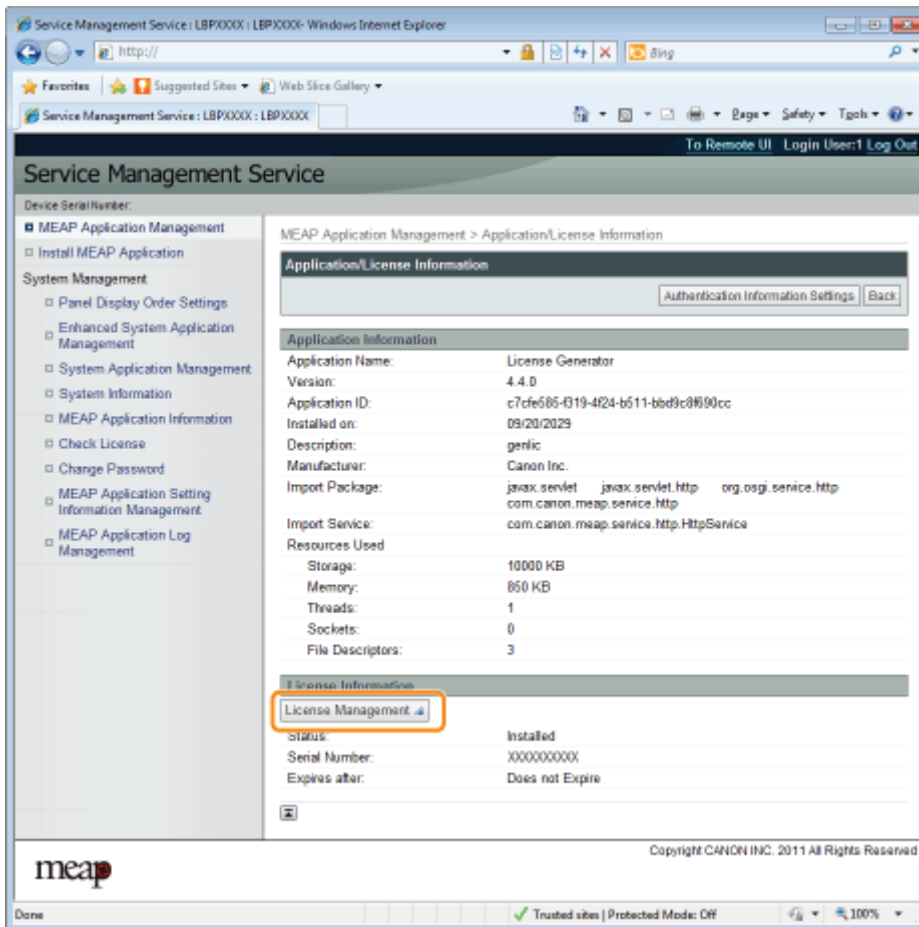

5

Click [Delete].

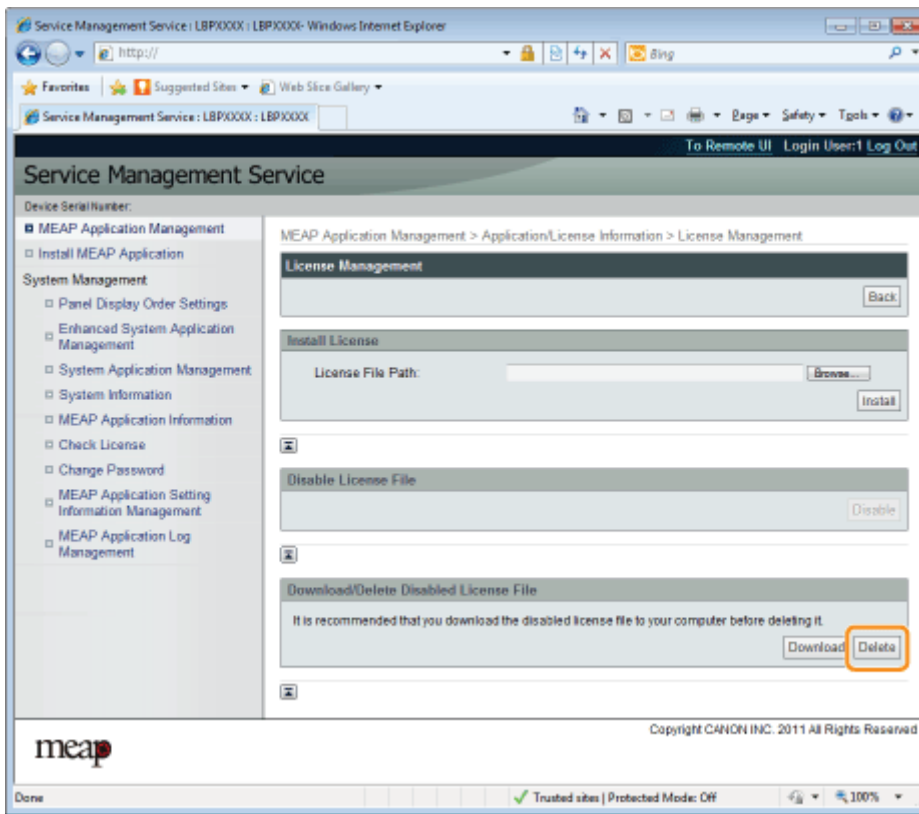

6

Click [Yes].

→ The license file is deleted.

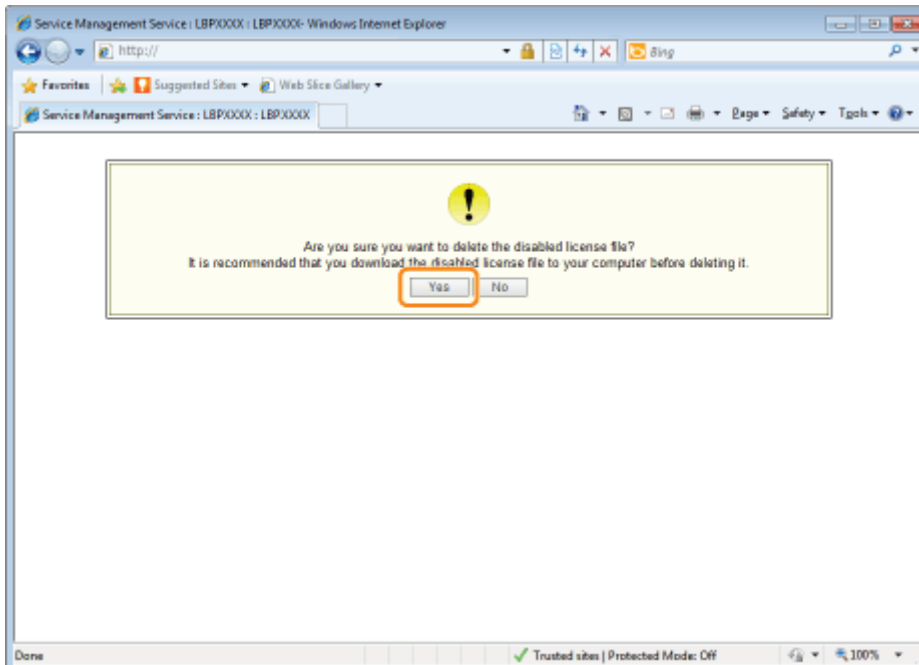

Setting Authentication Information for MEAP Applications

04L9-0H0

When processing jobs from applications that do not require operation from the printer, you must first set the authentication information.

1

Start SMS (Service Management Service).

❖ "Launching SMS (Log in)"

2

Click [MEAP Application Management].

The screenshot shows the Service Management Service web interface in Internet Explorer. The browser address bar shows 'http://'. The page title is 'Service Management Service'. The main content area is titled 'MEAP Application Management' and includes a table of installed applications and a resource usage section.

Application Name	Installed on	Status	License
LoginTool	2 01 00 09/21/2029	Started	Unnecessary
License Generator	4.4.0 09/21/2029	Installed	Installed

Resource Name	Amount Used	Remaining	Percent Used
Storage	13193 KB	19575 KB	40%
Memory	3700 KB	16780 KB	18%
Threads	11	117	9%
Sockets	6	122	5%
File Descriptors	7	121	6%

3

Click the name of the application for which to set authentication information.

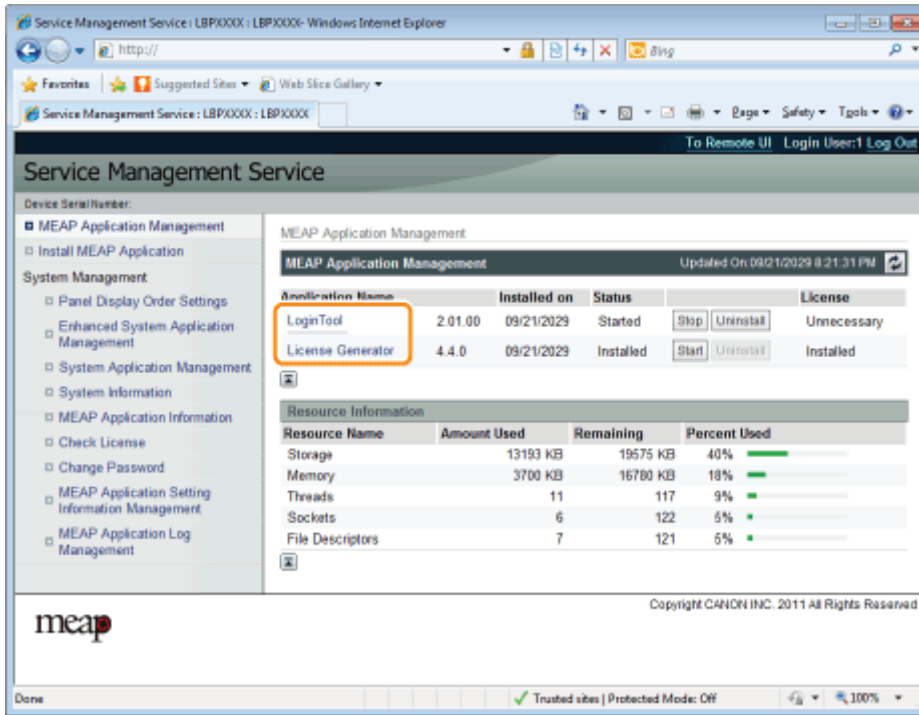

4

Click [Authentication Information Settings].

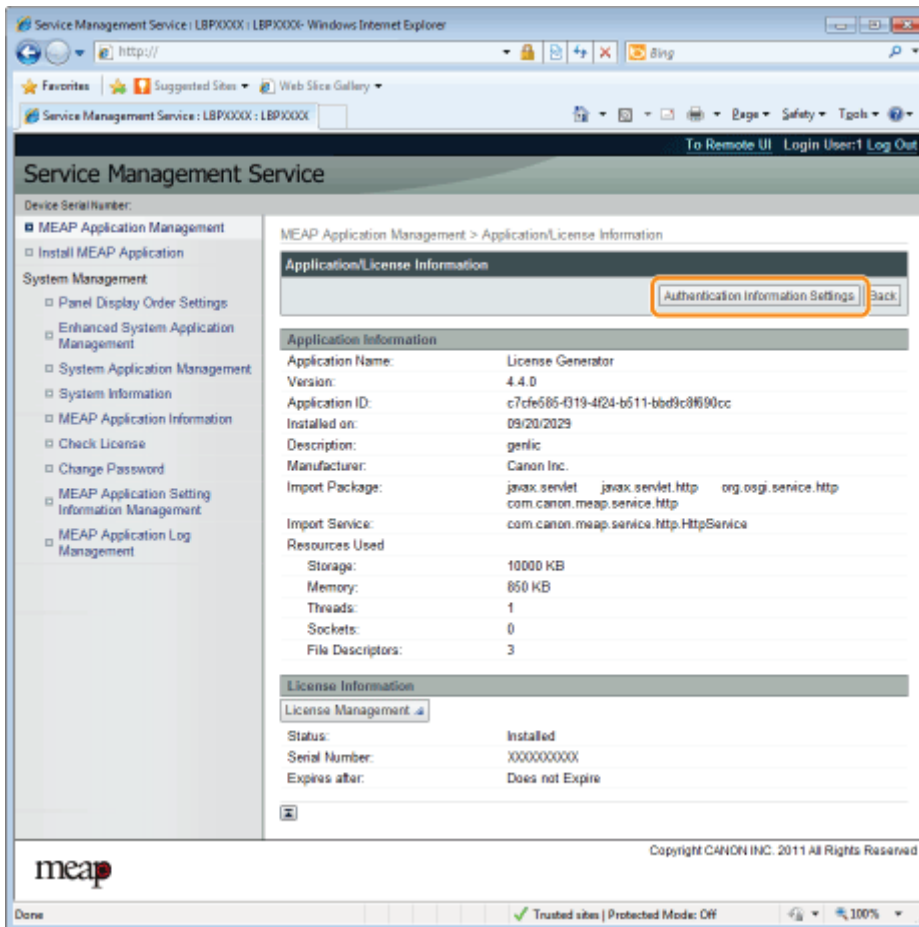

5

Enter the authentication information.

If you use department ID management

Enter the department ID and password in the fields marked [Department ID] and [PIN].

If you do not use department ID management

Enter an arbitrary ID and password in the fields marked [Department ID] and [PIN].

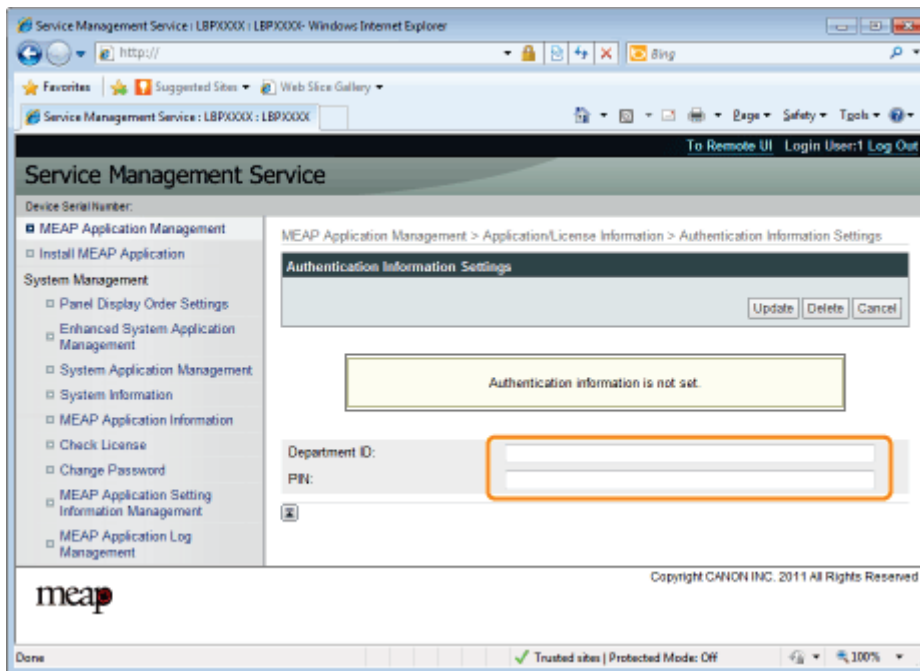

6

Click [Update].

→ Authentication information is set.

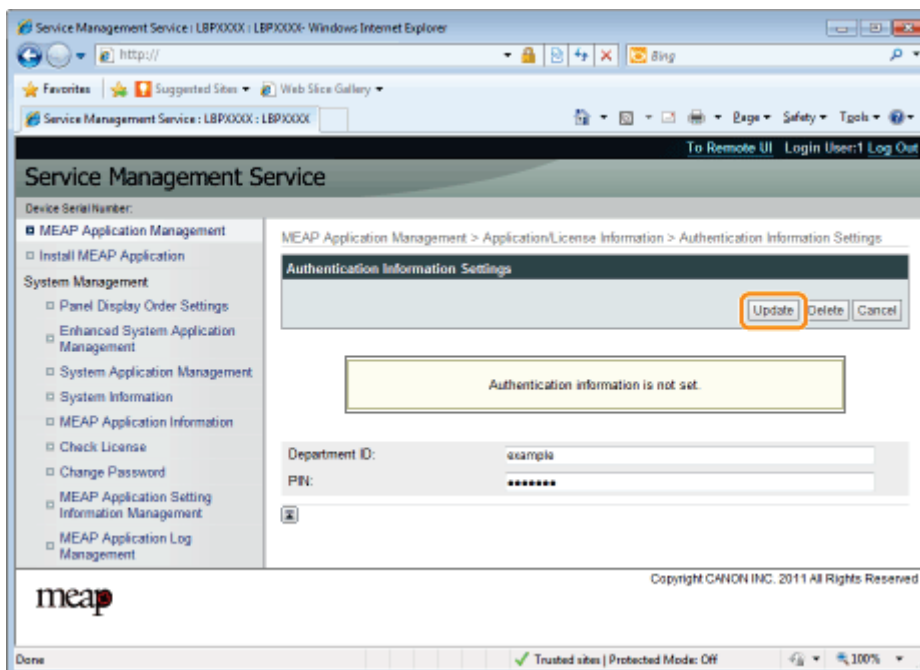

IMPORTANT

When cancelling authentication information

Click [Delete].

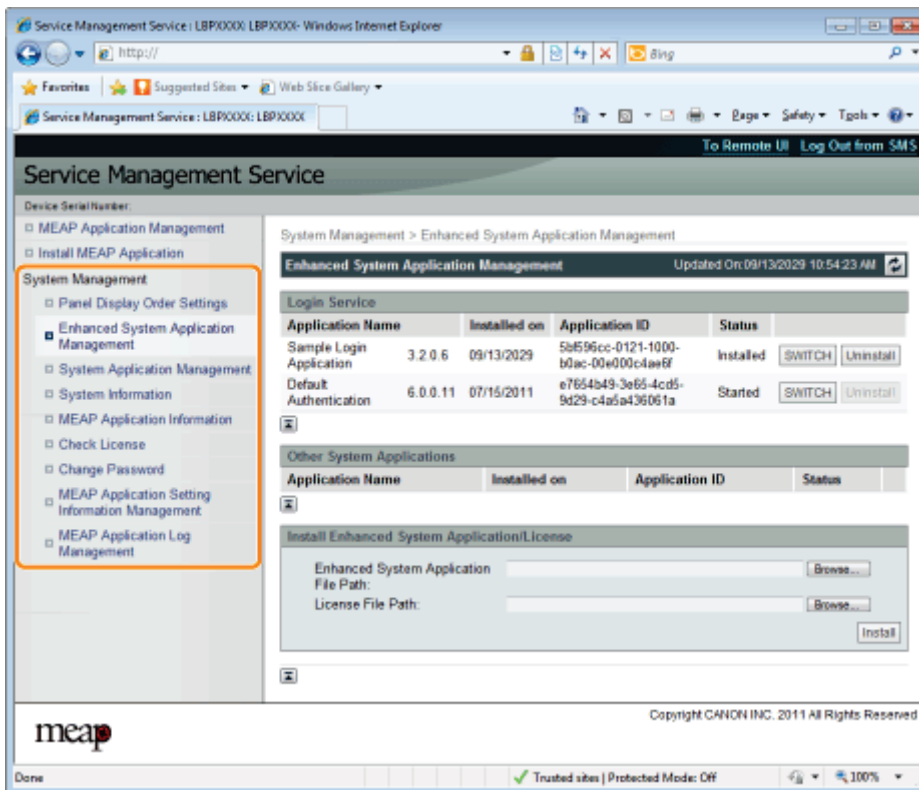

The [System Management] menu contains the following items.



[Panel Display Order Settings]	It sets the order MEAP applets are displayed on the operation panel. ❖ "Changing the MEAP Applet Display Order"
[Enhanced System Application Management]	It displays enhanced system application status and performs settings. You can also set log in service settings. ❖ "Setting Enhanced System Applications"
[System Application Management]	It displays system application status and performs start/stop operations.
[System Information]	It displays versions and system application information, etc. ❖ "Checking System Information"
[MEAP Application Information]	It displays the details about MEAP applications. ❖ "Checking Application Information"
[Check License]	It checks the content of the license file before it is installed. ❖ "Checking License Files"
[Change Password]	It changes the SMS log in password. ❖ "Changing the SMS Password"
[MEAP Application Setting Information Management]	It deletes the details about MEAP applications. ❖ "Deleting the MEAP Application Setting Information"
[MEAP Application Log Management]	It downloads and deletes log data obtained by MEAP applications. ❖ "Managing MEAP Application Log Data"

Changing the MEAP Applet Display Order

04L9-0HK

The applet display order changes when you press [] ( : Application) on the control panel.



1

Start SMS (Service Management Service).

➤ "Launching SMS (Log in)"

2

Click [Panel Display Order Settings].

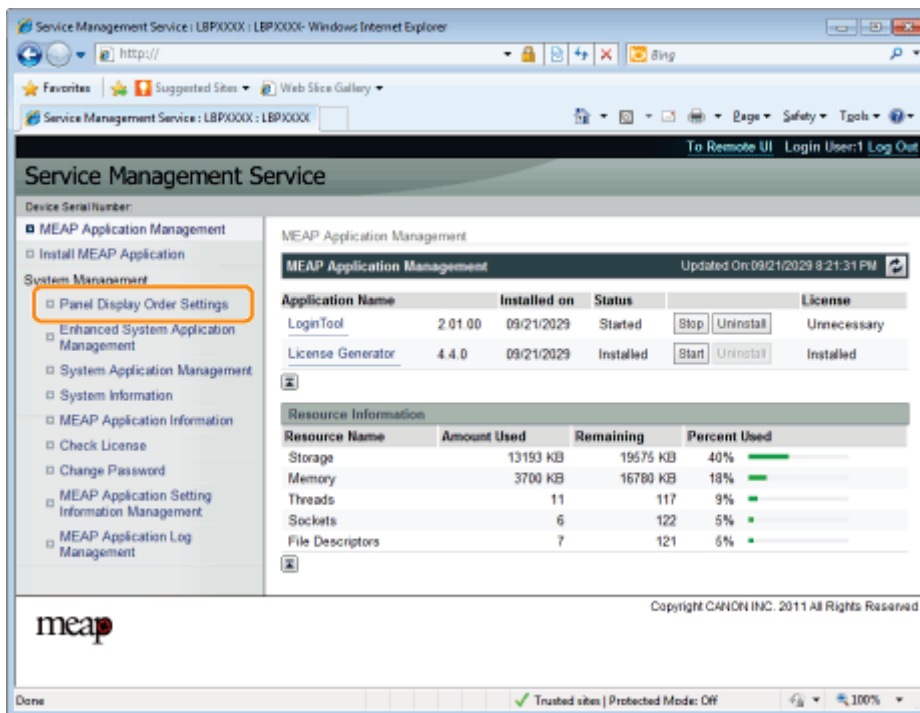

Service Management Service | LBPXXXX : LBPXXXX - Windows Internet Explorer

http://

Service Management Service : LBPXXXX : LBPXXXX

Service Management Service

Device Serial Number:

- MEAP Application Management
 - Install MEAP Application
- System Management
 - Panel Display Order Settings**
 - Enhanced System Application Management
 - System Application Management
 - System Information
 - MEAP Application Information
 - Check License
 - Change Password
 - MEAP Application Setting Information Management
 - MEAP Application Log Management

MEAP Application Management

Updated On: 09/21/2029 8:21:31 PM

Application Name	Installed on	Status	License
LoginTool	2.01.00 09/21/2029	Started	Unnecessary
License Generator	4.4.0 09/21/2029	Installed	Installed

Resource Information

Resource Name	Amount Used	Remaining	Percent Used
Storage	13193 KB	19575 KB	40%
Memory	3700 KB	16780 KB	18%
Threads	11	117	9%
Sockets	6	122	5%
File Descriptors	7	121	5%

Copyright CANON INC. 2011 All Rights Reserved

meap

Done Trusted sites | Protected Mode: Off 100%

3

Select the check boxes for the applets whose display order you wish to change.

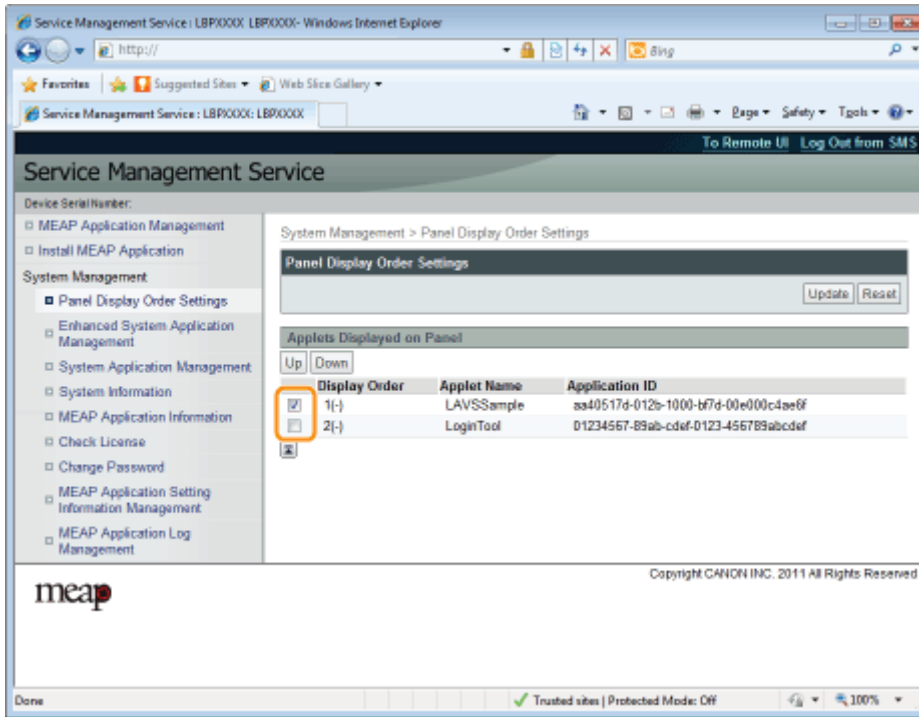

4

The display order changes.

- (1) Move the applets up and down by clicking [Up] and [Down].
- (2) Click [Update].

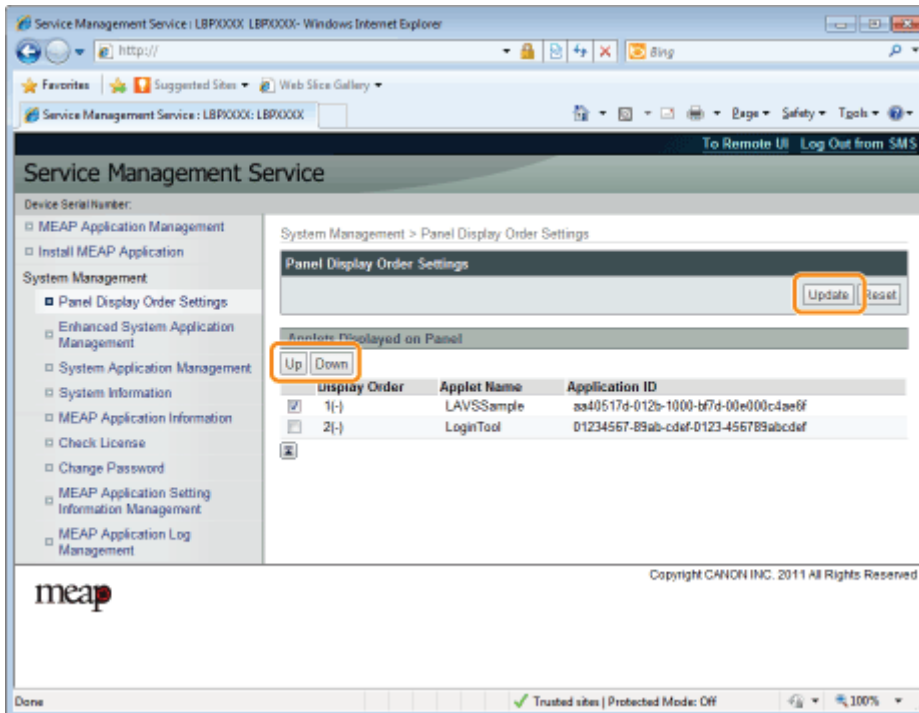

Checking Login Services

04L9-0H4

Check the login services that perform user authentication.

1

Start SMS (Service Management Service).

❖ "Launching SMS (Log in)"

2

Click [Enhanced System Application Management].

The screenshot displays the Service Management Service web interface in a Windows Internet Explorer browser. The page title is "Service Management Service" and the URL is "http://". The interface includes a navigation menu on the left with the following items: MEAP Application Management, Install MEAP Application, System Management, Panel Display Order Settings, Enhanced System Application Management (highlighted with an orange box), System Application Management, System Information, MEAP Application Information, Check License, Change Password, MEAP Application Setting Information Management, and MEAP Application Log Management. The main content area shows the "MEAP Application Management" section, updated on 09/21/2029 at 8:21:31 PM. It contains a table of applications:

Application Name	Installed on	Status	License
LoginTool	2.01.00 09/21/2029	Started	Unnecessary
License Generator	4.4.0 09/21/2029	Installed	Installed

Below the application table is a "Resource Information" section with a table showing system resource usage:

Resource Name	Amount Used	Remaining	Percent Used
Storage	13193 KB	19575 KB	40%
Memory	3700 KB	16780 KB	18%
Threads	11	117	9%
Sockets	6	122	5%
File Descriptors	7	121	6%

The interface also includes a "To Remote UI" link, "Login User:1", and "Log Out" link. The footer contains the "meap" logo and "Copyright CANON INC. 2011 All Rights Reserved".

3

Check the status of log in service.

Service Management Service | LBPXXXX: LBPXXXX - Windows Internet Explorer

http://

Service Management Service : LBPXXXX: LBPXXXX

To Remote UI | Log Out from SMS

Service Management Service

Device Serial Number:

- MEAP Application Management
- Install MEAP Application
- System Management**
 - Panel Display Order Settings
 - Enhanced System Application Management**
 - System Application Management
 - System Information
 - MEAP Application Information
 - Check License
 - Change Password
 - MEAP Application Setting Information Management
 - MEAP Application Log Management

System Management > Enhanced System Application Management

Enhanced System Application Management Updated On 09/13/2029 10:54:23 AM

Login Service

Application Name	Installed on	Application ID	Status	
Sample Login Application	3.2.0.6 09/13/2029	5b596cc-0121-1000-b0ac-00e00c4ee6f	Installed	SWITCH Uninstall
Default Authentication	6.0.0.11 07/15/2011	e7654b49-3e65-4cd5-9d29-c4a5a436061a	Started	SWITCH Uninstall

Other System Applications

Application Name	Installed on	Application ID	Status

Install Enhanced System Application/License

Enhanced System Application

File Path:

License File Path:

Copyright CANON INC. 2011 All Rights Reserved

meap

Done Trusted sites | Protected Mode: Off 100%

Setting Enhanced System Applications

04L9-0H5

They perform the operations of the enhanced system applications that enhance the system applications (the basic applications that make up the MEAP system).

Starting/Stopping Enhanced System Applications

- Starting Enhanced System Applications
- Stopping Enhanced System Applications

Installing Enhanced System Applications

Uninstalling Enhanced System Applications

Starting/Stopping Enhanced System Applications

04L9-0H6

↳ Starting Enhanced System Applications

↳ Stopping Enhanced System Applications

Starting Enhanced System Applications

04L9-0H7

1

Start SMS (Service Management Service).

➤ "Launching SMS (Log in)"

2

Click [Enhanced System Application Management].

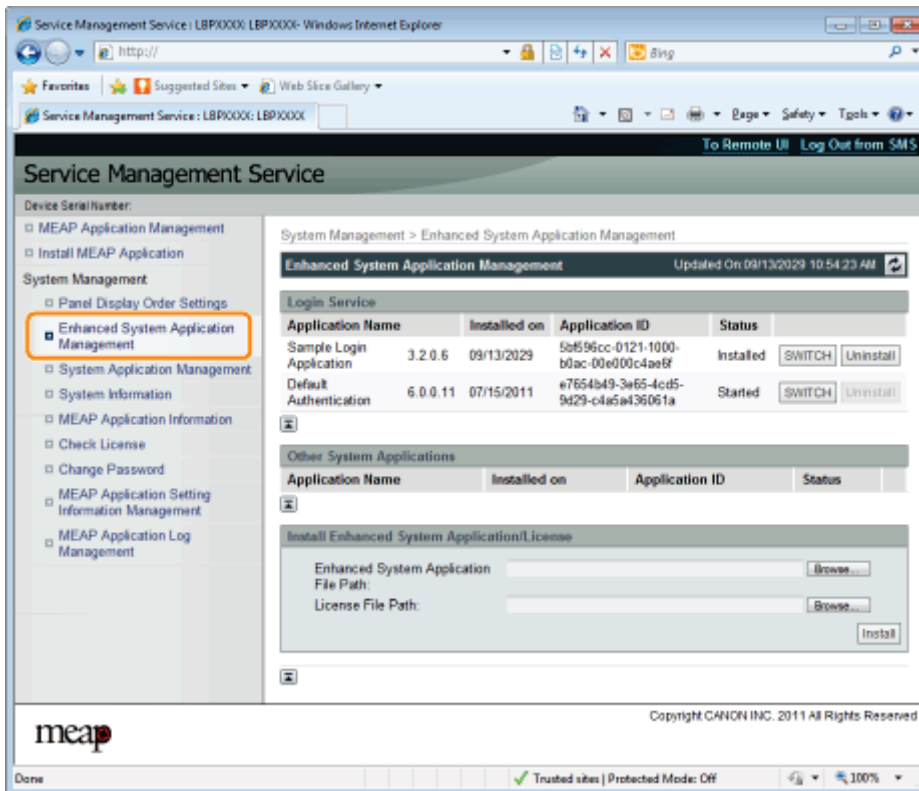

3

Click [Start] for Other System Applications, and then start the application.

When the [License Agreement] appears, confirm the information, and then click [I Accept].

Stopping Enhanced System Applications

04L9-0H8

1

Start SMS (Service Management Service).

➤ "Launching SMS (Log in)"

2

Click [Enhanced System Application Management].

The screenshot shows a web browser window displaying the Service Management Service interface. The page title is "Service Management Service" and the URL is "http://". The interface includes a navigation menu on the left with the following items:

- Device Serial Number:
- MEAP Application Management
- Install MEAP Application
- System Management
 - Panel Display Order Settings
 - Enhanced System Application Management** (highlighted with a red box)
 - System Application Management
 - System Information
- MEAP Application Information
- Check License
- Change Password
- MEAP Application Setting Information Management
- MEAP Application Log Management

The main content area displays "System Management > Enhanced System Application Management" and "Enhanced System Application Management" (Updated On 09/13/2029 10:54:23 AM). Below this is a table titled "Login Service" with the following data:

Application Name	Installed on	Application ID	Status	
Sample Login Application	3.2.0.6 09/13/2029	5b596cc-0121-1000-b1ac-00e00c4ae6f	Installed	[SWITCH] [Uninstall]
Default Authentication	6.0.0.11 07/15/2011	e7654b49-3e65-4cd5-9d29-c4a5a136d61a	Started	[SWITCH] [Uninstall]

Below the table is a section titled "Other System Applications" with a table structure:

Application Name	Installed on	Application ID	Status
------------------	--------------	----------------	--------

At the bottom of the main content area is a section titled "Install Enhanced System Application/License" with input fields for "Enhanced System Application File Path:" and "License File Path:", each with a "Browse..." button, and an "Install" button.

The footer of the page includes the "meap" logo and the text "Copyright CANON INC. 2011 All Rights Reserved".

3

Click [Stop] for Other System Applications, and then stop the application.

Installing Enhanced System Applications

04L9-0H9

1

Start SMS (Service Management Service).

➤ "Launching SMS (Log in)"

2

Click [Enhanced System Application Management].

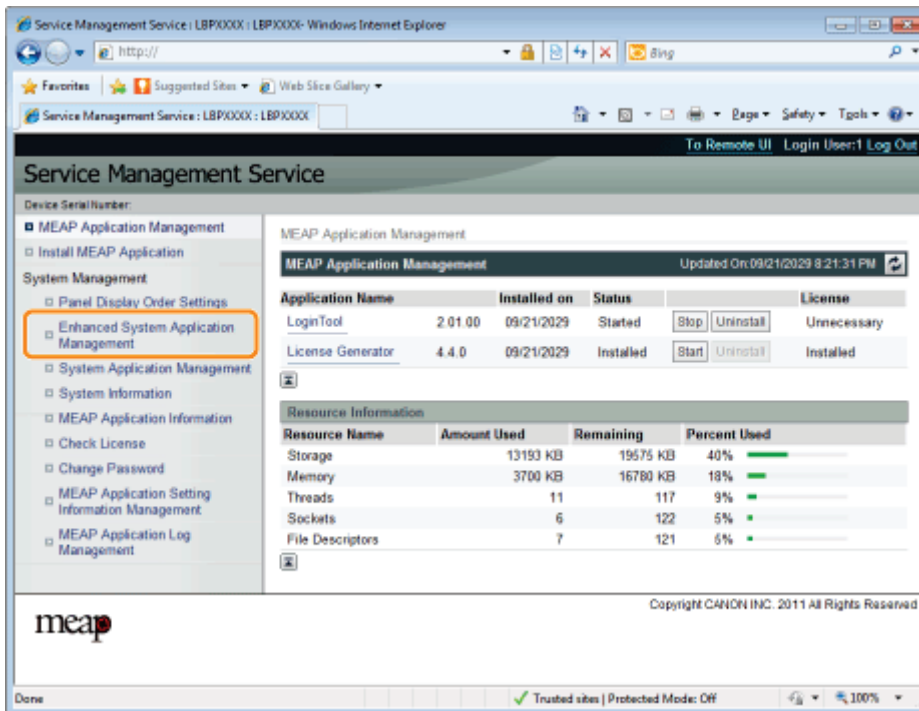

The screenshot shows the Service Management Service web interface in Internet Explorer. The browser address bar shows 'http://'. The page title is 'Service Management Service: LBPXXXX: LBPXXXX'. The main content area is titled 'Service Management Service' and includes a navigation menu on the left. The 'Enhanced System Application Management' option is highlighted with an orange box. The main content area displays 'MEAP Application Management' with a table of installed applications and a 'Resource Information' section.

Application Name	Installed on	Status	License
LoginTool	2.01.00 09/21/2029	Started	Unnecessary
License Generator	4.4.0 09/21/2029	Installed	Installed

Resource Name	Amount Used	Remaining	Percent Used
Storage	13193 KB	19575 KB	40%
Memory	3700 KB	16780 KB	18%
Threads	11	117	9%
Sockets	6	122	5%
File Descriptors	7	121	5%

3

Set [Enhanced System Application File Path] and [License File Path].

Either select the file by clicking [Browse...], or enter the location where the file is stored.

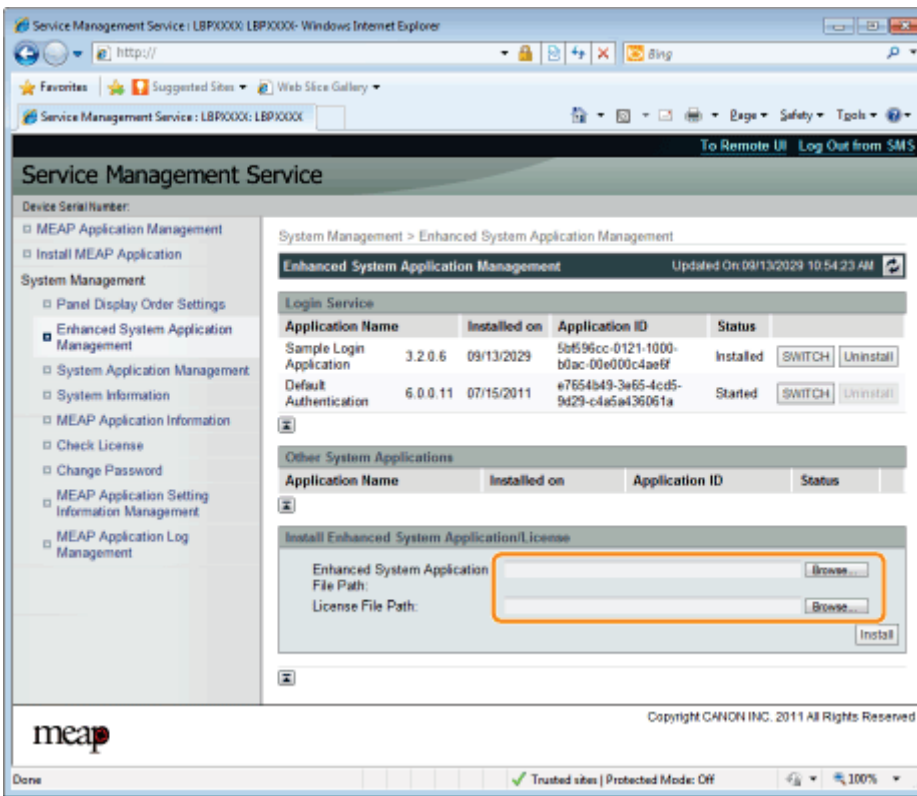

[Enhanced System Application File Path]	Specify a file with a "jar" extension.
[License File Path]	Specify a file with a "lic" extension.

IMPORTANT

When specifying a file

Specify both the application file and the license file.

4

Click [Install].

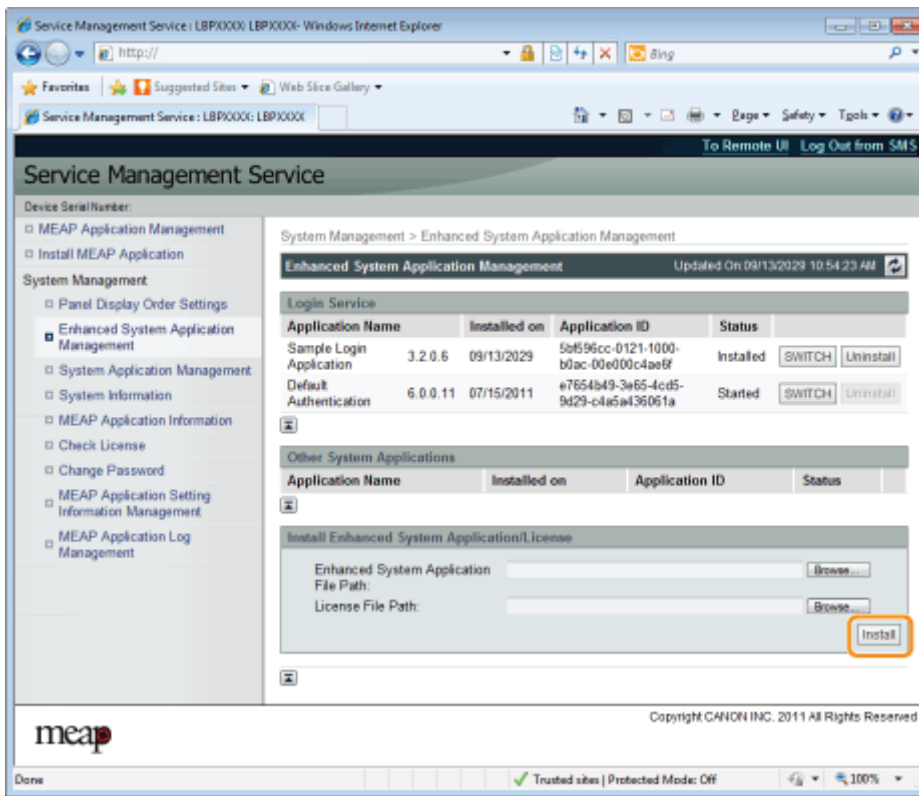

5

Confirm the information on the install confirmation page, and then click [Yes].

When the [License Agreement] appears, confirm the information, and then click [I Accept].

→ The installation begins.

Uninstalling Enhanced System Applications

04L9-0HA

NOTE

Deleting License Files

There is no need to delete license files before uninstalling enhanced system applications.

1

Start SMS (Service Management Service).

➤ "Launching SMS (Log in)"

2

Click [Enhanced System Application Management].

The screenshot shows the Service Management Service web interface. The left sidebar contains a navigation menu with the following items: MEAP Application Management, Install MEAP Application, System Management, Panel Display Order Settings, Enhanced System Application Management (highlighted with an orange box), System Application Management, System Information, MEAP Application Information, Check License, Change Password, MEAP Application Setting Information Management, and MEAP Application Log Management. The main content area is titled 'MEAP Application Management' and includes a table of installed applications:

Application Name	Installed on	Status	License
LoginTool	2.01.00 09/21/2029	Started	Unnecessary
License Generator	4.4.0 09/21/2029	Installed	Installed

Below the application table is a 'Resource Information' table:

Resource Name	Amount Used	Remaining	Percent Used
Storage	13193 KB	19575 KB	40%
Memory	3700 KB	16780 KB	18%
Threads	11	117	9%
Sockets	6	122	5%
File Descriptors	7	121	6%

The interface also shows a copyright notice for CANON INC. 2011 and a status bar at the bottom indicating 'Trusted sites | Protected Mode: Off'.

3

Click [Uninstall] for the application to uninstall.

† Applications with [Uninstall] grayed out cannot be deleted.

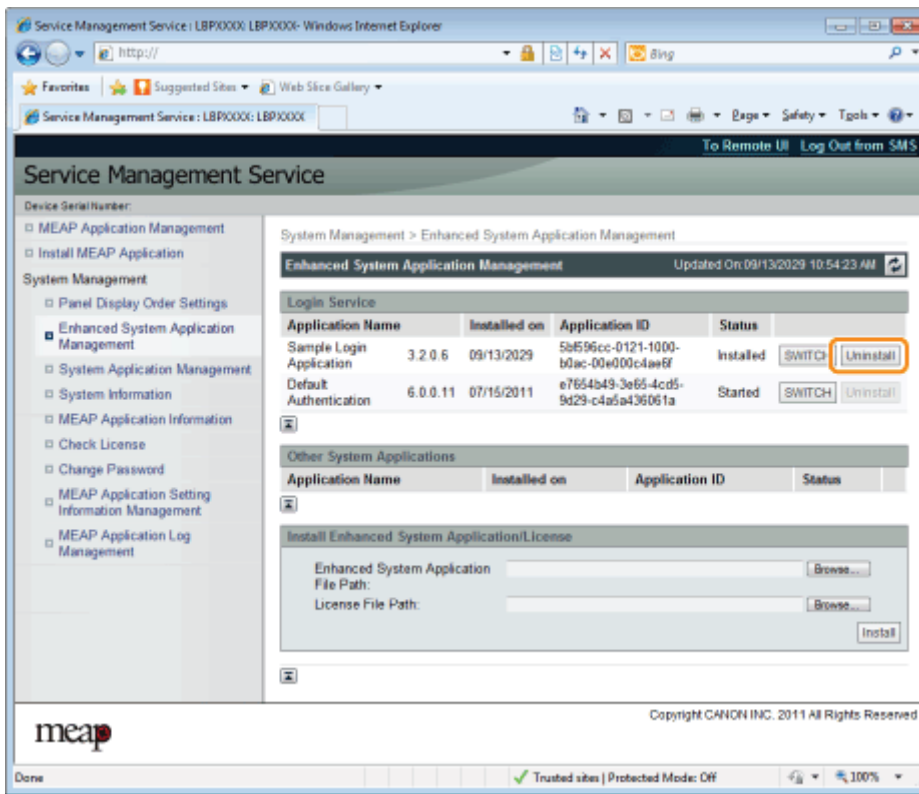

4

Click [Yes].

→ The uninstall begins.

Checking Information

04L9-0HC

[↳ Checking System Information](#)

[↳ Checking Application Information](#)

[↳ Checking License Files](#)

Checking System Information

04L9-0HE

You can check the version information of platforms such as Java virtual machine and version information, date of installation and status of system applications.

1

Start SMS (Service Management Service).

❖ "Launching SMS (Log in)"

2

Click [System Information].

The screenshot shows a web browser window displaying the Service Management Service interface. The browser address bar shows 'http://'. The page title is 'Service Management Service'. The main content area is titled 'System Management > System Information' and 'System Information' (Updated On: 08/21/2011 9:22:07 PM). The interface is divided into two main sections: 'Platform Information' and 'System Application Information'. The 'Platform Information' section contains a table with columns 'Name' and 'Version'. The 'System Application Information' section contains a table with columns 'Application Name', 'Installed on', 'Application ID', and 'Status'. The 'System Information' link in the left sidebar is highlighted with a red box.

Name	Version
MEAP Specifications	15.16.19.25.26.27.29.34.39.45.47.50.51.52.54.55.57.58.60.61.62.63.74
MEAP Contents	01.32
Java Virtual Machine	06.00.3

Application Name	Installed on	Application ID	Status
DSL Installer Service	3.0.4.6 07/15/2011	2ca34a18-778a-4fd9-bde9-511a2963b733	Started
SMS Installer Service	3.1.0.27 07/15/2011	c70590d0-c691-49ef-9c23-3d9e452194de	Started
Service Management Service	2.11.0.13 07/15/2011	c6b78400-9a49-45a7-a08a-9aa353e62287	Started

Click [Display Details] to check detailed information.

Service Management Service | LBPXXXX | LBPXXXX - Windows Internet Explorer

http://

Service Management Service : LBPXXXX : LBPXXXX

To Remote UI | Login User:1 | Log Out

Service Management Service

Device Serial Number:

- MEAP Application Management
- Install MEAP Application

System Management

- Panel Display Order Settings
- Enhanced System Application Management
- System Application Management
- System Information**
- MEAP Application Information
- Check License
- Change Password
- MEAP Application Setting Information Management
- MEAP Application Log Management

System Management > System Information

System Information Updated On: 09/21/2019 9:22:07 PM

Platform Information

Name	Version
MEAP Specifications	15.18.19.25.26.27.29.34.39.45.47.50.51.52.54.55.57.58.60.61.62.63.74
MEAP Contents	01.32
Java Virtual Machine	06.00.3

System Application Information

Display Details

Application Name	Version	Installed on	Application ID	Status
DSL Installer Service	3.0.4.6	07/15/2011	2ca34a18-7f8a-4fd9-8de9-511a2963b733	Started
SMS Installer Service	3.1.0.27	07/15/2011	c70590d0-c691-49ef-9c23-3d9e452194db	Started
Service Management Service	2.11.0.13	07/15/2011	c6b78400-9a49-45a7-a08a-9aa393e62287	Started

Copyright CANON INC. 2011 All Rights Reserved

meap

Done Trusted sites | Protected Mode: Off 100%

Checking Application Information

04L9-0HF

You can check the information about installed or uninstalled applications (except for system applications).

1

Start SMS (Service Management Service).

❖ "Launching SMS (Log in)"

2

Click [MEAP Application Information].

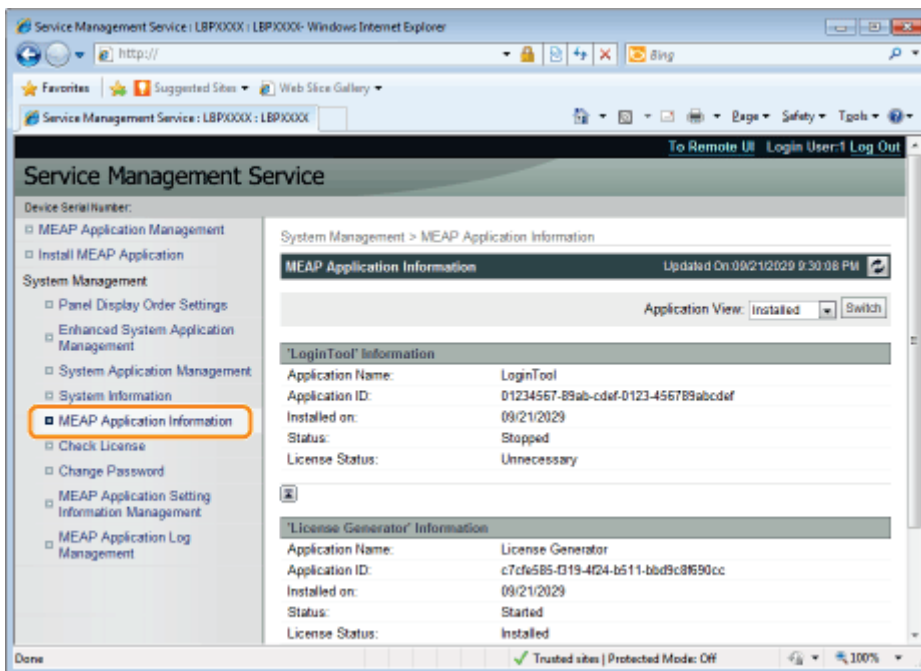

3

Information about applications is displayed.

- (1) Select [Installed] or [Uninstalled].
- (2) Click [Switch].

[Installed]	Information about installed applications (except for system applications) is displayed.
[Uninstalled]	Information about uninstalled applications (except for system applications) is displayed.

Checking License Files

04L9-0HH

You can check the content of the license file before it is installed.

1

Start SMS (Service Management Service).

➤ "Launching SMS (Log in)"

2

Click [Check License].

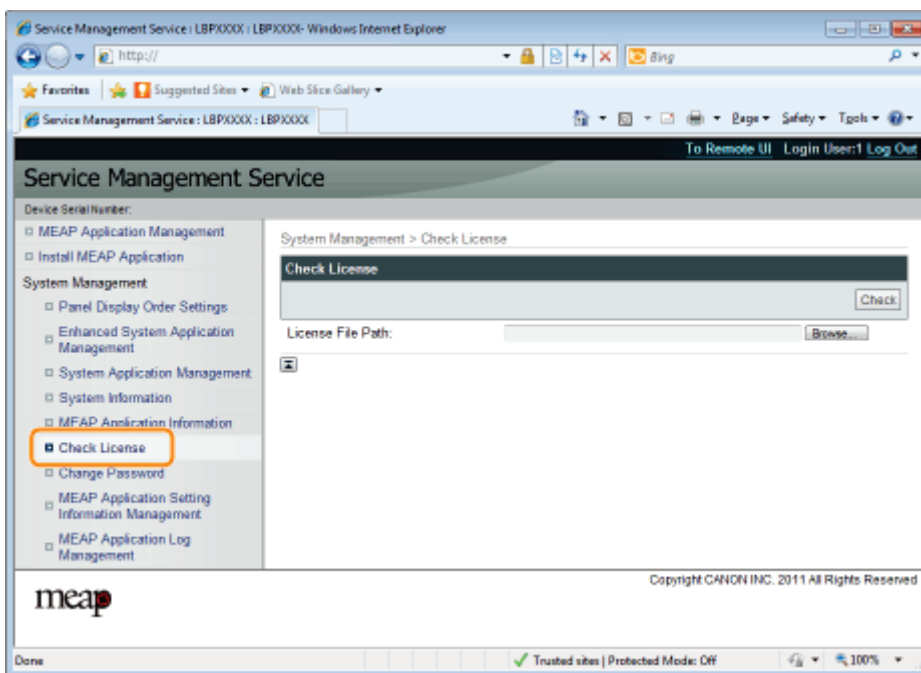

3

Either select the file by clicking [Browse], or enter the location where the file is stored.

4

Click [Check].

→ The content of the license file is displayed.

Changing the SMS Password

04L9-0HJ

IMPORTANT

SMS Password

- To prevent unauthorized access, We recommend that the administrator change the password before SMS use is begun.
- This password is to prevent unauthorized operation of the printer. Do not let anyone know except the administrator.
- Make sure that you do not forget your password. If you forget your password, you will not be able to use SMS. If this happens, contact your local dealer.

1

Start SMS (Service Management Service).

➤ "Launching SMS (Log in)"

2

Click [Change Password].

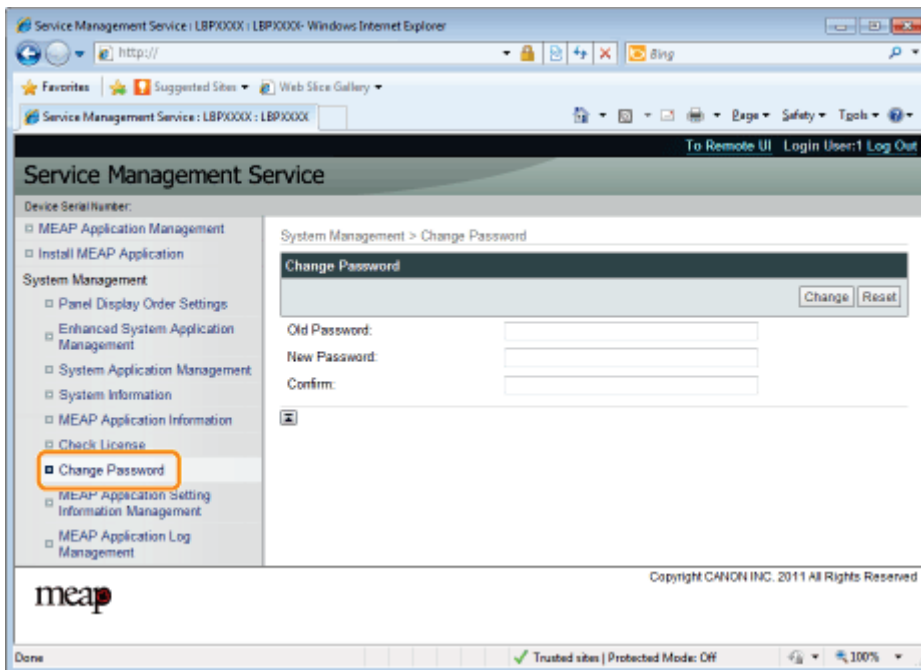

3

Set the password.

- (1) Set the password.
- (2) Click [Change].

† Enter between 8 and 32 alphanumeric characters (a to z, A to Z, and 0 to 9) for the password.

[Old Password]	Enter the password that is currently used.
----------------	--

[New Password]	Enter the new password.
[Confirm]	Enter the same password again in [New Password].

Deleting the MEAP Application Setting Information

04L9-OHL

Deletes the application data.

1

Start SMS (Service Management Service).

❖ "Launching SMS (Log in)"

2

Click [MEAP Application Setting Information Management].

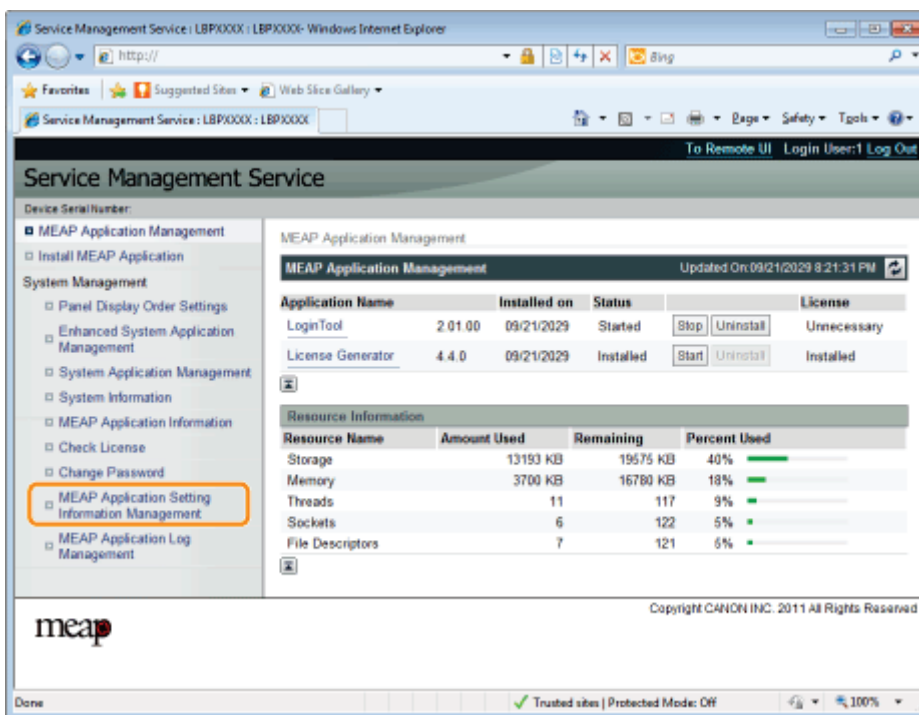

The screenshot shows the Service Management Service web interface in a Windows Internet Explorer browser. The page title is "Service Management Service" and the URL is "http://". The interface includes a navigation menu on the left with the following items: MEAP Application Management (selected), Install MEAP Application, System Management (with sub-items: Panel Display Order Settings, Enhanced System Application Management, System Application Management, System Information), MEAP Application Information (with sub-items: Check License, Change Password, MEAP Application Setting Information Management (highlighted with an orange box), MEAP Application Log Management), and MEAP Application Log Management. The main content area displays "MEAP Application Management" with a table of installed applications:

Application Name	Installed on	Status	License
LoginTool	2.01.00 09/21/2029	Started	Unnecessary
License Generator	4.4.0 09/21/2029	Installed	Installed

Below the table is a "Resource Information" section with a table showing resource usage:

Resource Name	Amount Used	Remaining	Percent Used
Storage	13193 KB	19575 KB	40%
Memory	3700 KB	16780 KB	18%
Threads	11	117	9%
Sockets	6	122	5%
File Descriptors	7	121	6%

The page footer includes the "meap" logo and the text "Copyright CANON INC. 2011 All Rights Reserved". The browser status bar at the bottom shows "Done" and "Trusted sites | Protected Mode: Off".

3

Select the check box for the application whose setting information you wish to delete, and then click [Delete].

Click [Select All] to select all of the applications.

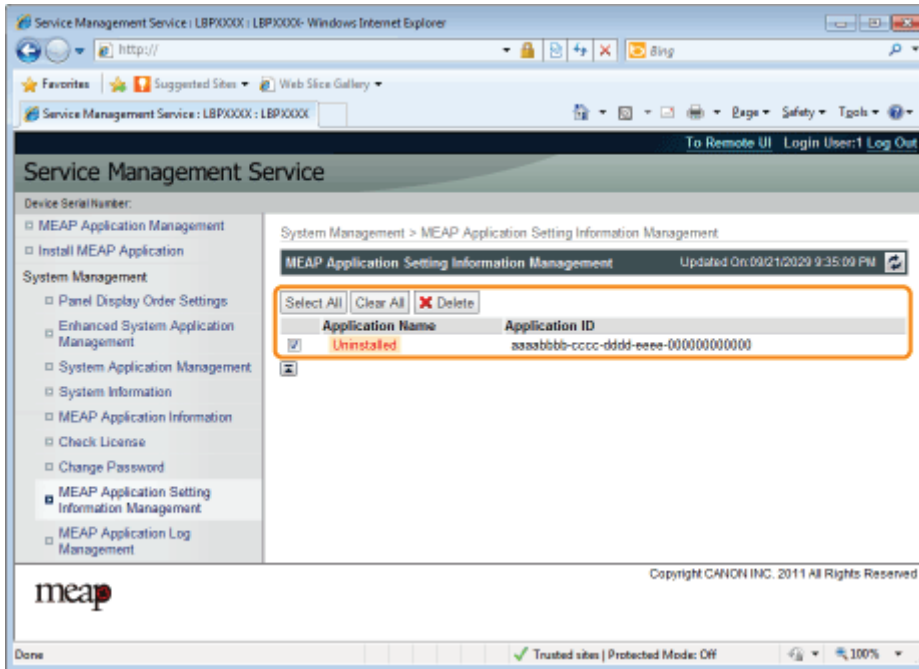

4

Click [Yes].

→ The setting information of the application is deleted.

Managing MEAP Application Log Data

04L9-0HR

It downloads and deletes log data obtained by MEAP applications.

[↳ Downloading Log Data](#)

[↳ Deleting Log Data](#)

Downloading Log Data

04L9-0HS

1

Start SMS (Service Management Service).

➤ "Launching SMS (Log in)"

2

Click [MEAP Application Log Management].

The screenshot shows a web browser window displaying the Service Management Service interface. The browser address bar shows 'http://'. The page title is 'Service Management Service'. The interface includes a navigation menu on the left with 'MEAP Application Log Management' highlighted. The main content area shows 'MEAP Application Management' with a table of installed applications and a 'Resource Information' section with a table of system resources.

Application Name	Installed on	Status	License
LoginTool	2.01.00 09/21/2029	Started	Unnecessary
License Generator	4.4.0 09/21/2029	Installed	Installed

Resource Name	Amount Used	Remaining	Percent Used
Storage	13193 KB	19575 KB	40%
Memory	3700 KB	16780 KB	18%
Threads	11	117	9%
Sockets	6	122	5%
File Descriptors	7	121	5%

3

Click [Download Application Logs].

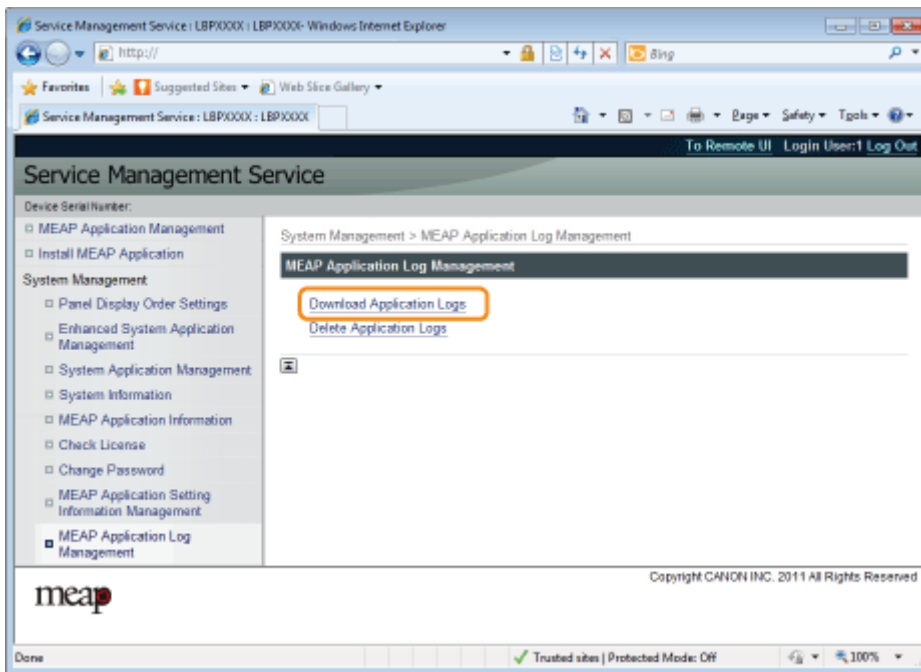

4

Follow the on-screen instructions and specify a file storage directory.

→ The log file is saved.

Deleting Log Data

04L9-0HU

1

Start SMS (Service Management Service).

➤ "Launching SMS (Log in)"

2

Click [MEAP Application Log Management].

The screenshot shows a web browser window displaying the Service Management Service interface. The browser address bar shows 'http://'. The page title is 'Service Management Service'. The interface includes a navigation menu on the left with 'MEAP Application Log Management' highlighted. The main content area shows 'MEAP Application Management' with a table of applications and a 'Resource Information' section with a table of system resources.

Application Name	Installed on	Status	License
LoginTool	2.01.00 09/21/2029	Started	Unnecessary
License Generator	4.4.0 09/21/2029	Installed	Installed

Resource Name	Amount Used	Remaining	Percent Used
Storage	13193 KB	19575 KB	40%
Memory	3700 KB	16780 KB	18%
Threads	11	117	9%
Sockets	6	122	5%
File Descriptors	7	121	5%

3

Click [Delete Application Logs].

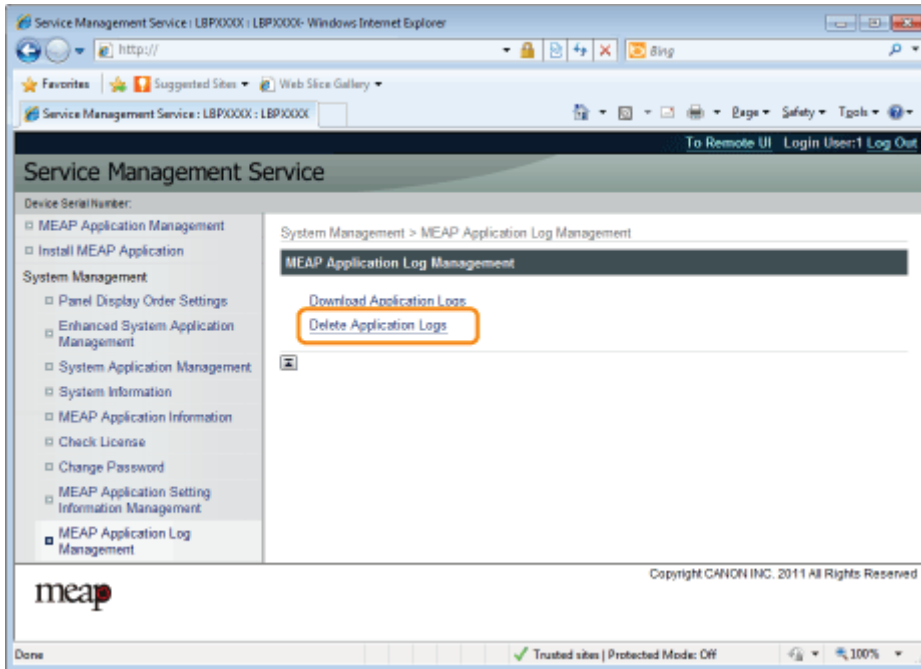

4

Click [Yes].

→ The log data is deleted.

List of Error Messages (MEAP)

04L9-0HW

This section describes how to handle error messages that are displayed when logging in to or operating SMS.

The error messages are divided into separate pages. Click the following links and perform the necessary actions.

[Errors Relating to the \[Login\] Page](#)

[Errors Relating to the \[MEAP Application Management\] Page](#)

[Errors Relating to the \[Install MEAP Application\] Page](#)

[Errors Relating to the \[Authentication Information Settings\] Page](#)

[Errors Relating to the \[License Management\] Page](#)

[Errors Relating to the \[Enhanced System Application Management\] Page](#)

[Errors Relating to the \[Check License\] and \[Change Password\] Pages](#)

[Errors Relating to the \[MEAP Application Setting Information Management\] Page](#)

[Errors Relating to the \[MEAP Application Log Management\] Page](#)

[Other Errors](#)

Errors Relating to the [Login] Page

04L9-0HX

- <The specified file does not exist or the file path is incorrect. Try to specify the path again.>
- <The contents of the specified file are incorrect or information is missing. Check the file.>
- <The specified switch license file cannot be used for password initialization. Try to specify the file again.>
- <Cannot initialize password because a used switch license file is specified. Try to specify the file again.>
- <Cannot initialize the password because another application is being installed, or the firmware being updated. Please wait a moment and then try again.>
- <You do not have permissions to use Service Management Service. Log in with administrator rights.>
- <Cannot login because another user is logged in or logout operations have not been successfully performed. Please wait a moment and then try this operation again.>
- <Error: <Error Details>>

The specified file does not exist or the file path is incorrect. Try to specify the path again.

Problem	The file does not exist on the specified path or the file path is incorrect.
Action	Specify the file path correctly.

The contents of the specified file are incorrect or information is missing. Check the file.

Problem	The specified file is not a switch license file.
Action	Check to make sure that the specified file is a switch license file for password initialization.
Problem	Information is missing from the specified file.
Action	The password cannot be initialized using the specified file. Check the content of the file.

The specified switch license file cannot be used for password initialization. Try to specify the file again.

Problem	The specified file is not a switch license file for initializing the password.
Action	Specify a switch license file for initializing the password.

Cannot initialize password because a used switch license file is specified. Try to specify the file again.

Problem	The specified license file has already been installed. License files that have been installed once cannot be installed again.
Action	Since the specified license file cannot be installed, specify another file.

Cannot initialize the password because another application is being installed, or the firmware being updated.

Please wait a moment and then try again.

Problem	Either it is installed in another application outside of SMS, or it cannot initialize the password because the firmware is being updated.
Action	Wait until the processing stops before initializing the password.

You do not have permissions to use Service Management Service. Log in with administrator rights.

Problem	Only users with administrator rights can log in to SMS with the user name and password that they use for logging in to the printer. The user trying to log in cannot do so because they do not have administrator rights.
Action	Log in again with the user name and password of a user with administrator rights.

Cannot login because another user is logged in or logout operations have not been successfully performed. Please wait a moment and then try this operation again.

Problem	Cannot log in for a period of time because either another user is logged in or when the user was logged in before, the logout procedure was not performed properly.
Action	If another user is logged in, wait until the user logs out. If another user is not logged in, wait for the lock to be cancelled.

Error: <Error Details>

Problem	An error has occurred for some reason. See <Error Details> for details.
Action	If the solutions given in <Error Details> are unclear, contact your local authorized Canon dealer or sales representatives.

Errors Relating to the [MEAP Application Management] Page

04L9-0HY

- <Cannot start this application because there is no distributable software in the application. Get a distributable software.>
- <Cannot start this application because the number of bootable applets has exceeded the limit. Start this application after stopping other applications.>
- <A license is needed to start this application. Try to start it again after installing a license.>
- <Cannot start this application because system resources (memory, threads, sockets, file descriptors, disk space, or screen size) required to start the application may not be available. <Resources>>
- <Cannot uninstall this application because the license file has not been deleted. Uninstall the application after deleting the license in the [License Management] page.>
- <The name listed in the file for the application and the applet name to register with Applet Viewer Service are different. Check the file.>
- <Error: <Error Details>>

Cannot start this application because there is no distributable software in the application. Get a distributable software.

Problem	The application cannot be started because it does not contain any redistributable modules.
Action	Contact the application developer.

Cannot start this application because the number of bootable applets has exceeded the limit. Start this application after stopping other applications.

Problem	The application that you are attempting to launch contains applets. If the application was launched, the number of applets that would be booted on the system would exceed the limit (five applets), so the application cannot be launched.
Action	First, reduce the number of applets running on the system by stopping an application running on the system which includes an applet, and then restart the application.

A license is needed to start this application. Try to start it again after installing a license.

Problem	Cannot start the application because a license file is not installed.
Action	Install the license file, and then restart the application.

Cannot start this application because system resources (memory, threads, sockets, file descriptors, disk space, or screen size) required to start the application may not be available. <Resources>

Problem	The application cannot be started because the system resources for opening the application may not be available to be allocated.
Action	Restart this application after stopping other applications. It may be able to start this time.

Cannot uninstall this application because the license file has not been deleted. Uninstall the application after deleting the license in the [License Management] page.

Problem	The application cannot be uninstalled because the license file for the application still exists inside the printer.
Action	Uninstall the application after deleting the license on the [License Management] page.

The name listed in the file for the application and the applet name to register with Applet Viewer

Service are different. Check the file.

Problem	The application cannot be started because the applet name the application is trying to register in the Applet Viewer Service differs from the applet name included in the application file.
Action	Since it is necessary to make corrections to the application file, contact the application developer.

Error: <Error Details>

Problem	An error has occurred for some reason. See <Error Details> for details.
Action	If the solutions given in <Error Details> are unclear, contact your local authorized Canon dealer or sales representatives.

Errors Relating to the [Install MEAP Application] Page

04L9-0J0

- <The file for the application to install does not exist or the file path is incorrect. Try to specify the path again.>
- <The file for the license to install does not exist or the file path is incorrect. Try to specify the path again.>
- <The manifest is not listed in the specified file. Check the file.>
- <The contents of the file for the application to install are incorrect or information is missing. Check the file.>
- <The contents of the file for the license to install are incorrect or information is missing. Check the file.>
- <The following information is missing in file for the specified application. Check the file. <Missing information>>
- <The following information in the specified application is incorrect. Check the file. <Inaccurate information>>
- <Cannot install this application because a code signing has not been confirmed to be valid. Get a valid code signing.>
- <Cannot install this license because the specified application and license do not correspond. Try to specify a path for the license file again.>
- <The number of applications that can be installed has exceeded the limit. Try to install this application after uninstalling other applications.>
- <Cannot install this license because the number of license file ID logs that can be saved has exceeded the limit. Contact your service representative.>
- <Cannot install because a used license file is specified. Try to specify the file again.>
- <To install the specified application, a license file must be installed at the same time. Specify a license file.>
- <The specified file is a system application. Install the application from the [Enhanced System Application Management] page.>
- <The specified application does not require a license.>
- <The specified license does not match this device. Specify an installable license.>
- <The specified application does not support this device.>
- <Cannot install this application because an applet included in the specified application has exceeded the area that can be displayed in the device panel.>
- <The specified file is an update file. Stop the application that you want update and then install the file.>
- <Cannot install the application because the license requirement is different. Uninstall the specified application, and then try to install the application again.>
- <Cannot install this application because storage space has been exceeded. Uninstall other applications and then try to install it again.>
- <Could not cancel installation. Installation has been successfully completed.>
- <This application does not support the MEAP version of the device. Contact your service representative after checking the application version.>
- <The specified application cannot be installed on this device.>
- <The process is canceled because the system has been shut down. Restart the system, and then perform the process again.>
- <Cannot install the application or license because another application is being installed, or the firmware being updated. Please wait a moment and then try again.>
- <Error: <Error Details>>

The file for the application to install does not exist or the file path is incorrect. Try to specify the path again.

Problem	The specified file does not exist or the file path is incorrect.
Action	Specify the file path correctly.

The file for the license to install does not exist or the file path is incorrect. Try to specify the path again.

Problem	The license file does not exist on the specified path or the file path is incorrect.
Action	Specify the file path correctly.

The manifest is not listed in the specified file. Check the file.

Problem	A manifest does not exist for the file specified as the application file.
Action	This application cannot be installed. Contact the application developer.

The contents of the file for the application to install are incorrect or information is missing. Check the file.

Problem	Either the content of the files specified as application files is not correct or information is missing.
Action	This application file cannot be installed. Check the file. If there are no problems with the files, contact the application developer or the application support help desk.

The contents of the file for the license to install are incorrect or information is missing. Check the file.

Problem	Either the content of the files specified as license files is not correct or information is missing.
Action	This license file cannot be installed. Check the file. If there are no problems with the files, contact the application developer or the application support help desk.

The following information is missing in file for the specified application. Check the file. <Missing information>

Problem	The application cannot be installed because required information is not included in the application file.
Action	Check the file. If there are no problems with the files, contact the application developer or the application support help desk concerning the <Missing Information>.

The following information in the specified application is incorrect. Check the file. <Inaccurate information>

Problem 1	<Inaccurate information> in the application file cannot be recognized as correct information.
Action	Contact the application developer or the application support help desk.
Problem 2	If the <Inaccurate information> is the MEAP Specifications, the application's MEAP specification values and the printer's MEAP specification values do not match.
Action	Contact your local authorized Canon dealer or sales representatives.

Cannot install this application because a code signing has not been confirmed to be valid. Get a valid code signing.

Problem 1	Cannot confirm that there is a valid code signature inside the application file.
Action	Perform the correct code signing operation for the application.
Problem 2	The file may have been altered.
Action	Contact the application developer.

Cannot install this license because the specified application and license do not correspond. Try to specify a path for the license file again.

Problem	The application cannot be installed because the specified license file does not correspond to the specified application.
----------------	--

Action	Specify the license file that corresponds to the application.
---------------	---

The number of applications that can be installed has exceeded the limit. Try to install this application after uninstalling other applications.

Problem	The maximum number of applications that can be installed is eight. You are attempting to install an application that will exceed that number.
Action	You can install it if you first uninstall another installed application (unless it is a system application).

Cannot install this license because the number of license file ID logs that can be saved has exceeded the limit. Contact your service representative.

Problem	The license file cannot be installed because the number of license file ID information logs contained in the license file exceeds the number that can be saved.
Action	Contact your local authorized Canon dealer or sales representatives.

Cannot install because a used license file is specified. Try to specify the file again.

Problem	License files that have been installed once cannot be installed again. The specified license file has already been installed.
Action	Since the specified license file cannot be installed, specify another file.

To install the specified application, a license file must be installed at the same time. Specify a license file.

Problem	You cannot install the application unless you specify the license file that corresponds to the application at the same time.
Action	Specify the corresponding license file when specifying the application, and then install them.

The specified file is a system application. Install the application from the [Enhanced System Application Management] page.

Problem	The specified file is a system application. It cannot be installed from this [Install MEAP Application] page.
Action	Install it from the [Enhanced System Application Management] page.

The specified application does not require a license.

Problem	An application file and license file were specified, but the specified application file does not require a license file.
Action	Install the application without specifying a license file.

The specified license does not match this device. Specify an installable license.

Problem	License files contain the serial number information of printers in which the license file can be installed. The specified license cannot be installed because it does not contain the printer's serial number information.
Action	Specify a license file that matches the printer's serial number.

The specified application does not support this device.

Problem	Some applications can only be installed in certain printer models. It cannot be installed in this model.
Action	Specify an application that supports this printer.

Cannot install this application because an applet included in the specified application has exceeded the area that can be displayed in the device panel.

Problem	The application cannot be installed because the display area of an applet included in the application exceeds the area that can be displayed on the operation panel of the printer.
Action	Install an application that contains applets that support this printer.

The specified file is an update file. Stop the application that you want update and then install the file.

Problem	The specified application file is a file for updating an application which is already installed. It is necessary to stop the application which is to be updated before updating.
Action	Stop the application that you want to update, and then perform the update again.

Cannot install the application because the license requirement is different. Uninstall the specified application, and then try to install the application again.

Problem	You have tried to upgrade an application which is already installed using a version of the same application with different license requirements.
Action	Upgrade using the same license conditions.

Cannot install this application because storage space has been exceeded. Uninstall other applications and then try to install it again.

Problem	The application cannot be installed because there is not enough free storage capacity.
Action	Make storage capacity available by uninstalling an application that is not being used.

Could not cancel installation. Installation has been successfully completed.

Problem	The [Cancel] button was pressed when the installation operation could not be cancelled.
Action	Disable the license file, download it from the [License Management] page, and then uninstall it.

This application does not support the MEAP version of the device. Contact your service representative after checking the application version.

Problem	The specified application cannot be installed because it does not support the MEAP version on this printer.
Action	Contact the application developer.

The specified application cannot be installed on this device.

Problem	The specified application cannot be installed because there is not enough memory in the printer.
Action	Contact your local authorized Canon dealer or sales representatives.

The process is canceled because the system has been shut down. Restart the system, and then perform the process again.

Problem	The installation could not be completed because it conflicted with a system shutdown.
Action	Restart the printer and perform the install again.

Cannot install the application or license because another application is being installed, or the firmware being updated. Please wait a moment and then try again.

Problem	Either it is installed in another application outside of SMS, or the application cannot be installed because the firmware has been updated.
Action	Wait until the processing stops before installing the application.

Error: <Error Details>

Problem	An error has occurred for some reason. See <Error Details> for details.
Action	If the solutions given in <Error Details> are unclear, contact your local authorized Canon dealer or sales representatives.

Errors Relating to the [Authentication Information Settings] Page

04L9-0J1

- <Settings are incorrect.>
- <The [Department ID] is incorrect. Enter an integer for the [Department ID].>
- <The [Department ID] is not entered.>
- <Could not set authentication information because an error occurred.>
- <Could not delete authentication information because an error occurred.>

Settings are incorrect.

- Check to see if the password is incorrect.
- Enter Dept. ID within 7 digits.
- Check to see if the Department. ID is registered with the device.

Problem	Cannot set authentication information because either the Dept. ID entered does not exist, or the PIN was entered incorrectly.
Action	Enter a Dept. ID and PIN that are registered in the printer.

The [Department ID] is incorrect. Enter an integer for the [Department ID].

Problem	The Dept. ID that was entered is a positive integer, but the registered Dept. ID is not a positive integer.
Action	Enter the correct Dept. ID that is registered in the device.

The [Department ID] is not entered.

Problem	The Dept. ID is blank.
Action	Specify a Dept. ID.

Could not set authentication information because an error occurred.

Problem	An error has occurred for some reason, so authentication information could not be set.
Action	Contact your local authorized Canon dealer or sales representatives.

Could not delete authentication information because an error occurred.

Problem	An error has occurred for some reason, so authentication information could not be deleted.
Action	Contact your local authorized Canon dealer or sales representatives.

Errors Relating to the [License Management] Page

04L9-0J2

- <The specified file does not exist or the file path is incorrect. Try to specify the path again.>
- <The contents of the file for the license to install are incorrect or information is missing. Check the file.>
- <Cannot install this license because the specified license does not correspond to this application. Try to specify a path for the license file again.>
- <Cannot install this license because the number of license file ID logs that can be saved has exceeded the limit. Contact your service representative.>
- <Cannot install because a used license file is specified. Try to specify the file again.>
- <The specified license does not match this device. Specify an installable license.>
- <Could not cancel installation. Installation has been successfully completed.>
- <Cannot install the license because another application is being installed, or the firmware being updated. Please wait a moment and then try again.>
- <Cannot disable the license file because this application has been started. Disable the license file after stopping the application.>
- <Error: <Error Details>>

The specified file does not exist or the file path is incorrect. Try to specify the path again.

Problem	The file does not exist on the specified path or the file path is incorrect.
Action	Specify the file path correctly.

The contents of the file for the license to install are incorrect or information is missing. Check the file.

Problem	Either the content of the file is not correct or information is missing.
Action	This license file cannot be installed. Contact the application developer.

Cannot install this license because the specified license does not correspond to this application. Try to specify a path for the license file again.

Problem	The specified license file does not correspond to the application, so they cannot be installed.
Action	Specify the license file that corresponds to the application. Check to make sure that the manifest file listed inside the license file is correct.

Cannot install this license because the number of license file ID logs that can be saved has exceeded the limit. Contact your service representative.

Problem	The license file cannot be installed because the number of license file ID information logs contained in the license file exceeds the number that can be saved.
Action	Contact your local authorized Canon dealer or sales representatives.

Cannot install because a used license file is specified. Try to specify the file again.

Problem	According to the specifications, a license file which is already installed cannot be installed again. The specified license file has already been installed.
Action	Since the specified license file cannot be installed, specify another file.

The specified license does not match this device. Specify an installable license.

Problem	License files contain lists of printers in which they can be installed. The specified license file cannot be
----------------	--

	installed in this printer.
Action	Specify a license file that can be installed in this printer.

Could not cancel installation. Installation has been successfully completed.

Problem	The [Cancel] button was pressed when the installation operation could not be cancelled.
Action	Disable the license file, download it from the [License Management] page, and then uninstall it.

**Cannot install the license because another application is being installed, or the firmware being updated.
Please wait a moment and then try again.**

Problem	Either it is installed in another application outside of SMS, or the license file cannot be installed because the firmware has been updated.
Action	Wait until the processing stops before installing the license file.

Cannot disable the license file because this application has been started. Disable the license file after stopping the application.

Problem	You cannot disable a license if the corresponding application is still running.
Action	Stop the application that corresponds to the license before disabling the license.

Error: <Error Details>

Problem	An error has occurred for some reason. See <Error Details> for details.
Action	If the solutions given in <Error Details> are unclear, contact the application developer.

- <Cannot start this application because there is no distributable software in the application. Get a distributable software.>
- <Cannot start this application because the number of bootable applets has exceeded the limit. Start this application after stopping other applications.>
- <Cannot start this application because system resources (memory, threads, sockets, file descriptors, disk space, or screen size) required to start the application may not be available. <Resources>>
- <The name listed in the file for the application and the applet name to register with Applet Viewer Service are different. Check the file.>
- <The following login services cannot be uninstalled:
 - The currently set login service
 - Login services that will be enabled after the device is restarted
 - Default Authentication login services
 The currently set login service can be uninstalled after the device is restarted.>
- <The file for the application to install does not exist or the file path is incorrect. Try to specify the path again.>
- <The manifest is not listed in the specified file. Check the file.>
- <The file for the license to install does not exist or the file path is incorrect. Try to specify the path again.>
- <The contents of the file for the application to install are incorrect or information is missing. Check the file.>
- <The contents of the file for the license to install are incorrect or information is missing. Check the file.>
- <Cannot install this application because a code signing has not been confirmed to be valid. Get a valid code signing.>
- <Cannot install this license because the specified application and license do not correspond. Try to specify a path for the license file again.>
- <The specified file is not system application. Check the file.>
- <Cannot install this license because the number of license file ID logs that can be saved has exceeded the limit. Contact your service representative.>
- <Cannot install because a used license file is specified. Try to specify the file again.>
- <To install the specified application, a license file must be installed at the same time. Specify a license file.>
- <The following information in the specified application is incorrect. Check the file. <Inaccurate information>>
- <The following information is missing in file for the specified application. Check the file. <Missing information>>
- <The specified application does not support this device.>
- <The specified license does not match this device. Specify an installable license.>
- <Cannot install this application because an applet included in the specified application has exceeded the area that can be displayed in the device panel.>
- <The specified file is an update file. Stop the application that you want update and then install the file.>
- <The specified file is an update file for a login service that is currently set. Switch to another login service, restart the device, and then install the file.>
- <Cannot install this application because storage space has been exceeded. Uninstall other applications and then try to install it again.>
- <Could not cancel installation. Installation has been successfully completed.>
- <The process is canceled because the system has been shut down. Restart the system, and then perform the process again.>
- <Cannot install the application or license because another application is being installed, or the firmware being updated. Please wait a moment and then try again.>
- <Error: <Error Details>>

Cannot start this application because there is no distributable software in the application. Get a distributable software.

Problem	The application cannot be started because it does not contain any redistributable modules.
Action	Contact the application developer.

Cannot start this application because the number of bootable applets has exceeded the limit. Start this application after stopping other applications.

Problem	The application that you are attempting to launch contains applets. If the application was launched, the number of applets that would be booted on the system would exceed the limit (five applets), so the application cannot be launched.
----------------	---

Action	First, reduce the number of applets running on the system by stopping an application running on the system which includes an applet, and then restart the application.
---------------	--

Cannot start this application because system resources (memory, threads, sockets, file descriptors, disk space, or screen size) required to start the application may not be available. <Resources>

Problem	The application cannot be started because the system resources for opening the application may not be available to be allocated.
Action	Restart this application after stopping other applications. It may be able to start this time.

The name listed in the file for the application and the applet name to register with Applet Viewer Service are different. Check the file.

Problem	The application cannot be started because the applet name the application is trying to register in the Applet Viewer Service differs from the applet name included in the application file.
Action	Since it is necessary to make corrections to the application file, contact the application developer.

The following login services cannot be uninstalled:

- The currently set login service
- Login services that will be enabled after the device is restarted
- Default Authentication login services

The currently set login service can be uninstalled after the device is restarted.

Problem	The currently set login service, a login service that will be enabled after restarting the machine, and the Default Authentication login service cannot be uninstalled.
Action	Do not uninstall the currently set login service, a login service that will be enabled after restarting the machine, or the Default Authentication login service. To uninstall the currently set login service, uninstall it after restarting the machine.

The file for the application to install does not exist or the file path is incorrect. Try to specify the path again.

Problem	The specified file does not exist or the file path is incorrect.
Action	Specify the file path correctly.

The manifest is not listed in the specified file. Check the file.

Problem	A manifest does not exist for the file specified as the application file.
Action	This application cannot be installed. Contact the application developer.

The file for the license to install does not exist or the file path is incorrect. Try to specify the path again.

Problem	The specified file does not exist or the file path is incorrect.
Action	Specify the file path correctly.

The contents of the file for the application to install are incorrect or information is missing. Check the file.

Problem	Either the content of the files specified as application files is not correct or information is missing.
----------------	--

Action	This application file cannot be installed. Check the file. If there are no problems with the files, contact the application developer or the application support help desk.
---------------	---

The contents of the file for the license to install are incorrect or information is missing. Check the file.

Problem	Either the content of the files specified as license files is not correct or information is missing.
Action	This license file cannot be installed. Check the file. If there are no problems with the files, contact the application developer or the application support help desk.

Cannot install this application because a code signing has not been confirmed to be valid. Get a valid code signing.

Problem 1	Cannot confirm that there is a valid code signature inside the application file.
Action	Perform the correct code signing operation for the application.
Problem 2	The file may have been altered.
Action	Contact the application developer.

Cannot install this license because the specified application and license do not correspond. Try to specify a path for the license file again.

Problem	The application cannot be installed because the specified license file does not correspond to the specified application.
Action	Specify the license file that corresponds to the application.

The specified file is not system application. Check the file.

Problem	The specified file is not system application. It cannot be installed from the [Enhanced System Application Management] page.
Action	Install it from the [Install MEAP Application] page.

Cannot install this license because the number of license file ID logs that can be saved has exceeded the limit. Contact your service representative.

Problem	The license file cannot be installed because the number of license file ID information logs contained in the license file exceeds the number that can be saved.
Action	Contact your local authorized Canon dealer or sales representatives.

Cannot install because a used license file is specified. Try to specify the file again.

Problem	License files that have been installed once cannot be installed again. The specified license file has already been installed.
Action	Since the specified license file cannot be installed, specify another file.

To install the specified application, a license file must be installed at the same time. Specify a license file.

Problem	You cannot install the application unless you specify the license file that corresponds to the application at the same time.
----------------	--

Action	Specify the corresponding license file when specifying the application, and then install them.
---------------	--

The following information in the specified application is incorrect. Check the file. <Inaccurate information>

Problem 1	<Inaccurate information> in the application file cannot be recognized as correct information.
Action	Contact the application developer or the application support help desk.
Problem 2	If the <Inaccurate information> is the MEAP Specifications, the application's MEAP specification values and the printer's MEAP specification values do not match.
Action	Contact your local authorized Canon dealer or sales representatives.

The following information is missing in file for the specified application. Check the file. <Missing information>

Problem	The application cannot be installed because required information is not included in the application.
Action	Check the file. If there are no problems with the files, contact the application developer or the application support help desk concerning the <Missing Information>.

The specified application does not support this device.

Problem	Some applications can only be installed in certain printer models. It cannot be installed in this model.
Action	Specify an application that supports this printer.

The specified license does not match this device. Specify an installable license.

Problem	License files contain the serial number information of printers in which the license file can be installed. The specified license cannot be installed because it does not contain the printer's serial number information.
Action	Specify a license file that matches the serial number of this printer.

Cannot install this application because an applet included in the specified application has exceeded the area that can be displayed in the device panel.

Problem	The application cannot be installed because the display area of an applet included in the application exceeds the area that can be displayed on the operation panel of the printer.
Action	Install an application that contains applets that support this printer.

The specified file is an update file. Stop the application that you want update and then install the file.

Problem	The specified application file is a file for updating an application which is already installed. It is necessary to stop the application which is to be updated before updating.
Action	Stop the application that you want to update, and then perform the update again.

The specified file is an update file for a login service that is currently set. Switch to another login service, restart the device, and then install the file.

Problem	Although the specified application file is an update file for the login service that is currently set, it cannot update a login service that has already started.
----------------	---

Action	To install the update file for the login service, start another login service, and then install the update file.
---------------	--

Cannot install this application because storage space has been exceeded. Uninstall other applications and then try to install it again.

Problem	The application cannot be installed because there is not enough free storage capacity.
----------------	--

Action	Make storage capacity available by uninstalling an application that is not being used.
---------------	--

Could not cancel installation. Installation has been successfully completed.

Problem	The [Cancel] button was pressed when the installation operation could not be cancelled.
----------------	---

Action	Disable the license file, download it from the [License Management] page, and then uninstall it.
---------------	--

The process is canceled because the system has been shut down. Restart the system, and then perform the process again.

Problem	The installation could not be completed because it conflicted with a system shutdown.
----------------	---

Action	Restart the printer and perform the install again.
---------------	--

Cannot install the application or license because another application is being installed, or the firmware being updated. Please wait a moment and then try again.

Problem	Either it is installed in another application outside of SMS, or the application cannot be installed because the firmware has been updated.
----------------	---

Action	Wait until the processing stops before installing the application.
---------------	--

Error: <Error Details>

Problem	An error has occurred for some reason. See <Error Details> for details.
----------------	---

Action	If the solutions given in <Error Details> are unclear, contact your local authorized Canon dealer or sales representatives.
---------------	---

Errors Relating to the [Check License] and [Change Password] Pages

04L9-0J4

- <The specified file does not exist or the file path is incorrect. Try to specify the path again.>
- <The contents of the specified file are incorrect or information is missing. Check the file.>
- <The specified switch license file cannot be used to delete the license file ID log. Try to specify the path again.>
- <The specified license is already installed. Installed license file information cannot be displayed.>
- <Cannot perform the operation because another application is being installed, or the firmware being updated. Please wait a moment and then try again.>
- <The old password is incorrect.>
- <The new password is incorrect. Enter the password with 8 to 32 single-byte alphanumeric characters.>
- <The new password and password to confirm do not match.>
- <Error: <Error Details>>

The specified file does not exist or the file path is incorrect. Try to specify the path again.

Problem	The file does not exist on the specified path or the file path is incorrect.
Action	Specify the file path correctly.

The contents of the specified file are incorrect or information is missing. Check the file.

Problem 1	The content of the file is not correct. (A file other than a license file was specified.)
Action	Check to make sure that the specified file is a license file.
Problem 2	Information is missing from the file.
Action	Check the content of the file.

The specified switch license file cannot be used to delete the license file ID log. Try to specify the path again.

Problem	The specified file is not a switch license file for deleting license file ID logs.
Action	Try specifying the file path for the switch license for deleting license file ID logs.

The specified license is already installed. Installed license file information cannot be displayed.

Problem	Information about license files that have already been installed in this printer cannot be displayed.
Action	Specify another license file.

Cannot perform the operation because another application is being installed, or the firmware being updated.

Please wait a moment and then try again.

Problem	Either it is installed in another application outside of SMS, or the license file information cannot be displayed because the firmware has been updated.
Action	Wait until the processing stops before displaying the license information.

The old password is incorrect.

Problem	The text string entered as the current password is different from the current password.
Action	Enter the correct password.

The new password is incorrect. Enter the password with 8 to 32 single-byte alphanumeric characters.

Problem	The new password has under 8 characters or more than 33 characters. Illegal characters that cannot be used in passwords have been used.
Action	Enter a new password of between 8 and 32 alphanumeric characters (a to z, A to Z, and 0 to 9).

The new password and password to confirm do not match.

Problem	The password cannot be changed because the new password and the confirmation password do not match.
Action	Enter a new password and the same text string as the confirmation password.

Error: <Error Details>

Problem	An error has occurred for some reason. See <Error Details> for details.
Action	If the solutions given in <Error Details> are unclear, contact your local authorized Canon dealer or sales representatives.

Errors Relating to the [MEAP Application Setting Information Management] Page

04L9-0J5

- <Could not delete MEAP application setting information because an error occurred.>

Could not delete MEAP application setting information because an error occurred.

Problem	An error has occurred for some reason, so the setting information could not be deleted.
Action	Return to the previous page using the [Back] button.

Errors Relating to the [MEAP Application Log Management] Page

04L9-0J6

- <Cannot download application logs because application logs do not exist.>
- <Could not download application logs because an error occurred.>
- <Could not delete application logs because an error occurred.>

Cannot download application logs because application logs do not exist.

Problem	The application log does not exist.
Action	Return to the previous page using the [Back] button.

Could not download application logs because an error occurred.

Problem	An error has occurred for some reason, so the log could not be downloaded.
Action	Return to the previous page using the [Back] button.

Could not delete application logs because an error occurred.

Problem	An error has occurred for some reason, so the log could not be deleted.
Action	Return to the previous page using the [Back] button.

Other Errors

04L9-0J7

- <Cannot find the specified application. It may have been uninstalled by another user.>

Cannot find the specified application. It may have been uninstalled by another user.

Problem	The application for the attempted operation does not exist.
Action	Return to the previous page using the [Back] button.



Printer Unit Problems

- ❖ Printing Cannot Be Performed
- ❖ The Printer Takes a Long Time to Start the Print Job
- ❖ You Cannot Turn the Printer ON
- ❖ All the Indicators on the Network Interface Are Off



Driver Problems

- ❖ You Cannot Install the Printer Driver
- ❖ You Cannot Uninstall the Printer Driver
- ❖ The Printer Driver Settings Cannot Be Changed
- ❖ "Profiles" Cannot Be Selected or Edited
- ❖ The Status of the Paper Feeder Cannot Be Obtained Automatically



Paper Jams

- ❖ Paper Jams



Error Display

- ❖ The Message Indicator Is On
- ❖ A Message Appears in the Control Panel



Printout Problems

- ❖ Poor Printout Results



Other Problems



If You Cannot Solve a Problem

Printing Cannot Be Performed

04L9-0J9

The solutions for when printing cannot be performed vary depending on your environment. See the solutions according to your environment.

If You Are Using the Printer by Direct Connection

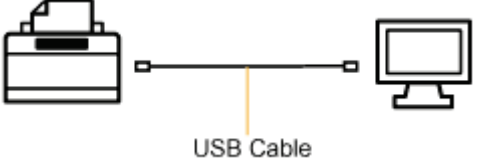
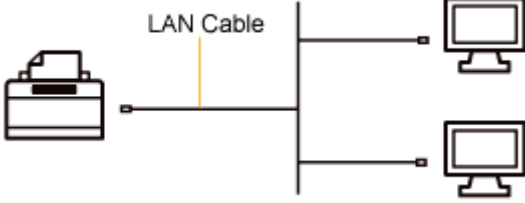
<p>If the printer is connected by a USB cable</p> 	<ul style="list-style-type: none"> ❖ "Printing Cannot Be Performed (USB Connection)"
<p>If the printer is connected by a LAN cable</p> 	<ul style="list-style-type: none"> ❖ "Printing Cannot Be Performed (LAN Connection)"

If You Are Using the Printer in the Print Server Environment

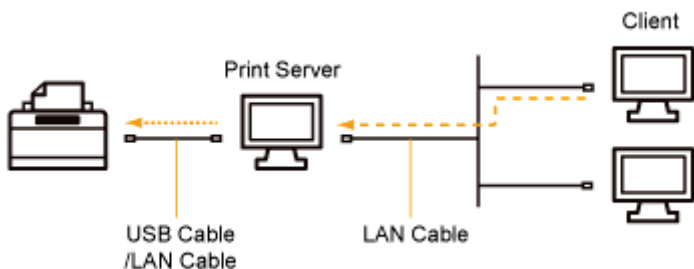

<p>If your computer is the print server</p>	<ul style="list-style-type: none"> ❖ "Printing Cannot Be Performed (USB Connection)" ❖ "Printing Cannot Be Performed (LAN Connection)"
<p>If your computer is a client computer</p>	<ul style="list-style-type: none"> ❖ "Printing Cannot Be Performed (via the Print Server)"

Printing Cannot Be Performed (USB Connection)

04L9-0JA

If you cannot print when the printer is connected to the computer by a USB cable, check the problem following the questions below.

NOTE

For Macintosh users

This section describes the procedure for Windows as an example.

For details on the procedure for Macintosh, see "Driver Guide."

For details on the procedure for displaying "Driver Guide", see "[Viewing the Driver Guide](#)."

<Question 1> Is the printer turned ON?

Check if the Main Power indicator on the control panel is turned on.

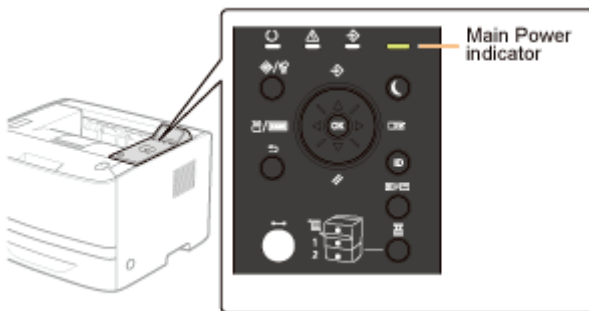

ON	To <Question 2>
OFF	Turn the printer ON.
Cannot be turned ON	➤ " You Cannot Turn the Printer ON "

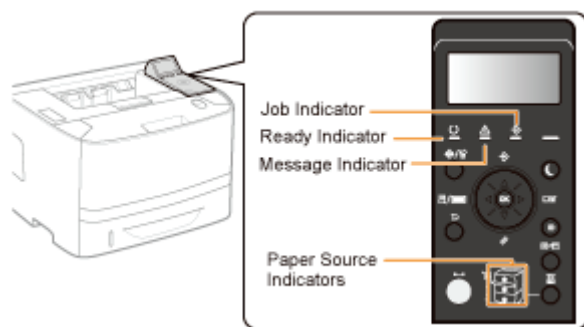

<Question 2> Check the indicators on the printer unit.



The ○ (Ready) indicator is on.	To <Question 3>
The ○ (Ready) indicator is blinking.	The printer is warming up. Please wait a moment.
The ▲ (Message) indicator is on.	➤ " The Message Indicator Is On "
The ⇨ (Job) indicator is on.	The printer is operating. Please wait a moment.
The ⇨ (Job) indicator is blinking.	If the printer does not perform printing for a while, perform the print data output or soft reset. ➤ " Canceling a Job "
The Paper Source indicator is blinking.	It is out of paper. Load paper. ➤ " Paper Loading and Output "

<Question 3> Check the  (Online) indicator.



The  (Online) indicator is on.	To <Question 4>
The  (Online) indicator is off.	The printer is offline. Place it online. ❖ "Online and Offline"

<Question 4> Can you print Configuration Page?

❖ "Checking the Printer Settings"

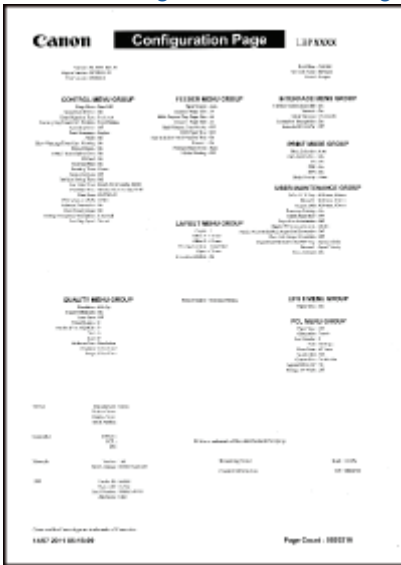

Printable	To <Question 5>
Not printable	If an error message is displayed, solve the problem following the message. ❖ "A Message Appears in the Control Panel"

<Question 5> Is the USB cable connected properly?

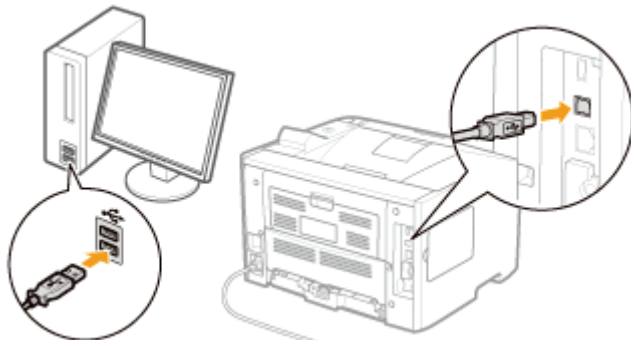

Connected	<p>Try the following points.</p> <ul style="list-style-type: none"> • If you are using a hub, connect the printer to the computer directly. • If you are using a long USB cable, replace it with the short one. • If you have another USB cable, use it. <p style="text-align: center;">▼</p> <p style="text-align: center;">If printing does not work, proceed to <Question 6>.</p>
------------------	---

Unconnected	Connect the cable properly. ❖ "Connecting to a Computer"
--------------------	---

<Question 6> Check the settings for [Interface Selection].

❖ "[Setup] Menu ([Interface] Options)"

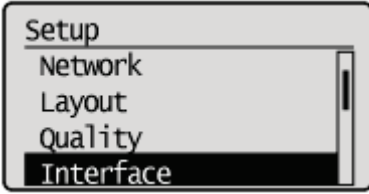

[USB] is set to [On].	To <Question 7>
[USB] is set to [Off].	Set it to [On].

<Question 7> Can you print a test page in Windows?

❖ "Basic Operations/Various Information for Windows"



Printable	There is no problem with the printer and driver. Check the printing preferences in the application.
Not printable	To <Question 8>

<Question 8> Is the port to be used selected correctly?

❖ "Basic Operations/Various Information for Windows"

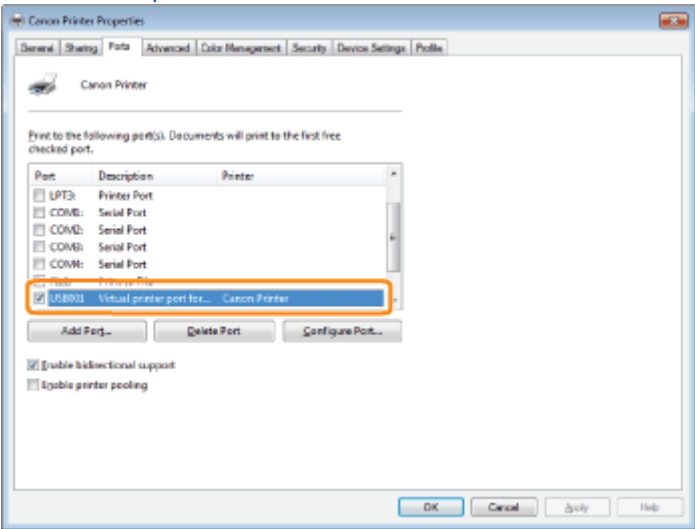

Selected	To <Question 9>
Not selected	Select the correct port.

The port to be used cannot be found.

Install the printer driver again.

For details on the procedure for installing and uninstalling the printer driver, see "Printer Driver Installation Guide."

For details on the procedure for viewing "Printer Driver Installation Guide", see "[Installation](#)."

<Question 9> Is bi-directional communication enabled?

❖ "Basic Operations/Various Information for Windows"

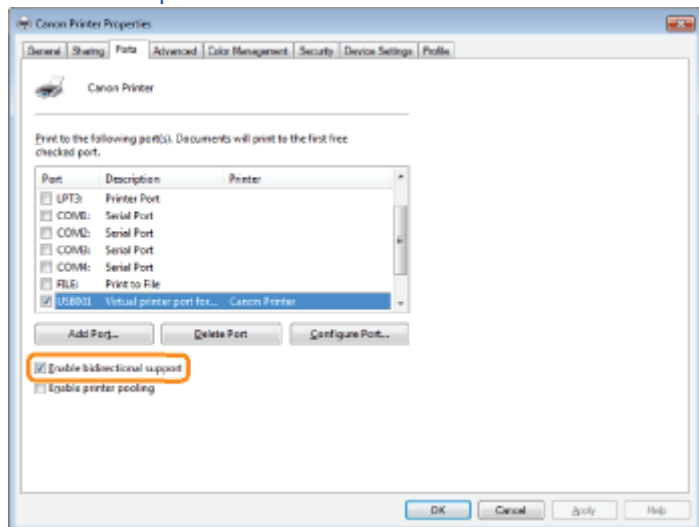

Enabled	To <Question 10>
Not enabled	Enable bi-directional communication and restart the computer and printer.

<Question 10> Try the following points.

- Make resident software invalid including security software.
- If any other devices are connected to your computer by USB connection, disconnect those unneeded.
- If drivers or software of any other devices (USB connection) is installed on your computer, uninstall those unneeded.
- Connect the USB cable to another USB port on your computer.
- Connect the printer to another computer with a USB cable.



If printing does not work, proceed to <Question 11>.

<Question 11> Install the printer driver again.

For details on the procedure for installing the printer driver, see "Printer Driver Installation Guide."

For details on the procedure for viewing "Printer Driver Installation Guide", see "[Installation](#)."



If printing does not work, proceed to <Question 12>.

<Question 12> Uninstall the USB class driver, and then install the printer driver again.

For details on the procedure for uninstalling the USB class driver and installing the printer driver, see "Printer Driver Installation Guide" on the User Software CD-ROM.

For details on the procedure for viewing "Printer Driver Installation Guide", see "[Installation](#)."



If printing does not work, contact your local authorized Canon dealer.

Printing Cannot Be Performed (LAN Connection)

04L9-0JC

If you cannot print when the printer is connected to the computer by a LAN cable, check the problem following the questions below.

NOTE

For Macintosh users

This section describes the procedure for Windows as an example.

For details on the procedure for Macintosh, see "Driver Guide."

For details on the procedure for displaying "Driver Guide", see "[Viewing the Driver Guide](#)."

<Question 1> Is the printer turned ON?

Check if the Main Power indicator on the control panel is turned on.

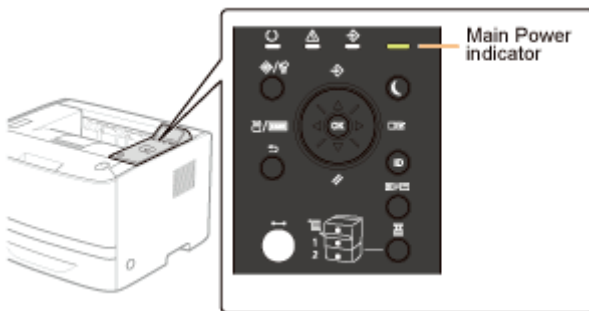

ON	To <Question 2>
OFF	Turn the printer ON.
Cannot be turned ON	➤ " You Cannot Turn the Printer ON "

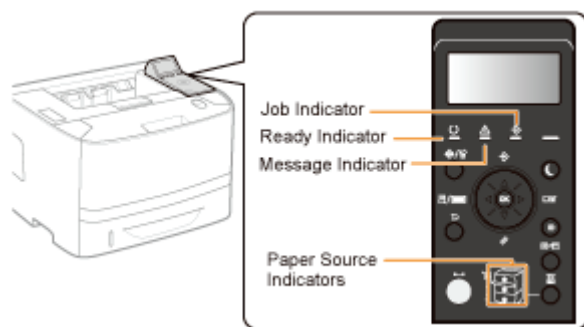

<Question 2> Check the indicators on the printer unit.



The ○ (Ready) indicator is on.	To <Question 3>
The ○ (Ready) indicator is blinking.	The printer is warming up. Please wait a moment.
The ▲ (Message) indicator is on.	➤ " The Message Indicator Is On "
The ⇨ (Job) indicator is on.	The printer is operating. Please wait a moment.
The ⇨ (Job) indicator is blinking.	If the printer does not perform printing for a while, perform the print data output or soft reset. ➤ " Canceling a Job "
The Paper Source indicator is blinking.	Load paper. ➤ " Paper Loading and Output "

<Question 3> Check the  (Online) indicator.



The  (Online) indicator is on.	To <Question 4>
The  (Online) indicator is off.	The printer is offline. Place it online. ❖ "Online and Offline"

<Question 4> Can you print NETWORK STATUS PRINT?

❖ "Checking the Printer Settings"

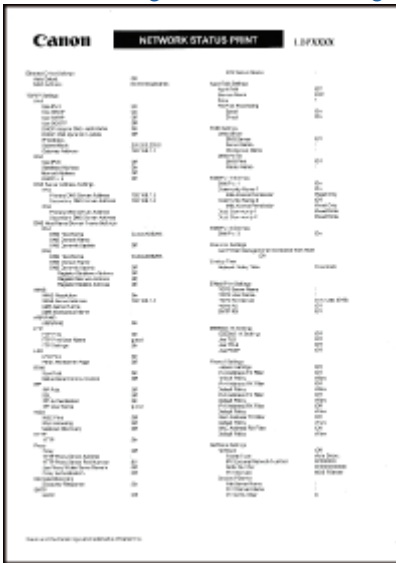

Printable	To <Question 5>
Not printable	If an error message is displayed, solve the problem following the message. ❖ "A Message Appears in the Control Panel"

<Question 5> Is the LAN cable connected properly?

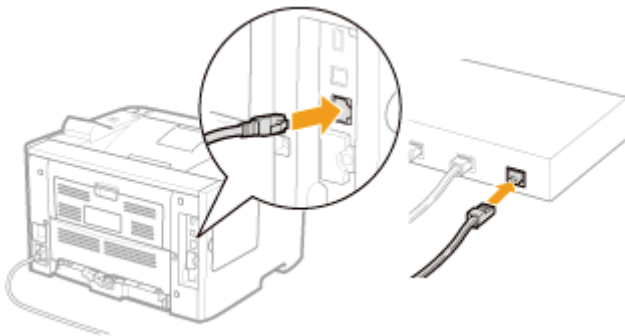

Connected	To <Question 6>
Unconnected	Connect the cable properly. ❖ "Connecting to a Computer"

<Question 6> Check the indicators on the network interface.

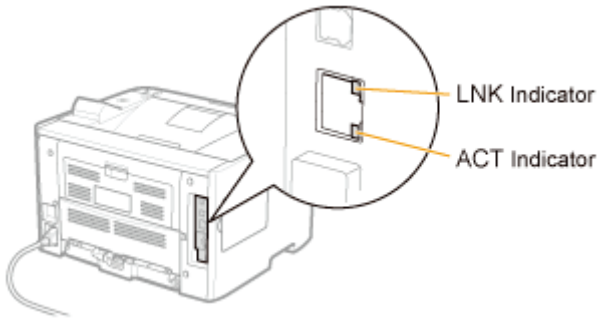

The ACT indicator is on.	To <Question 7>
The LNK indicator is on.	
All the indicators are off.	❖ "All the Indicators on the Network Interface Are Off"

<Question 7> Check the settings for [Interface Selection].

❖ "[Setup] Menu ([Interface] Options)"

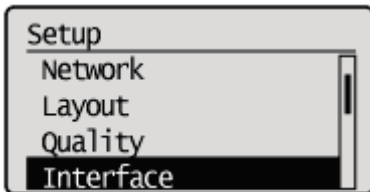

[Network] is set to [On].	To <Question 8>
[Network] is set to [Off].	Set it to [On].

<Question 8> Can you print a test page in Windows?

❖ "Basic Operations/Various Information for Windows"



Printable	There is no problem with the printer and driver. Check the printing preferences in the application.
Not printable	To <Question 9>

<Question 9> Which network protocol are you using?

TCP/IP	To <Question 10>
NetWare or SMB	To <Question 14>
AppleTalk	To <Question 17>

<Question 10> Is the IP address set properly?

Check if the IP address written on Network Status Print printed in <Question 4> matches the one configured for the port of your PC.

- ❖ "Checking the Printer Settings"
- ❖ "Checking the Port"

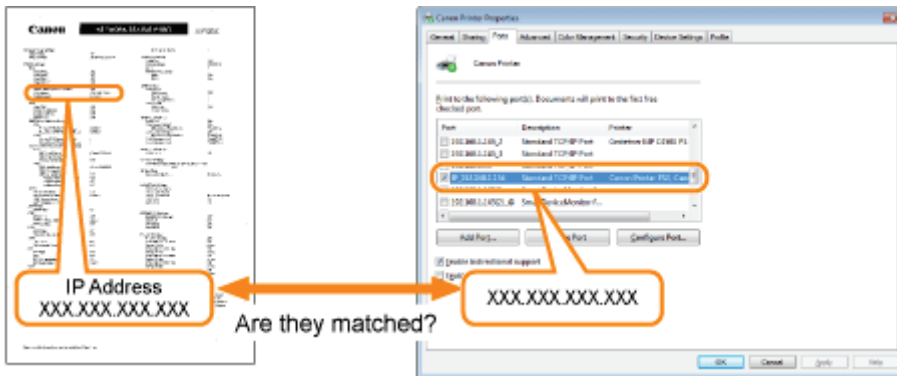

Yes, they are matched.	To <Question 11>
No, they are not matched.	Configure the printer to a static IP address. ❖ "Setting the Printer to a Static IP Address"

<Question 11> Is the port to be used selected correctly?

- ❖ "Basic Operations/Various Information for Windows"

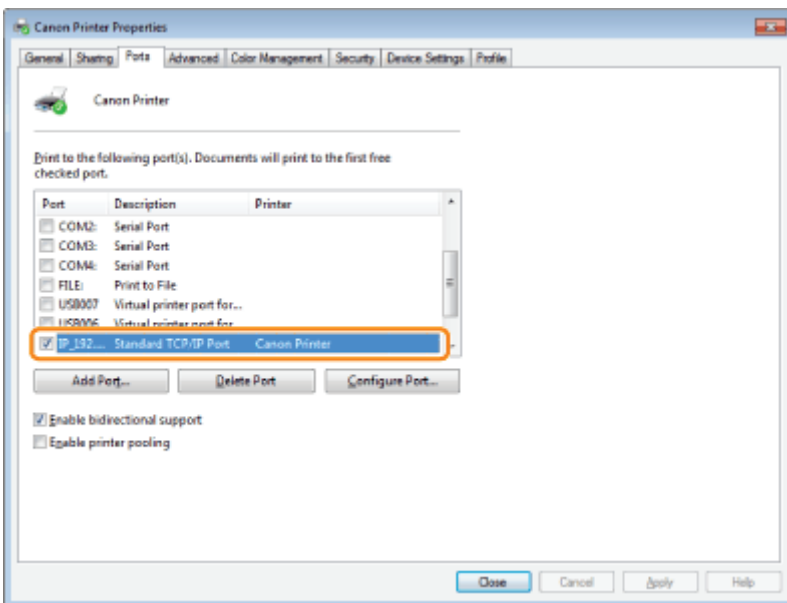

Selected	To <Question 12>
Not selected	Select the correct port.
The port to be used cannot be found.	Create a port.
The IP address was changed.	❖ "Connecting the Printer (LPD/RAW)"

<Question 12> Check the following points.

- The printer is specified as the default printer.
- The TCP/IP protocol is running.
- The users who can print are not restricted.
 - ❖ "Restricting the Users Who Can Print or Perform the Printer Settings"
 - ❖ "Restricting the Users Who Can Access"

▼
If printing does not work, proceed to <Question 13>.

<Question 13> Try the following points.

- Change the printing protocol to LPR.
 - ❖ "Basic Operations/Various Information for Windows"
- Enable the LPR byte count.
 - ❖ "Basic Operations/Various Information for Windows"
- Shorten the name of the file to be printed.

▼
If printing does not work, proceed to <Question 19>.

<Question 14> Is NetWare or SMB set properly?

- When using NetWare
 - ❖ "Configuring NetWare"
 - ❖ "Configuring the Protocol Settings"
- When using SMB
 - ❖ "Configuring the Protocol Settings"

If you are using the DHCP server and WINS server, check if the servers are linked properly.

NetWare or SMB is set properly.	Try the following point. <ul style="list-style-type: none">• Set [Network Delay Time] longer than usual.<ul style="list-style-type: none">❖ "Specifying the Setting for Startup Waiting Time" <p style="text-align: center;">▼</p> If printing does not work, proceed to <Question 15>.
NetWare or SMB is not set properly.	Set NetWare or SMB properly.

<Question 15> Is the IP address set properly?

- ❖ "Basic Operations/Various Information for Windows"

SMB printing does not support IP v. 6.

The IP address is set properly.	To <Question 16>.
The IP address is not set properly.	Set the IP address properly. <ul style="list-style-type: none">❖ "Setting the IP Address (IP v. 4)"

<Question 16> Is the port to be used selected correctly?

- ❖ "Basic Operations/Various Information for Windows"

The port is selected correctly.	To <Question 19>.
The port is not selected properly. Or The settings for NetWare or SMB are changed.	Create the appropriate port. <ul style="list-style-type: none">• When using NetWare<ul style="list-style-type: none">❖ "Network Settings for the Printer (NetWare) (LBP6680x Only)"• When using SMB<ul style="list-style-type: none">❖ "Network Settings for the Printer (SMB) (LBP6680x Only)"

<Question 17> Is AppleTalk set properly?

- ❖ "Configuring the Protocol Settings"

In particular, make sure that the zone in which the printer exists is configured properly in [Zone].

Set	To <Question 18>
Not set	Set AppleTalk properly.

<Question 18> Check the following points.

- The printer destination is set properly.
- AppleTalk is available.

For details on the procedure for setting the printer destination, see "Driver Guide."

For details on the procedure for displaying "Driver Guide", see "[Viewing the Driver Guide.](#)"

Set	To <Question 19>
Not set	Set them properly.

<Question 19> Connect the printer and computer directly with the cross-type* LAN cable.

* This is a LAN cable which is used to connect a printer and computer directly without a hub (LAN network).



If printing does not work or if you cannot prepare a cross-type LAN cable, proceed to <Question 20>.

<Question 20> Install the printer driver again.

For details on the procedure for installing the printer driver, see "Printer Driver Installation Guide."

For details on the procedure for viewing "Printer Driver Installation Guide", see "[Installation.](#)"



If printing does not work, proceed to <Question 21>.

<Question 21> Can you print from another computer (LAN connection)?



Printable	Make resident software invalid including security software.
Not printable	Contact your local authorized Canon dealer.

Printing Cannot Be Performed (via the Print Server)

04L9-0JE

If you cannot print when the printer is used via the print server, check the problem following the questions below.

NOTE

For Macintosh users

This section describes the procedure for Windows as an example.

For details on the procedure for Macintosh, see "Driver Guide."

For details on the procedure for displaying "Driver Guide", see "[Viewing the Driver Guide](#)."

<Question 1> Is the printer turned ON?

Check if the Main Power indicator on the control panel is turned on.

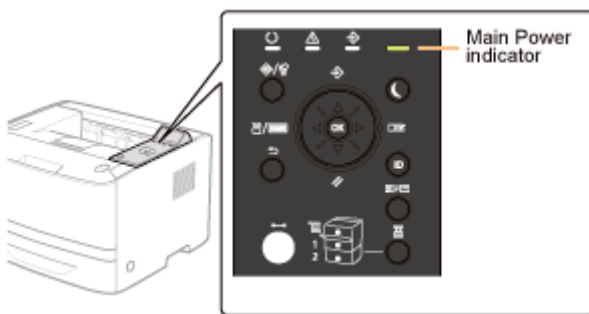

ON	To <Question 2>
OFF	Turn the printer ON.
Cannot be turned ON	➤ " You Cannot Turn the Printer ON "

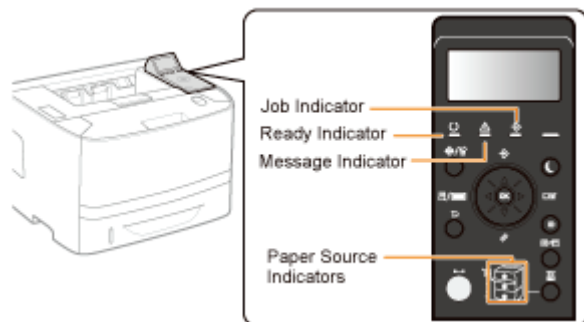

<Question 2> Check the indicators on the printer unit.



The ○ (Ready) indicator is on.	To <Question 3>
The ○ (Ready) indicator is blinking.	The printer is warming up. Please wait a moment.
The ▲ (Message) indicator is on.	➤ " The Message Indicator Is On "
The ◆ (Job) indicator is on.	The printer is operating. Please wait a moment.
The ◆ (Job) indicator is blinking.	If the printer does not perform printing for a while, perform the print data output or soft reset. ➤ " Canceling a Job "
The Paper Source indicator is blinking.	Load paper. ➤ " Paper Loading and Output "

<Question 3> Check the  (Online) indicator.



The  (Online) indicator is on.	To <Question 4>
The  (Online) indicator is off.	The printer is offline. Place it online. ❖ "Online and Offline"

<Question 4> Can you print Configuration Page?

[❖ "Checking the Printer Settings"](#)

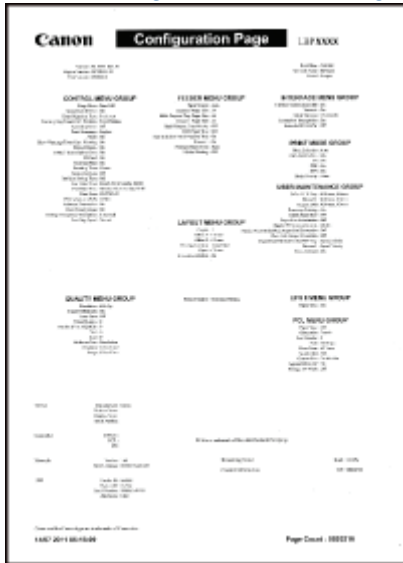

Printable	To <Question 5>
Not printable	If an error message is displayed, solve the problem following the message. ❖ "A Message Appears in the Control Panel"

<Question 5> Is the printer connected to the print server properly?

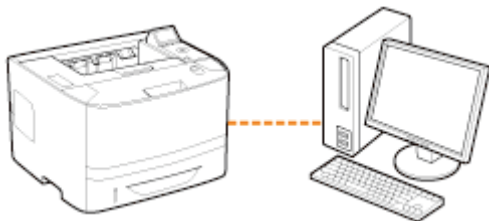

Connected	To <Question 6>
Unconnected	Connect them properly. ❖ "Connecting to a Computer"

<Question 6> Can your computer be connected to the print server or the shared printer?

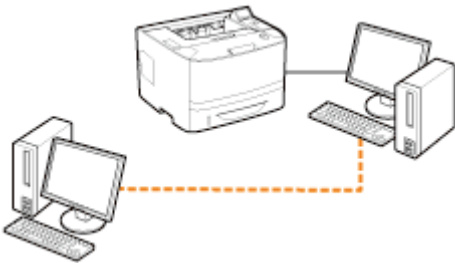

Can be connected	To <Question 7>
Cannot be connected	<ul style="list-style-type: none"> ❖ "The Print Server for Connection Cannot Be Found" ❖ "The Shared Printer Cannot Be Accessed"

<Question 7> Check the following points.

- The print server is connected to the network properly.
- The additional driver (alternate driver) is updated properly.
- Printing can be performed from the print server.



If printing does not work, proceed to <Question 8>.

<Question 8> Can you print a test page in Windows?

- ❖ "Basic Operations/Various Information for Windows"



Printable	There is no problem with the printer and driver. Check the printing preferences in the application.
Not printable	To <Question 9>

<Question 9> Is the printer on the print server displayed on the network?

- ❖ "Basic Operations/Various Information for Windows"

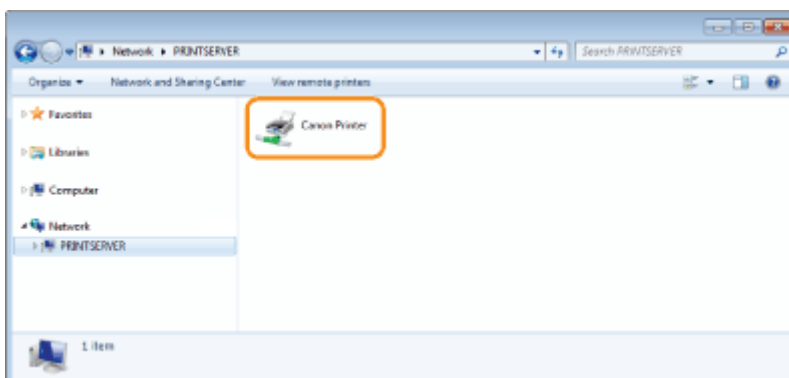

Displayed	To <Question 10>
Not displayed	Ask your network administrator about the problem.

<Question 10> Install the printer driver again.

For details on the procedure for installing the printer driver, see "Printer Driver Installation Guide."

For details on the procedure for viewing "Printer Driver Installation Guide", see "[Installation](#)."



If printing does not work, proceed to <Question 11>.

<Question 11> Can another client print?



Printable	Make resident software invalid including security software.
Not printable	Contact your local authorized Canon dealer.

The Print Server for Connection Cannot Be Found

04L9-0JF

Perform one of the following solutions according to the cause.

<Cause 1> The LAN cable is not connected properly.

Solution Connect the print server to the client computer with the LAN cable properly.

<Cause 2> The print server has not been started up.

Solution Start up the print server.

<Cause 3> The printer is not specified as a shared printer.

Solution Specify the printer as a shared printer.
For details, see the following item in "Printer Driver Installation Guide."
• "Installation" - "Print Server Settings"
For details on the procedure for viewing "Printer Driver Installation Guide", see "[Installation](#)."

<Cause 4> The user does not have permission to access the print server or printer.

Solution Ask your network administrator to change the user permissions.

<Cause 5> [Network discovery] is not enabled. (Windows Vista, 7, and Server 2008)

Perform either of the following procedures.

Windows Vista

1. From the [Start] menu, select [Control Panel].
2. Click [View network status and tasks].
3. Set [Network discovery] to [On].

Windows 7 Windows Server 2008 R2

1. From the [Start] menu, select [Control Panel].
2. Click [View network status and tasks].
3. Click [Change advanced sharing settings].
4. Specify [Turn on network discovery] in [Network discovery].

Windows Server 2008

1. From the [Start] menu, select [Control Panel].
2. Double-click [Network and Sharing Center].
3. Set [Network discovery] to [On].

The Shared Printer Cannot Be Accessed

04L9-OJH

Perform one of the following solutions according to the cause.

<Cause 1> The user of the computer to be used is not registered, or the password is not specified.

Solution

Register the user of the computer to be used or specify the password on the print server. For more details, ask your network administrator.

<Cause 2> The path to the network is not correct.

Solution 1

Check printers in the print server.

▣ "Basic Operations/Various Information for Windows"

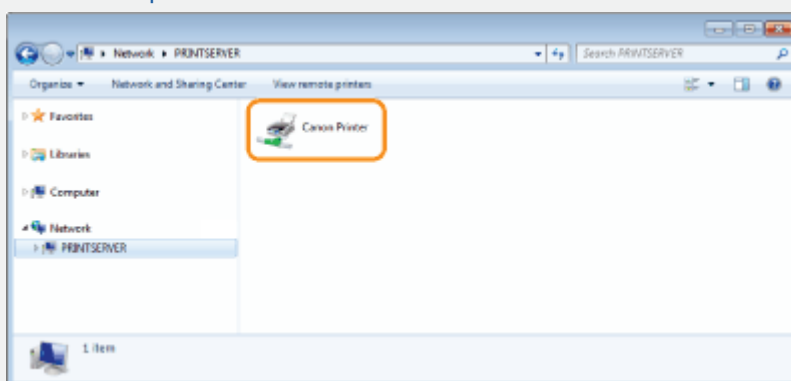

- **If the icon for this printer is not displayed**
Ask your network administrator about the problem.
- **If the icon for this printer is displayed**
You can install the printer driver by performing either of the following procedures and following the instructions on the screen.
 - Double-clicking the icon for this printer
 - Dragging and dropping the icon for this printer in the printer folder

Solution 2

If you want to specify the network path directly, check if the network path is specified correctly as "\\the print server name (the computer name of the print server)\the printer name."

The Printer Takes a Long Time to Start the Print Job

04L9-0JJ

Perform one of the following solutions according to the cause.

<Cause 1> The printer is cooling down to maintain print quality. (Especially after narrow paper is printed)

Solution

Wait a moment. The printer automatically cools down the inside. After cooling is completed, the printer resumes printing.

<Cause 2> This problem may occur in some applications depending on the processing type of the print data. (Windows 2000/XP/Server 2003)

Solution

If you are using the PCL/UFR II printer driver, performing the following procedure may be able to solve the problem.

- **UFR II Printer Driver**

1. Display the [Finishing] sheet.
2. Click [Advanced Settings].
3. Change the [EMF Spooling] setting.

- **PCL Printer Driver**

See Help of the PCL printer driver.

You Cannot Turn the Printer ON

04L9-0JK

Perform one of the following solutions according to the cause.

<Cause 1> The power plug is unplugged from the AC power outlet.

Solution Plug the power plug in the AC power outlet.

<Cause 2> The printer is plugged to an extension cord or multiple power strip.

Solution Plug the power plug directly in the AC power outlet.

<Cause 3> The breakers have tripped.

Solution Reset the breakers on the switch board.

<Cause 4> There is a break in the power cord.

Solution If the printer can be turned ON after replacing the power cord with one that is of the same type, and then purchase a new power cord and replace the broken one.

All the Indicators on the Network Interface Are Off

04L9-0JL

Perform one of the following solutions according to the cause.

<Cause 1> The LAN cable is not connected properly or broken.

Solution 1	Remove the LAN cable once, and then connect it again.
Solution 2	Replace the LAN cable with another one, and then connect it.

<Cause 2> The cable is connected to the UP-LINK (cascade) port on the hub.

Solution 1	Connect the LAN cable to the port on the hub with an " X " mark.
Solution 2	If the hub has an UP-LINK (cascade) switch, switch to " X."

<Cause 3> A cross LAN cable is being used.

Solution 1	Replace the cable with a straight LAN cable.
Solution 2	Connect the cross LAN cable to the UP-LINK (cascade) port on the hub. If the hub has an UP-LINK (cascade) switch, switch to the " = " side.

<Cause 4> Cannot communicate with the hub.

Solution 1	Make sure that the power of the hub is on.
Solution 2	Specify the communication settings for the print server according to the transmission speed of the connected hub. ❖ "Changing the Network Transmission Speed or Transfer Mode"

<Cause 5> The hardware of the printer is in an abnormal condition.

Solution	Contact your local authorized Canon dealer to request service.
-----------------	--

You Cannot Install the Printer Driver

04L9-0JR

NOTE

For Macintosh users

This section describes the procedure for Windows as an example.



For details on the procedure for Macintosh, see "Driver Guide."

If a symptom that is not indicated in this section occurs, see "Chapter 6 Troubleshooting" in Driver Guide.

For details on the procedure for displaying "Driver Guide", see "[Viewing the Driver Guide](#)."

If a problem occurs during the installation

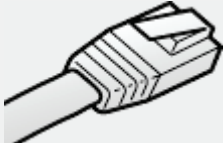
Select a problem during the installation from any of the following.

Connection with a USB cable 	<ul style="list-style-type: none">❖ "The Printer Is Not Recognized Automatically"
Connection with a LAN cable 	<ul style="list-style-type: none">❖ "The Printer Cannot Be Searched for"
Connection via the print server (Client) 	<ul style="list-style-type: none">❖ "The Print Server for Connection Cannot Be Found"❖ "The Shared Printer Cannot Be Accessed"

If the printer driver is not installed properly

Perform the following procedure.

Solution 1	<p>Install the printer driver again.</p> <p>For details on the procedure for uninstalling or installing the printer driver, see "Printer Driver Installation Guide."</p> <p>For details on the procedure for viewing "Printer Driver Installation Guide", see "Installation."</p>
Solution 2 (Only when connecting with USB)	<p>Uninstall the USB class driver, and then install the printer driver again.</p> <p>For details on the procedure for uninstalling the USB class driver and installing the printer driver, see "Printer Driver Installation Guide."</p> <p>For details on the procedure for viewing "Printer Driver Installation Guide", see "Installation."</p>

The Printer Is Not Recognized Automatically

04L9-0JS

Perform one of the following solutions according to the cause.

<Cause 1> The printer is not turned ON.

Solution Turn the printer ON.

<Cause 2> The USB cable is not connected properly.

Solution Make sure that the printer and computer are properly connected with the USB cable.
➤ ["Connecting to a Computer"](#)

<Cause 3> The USB cable was already connected and the printer was turned ON before the printer driver was installed.

Solution

Perform the following procedure.

1. Turn the printer OFF.
2. Disconnect the USB cable.
3. Connect the USB cable again.
4. While the following screen appears, turn the printer ON.

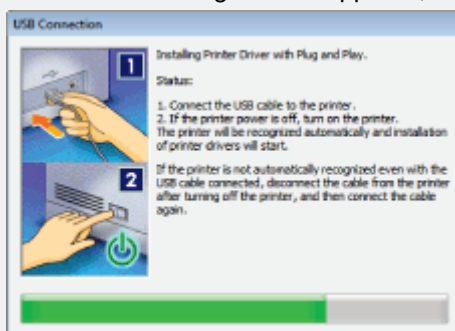

<Cause 4> An inappropriate USB cable is being used.

Solution

Use a USB cable that is appropriate for the USB interface environment of the printer and has the following symbol.



- † The following is the USB interface environment of this printer.
- Hi-Speed USB
 - USB

<Cause 5> The USB class driver is installed.

Solution

Uninstall the USB class driver.

For details, see the following item in "Printer Driver Installation Guide."

- "Appendix" - "If You Cannot Install a USB Class Driver"

For details on the procedure for viewing "Printer Driver Installation Guide", see "[Installation.](#)"

The Printer Cannot Be Searched for

04L9-0JU

If the printer cannot be searched for when you are in the process of installing the printer driver, perform the following procedure.

1

Make sure that the LAN cable is connected properly, and the printer is turned ON.

❖ "Connecting to a Computer"

2

Search for the printer on the network again.

❓ If the printer cannot be searched for (no devices are displayed) even by performing the above procedure

<Solution>

1. Set [Interface Selection] in [Network] to [On].
 - ❖ "[Setup] Menu ([Interface] Options)"
2. Set the IP address.
 - ❖ "Setting the IP Address (IP v. 4)"
 - ❖ "Setting IP v. 6"
3. Recover your printer from Sleep mode.
 - ❖ "Sleep Mode"

You Cannot Uninstall the Printer Driver

04L9-0JW

Perform the following procedure.

Solution 1	Use Uninstaller supplied with User Software CD-ROM to uninstall the printer driver. For details, see the following item in "Printer Driver Installation Guide." <ul style="list-style-type: none">• "Update/Uninstallation" - "Uninstalling the Printer Driver" For details on the procedure for viewing "Printer Driver Installation Guide", see " Installation ."
Solution 2 (Only when connecting with USB)	Uninstall the USB class driver. For details, see the following item in "Printer Driver Installation Guide." <ul style="list-style-type: none">• "Appendix" - "If You Cannot Install a USB Class Driver" For details on the procedure for viewing "Printer Driver Installation Guide", see " Installation ."

The Printer Driver Settings Cannot Be Changed

04L9-OJX

If [Spooling at Host] (whether the print data are processed in the computer) is set to [Disabled], you cannot change the driver settings because some options are unavailable.

To change the settings, set [Spooling at Host] to [Auto] using the following procedure.

1

Open the printer folder.

➤ "Basic Operations/Various Information for Windows"

2

Right-click the icon for this printer, and then select [Printer properties] or [Properties] from the pop-up menu.

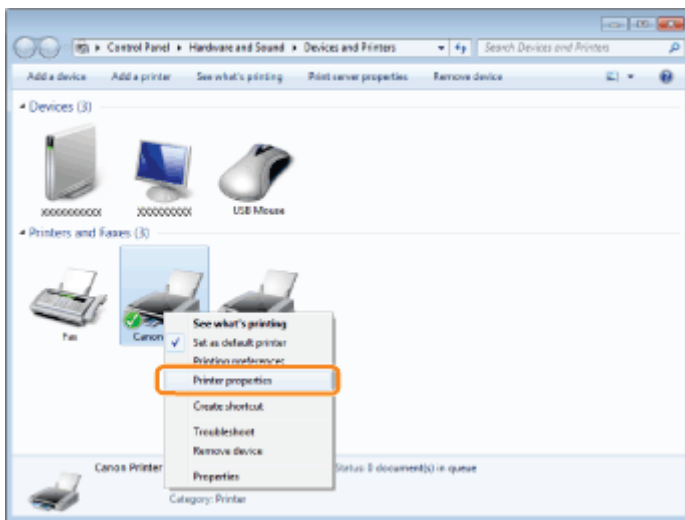

3

Change the setting for [Spooling at Host].

- (1) Display the [Device Settings] sheet.
- (2) Select [Auto] for [Spooling at Host].

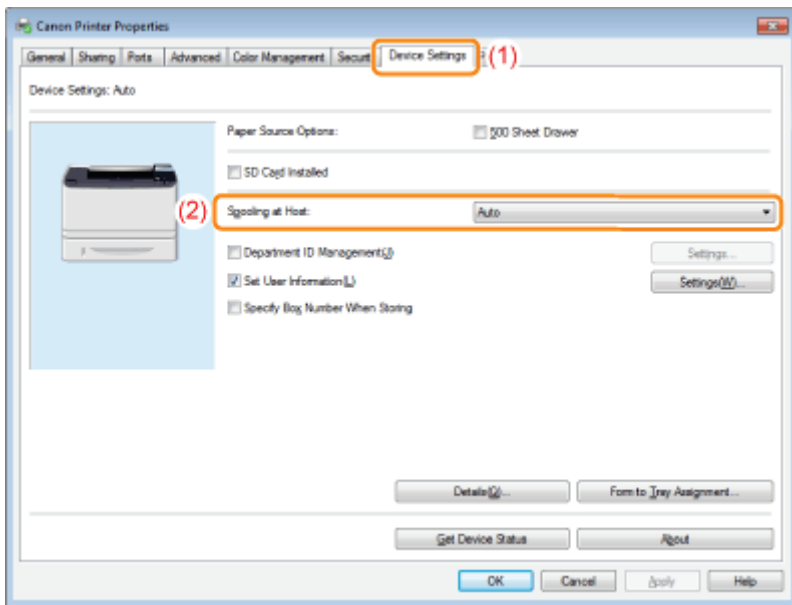

? If you cannot change the setting

You need administrative rights to change the setting.
Contact your system administrator.

4

Click [OK].

"Profiles" Cannot Be Selected or Edited

04L9-0JY

When the [Allow Profile Selection] and [Allow Setting Edition] check boxes are cleared, selecting and editing a "Profile" are restricted.

To select or edit a "Profile", select the check box using the following procedure.

1

Open the printer folder.

➤ "Basic Operations/Various Information for Windows"

2

Right-click the icon for this printer, and then select [Printer properties] or [Properties] from the pop-up menu.

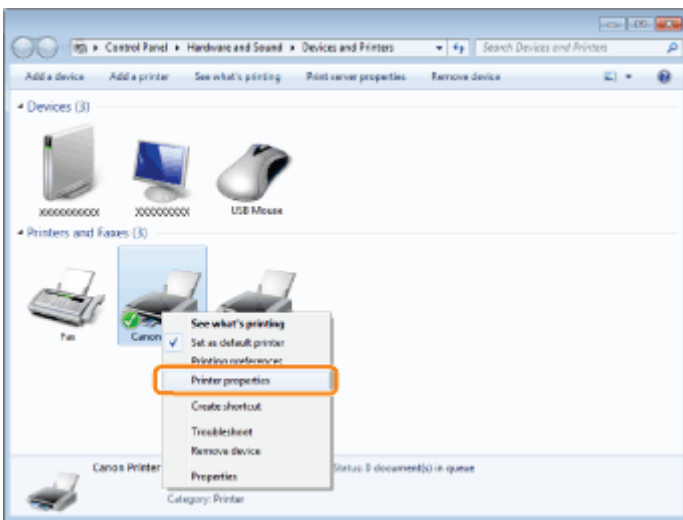

3

Change the settings for [Define Document Property].

- (1) Display the [Profile] sheet.
- (2) Select the [Allow Profile Selection] and [Allow Setting Edition] check boxes.

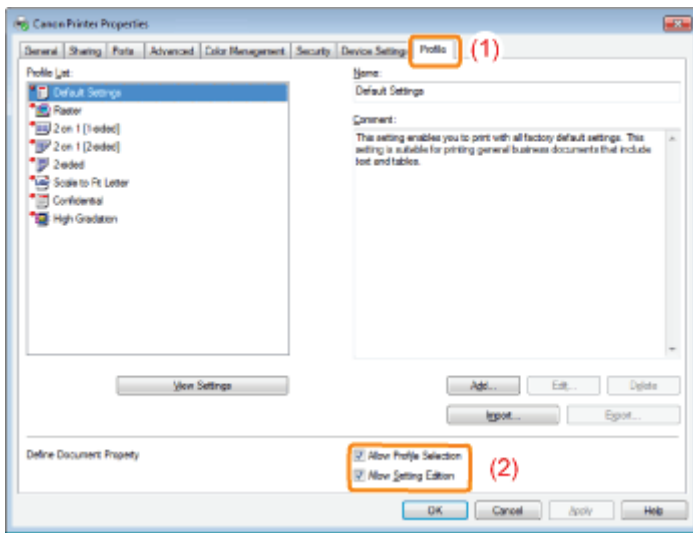

? If you cannot change the setting

You need administrative rights to change the setting.
Contact your system administrator.

4

Click [OK].

The Status of the Paper Feeder Cannot Be Obtained Automatically

04L9-0K0

If you cannot specify the settings for Drawer 2 in [Paper Source] in the printer driver, specify the status of the paper feeder using the following procedure.

NOTE

For Macintosh users

This section describes the procedure for Windows as an example.

For details on the procedure for Macintosh, see "Driver Guide."

For details on the procedure for displaying "Driver Guide", see "[Viewing the Driver Guide.](#)"

1

Open the printer folder.

 "Basic Operations/Various Information for Windows"

2

Right-click the icon for this printer, and then select [Printer properties] or [Properties] from the pop-up menu.

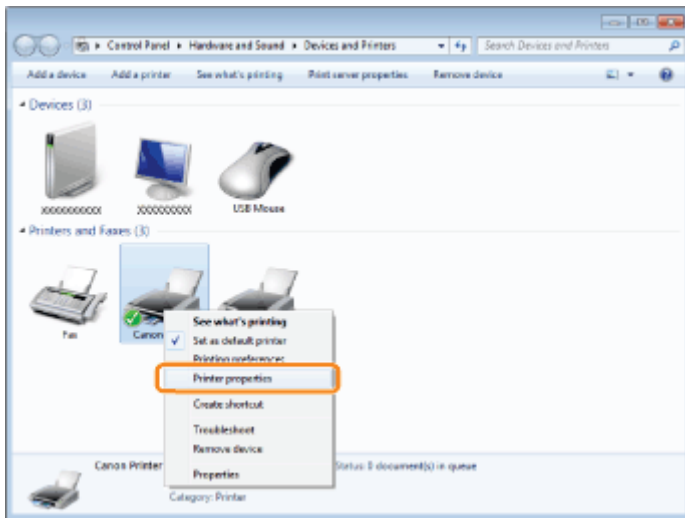

3

Obtain the status of the paper feeder.

- (1) Display the [Device Settings] sheet.
- (2) Click [Get Device Status].
- (3) Click [Yes] to obtain the status of the paper feeder.

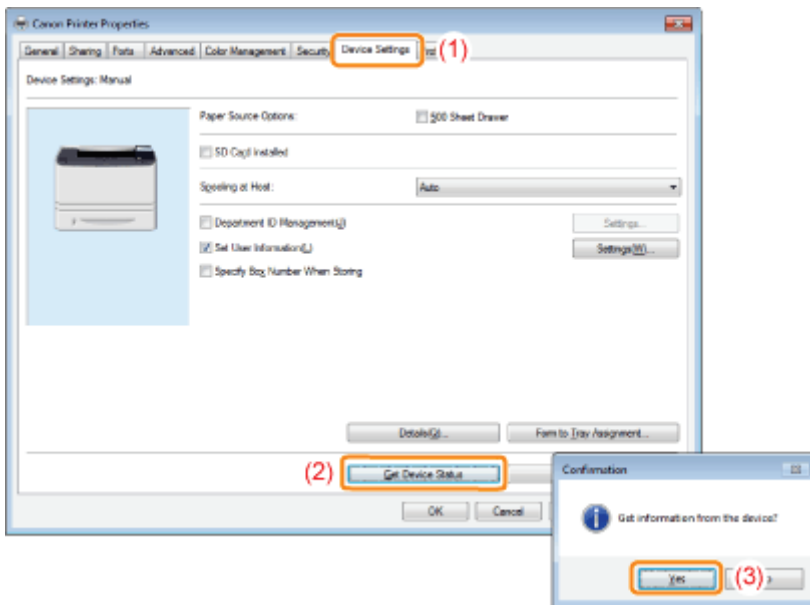

? If the status of the paper feeder is not obtained

Remove the paper feeder once, and then install it again.

If the status of the paper feeder cannot be obtained even by installing it again, see the following and make sure that the printer and computer can communicate with each other.

- ❖ "Printing Cannot Be Performed (USB Connection)"
- ❖ "Printing Cannot Be Performed (LAN Connection)"
- ❖ "Printing Cannot Be Performed (via the Print Server)"

4

Click [OK].

Paper Jams

04L9-0K1

Before removing jammed paper, see "Attention (Paper Jams)."

When a paper jam occurs, the printer beeps, displaying the message <Paper is jammed.> in the display.

† This section describes the procedure for when [Animated Instruction] is set to [On] (default setting).
If [Animated Instruction] is set to [Off], the above screen is not displayed.

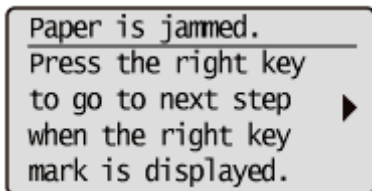

Messages appear one at a time. Confirm all of them.

As the messages disappear when the cover is open, take a note of them if required.



Remove the jammed paper according to the displayed message.

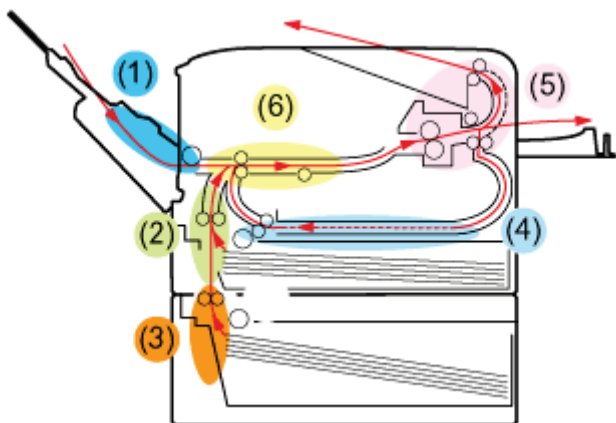

Paper Jam Area	Message	Clearance Procedure
(1) Multi-purpose tray	<MP Tray area>	❖ "Clearing Paper Jams (Multi-purpose Tray)"
(2) Drawer 1	<Drawer 1 area>	❖ "Clearing Paper Jams (Paper Drawer)"
(3) Drawer 2 (Only when the paper feeder is installed)	<Drawer 2 area>	❖ "Clearing Paper Jams (Paper Drawer)"
(4) Duplex print transport area	<2-Sided Delivery Area>	❖ "Clearing Paper Jams (Duplex Unit)"
(5) Inside the output area	<back cover area/Output area>	❖ "Clearing Paper Jams (Inside the Output Area)"
(6) Inside the front cover	<Front cover>	❖ "Clearing Paper Jams (Inside the Front Cover)"

Attention (Paper Jams)

04L9-0K2

Before removing the jammed paper, see "Important Safety Instructions."

CAUTION

Do not take your hands off the transport guide.

Do not take your hands off the transport guide until it moves back to its original position when tilting the transport guide toward you. The transport guide may snap back to its original position, and this may result in personal injury.

IMPORTANT

Leave the printer ON when removing the jammed paper.

If the power is turned OFF, the data being printed will be deleted.

Do not remove the jammed paper forcefully.

Removing jammed paper with excess force may cause the paper to tear or damage the inside of the printer. Remove the paper by pulling it gently.

If the paper is torn

Remove all remaining pieces of paper.

Do not touch the high-voltage contacts (A) or the electrical contacts (B).

This may result in damage to the printer.

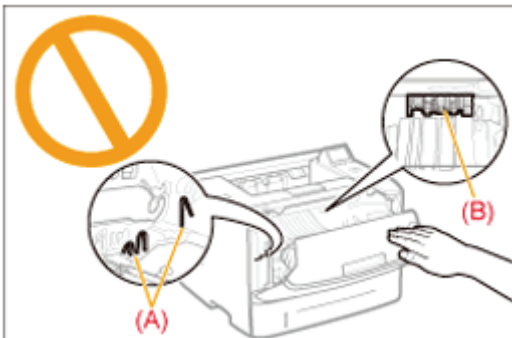

Do not touch the transfer roller (C).

Print quality may deteriorate.

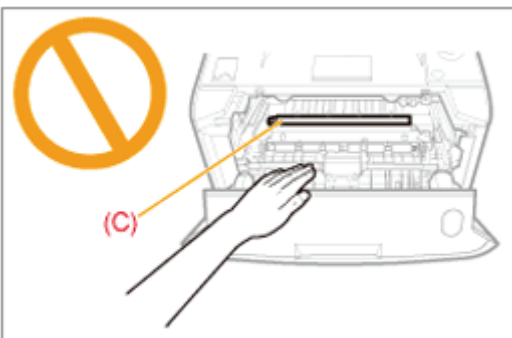

Do not touch the feed rollers (D).

This may result in damage to the printer or a printer error.

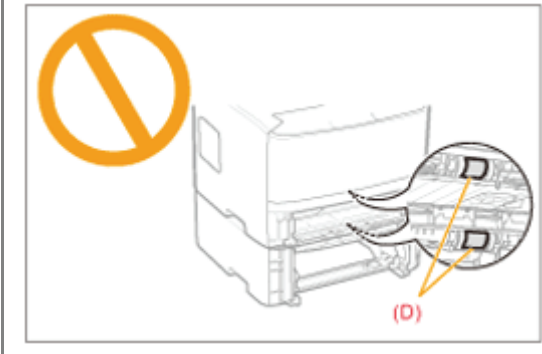

Clearing Paper Jams (Multi-purpose Tray)

04L9-0K3

Referring to the procedure on the display, follow the steps below to remove jammed documents.

1

Press [▶].

Paper is jammed.
Press the right key
to go to next step
when the right key
mark is displayed.

2

Remove the paper by pulling it gently.

If you cannot remove the paper easily, do not try to remove it forcefully but perform a procedure for another area which is displayed in a message.

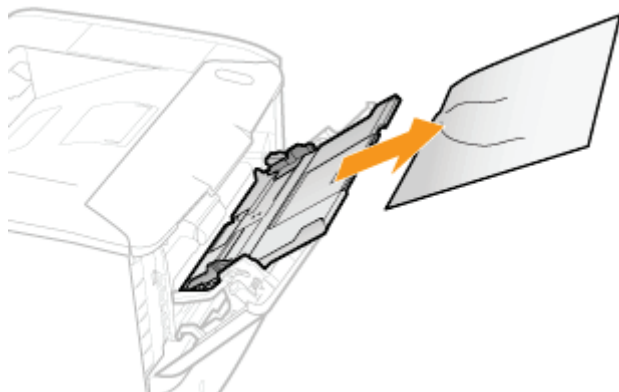

3

When the following screen appears, press [OK].

The machine is ready to print.

Is all of the jammed
paper removed?

End: Press OK
Previous: Press Back

☞ Next, proceed to the clearing procedure for another area which is displayed in the message.

- (1) "Clearing Paper Jams (Multi-purpose Tray)"
- (2) "Clearing Paper Jams (Paper Drawer)"
- (3) "Clearing Paper Jams (Duplex Unit)"
- (4) "Clearing Paper Jams (Inside the Output Area)"
- (5) "Clearing Paper Jams (Inside the Front Cover)"

Clearing Paper Jams (Paper Drawer)

04L9-0K4

Referring to the procedure on the display, follow the steps below to remove jammed documents.

1

Press [▶].

Paper is jammed.
Press the right key
to go to next step
when the right key
mark is displayed.

2

Pull out the paper drawer.

If the paper feeder is installed, pull out the paper drawer of the paper feeder also.

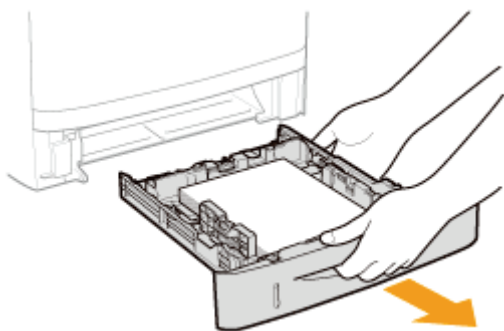

3

Remove the paper by pulling it gently.

If you cannot remove the paper easily, do not try to remove it forcefully but proceed to Step 4 and perform the clearing procedure for another area which is displayed in the message

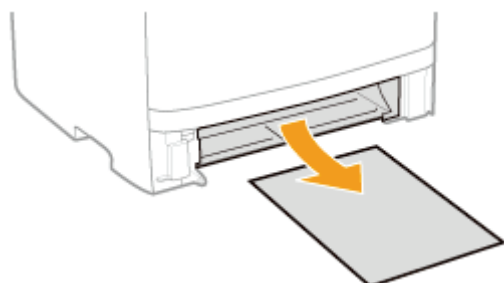

4

Set the paper drawer in the printer.

If the paper feeder is installed, insert the paper drawer of the paper feeder also.

5

When the following screen appears, press [OK].

The machine is ready to print.

Is all of the jammed
paper removed?

End: Press OK
Previous: Press Back

 Next, proceed to the clearing procedure for another area which is displayed in the message.

- (1) "Clearing Paper Jams (Multi-purpose Tray)"
- (2) "Clearing Paper Jams (Paper Drawer)"
- (3) "Clearing Paper Jams (Duplex Unit)"
- (4) "Clearing Paper Jams (Inside the Output Area)"
- (5) "Clearing Paper Jams (Inside the Front Cover)"

Clearing Paper Jams (Duplex Unit)

04L9-0K5

Referring to the procedure on the display, follow the steps below to remove jammed documents.

1

Press [▶].

Paper is jammed.
Press the right key
to go to next step
when the right key
mark is displayed.

2

Pull out the paper drawer.

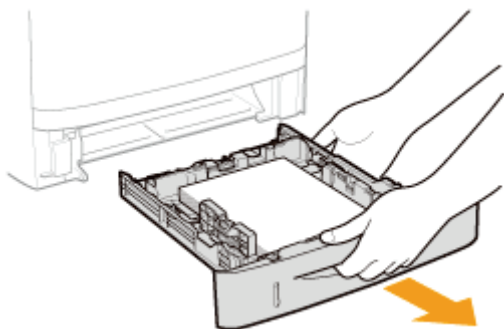

3

Holding the green tab (A), open the duplex print transport guide.

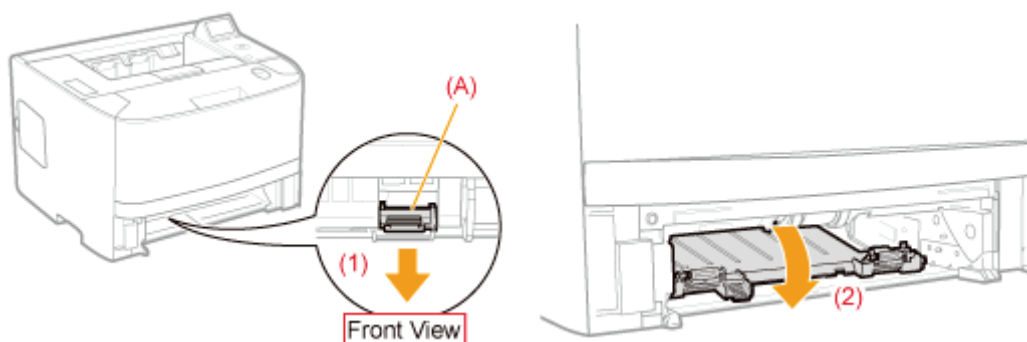

4

Remove the paper by pulling it gently.

If the jammed paper cannot be removed easily, do not try to remove it forcefully but proceed to Step 5.

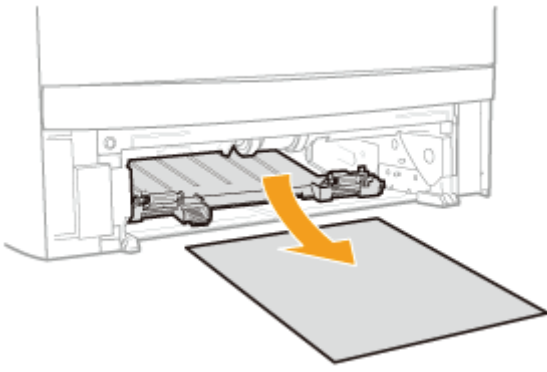

5

Holding the green tab, close the duplex print transport guide firmly.

Close it by pressing the both sides firmly.

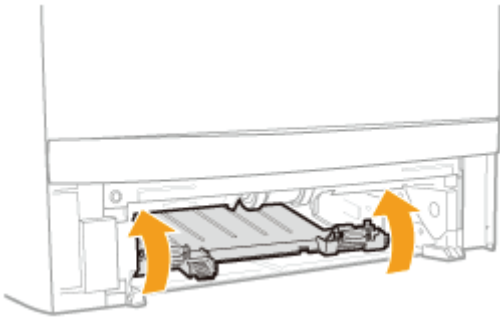

6

Set the paper drawer in the printer.

7

Open the duplex unit cover.

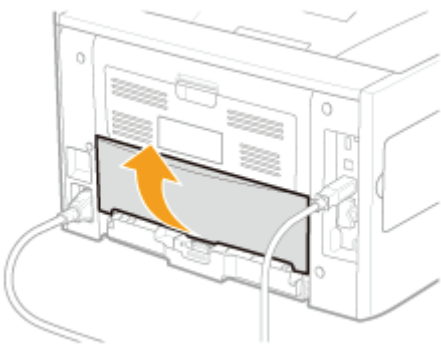

8

Remove the paper by pulling it gently.

If you cannot remove the paper easily, do not try to remove it forcefully but proceed to Step 9 and perform the clearing procedure for another area which is displayed in the message.

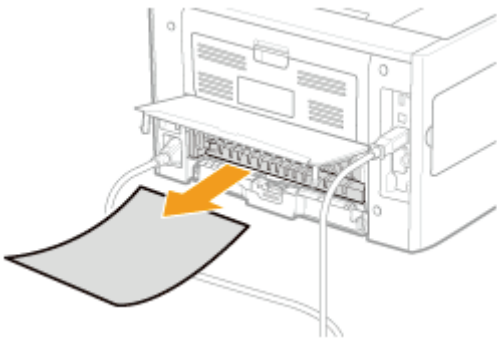

9

Close the duplex unit cover.

10

Open the front cover while pressing the open button.

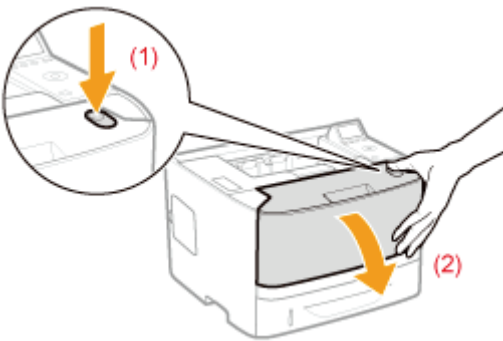

11

Close the front cover.

The machine is ready to print.

 Next, proceed to the clearing procedure for another area which is displayed in the message.

- (1) "Clearing Paper Jams (Multi-purpose Tray)"
- (2) "Clearing Paper Jams (Paper Drawer)"
- (3) "Clearing Paper Jams (Duplex Unit)"
- (4) "Clearing Paper Jams (Inside the Output Area)"
- (5) "Clearing Paper Jams (Inside the Front Cover)"

Clearing Paper Jams (Inside the Output Area)

04L9-0K6

Referring to the procedure on the display, follow the steps below to remove jammed documents.

1

Press [▶].

Paper is jammed.
Press the right key
to go to next step
when the right key
mark is displayed.

2

Open the rear cover.

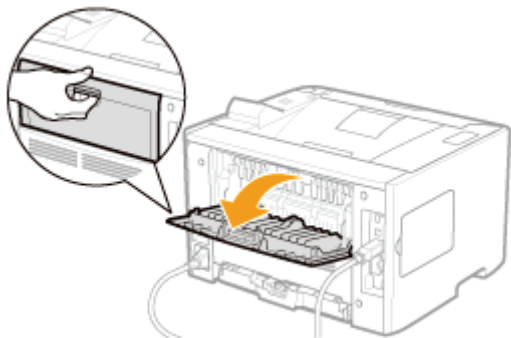

3

Remove the paper by pulling it gently.

If you cannot remove the paper easily, do not try to remove it forcefully but proceed to Step 4 and perform the clearing procedure for another area which is displayed in the message.

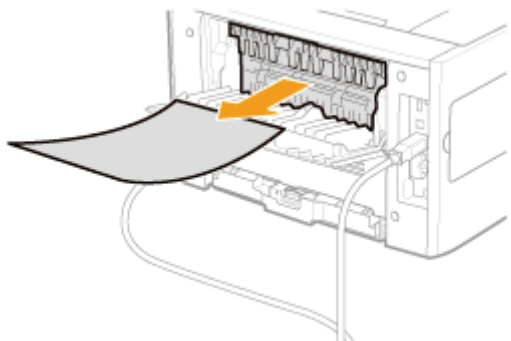

4

Close the rear cover.

Next, proceed to the clearing procedure for another area which is displayed in the message.

- (1) "Clearing Paper Jams (Multi-purpose Tray)"
 - (2) "Clearing Paper Jams (Paper Drawer)"
 - (3) "Clearing Paper Jams (Duplex Unit)"
 - (4) "Clearing Paper Jams (Inside the Output Area)"
 - (5) "Clearing Paper Jams (Inside the Front Cover)"
-

Clearing Paper Jams (Inside the Front Cover)

04L9-ORL

1

Press [▶].

Paper is jammed.
Press the right key
to go to next step
when the right key
mark is displayed. ▶

2

If you are using the multi-purpose tray, close it.

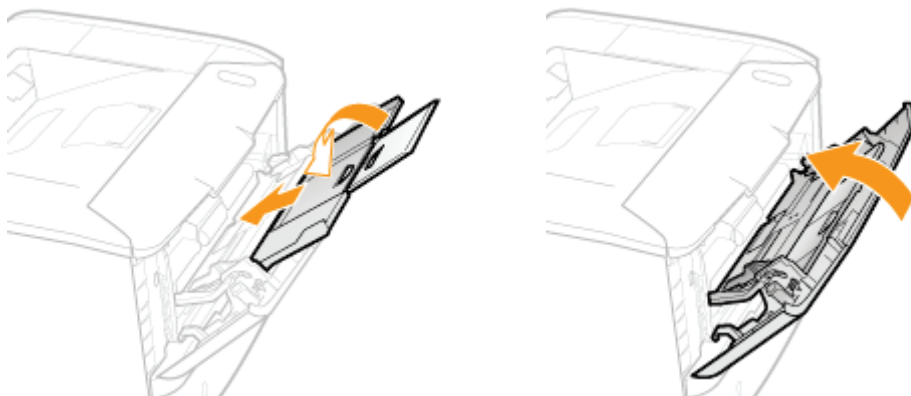

3

Open the front cover while pressing the open button.

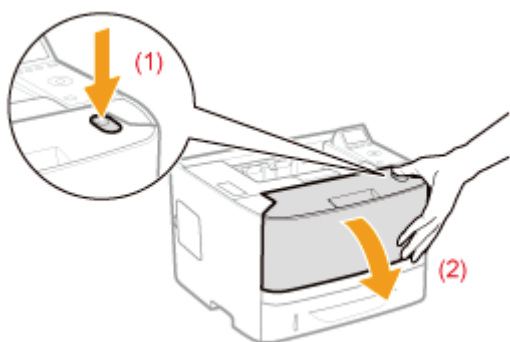

4

Remove the toner cartridge.

Immediately place the removed toner cartridge into the original protective bag or wrap it with a thick cloth.

† For details on handling the toner cartridge, see "[Attention \(Toner Cartridge\)](#)."

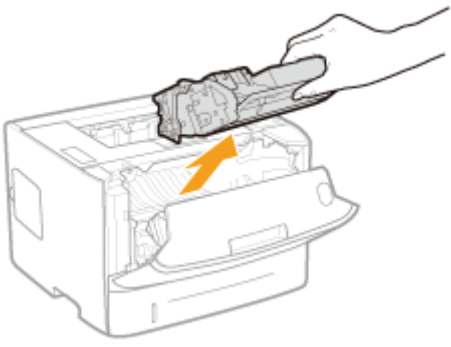

5

Holding the green tab (A), tilt the transport guide toward you.

Do not take your hands off the transport guide until it moves back to its original position in Step 7.

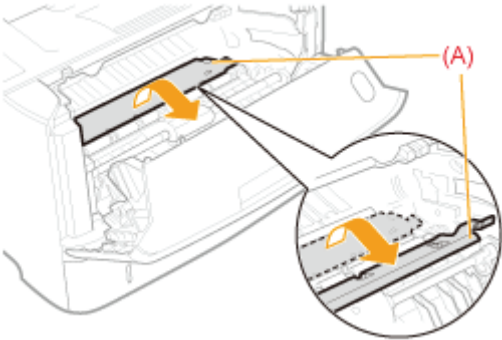

6

Remove the paper by pulling it gently.

Remove the jammed paper as horizontally as possible to prevent unfixed toner from spilling.

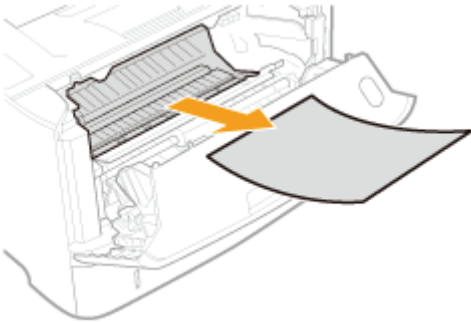

7

Move the transport guide back to its original position slowly.

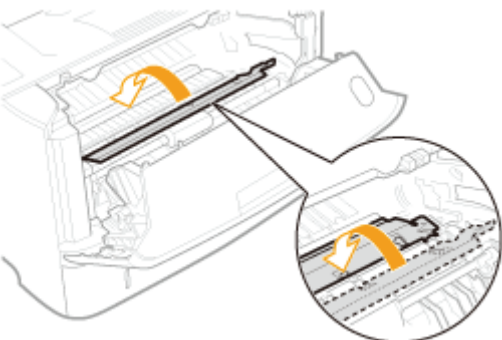

8

Install the toner cartridge.

Push the toner cartridge into the printer firmly until it touches the back of the printer while aligning (A) on both sides of the toner cartridge with the toner cartridge guides inside the printer.

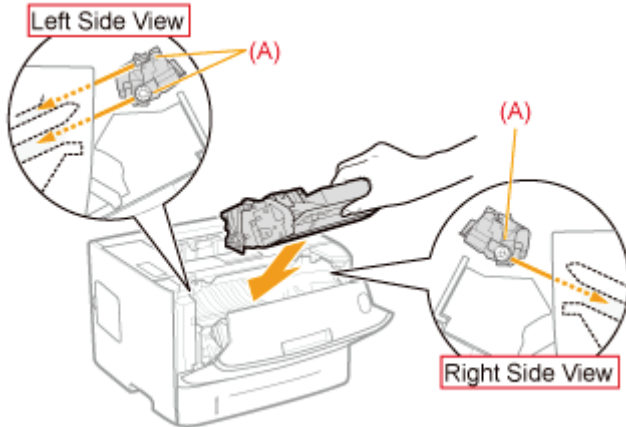

9

Close the front cover.

→ The message disappears, and the printer is ready to print.

? If you cannot close the front cover

Make sure that the toner cartridge is installed in the printer properly. Do not try to forcefully close the front cover, as this may damage the printer.

? If a message does not disappear

Paper may be jammed in another area. Check another area also and remove the paper.

- (1) "Clearing Paper Jams (Multi-purpose Tray)"
- (2) "Clearing Paper Jams (Paper Drawer)"
- (3) "Clearing Paper Jams (Duplex Unit)"
- (4) "Clearing Paper Jams (Inside the Output Area)"
- (5) "Clearing Paper Jams (Inside the Front Cover)"

† If the message does not disappear even after removing the paper, check that the rear cover is closed firmly.

The Message Indicator Is On

04L9-0K7

When the  (Message) indicator is on, implement the following solutions.

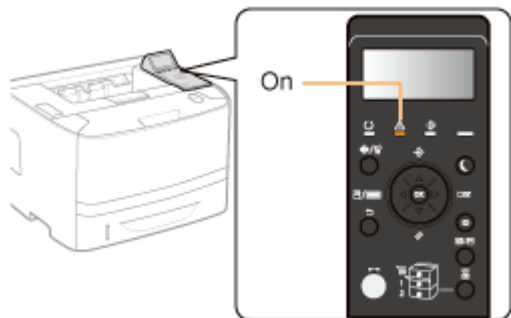

- ❖ The Service Call <Ennn-nnnn> Appears in the Display ("n" Represents an Alphanumeric Character)
- ❖ A Message Appears in the Display
- ❖ The Display Is Turned Off

The Service Call <Ennn-nnnn> Appears in the Display ("n" Represents an Alphanumeric Character)

Implement the following solutions according to the displayed message.

Message	Cause	Solution
<div style="border: 1px solid black; padding: 2px; margin-bottom: 2px;">E001-nnnn</div> <div style="border: 1px solid black; padding: 2px; margin-bottom: 2px;">E003-nnnn</div> ("n" represents an alphanumeric character.)	A problem occurred in the fixing unit.	Follow the procedure in " If a Fixing Unit Error Is Displayed ", and then contact your local authorized Canon dealer.
<div style="border: 1px solid black; padding: 2px; margin-bottom: 2px;">Ennn-nnnn</div> ("n" represents an alphanumeric character.)	A problem occurred inside the printer.	Following the procedure in " If a Service Error or a Message Is Displayed ", cycle the power of the printer.
<div style="border: 1px solid black; padding: 2px; margin-bottom: 2px;">F9-nn PwR OFF>ON</div> ("n" represents an alphanumeric character.)	A problem occurred while the printer was processing print data.	

If a Fixing Unit Error Is Displayed

1

Turn the printer OFF, and then disconnect the cables or cords from the printer.

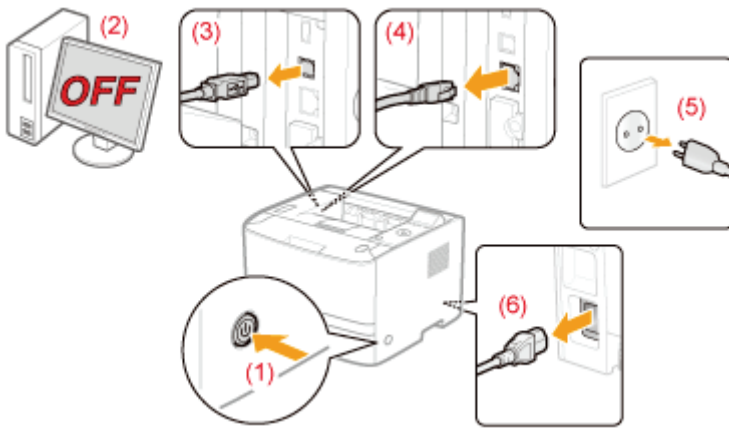

<How to disconnect the cable or cord>

USB cable*	(2) Turn the computer off. (3) Disconnect the cable from the printer.
LAN cable*	(4) Disconnect the cable from the printer.
Power cord	(5) Disconnect the power plug from the AC power outlet. (6) Disconnect the cord from the printer.

* Whether the cable is connected or not varies depending on your environment.

IMPORTANT

Do not turn ON the printer again.

A fixing unit error is displayed. Do not turn ON the printer after turning it OFF.

2

Contact your local authorized Canon dealer.

† If you are not sure what the problem is, contact your local authorized Canon dealer.

If a Service Error or a Message Is Displayed

1

Turn the printer OFF, wait for 10 seconds or longer, and then turn it ON again.

If the message does not reappear, the printer is ready.

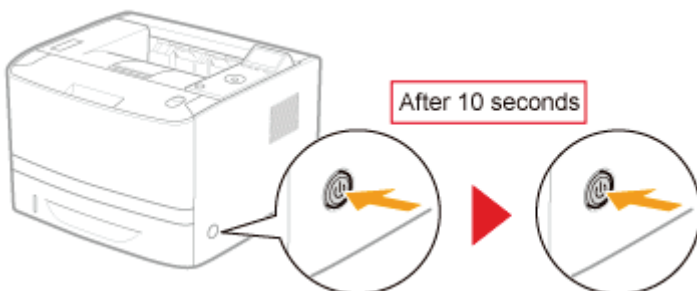

If the message reappears, you need to request service.

Follow the procedure below, and then contact your local authorized Canon dealer to request service.

2

Note down the error code displayed in the display.

3

Turn the printer OFF, and then disconnect the cables or cords from the printer.

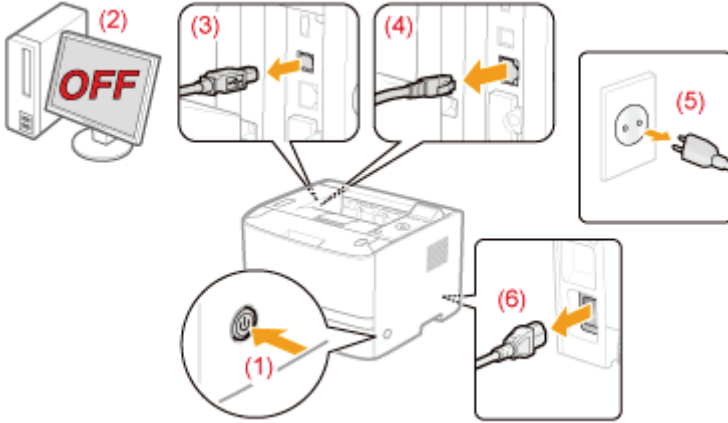

<How to disconnect the cable or cord>

USB cable*	(2) Turn the computer off. (3) Disconnect the cable from the printer.
LAN cable*	(4) Disconnect the cable from the printer.
Power cord	(5) Disconnect the power plug from the AC power outlet. (6) Disconnect the cord from the printer.

* Whether the cable is connected or not varies depending on your environment.

4

Contact your local authorized Canon dealer to request service.

When contacting your Canon dealer, please report also the error code which you noted down in Step 2.

† If you are not sure what the problem is, contact your local authorized Canon dealer.

A Message Appears in the Display

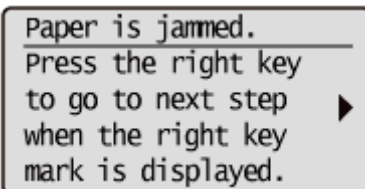

See the following and solve the problem according to the message.

❖ "A Message Appears in the Control Panel"

The Display Is Turned Off



The printer has entered Sleep Mode while it is offline.





- Release Sleep Mode.
 - ❖ "Sleep Mode"
 - Place the printer online.
 - ❖ "Online and Offline"
-

A Message Appears in the Control Panel

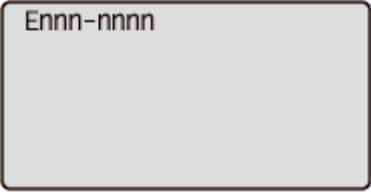
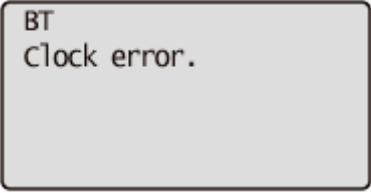
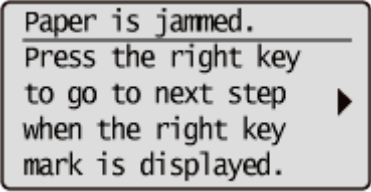
04L9-0K8

If an error is occurring for some reason during printing, a message appears in the display of the control panel. Perform solutions according to the displayed message.

<p>Service call message</p> 	<p>It is an error state in which the printer cannot print.</p>
<p>Warning message</p> 	<p>It is a warning state in which the printer can print, but some solution is required.</p> <ul style="list-style-type: none"> † Depending on the message type, the message does not appear if [Show Warnings] is set to [Off]. <ul style="list-style-type: none"> ❖ "[Setup] Menu ([Control Menu] Options)"
<p>Error message</p> 	<p>It is an error state in which the printer cannot print.</p>

Mark	Description
<p><Auto Error Skip></p>	<p>For a message with this mark, perform the following procedure according to the situation.</p> <ul style="list-style-type: none"> • When you want to skip an error (error skip) and continue to print <ol style="list-style-type: none"> 1. Press [] ( : Online) to skip the error. (Printing is continued.) 2. If print data is missing or is not printed properly, print again. <ul style="list-style-type: none"> † If [Auto Continue] is set to [On], you can skip the error automatically. <ul style="list-style-type: none"> ❖ "[Setup] Menu ([Control Menu] Options)" • If you want to cancel a job <ol style="list-style-type: none"> 1. Perform a soft reset. <ul style="list-style-type: none"> ❖ "Canceling the Process Currently Being Performed (Soft Reset)" 2. Solve the problem according to the displayed message (this item). 3. Press [] ( : Online) and print again.

NOTE

If multiple warning states are occurring at the same time

Warning messages are displayed alternately.

If an error state and warning state are occurring at the same time

A warning message is not displayed.

Service Call Message

- "Ennn-nnnn ("n" represents a number.) "
- "E001-nnnn ("n" represents a number.) "

- "E003-nnnn ("n" represents a number.) "
- "E004-nnnn ("n" represents a number.) "

Warning Message

- "1F Output tray is full."
- "1H Re-insert the toner cartridge."
- "80 Do not turn the main power OFF. (LBP6680x only)"
- "BT Clock error. "
- "EM E-Mail access error."
- "EM POP3 server error."
- "IE An unknown error has occurred."
- "IE Cannot analyze the certificate."
- "IE Change the password."
- "IE Check auth. settings"
- "IE No reply from the destination."
- "IE Set necessary authentication info."
- "IE Set the correct authentication info."
- "IE The certificate has expired."
- "IE The certificate is incorrect."
- "NW Competing IP add. found on the network."

Error Message

- "An error occurred while receiving. <Auto Error Skip> "
- "Cannot decode data. <Auto Error Skip> "
- "Cannot decode PDF data."
- "Cannot feed paper. "
- "Cannot perform 2-Sided Printing. <Auto Error Skip>"
- "Cannot print with the specified resolution. <Auto Error Skip> "
- "Cannot print. Reg. Table is full. <Auto Error Skip> "
- "Cannot read PDF data."
- "Cannot receive PDF data. Set the receivable size. <Auto Error Skip>"
- "Cannot start printing because job is restricted. <Auto Error Skip>"
- "Cannot store. <Auto Error Skip>"
- "Cannot verify. <Auto Error Skip> (LBP6680x only)"
- "Check paper size. "
- "Close XXXX cover. (XXXX shows the cover name)"
- "IEEE802.1X error. Set the necessary auth. information."
- "Image browse data error."
- "Image data error. "
- "Insert toner cartridge."
- "Key management file is corrupt or deleted."
- "Load paper. "
- "Not enough download memory. <Auto Error Skip> "
- "Not enough memory for PDF processing."
- "Not enough memory for XPS processing. <Auto Error Skip>"
- "Not enough spool memory. <Auto Error Skip>"
- "Not enough system memory. <Auto Error Skip> "
- "Not enough work memory. <Auto Error Skip> "
- "Output tray is full. Remove paper. "
- "Paper is jammed. "
- "PDF error. "
- "PDF font error."
- "PDF print range error."
- "Print data version error."
- "55 SD Card error. <Auto Error Skip>"
- "56 SD Card error."
- "Set below paper."
- "Set cleaning paper and press the Online key. <Auto Error Skip> "
- "Syntax error. "
- "XPS document data error. <Auto Error Skip> (LBP6680x only)"
- "XPS font data error. <Auto Error Skip>"
- "XPS image data error. <Auto Error Skip>"
- "XPS page data error. <Auto Error Skip>"
- "XPS print range error. <Auto Error Skip>"
- "XPS rendering error."
- "XPS unsupported image error. <Auto Error Skip>"
- "A4 nn Error ("nn" represents two-digit alphanumeric characters.) "
- "A5 nn Error ("nn" represents two-digit alphanumeric characters.) "
- "A7 nn ERROR ("nn" represents two-digit alphanumeric characters.) "
- "D7 nn Error ("nn" represents two-digit alphanumeric characters.) "
- "D8 nn Error ("nn" represents two-digit alphanumeric characters.) "
- "D9 nn Error ("nn" represents two-digit alphanumeric characters.) "

Ennn-nnnn ("n" represents a number.)

<Cause> A problem is occurring inside the printer.

Solution Solve the problem following the instructions in "If a Service Error or a Message Is Displayed."

E001-nnnn ("n" represents a number.)

<Cause> A problem is occurring with the fixing unit of the printer.

Solution

Follow the procedure in "If a Fixing Unit Error Is Displayed" in "[The Message Indicator Is On](#)", and then contact your local authorized Canon dealer.

E003-nnnn ("n" represents a number.)

<Cause> A problem is occurring with the fixing unit of the printer.

Solution

Follow the procedure in "If a Fixing Unit Error Is Displayed" in "[The Message Indicator Is On](#)", and then contact your local authorized Canon dealer.

E004-nnnn ("n" represents a number.)

<Cause> A problem is occurring with the fixing unit of the printer.

Solution

Follow the procedure in "If a Fixing Unit Error Is Displayed" in "[The Message Indicator Is On](#)", and then contact your local authorized Canon dealer.

1F Output tray is full.

<Cause> The output tray is filled to the limit.

Solution

Remove the paper in the output tray.

1H Re-insert the toner cartridge.

<Cause> There is a possibility that the toner cartridge is not installed properly.

Solution 1

Remove the toner cartridge, and then reinstall it properly.

Solution 2

If <1H Check toner connect.> appears and there is a problem with the print quality even after applying Solution 1, remove the toner cartridge, and then replace it with a new one.
➤ "[Toner Cartridge Replacement](#)"

80 Do not turn the main power OFF. (LBP6680x only)

<Cause> A MEAP application is running.

Solution

Wait until the message disappears.

BT Clock error.

<Cause> The clock in this printer has a problem.

Solution

Though printing is possible as is, logs such as the job histories cannot be recorded correctly. Contact your local authorized Canon dealer.

EM E-Mail access error.

<Cause> The printer could not connect to the POP3 server because an error had occurred in its hard

disk.

Solution Clear the hard disk error on the POP3 server.

EM POP3 server error.

<Cause> The printer could not connect to the POP3/SMTP server when printing e-mails, or the settings for the POP3/SMTP server are not correct.

Solution Check the error in detail using the Remote UI or Network Status Print.
➤ ["Receiving E-mail Data on the Mail Server and Printing \(E-mail Print\)"](#)

IE An unknown error has occurred.

<Cause> An unknown IEEE802.1X authentication error has occurred.

Solution Restart the printer. If the error message still appears after restarting this printer, contact your local authorized dealer.

IE Cannot analyze the certificate.

<Cause> During IEEE802.1X authentication, analysis of the certificate received from the authentication server failed.

Solution Check the authentication server's certificate.

IE Change the password.

<Cause> The password used for IEEE802.1X authentication has expired.

Solution Change the password registered in the authentication server, and reset the IEEE802.1X authentication password.
➤ ["Setting IEEE802.1X Authentication"](#)

IE Check auth. settings

The printer and the authentication server use different IEEE802.1X authentication systems.

Solution Change IEEE802.1X authentication systems.
➤ ["Setting IEEE802.1X Authentication"](#)

IE No reply from the destination.

<Cause> During IEEE802.1X authentication, an error occurred while communicating with the authentication server.

Solution Check to see if the cable is disconnected.

IE Set necessary authentication info.

<Cause> There is information missing from the IEEE802.1X authentication settings.

Solution Check the IEEE802.1X settings, and reconfigure them.
➤ ["Setting IEEE802.1X Authentication"](#)

IE Set the correct authentication info.

<Cause> An error was returned from the authentication server because the certificate used for IEEE802.1X authentication is not correct.

Solution 1 The certificate used for TLS authentication is not correct. Check the certificate, and reconfigure it.
➤ ["Setting IEEE802.1X Authentication"](#)

Solution 2 If the printer's certificate is correct, check the authentication server's CA certificate.

IE The certificate has expired.

<Cause> During IEEE802.1X authentication, the certificate received from the authentication server was an expired certificate.

Solution 1 Check the authentication server's certificate.

Solution 2 Check the printer's and the authentication server's time settings.
➤ ["Turning the Power On and Specifying a Language"](#)

IE The certificate is incorrect.

<Cause> During IEEE802.1X authentication, an error occurred as a result of the verification by the CA certificate of the certificate received from the authentication server .

Solution 1 Check the authentication server's certificate.

Solution 2 Install the CA certificate in the printer.
➤ ["Security Settings"](#)



NW Competing IP add. found on the network.

<Cause> The IPv4 address set for the printer overlaps with another host on the network.

Solution Change the printer's IPv4 address and restart.
➤ ["Setting the IP Address \(IP v. 4\)"](#)

An error occurred while receiving. <Auto Error Skip>

<Cause> The printer received any unanalyzable data while it is receiving a job, or it timed out.

Solution 1 Press [] ( : Online) to cancel printing, and then print again.

Solution 2 A problem may be occurring in the network you are using. Check the status of the network that you are using.

Cannot decode data. <Auto Error Skip>

<Cause> The printer could not analyze encrypted secured print data.

Solution Perform a soft reset using the Reset menu, and then print again.

Cannot decode PDF data.

<Cause 1> An incorrect password was entered to print the PDF data.

Solution	Enter the correct password.
-----------------	-----------------------------

<Cause 2> The PDF data security settings do not permit printing.

Solution	Change the settings to permit printing.
-----------------	---

Cannot feed paper.

<Cause> Paper of the size or type that cannot be fed from the multi-purpose tray or paper drawer is specified.

Solution 1	If a paper source is specified, press [●] (📄 : Feeder Selection), and then set [Paper Source] to [Auto]. ➤ "[Select Feeder] Menu"
Solution 2	Press [●] (📄 : Feeder Selection) to select another paper source.
Solution 3	Load paper appropriate for the paper source. ➤ "Usable Paper"
Solution 4	Specify the following items. <ul style="list-style-type: none">• [Standard Paper Size]• [Default Paper Type] ➤ "[Setup] Menu ([Paper Source] Options)"
Solution 5	Press [○] (⬅➡ : Online), and then print from the currently selected paper source. However, this may result in deterioration in print quality.

Cannot perform 2-Sided Printing. <Auto Error Skip>

<Cause> The printer received 2-sided printing data of paper sizes (including the orientation) or paper types unavailable for automatic 2-sided printing.

Solution 1	Press [○] (⬅➡ : Online) to continue printing. However, the data on each side is printed on two pages.
Solution 2	Perform the following procedure. <ol style="list-style-type: none">1. Perform a soft reset. ➤ "Canceling the Process Currently Being Performed (Soft Reset)"2. Change the setting to a paper size or type available for automatic 2-sided printing, and then print again.

Cannot print with the specified resolution. <Auto Error Skip>



<Cause> The printer cannot process the data because it is too complicated.

Solution 1	Press [○] (⬅➡ : Online) to continue printing. In this case, the printer prints with the image quality level being lowered.
Solution 2	Perform the following procedure. <ol style="list-style-type: none">1. Perform a soft reset. ➤ "Canceling the Process Currently Being Performed (Soft Reset)"

2. Set [Gradation Level] to [High 1], and then print again.
 - ❖ "[Setup] Menu ([Quality] Options)"

Cannot print. Reg. Table is full. <Auto Error Skip>

<Cause> The total number of binders inside a single job exceeds 16, or the number of documents inside a single binder exceeds 16.

Solution 1 Press [] ( : Online) to continue printing. However, the data may not be printed properly.

Solution 2 Confirm the data to be printed, and then print again.



Cannot read PDF data.

<Cause> An error has occurred when the PDF data was read.

- Solution** Perform the following procedure.
1. Perform a soft reset.
 - ❖ "Canceling the Process Currently Being Performed (Soft Reset)"
 2. Print the PDF data in a format which this printer supports again.

Cannot receive PDF data. Set the receivable size. <Auto Error Skip>

<Cause> There is not sufficient free space to print the PDF file using the direct print function.

Solution 1 Press [] ( : Online) to cancel the job. Afterward, perform the following processes (decreasing the size of the PDF file), and then print again.



- Optimizing the PDF file
- Dividing the PDF file into multiple files

Solution 2 Send the file again using one of the following methods (LBP6680x only).

- Insert the SD card into the slot and send the file again.
- Send the file directly from the USB memory device.
 - ❖ "Installing SD Card (LBP6680x Only)"
 - ❖ "Printing Files Directly from USB Memory Devices (USB Direct Print) (LBP6680x Only)"

Cannot start printing because job is restricted. <Auto Error Skip>



<Cause> Print job restrictions are set.

Solution Press [] ( : Online) to cancel the job. If print job restrictions are set, only the data stored in a box can be printed. Store the data you want to print in a box.

- ❖ "Setting Restrictions for Print Jobs"

Cannot store. <Auto Error Skip>

<Cause 1> [SD Card] in the Control Menu options in the Setup menu is set to [Off].

- Solution** Perform the following procedure.
1. Cancel printing by pressing [] ( : Online).
 2. Set [SD Card] to [On] and print again.

❖ "[Setup] Menu ([Control Menu] Options)"

<Cause 2> The number of the jobs exceeded the amount of jobs the printer can save (You can save up to 100 jobs in the SD card.)

Solution 1 The printer is ready to print by pressing [] (↔ : Online), ignoring the print data.

Solution 2 Delete unnecessary stored jobs.

<Cause 3> The number of the jobs exceeded the number of jobs you can save in the SD card.

Solution 1 The printer is ready to print by pressing [] (↔ : Online), ignoring the print data.

Solution 2 Delete unnecessary stored jobs.

<Cause 4> The specified box number is not correct.

Solution Specify the correct box number.

Cannot verify. <Auto Error Skip> (LBP6680x only)

<Cause 1> The department ID and password entered for your job did not match the department ID and password registered on the machine.

Solution Print your job again by entering the correct department ID and password.

<Cause 2> Printing jobs with unknown IDs are disallowed.

Solution Allow print jobs with unknown IDs from the Remote UI.
❖ "Specifying an ID for Each Department (LBP6680x Only)"

Check paper size.

<Cause 1> The size of the paper loaded in a paper source is different from the following settings.

- Setting for [Output Size] in the [Page Setup] sheet in the printer driver
- [MP Tray Paper Size], [Drawer 1 Size] or [Drawer 2 Size] in the [Select Feeder] menu

Solution Specify the setting properly.
❖ "Registering the Paper Size"
❖ "Configuring the Printer Driver and Printing"

<Cause 2> When the following settings in the [Select Feeder] menu are set to [Mixed Sizes], custom size paper whose long edges are 215.9 mm or less is loaded in portrait orientation and printed (only when the UFR II printer driver is used).

- [MP Tray Paper Size]
- [Drawer 1 Size]
- [Drawer 2 Size]

Solution Load the paper in landscape orientation, and then print again.

<Cause 3> When the UFR II printer driver was not used, custom size paper was loaded in landscape orientation to be printed.



Solution Load the paper in portrait orientation, and then print again.

<Cause 4> [Check Paper Size] in the common [Setup] menu ([User Maintenance] options) is set to [On].

Solution Set [Check Paper Size] to [Off], and then print again.
➤ "[Setup] Menu ([User Maintenance] Options)"

Close XXXX cover. (XXXX shows the cover name)

<Cause> A cover is open.

Solution Close the cover firmly. If the printer is not online, press [] ( : Online).

IEEE802.1X error. Set the necessary auth. information.

<Cause> There is information missing from the IEEE802.1X authentication settings.

Solution Check the IEEE802.1X settings, and reconfigure them.
➤ "Setting IEEE802.1X Authentication"

Image browse data error.

<Cause> Data which this printer cannot process is included in TIFF data.

Solution 1
(LBP6680x only)

Perform the following procedure.

1. Install the SD card.
➤ [Installing SD Card](#)
2. On the control panel, select [Imaging] → [Print Guarantee] → [On].
➤ [\[Setup\] Menu \(\[Imaging\] Options\)](#)
3. Restart the printer.





Solution 2 This printer cannot print the data. Press [] ( : Online) to cancel the job.

Image data error.

<Cause> Data which this printer cannot process is included in TIFF data or JPEG data.

Solution This printer cannot print the data. Press [] ( : Online) to cancel the job.

Insert toner cartridge.

<Cause> The toner cartridge is not installed or installed improperly.

Solution Install the toner cartridge properly.
➤ ["Toner Cartridge Replacement"](#)

Key management file is corrupt or deleted.

<Cause> The file related to key management is broken.

Solution	Perform the following procedure.
	1. Select [Network] → [Remote UI Settings] → [SSL] using the control panel, then make sure that [SSL] is set to [Off].
	2. Restart the printer, and then regenerate the key and certificate and specify the settings for SSL from the Remote UI. <ul style="list-style-type: none"> ➤ "Security Settings"
	3. Restart the printer.

Load paper.

<Cause> Paper of the size specified in the application is not loaded in the paper source (in all the paper sources when [Paper Source] is set to [Auto] and in the specified paper source when the setting is fixed).

Solution 1	Refill or load paper.
Solution 2	Press [●] (☰ : Feeder Selection), and then select other paper source for the same paper size or larger paper size. <ul style="list-style-type: none"> ➤ "[Select Feeder] Menu"

Not enough download memory. <Auto Error Skip>

<Cause> The memory for registering overlay forms and custom characters ran out and overflowed.

Solution 1	Press [○] (↔ : Online) to continue printing. However, the overflowed data cannot be registered.
Solution 2	Perform the following procedure. <ol style="list-style-type: none"> 1. Perform a soft reset. <ul style="list-style-type: none"> ➤ "Canceling the Process Currently Being Performed (Soft Reset)" 2. After the soft reset, either perform a hard reset or turn the printer back ON, increase memory capacity and print again. (All data in the memory will be erased.) <ul style="list-style-type: none"> ➤ "Canceling All the Jobs (Hard Reset)"

Not enough memory for PDF processing.

<Cause> There is not enough memory to process a PDF file.

Solution	Perform the following procedure.
	1. Perform a soft reset. <ul style="list-style-type: none"> ➤ "Canceling the Process Currently Being Performed (Soft Reset)"
	2. Decrease the size of the PDF file or divide it into multiple files, and then print again.
	† The PDF data may be printed properly by opening it from an application and using the printer driver.

Not enough memory for XPS processing. <Auto Error Skip>



<Cause> There is not enough memory for XPS processing.

Solution 1	Press [○] (↔ : Online), and continue printing. However, the data that generated the error will not be
-------------------	---

	printed correctly.
Solution 2	If images such as Progressive JPEG are handled inside the XPS, convert them to TIFF or Baseline JPEG and then print.



Not enough spool memory. <Auto Error Skip>

<Cause> Because spool memory ran out, the printer cannot print.

Solution 1	Press [] ( : Online) to continue printing. However, the page with which an error is occurring is not printed.
Solution 2	Perform the following procedure. <ol style="list-style-type: none"> 1. Perform a soft reset. <ul style="list-style-type: none"> ❖ "Canceling the Process Currently Being Performed (Soft Reset)" 2. Specify the paper size smaller, and then print again.
Solution 3	Perform the following procedure. <ol style="list-style-type: none"> 1. Perform a soft reset. <ul style="list-style-type: none"> ❖ "Canceling the Process Currently Being Performed (Soft Reset)" 2. Set [Gradation Level] to [Standard], and then print again. <ul style="list-style-type: none"> ❖ "[Setup] Menu ([Quality] Options)"
Solution 4	If [2-Sided Printing] is set to [On], specify [Off], and then print again. <ul style="list-style-type: none"> ❖ "[Setup] Menu ([Paper Source] Options)"
Solution 5	Change the setting for [Halftones], and then print again. <ul style="list-style-type: none"> ❖ "[Setup] Menu ([Quality] Options)"



Not enough system memory. <Auto Error Skip>

<Cause> The work memory required for the printer process ran out while the system was processing the data (mainly the graphics data and text data).

Solution 1	Press [] ( : Online) to continue printing. However, the data with which an error is occurring is not printed properly.
Solution 2	Perform the following procedure. <ol style="list-style-type: none"> 1. Perform a soft reset. <ul style="list-style-type: none"> ❖ "Canceling the Process Currently Being Performed (Soft Reset)" 2. After the soft reset, either perform a hard reset or turn the printer back ON, increase memory capacity and print again. (All data in the memory will be erased.) <ul style="list-style-type: none"> ❖ "Canceling All the Jobs (Hard Reset)"

Not enough work memory. <Auto Error Skip>

<Cause> The work memory for each print mode cannot be secured.

	Press [] ( : Online) to continue printing. However, the data with which an error is occurring is not printed properly.
	

Solution 1**IMPORTANT****When continuing printing by pressing [] ( : Online)**

Be aware that the data of overlay or macro that is already registered may be deleted.

Solution 2

Perform the following procedure.

1. Perform a soft reset.
 - "Canceling the Process Currently Being Performed (Soft Reset)"
2. After the soft reset, either perform a hard reset or turn the printer back ON, increase memory capacity and print again. (All data in the memory will be erased.)
 - "Canceling All the Jobs (Hard Reset)"

Output tray is full. Remove paper.



<Cause> The output tray is filled to the limit.

Solution Remove the paper in the output tray.

Paper is jammed.



<Cause> Paper is jammed inside the printer.

Solution

Remove the jammed paper and set the paper drawer and covers to the original position. If the printer is not online, press [] ( : Online).

- "Clearing Paper Jams (Multi-purpose Tray)"
- "Clearing Paper Jams (Paper Drawer)"
- "Clearing Paper Jams (Duplex Unit)"
- "Clearing Paper Jams (Inside the Output Area)"

IMPORTANT

- If paper jams occur at multiple areas at the same time, the areas appear in the display by rotation.
- If you removed the jammed paper without opening any cover, be sure to open and close the front cover once, and then press [] ( : Online).

PDF error.

<Cause> PDF data which this printer cannot process was sent.

Solution

Perform the following procedure.

1. Perform a soft reset.
 - "Canceling the Process Currently Being Performed (Soft Reset)"
2. Print the PDF data in a format which this printer supports again.

PDF font error.

<Cause> PDF font which this printer cannot process was sent.

Solution

Perform the following procedure.

1. Perform a soft reset.
 - "Canceling the Process Currently Being Performed (Soft Reset)"

2. Print the PDF data in a format which this printer supports again.

PDF print range error.

<Cause> The specified print range is incorrect.

Solution Specify the print range correctly, and then print again.

Print data version error.



<Cause> A problem is occurring with the fixing unit of the printer.

Solution 1 Press [] ( : Online) to continue printing. However, the data may not be printed properly.

Solution 2 Print the data again from the printer driver for the printer.

55 SD Card error. <Auto Error Skip>

<Cause> An SD error has occurred.

Solution 1 If [] ( : Online) is pressed, settings that do not use the SD card are activated. However, you cannot print with functions that use the SD card.

Solution 2 Turn OFF the printer, and make sure that the SD card is inserted correctly.

Solution 3 Contact your local dealer for repairs.

56 SD Card error.

<Cause> An SD error has occurred.

Solution 1 Turn the printer OFF, wait for 10 seconds or longer, and then turn it ON again.



Solution 2 Run SD card quick format or standard format.

Solution 3 Contact your local dealer for repairs.

Set below paper.

<Cause 1> The paper of the size specified in the application is not loaded in the paper drawer or multi-purpose tray, or the paper source for the different paper size is selected.

Solution 1 Load the paper of the size selected in the application (or the one specified by scaling factors).
➤ ["Paper Loading and Output"](#)

Solution 2 Press [] ( : Online), and then print to the currently loaded paper forcibly. If you are using the multi-purpose tray, the setting for [MP Tray Paper Size] in the [Select Feeder] menu automatically changes to the paper size specified in the application.

<Cause 2> The paper size specified in the application software is different from the following setting.

- [MP Tray Paper Size], [Drawer 1 Size] or [Drawer 2 Size] in the [Select Feeder] menu



Solution Specify the setting properly.

<Cause 3> Improper paper source is selected.

Solution	Specify the setting for [Paper Source] in the [Select Feeder] menu properly. ➤ "[Select Feeder] Menu"
	IMPORTANT When the message <Set below paper.> appears If the front cover is opened, the message may disappear. However, be sure to follow the directions in the displayed message to change the paper.



Set cleaning paper and press the Online key. <Auto Error Skip>

<Cause> The printer is waiting to print cleaning paper.

Solution	Load Letter size or A4 paper in the multi-purpose tray, and then press [] ( : Online).
-----------------	---

Syntax error.

<Cause> Invalid data is sent when printing using the UFR II printer driver.



Solution 1	Press [] ( : Online) to continue printing from the next data. However, the page with which an error is occurring and its subsequent pages are not printed.
Solution 2	Confirm the data to be printed, and then print again.

XPS document data error. <Auto Error Skip> (LBP6680x only)

<Cause 1> The XPS data or the data extracted from the XPS data are invalid.

Solution	Check to make sure that the data that was input is normal, restart it and print again.
-----------------	--

<Cause 2> A high volume file was sent directly.

Solution 1	Press [] ( : Online) to cancel the job. Afterward, perform the following processes (decreasing the size of the XPS file), and then print again. <ul style="list-style-type: none">• Optimizing the XPS file• Dividing the XPS file into multiple files
Solution 2	Send the file again using one of the following methods. <ul style="list-style-type: none">• Insert the SD card into the slot and send the file again.• Send the file directly from the USB memory device. ➤ "Installing SD Card (LBP6680x Only)" ➤ "Printing Files Directly from USB Memory Devices (USB Direct Print) (LBP6680x Only)"

XPS font data error. <Auto Error Skip>

<Cause> Incorrect font data was received.

Solution	Check the output result for missing text, and correct the data.
-----------------	---

XPS image data error. <Auto Error Skip>

<Cause> Incorrect image data was received.

Solution Check the output result for missing images, and correct the data.

XPS page data error. <Auto Error Skip>

<Cause> Pages cannot be generated because the description is invalid.

Solution Check the output result for missing pages, and correct the data.

XPS print range error. <Auto Error Skip>

<Cause> The specified print page range is invalid.

Solution Check the page range, and print again.

XPS rendering error.

<Cause> An error has occurred in the XPS data rendering system.

Solution Contact your local dealer.

XPS unsupported image error. <Auto Error Skip>

<Cause> Unsupported images such as HD Photo images are included in the XPS data.

Solution Change the images in the XPS file to TIFF or JPEG format.

A4 nn Error ("nn" represents two-digit alphanumeric characters.)

<Cause> A problem is occurring and the printer does not operate properly.

Solution Cycle the power of the printer. If the message appears even after cycling the power of the printer, note down the message in the display, and contact your local authorized Canon dealer.

A5 nn Error ("nn" represents two-digit alphanumeric characters.)

<Cause> A problem is occurring and the printer does not operate properly.

Solution Cycle the power of the printer. If the message appears even after cycling the power of the printer, note down the message in the display, and contact your local authorized Canon dealer.

A7 nn ERROR ("nn" represents two-digit alphanumeric characters.)

<Cause> A problem is occurring and the printer does not operate properly.

Solution Cycle the power of the printer. If the message appears even after cycling the power of the printer, note down the message in the display, and contact your local authorized Canon dealer.

D7 nn Error ("nn" represents two-digit alphanumeric characters.)

<Cause> A problem is occurring and the printer does not operate properly.

Solution

Cycle the power of the printer. If the message appears even after cycling the power of the printer, note down the message in the display, and contact your local authorized Canon dealer.

D8 nn Error ("nn" represents two-digit alphanumeric characters.)

<Cause> A problem is occurring and the printer does not operate properly.

Solution

Cycle the power of the printer. If the message appears even after cycling the power of the printer, note down the message in the display, and contact your local authorized Canon dealer.

D9 nn Error ("nn" represents two-digit alphanumeric characters.)

<Cause> A problem is occurring and the printer does not operate properly.

Solution

Cycle the power of the printer. If the message appears even after cycling the power of the printer, note down the message in the display, and contact your local authorized Canon dealer.



Paper curls or creases.

- ❖ Paper Curls
- ❖ Paper Creases



Streaks (lines) appear.

- ❖ White Streaks (Lines) Appear



Unevenness or smudge marks appear.

- ❖ Printing Is Uneven
- ❖ Printed Pages Have White Specks
- ❖ Toner Stain or Toner Peeling Occurs
- ❖ The Printed Paper Has Smudge Marks
- ❖ The Printed Paper Has Vertical Streaks
- ❖ Smudge Marks of Spattering Toner Appear around the Text or Patterns
- ❖ The Back of the Printed Paper Has Smudge Marks
- ❖ The Overall Print Result Is Dark
- ❖ Residual Images Appear on Non-printed Areas
- ❖ White Dust Is Attached to the Printed Transparencies



Printing is faint or faded.

- ❖ The Overall Print Result Is Faint



Printout is skewed, missing, or has unneeded space.

- ❖ The Printing Position Is Skewed
- ❖ A Portion of the Page Is Not Printed
- ❖ Data Is Reduced and Printed
- ❖ The Next Page Is Printed from Halfway across the Previous Page
- ❖ Printed Data Lies outside Paper



Others

- ❖ Blank Paper Is Output (Nothing Is Printed on the Paper)
- ❖ The Overall Surface of the Paper Is Printed in Black Completely
- ❖ The Last Page Cannot Be Printed
- ❖ Unreadable Characters Are Printed
- ❖

- The Printout Is Different from What Is Displayed on Screen (Windows 2000, XP, and Server 2003)
- ❖ The Flap of the Printed Envelope Sticks
 - ❖ Multiple Sheets of Paper Are Fed at a Time

 **NOTE**

Contacting your local authorized Canon dealer

If a problem that is not indicated in the e-Manual occurs, if none of the suggested measures solve the problem, or if you cannot determine the problem, contact your local authorized Canon dealer.



Perform one of the following solutions according to the cause.

<Cause 1> Damp paper is used.

Solution 1	Replace the paper with new paper in an unopened package. ➤ "Precautions for Paper"
Solution 2	Perform the following procedure in the printer driver when you are using plain paper (60 to 90 g/m ²). <ol style="list-style-type: none">1. Display the [Paper Source] sheet.2. Set [Paper Type] to [Plain L].
Solution 3	Perform the following procedure in the printer driver when you are using plain paper (60 to 90 g/m ²). <ol style="list-style-type: none">1. Display the [Finishing] sheet.2. Click [Advanced Settings].3. Set [Special Print Mode [Plain Paper]] to [Mode 1]. <p style="text-align: center;">▼</p> <p style="text-align: center;">If the problem is not solved, specify [Mode 2].</p> You can specify the same setting from the printer's control panel. ➤ "[Setup] Menu ([User Maintenance] Options)" <ul style="list-style-type: none">† If [Plain Ppr. Curl Corr] is set to [Mode 1] or [Mode 2], the toner may not fix onto paper well, and the printing may come out faint.† Normally, use the printer with [Plain Ppr. Curl Corr] set to [Off]. Specify [Mode 1] or [Mode 2] only if the described problems occur.† If you specify [Mode 1], printing speed drops.† If you specify [Mode 2], printing speed drops compared to when specifying [Mode 1].

<Cause 2> Appropriate paper is not being used.

Solution	Replace the paper with that which can be used with this printer. ➤ "Usable Paper"
-----------------	--

<Cause 3> Paper that curls easily is output to the output tray.

Solution	Switch to the sub-output tray when printing transparencies, labels, or envelopes. ➤ "Paper Loading and Output"
-----------------	---



Perform one of the following solutions according to the cause.

<Cause 1> Paper is not loaded properly in the paper drawer or multi-purpose tray.

Solution

Load the paper properly.

- ❖ "Loading Paper in the Paper Drawer"
- ❖ "Loading Paper in the Multi-purpose Tray"

<Cause 2> Damp paper is used.

Solution

Replace the paper with new paper in an unopened package.

- ❖ "Precautions for Paper"

<Cause 3> Appropriate paper is not being used.

Solution

Replace the paper with that which can be used with this printer.

- ❖ "Usable Paper"

<Cause 4> There is a foreign object inside the printer.

Solution

Remove the foreign object inside the printer.

White Streaks (Lines) Appear

04L9-0KE



Perform one of the following solutions according to the cause.

<Cause 1> The toner cartridge is almost out of toner.

Solution

Take the toner cartridge out of the printer, shake it gently five or six times to evenly distribute the toner, and then reinstall the toner cartridge.

➤ ["Toner Cartridge Replacement"](#)

<Cause 2> The drum in the toner cartridge is deteriorated.

Solution

Replace the toner cartridge with a new one.

➤ ["Toner Cartridge Replacement"](#)

Printing Is Uneven

04L9-0KF



Perform one of the following solutions according to the cause.

<Cause 1> Paper is too moist or too dry.

Solution

Replace the paper with new paper in an unopened package.
➤ ["Precautions for Paper"](#)

<Cause 2> The toner cartridge is almost out of toner.

Solution

Take the toner cartridge out of the printer, shake it gently five or six times to evenly distribute the toner, and then reinstall the toner cartridge.
➤ ["Toner Cartridge Replacement"](#)

<Cause 3> The drum in the toner cartridge is deteriorated.

Solution

Replace the toner cartridge with a new one.
➤ ["Toner Cartridge Replacement"](#)

Printed Pages Have White Specks

04L9-0KH



Perform one of the following solutions according to the cause.

<Cause 1> Appropriate paper is not being used.

Solution

Replace the paper with that which can be used with this printer.
➤ ["Usable Paper"](#)

<Cause 2> Damp paper is used.

Solution

Replace the paper with new paper in an unopened package.
➤ ["Precautions for Paper"](#)

<Cause 3> The drum in the toner cartridge is deteriorated.

Solution

Replace the toner cartridge with a new one.
➤ ["Toner Cartridge Replacement"](#)

Toner Stain or Toner Peeling Occurs

04L9-0KK



Perform one of the following solutions according to the cause.

<Cause 1> The setting for [Paper Type] is not specified properly.

Solution

Specify [Paper Type] properly.
➤ ["Configuring the Printer Driver and Printing"](#)

<Cause 2> Appropriate paper is not being used.

Solution

Replace the paper with that which can be used with this printer.
➤ ["Usable Paper"](#)

<Cause 3> A problem is occurring inside the printer.

Solution

If <Ennn-nnnn> appears in the display, follow the procedure in ["The Message Indicator Is On"](#) to solve the problem.

The Printed Paper Has Smudge Marks

04L9-0KL



Perform the following procedure.

<Cause>The fixing roller is dirty.

Solution

Clean the fixing roller.
➤ ["Cleaning the Fixing Roller of the Printer"](#)

The Printed Paper Has Vertical Streaks

04L9-0RR



Perform one of the following solutions according to the cause.

<Cause 1> Depending on the paper type or the operating environment, vertical streaks may appear on the printed paper.

Solution 1	Replace the paper with new paper in an unopened package. ❖ "Precautions for Paper"
Solution 2	Perform the following procedure in the printer driver. <ol style="list-style-type: none">1. Display the [Finishing] sheet.2. Click [Advanced Settings].3. Set [Special Print Adjustment A] to [Mode 2]. <p style="text-align: center;">▼</p> <p>If the problem is not solved, specify [Mode 3].</p> <p style="text-align: center;">▼</p> <p>If the problem is not solved, specify [Mode 4].</p> <p>You can specify the same setting from the printer's control panel. ❖ "[Setup] Menu ([User Maintenance] Options)"</p> <p>† Resetting the setting to [Mode 1] due to change in paper type or operating environment may also avoid vertical streaks appearing on the printed paper. In this case, reset the setting to [Mode 1].</p> <p>† Vertical streaks are alleviated by specifying a setting between [Mode 2] and [Mode 4]. However, this decreases print density compared to when [Mode 1] is specified. This may also make outlines appear to be blurred or slightly jagged.</p>

<Cause 2> The toner cartridge was replaced, or the printer was not printed for a long period of time.

Solution	Perform the following procedure in the printer driver. <ol style="list-style-type: none">1. Display the [Finishing] sheet.2. Click [Advanced Settings].3. Set [Special Print Adjustment B] to [Mode 1]. <p style="text-align: center;">▼</p> <p>If the problem is not solved, specify [Mode 2].</p> <p style="text-align: center;">▼</p> <p>If the problem is not solved, specify [Mode 3].</p>
-----------------	--

- † Selecting [Off] may also avoid vertical streaks appearing on the printed paper. In this case, reset the setting to [Off].
 - † If [Special Print Adjustment B] is specified, printing speed may slow.
-

Smudge Marks of Spattering Toner Appear around the Text or Patterns

04L9-0KR



Perform the following procedure.

<Cause> Appropriate paper is not being used.

Solution

Replace the paper with that which can be used with this printer.
➤ "Usable Paper"

The Back of the Printed Paper Has Smudge Marks

04L9-0KS



Perform the following procedure.

<Cause> The size of the print data was larger than that of the loaded paper.

Solution Check if the size of the print data matches that of the loaded paper.

The Overall Print Result Is Dark

04L9-0KU



Perform one of the following solutions according to the cause.

<Cause 1> The setting for [Density] is not appropriate.

Solution

Adjust [Density].
❖ "[Setup] Menu ([Quality] Options)"

<Cause 2> The printer is exposed to direct sunlight or strong light.

Solution

Move the printer.
❖ "Moving the Printer"

Residual Images Appear on Non-printed Areas

04L9-0KW



Perform one of the following solutions according to the cause.

<Cause 1> Appropriate paper is not being used.

Solution

Replace the paper with that which can be used with this printer.
➤ ["Usable Paper"](#)

<Cause 2> The drum in the toner cartridge is deteriorated.

Solution

Replace the toner cartridge with a new one.
➤ ["Toner Cartridge Replacement"](#)

White Dust Is Attached to the Printed Transparencies

04L9-0KX

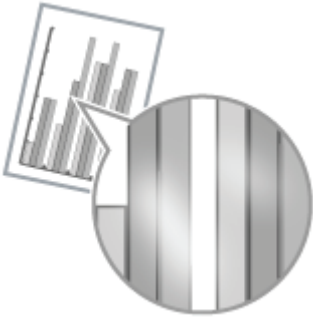

Perform the following procedure.

<Cause> You print transparencies after printing paper other than transparency continuously.

Solution Wipe and remove the chipped paper with a soft cloth.

The Overall Print Result Is Faint

04L9-0KY



Perform one of the following solutions according to the cause.

<Cause 1> The setting for the toner density is not appropriate.

Solution

Adjust the toner density for printing to a darker setting.
❖ "[Setup] Menu ([Quality] Options)"

<Cause 2> [Toner Save] is enabled.

Solution

- **UFR II Printer Driver**

Perform the following procedure in the printer driver.

1. Display the [Quality] sheet.
2. Click [Advanced Settings].
3. Set [Toner Save] to [Off].

- **PCL/PS Printer Driver**

See Help of the PCL/PS printer driver.

You can specify the same setting from the printer's control panel.

❖ "[Setup] Menu ([Quality] Options)"

The Printing Position Is Skewed

04L9-0LE



Perform one of the following solutions according to the cause.

<Cause 1> [Gutter] is specified.

Solution

Perform the following procedure in the printer driver.

1. Display the [Finishing] sheet.
2. Click [Gutter].
3. Set [Gutter] to "0."

You can specify the same setting from the printer's control panel.

➤ "[Setup] Menu ([Layout] Options)"

<Cause 2> [Offset Y] and [Offset X] are specified.

Solution

Set [Offset Y] and [Offset X] to "0."

➤ "Adjusting the Printing Position for All the Jobs"

<Cause 3> "Top Margin" and "Paper Position" in the application are not specified properly.

Solution

Specify the settings for "Top Margin" and "Paper Position" in the application properly. See the instruction manual supplied with the application.

<Cause 4> The printing position is adjusted in [Adj. Start Position].

Solution

Adjust the printing position to an appropriate value in [Adj. Start Position].

➤ "Adjusting the Printing Position for Each Paper Source"

A Portion of the Page Is Not Printed

04L9-0LH



Perform one of the following solutions according to the cause.

<Cause 1> The setting for the scaling factor is not appropriate.

Solution 1	<p>Perform the following procedure in the printer driver.</p> <ol style="list-style-type: none">1. Display the [Page Setup] sheet.2. Clear the [Manual Scaling] check box. <p>† If the [Manual Scaling] check box is cleared, the scale factor will be set according to [Page Size] and [Output Size] automatically.</p>
Solution 2	<p>Perform the following procedure in the printer driver.</p> <ol style="list-style-type: none">1. Display the [Page Setup] sheet.2. Select the [Manual Scaling] check box, and then specify an appropriate scale factor according to the paper size to be used.

<Cause 2> Paper is not loaded properly in the paper drawer or multi-purpose tray.

Solution	<p>Load the paper properly.</p> <ul style="list-style-type: none">❖ "Loading Paper in the Paper Drawer"❖ "Loading Paper in the Multi-purpose Tray"
-----------------	---

<Cause 3> A document with no margins was printed.

Solution 1	<p>Data is printed with a margin of 5 mm (10 mm for envelopes). Provide a margin around the data.</p> <ul style="list-style-type: none">❖ "Printable Area"
Solution 2	<p>Perform the following procedure if you are using the printer driver.</p> <p>PCL/UFR II Printer Driver</p> <ol style="list-style-type: none">1. Display the [Finishing] sheet.2. Click [Advanced Settings].3. Set [Expand Print Region and Print] to [On]. <p>PS Printer Driver</p> <p>See Help of the PS printer driver.</p> <p>† The edges of the printout may be partly missing, depending on the settings of the document to be printed.</p>

Data Is Reduced and Printed

04L9-0LJ



Perform the following procedure.

<Cause> The setting for the scaling factor is not appropriate.

Solution 1

Perform the following procedure in the printer driver.

1. Display the [Page Setup] sheet.
2. Clear the [Manual Scaling] check box.

† If the [Manual Scaling] check box is cleared, the scale factor will be set according to [Page Size] and [Output Size] automatically.

Solution 2

Perform the following procedure in the printer driver.

1. Display the [Page Setup] sheet.
2. Select the [Manual Scaling] check box, and then specify an appropriate scale factor according to the paper size to be used.

The Next Page Is Printed from Halfway across the Previous Page

04L9-OLK

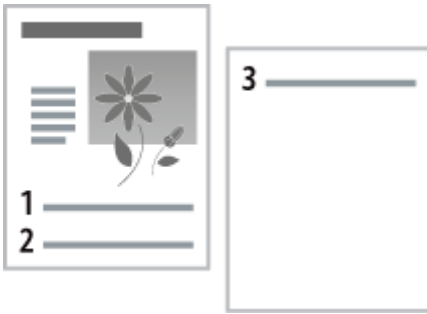

Perform one of the following solutions according to the cause.

<Cause 1> "Line Spacing" or "Lines/Page" in the application is not specified properly.

Solution

Specify the settings for "Line Spacing" or "Lines/Page" in the application so that the data fits in one page, and then print again.
See the instruction manual supplied with the application.

<Cause 2> When [Auto Mode Selection] is set to [Auto Selection], the number of seconds specified in [Timeout Time] is too short.

Solution

Set [Auto Mode Selection] to a setting other than [Auto Selection], or increase the number of seconds specified in [Timeout Time] sufficiently.

- ❖ "[Setup] Menu ([Print Mode] Options)"
- ❖ "[Setup] Menu ([Interface] Options)"

Printed Data Lies outside Paper

04L9-0LL

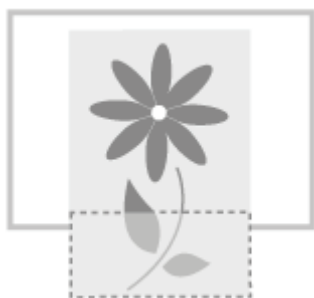

Perform one of the following solutions according to the cause.

<Cause 1> When the following settings in the [Select Feeder] menu are set to [Mixed Sizes], custom size paper whose long edges are 215.9 mm or less is loaded in landscape orientation and printed (only when the UFR II printer driver is used).

- Size of the paper in the multi-purpose tray
- Drawer N (N = 1, 2) size

Solution Load the paper in portrait orientation, and then print again.

<Cause 2> When the UFR II printer driver was not used, custom size paper was loaded in portrait orientation to be printed.

Solution Load the paper in landscape orientation, and then print again.

<Cause 3> Paper is not loaded properly in the paper drawer or multi-purpose tray.

Solution Load the paper properly.

- ❖ "Loading Paper in the Paper Drawer"
- ❖ "Loading Paper in the Multi-purpose Tray"

<Cause 4> The printing position is adjusted in [Adj. Start Position].

Solution The printing position is adjusted in [Adj. Start Position].

- ❖ "Adjusting the Printing Position for Each Paper Source"

Blank Paper Is Output (Nothing Is Printed on the Paper)

04L9-OLR



Perform one of the following solutions according to the cause.

<Cause 1> The toner cartridge was installed with the sealing tape still attached.

Solution

Take the toner cartridge out of the printer, pull out the sealing tape, and reinstall the toner cartridge.
➤ ["Toner Cartridge Replacement"](#)

<Cause 2> Multiple sheets of paper are fed at a time.

Solution

Fan the paper thoroughly, and then align the edges of the stack properly on a hard, flat surface.

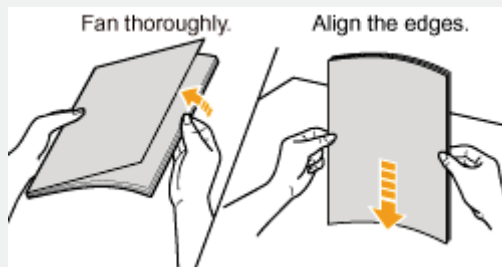

<Cause 3> The size of the paper loaded in a paper source is different from the following settings.

- Setting for [Output Size] in the [Page Setup] sheet in the printer driver
- [MP Tray Paper Size], [Drawer 1 Size], or [Drawer 2 Size] in the [Select Feeder] menu

Solution

When the message <Check Paper Size> appears in the display, perform the described solutions in "[A Message Appears in the Control Panel.](#)"

The Overall Surface of the Paper Is Printed in Black Completely

04L9-0LS



Perform one of the following solutions according to the cause.

<Cause 1> The drum in any of the toner cartridges has deteriorated or is damaged.

Solution

Replace the toner cartridge with a new one.
➤ ["Toner Cartridge Replacement"](#)

<Cause 2> A problem is occurring inside the printer.

Solution

If <Ennn-nnnn> appears in the display, follow the procedure in "The Service Call <Ennn-nnnn> Appears in the Display ("n" Represents an Alphanumeric Character)" in "[The Message Indicator Is On](#)" to solve the problem.



The Last Page Cannot Be Printed

04L9-0LU

Perform the following procedure.

<Cause> The command that notifies of the end of the data is not sent from the computer. (The (Job) indicator is on.)

Solution

Press [] ( : Online) to place the printer offline, and then select [Form Feed] in the Reset menu.

➤ "Outputting Data (Forced Output)"

- † If you print using an application that does not have a printing function, [Form Feed] is performed because the last page in which data is less than one page remains in the memory.

Unreadable Characters Are Printed

04L9-0LW



Perform one of the following solutions according to the cause.

<Cause 1> The data is printed from Windows without the supplied printer driver installed for Windows.

Solution

Install the supplied printer driver for Windows, and then print again.
For details on the procedure for installing the printer driver, see "Printer Driver Installation Guide."

<Cause 2> The printer setting in the DOS application is not appropriate.

Solution

Specify the printer setting in the DOS application to the one that is compatible with this printer.

The Printout Is Different from What Is Displayed on Screen (Windows 2000, XP, and Server 2003)

04L9-0LX

Perform the following procedure.

<Cause> This problem may occur in some applications depending on the processing type of the print data.

Solution

If you are using the PCL/UFR II printer driver, performing the following procedure may be able to solve the problem.

1. Display the [Finishing] sheet.
2. Click [Advanced Settings].
3. Change the [EMF Spooling] setting.

The Flap of the Printed Envelope Sticks

04L9-0LY

Perform the following procedure.

<Cause> The envelope is inappropriate.

Solution

Replace the envelope with that which can be used with this printer.
➤ "Usable Paper"

Multiple Sheets of Paper Are Fed at a Time

04L9-0R0

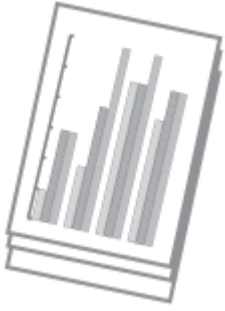

Perform the following procedure.

<Cause> You are using paper which tends to be fed at a time.

Solution

Fan the paper thoroughly, and then align the edges of the stack properly on a hard, flat surface.

A diagram illustrating the solution in two steps. The first step, labeled 'Fan thoroughly.', shows a pair of hands holding a stack of paper, with one hand lifting the top sheet to fan the stack. An orange arrow points to the right, indicating the direction of the fan. The second step, labeled 'Align the edges.', shows a pair of hands holding the stack vertically, with one hand adjusting the edges. An orange arrow points downwards, indicating the direction of alignment.

➤ **The Keys on the Control Panel Do Not Function**

➤ **The SD Card Cannot Be Used**

➤ **Jobs Cannot Be Saved**

➤ **SSL Cannot Be Enabled**

➤ **When SSL Is Enabled, the Remote UI Does Not Start, or the IPP Printing Cannot Be Performed**

➤ **The Printer Cannot Be Accessed from the Remote UI or Network Related Utility Software**

➤ **Restricting the Users Is Not Possible**

➤ **Noise Is Heard during Printing**



The Keys on the Control Panel Do Not Function

04L9-0R3

Perform one of the following solutions according to the cause.

<Cause 1 > Here is data remaining in the memory. (The (Job) indicator is on.)

Solution

Press [] ( : Online) to place the printer offline, and then select [Form Feed] in the Reset menu.
▶ "Outputting Data (Forced Output)"

<Cause 2> The keylock function is enabled. (The "Pi" alarm sounds when the key is pressed and <Key locked.> appears in the display.)

Solution

Disable the keylock function from the Remote UI. Contact the printer administrator.

The SD Card Cannot Be Used

04L9-0R4

Perform one of the following solutions according to the cause.

<Cause 1> [SD Card] in the Control Menu options in the Setup menu is set to [Off].

Solution

Set [SD Card] to [On], and then perform a hard reset.

- ❖ [Setup] Menu ([Control Menu] Options)
- ❖ Canceling All the Jobs (Hard Reset)

<Cause 2> An error has occurred in the SD card.

Solution

Perform formatting in [SD Card Maintenance] in the User Maintenance options in the Setup menu. If the same error still occurs, replace the SD card.

- ❖ [Setup] Menu ([User Maintenance] Options)
- ❖ Installing SD Card (LBP6680x Only)

<Cause 3> The SD card is not installed properly.

Solution

Turn the printer OFF, and then check if the SD card is installed properly.

- ❖ "Installing SD Card (LBP6680x Only)"

<Cause 4> The data cannot be saved on the SD card because there is not sufficient free space in the SD card.

Solution

Delete any unnecessary jobs from among the jobs saved on the SD card.

- ❖ "Saving a Document in the SD Card in the Printer (Stored Job Print) (LBP6680x Only)"
- ❖ "Remote UI"

<Cause 5> The SD card is write-protected.

Solution

Check that the SD card is not write-protected. If the card is write-protected, release the protection, and then insert the card.

Jobs Cannot Be Saved

04L9-0R5

Perform one of the following solutions according to the cause.

<Cause 1> The data cannot be saved on the SD card because there is not sufficient free space in the SD card.

Solution 1	The data cannot be saved on the SD card because there is not sufficient free space in the SD card. The printer is ready to print by pressing [] (↔ : Online), ignoring the print data. The data of 3 GB or larger in total cannot be saved.
Solution 2	Delete any unnecessary jobs from among the jobs saved on the SD card. ❖ "Saving a Document in the SD Card in the Printer (Stored Job Print) (LBP6680x Only)" ❖ "Remote UI"

<Cause 2> The number of the jobs exceeded the number of jobs you can save in the SD card.

Solution 1	The printer is ready to print by pressing [] (↔ : Online), ignoring the print data. Up to 100 jobs can be saved all together.
Solution 2	Delete any unnecessary jobs from among the jobs saved on the SD card. ❖ "Saving a Document in the SD Card in the Printer (Stored Job Print) (LBP6680x Only)" ❖ "Remote UI"

SSL Cannot Be Enabled

04L9-0R6

Perform the following procedure.

<Cause> The key pair and its certificate to be used are not registered.

Solution

Register the key pair and server certificate that are used.

➤ ["Setting Keys and Certificates"](#)

† In order to use the SSL encryption communication function, it is necessary to create keys and certificates and to register the key pair and server certificate that are used.

When SSL Is Enabled, the Remote UI Does Not Start, or the IPP Printing Cannot Be Performed

04L9-0R7

Perform the following procedure.

<Cause> The file related to key management is broken.

Solution

Perform the following procedure.

1. Select [Network] → [Remote UI Settings] → [SSL] using the control panel, and then make sure that [SSL] is set to [Off].
2. Restart the printer.
3. Regenerate the key and certificate and specify the settings for SSL from the Remote UI.
 - ["Setting Keys and Certificates"](#)
4. Restart the printer.

The Printer Cannot Be Accessed from the Remote UI or Network Related Utility Software

04L9-056

Perform the following procedure.

<Cause> The IP Address Filter or MAC Address Filter is set to On.

Solution

Select [Network] → [Address Filter] using the control panel, and then make sure that [Address Filter] is set to [Off].

➤ "[Setup] Menu ([Network] Options)"

- † If you have once set it to [Off], set it back to [On] after confirmation of the setting.
- † Use the control panel to make a setting for the address filter function.

Restricting the Users Is Not Possible

04L9-057

Perform the following procedure.

<Cause> The IP Address Filter or MAC Address Filter is not set to On.

Solution

Select [Network] → [Address Filter] using the control panel, and then make sure that [Address Filter] is set to [On].

➤ "[Setup] Menu ([Network] Options)"

↑ Use the control panel to make a setting for the address filter function.

Noise Is Heard during Printing

04L9-0RS

Perform the following procedure.

<Cause> This printer may produce noise when transporting Plain or Plain L size paper during printing.

Solution

Perform the following procedure.

1. Select [Plain Ppr. Curl Corr] in [User Maintenance].
2. Set [Mode 1] or [Mode 2].

† Selecting [Mode 1] or [Mode 2] decreases the printing speed. If the noise does not disturb you, we recommend that you select [Off].

If You Cannot Solve a Problem

04L9-0RU

If you cannot solve the problem after having referred to the information in this chapter, contact your local authorized Canon dealer or the Canon help line.

Please have the following information ready when contacting the Canon:

- Product name (LBP6680x/LBP6670dn)
- Serial number (see the following illustrations to find the location of the serial number.)

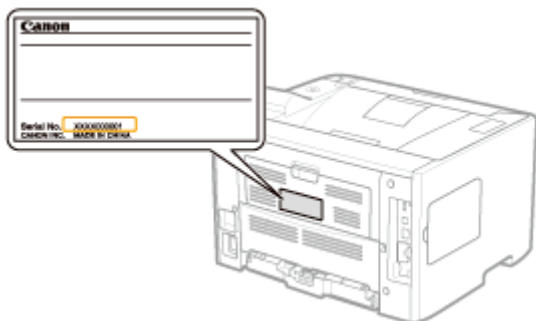

- Place of purchase
- Nature of the problem
- Steps you have taken to solve the problem and the results

WARNING

If the machine makes strange noises or emits smoke or an odd odor

Turn OFF the power switch immediately, disconnect the power cord, and contact the Canon Customer Care Center. Do not attempt to disassemble or repair the machine yourself.

IMPORTANT

If you attempt to repair the machine by yourself

It may void the limited warranty.

➤ **Basic Operations/Various Information for Windows**

➤ **For Windows 8/Server 2012 Users**

➤ **The Lists Common to All the Settings in the Print Mode**

➤ **The Lists Common to Certain Settings in the Print Mode**

➤ **Font Samples**

Basic Operations/Various Information for Windows

04L9-0R9

- ❖ Displaying the Top Page of the User Manual CD-ROM
- ❖ Checking the IP Address Using the PING Command
- ❖ Checking the Processor Version of Windows Vista, 7, or Server 2008
- ❖ Printing a Test Page in Windows
- ❖ Checking the Bi-directional Communication
- ❖ Displaying the Printer Folder
- ❖ Checking Printers in the Print Server
- ❖ Checking the Port
- ❖ Changing the Printing Protocol
- ❖ Setting for [Device Type] when Setting a Port

Displaying the Top Page of the User Manual CD-ROM

If the top page of the User Manual CD-ROM does not appear even after inserting the CD-ROM, perform the following procedure.

- † The CD-ROM drive name is indicated as "D:" in this manual. The CD-ROM drive name may differ depending on the computer you are using.

Windows 2000 Windows XP Windows Server 2003

1. From the [Start] menu, select [Run].
2. Enter "D:\Maninst.exe."

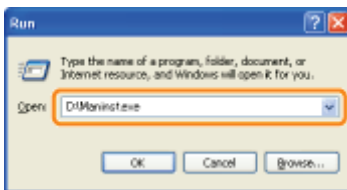

3. Click [OK].

Windows Vista Windows 7 Windows Server 2008

1. Enter "D:\Maninst.exe" in [Search programs and files] or [Start Search] under the [Start] menu.



2. Press the [ENTER] key on the keyboard.

Checking the IP Address Using the PING Command

1

Run Command Prompt.

From the [Start] menu, select [All Programs] or [Programs] → [Accessories] → [Command Prompt].

2

Enter "ping <the IP address of the printer>", and then press the [ENTER] key on your keyboard.

- **Input example:** "ping 192.168.0.215"

- † Correctly enter the IP address which is set for the printer. If the wrong IP address is entered, you cannot obtain an

appropriate check result.

3

Check the displayed result.

- **When "Packets: Sent = 4, Received = 4, Lost = 0 (0% loss)," is displayed**
The IP address is set properly.
- **When "Packets: Sent = 4, Received = 0, Lost = 4 (100% loss)," is displayed**
Ask your network administrator about the problem.

4

Enter "exit", and then press [ENTER] on the keyboard to exit Command Prompt.

NOTE

When using DHCP, BOOTP, or RARP

Consult your network administrator and perform either of the following settings.

- Set the DNS Dynamic Update function.
["Configuring the Protocol Settings"](#)
- Configure DHCP or other settings so that the same IP address is always assigned to the printer when the printer is started.
["Configuring the Protocol Settings"](#)

Checking and configuring the subnet

Enter "ipconfig" as a command in Command Prompt.

The network setting information of the computer appears. Confirm that the computer and printer are on the same subnet.

- **Example:**

Setting in a computer

- Subnet mask: "255.255.255.0" ▶ The IP address of the printer needs to be "192.168.0.xxx". (xxx indicates an arbitrary number.)
- IP Address: "192.168.0.10"

Checking the Processor Version of Windows Vista, 7, or Server 2008

If you are not sure whether you are using 32-bit Windows Vista/7/Server 2008 or 64-bit Windows Vista/7/Server 2008, you can check that using the following procedure.

1

From the [Start] menu, select [Control Panel].

2

Display [System].

Windows Vista **Windows 7** **Windows Server 2008 R2**

Click [System and Security] or [System and Maintenance] → [System].

Windows Server 2008

Double-click [System].

3

Check the processor version.

For a 32-bit operating system

[32-bit Operating System] is displayed.

For a 64-bit operating system

[64-bit Operating System] is displayed.

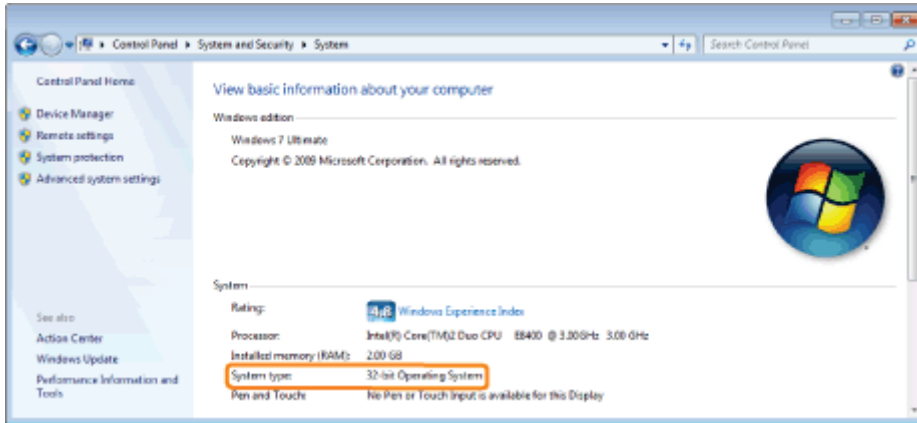

Printing a Test Page in Windows

You can check the operations of the printer driver by printing a test page in Windows.

1

Load A4 paper in the multi-purpose tray or paper drawer.

❏ "Paper Loading and Output"

2

Open the printer folder.

❏ "Displaying the Printer Folder"

3

Right-click the icon for this printer, and then select [Printer properties] or [Properties] from the pop-up menu.

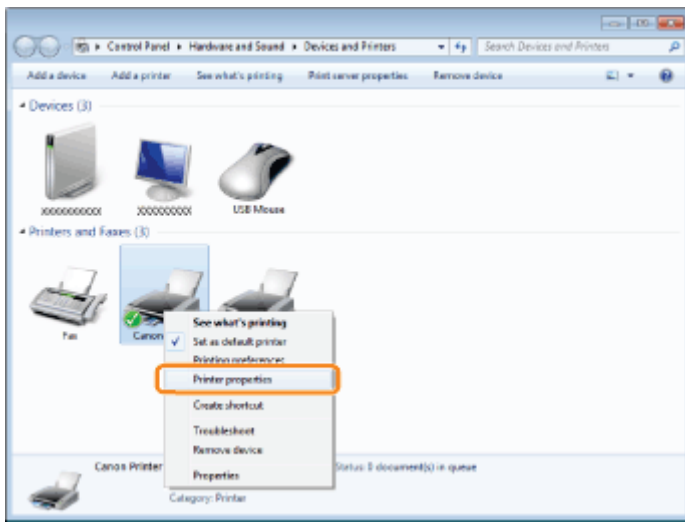

4

Print a test page.

- (1) Display the [General] sheet.
- (2) Click [Print Test Page] to print a test page.

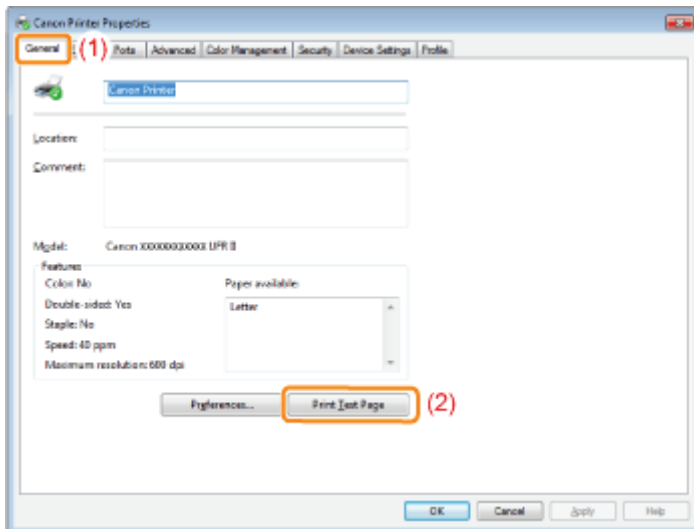

Checking the Bi-directional Communication

1

Open the printer folder.

- ❖ "Displaying the Printer Folder"

2

Right-click the icon for this printer, and then select [Printer properties] or [Properties] from the pop-up menu.

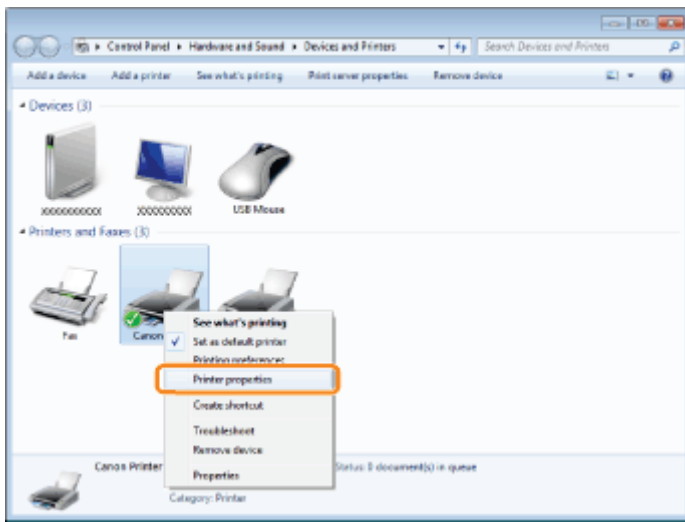

3

Check the bi-directional communication.

- (1) Display the [Ports] sheet.
- (2) Check the [Enable bidirectional support] check box is selected.

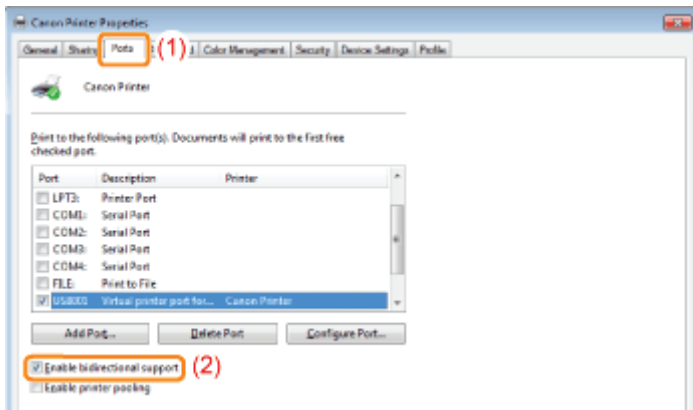

IMPORTANT

Do not clear the [Enable bidirectional support] check box.

If the check box is cleared, you cannot perform printing.

Displaying the Printer Folder

Windows 2000

From the [Start] menu, select [Settings] → [Printers].

Windows XP Professional Windows Server 2003

From the [Start] menu, select [Printers and Faxes].

Windows XP Home Edition

From the [Start] menu, select [Control Panel], and then click [Printers and Other Hardware] → [Printers and Faxes].

Windows Vista

From the [Start] menu, select [Control Panel], and then click [Printer].

Windows 7 Windows Server 2008 R2

From the [Start] menu, select [Devices and Printers].

Windows Server 2008

From the [Start] menu, select [Control Panel], and then double-click [Printers].

Checking Printers in the Print Server

1

Display [Windows Explorer].

From the [Start] menu, select [All Programs] or [Programs] → [Accessories] → [Windows Explorer].

2

Check printers in the print server.

- (1) Select the print server from [Network] or [My Network Places].
- (2) Check the icon for this printer is displayed.

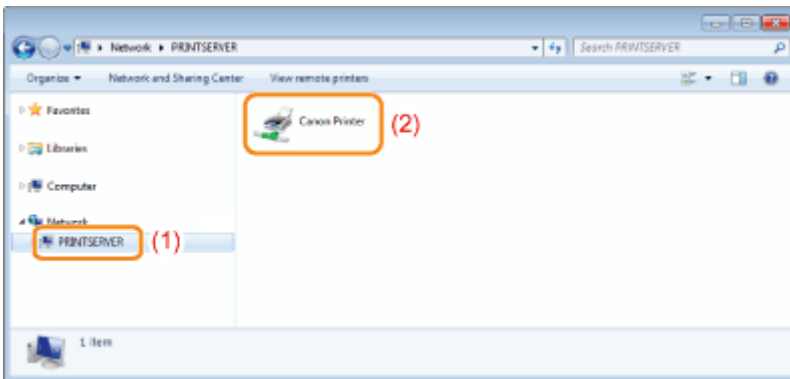

Checking the Port

1

Open the printer folder.

➤ "Displaying the Printer Folder"

2

Right-click the icon for this printer, and then select [Printer properties] or [Properties] from the pop-up menu.

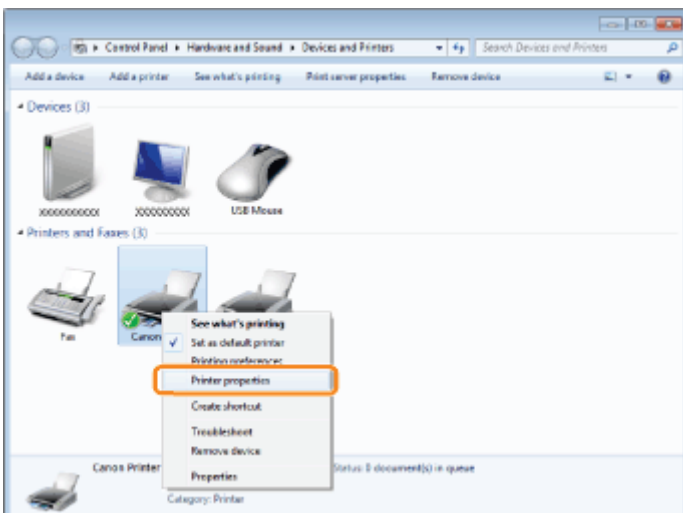

3

Check a port.

- (1) Display the [Ports] sheet.
- (2) Confirm the port is selected properly.

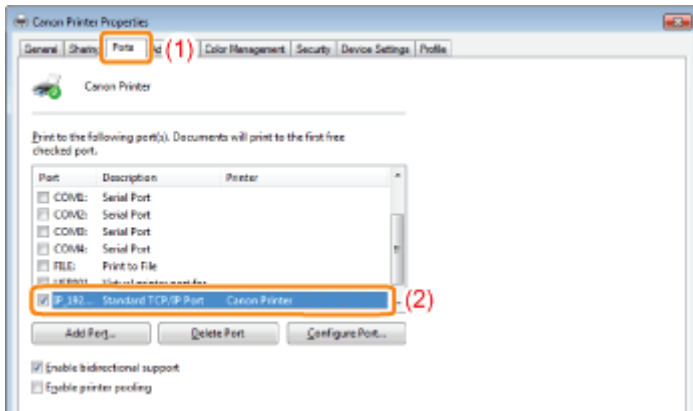

Changing the Printing Protocol

Change the printing protocol to LPR and specify the setting for the LPR byte count using the following procedure.

1

Open the printer folder.

❖ "Displaying the Printer Folder"

2

Right-click the icon for this printer, and then select [Printer properties] or [Properties] from the pop-up menu.

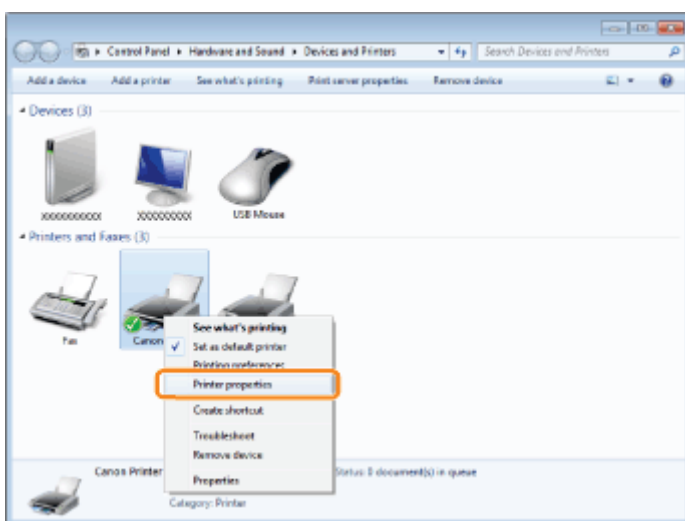

3

Display the [Ports] sheet.

4

Click **[Configure Port]**.

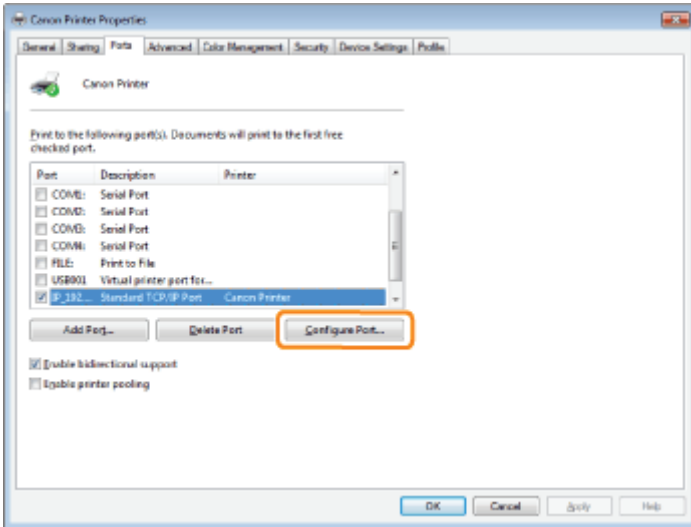

5

Perform the following procedure.

- (1) To change the printing protocol to LPR, select [LPR] for [Protocol].
- (2) To enable the LPR byte count, select the [LPR Byte Counting Enabled] check box.

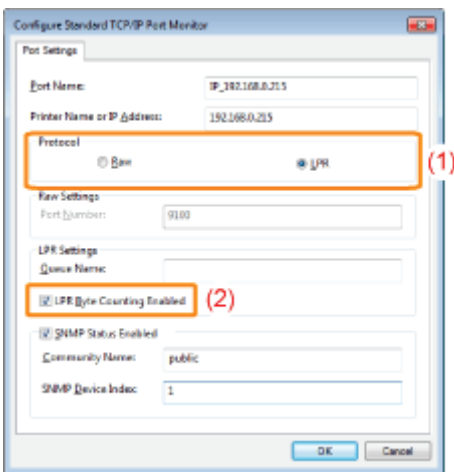

6

Click **[OK]**.

Setting for [Device Type] when Setting a Port

If the printer cannot be detected when setting a port, set [Device Type] as follows.

- (1) Select [Standard], and then select [Canon Network Printing Device with P9100].
- (2) Click [Next].

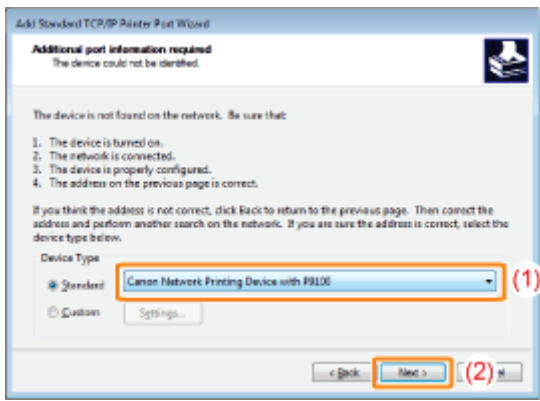

For Windows 8/Server 2012 Users

04L9-0SC

This printer supports Windows 8/Server 2012 operating system. For operation and description on Windows 8/Server 2012, refer to Windows Vista/7 sections. This section describes notes on using this printer with Windows 8/Server 2012. Read this section carefully before using the printer.

Precautions

Use the desktop mode when performing the followings.

- Installing/Uninstalling the printer driver
- Setting the printer driver *

* Please note that the setting specified on the desktop may not be reflected to all Windows Store applications.

For Windows 2000 Users

This printer does not support Windows 2000. For details on the latest status of the supported operating systems and service packs, see the Canon web site (<http://www.canon.com/>).

The Lists Common to All the Settings in the Print Mode

04L9-0RA





- ❖ Configuration Page
- ❖ Network Status Print
- ❖ Printing Position Adjustment Print

IMPORTANT

The following lists are samples. The contents may partially differ from the lists printed by your printer.

Configuration Page





The printer information and the settings for printing environment are printed.

1. Make sure that the printer is online.
2. Press [ / ] ( / ): Utility) to display the [Utility Menu] menu.
3. Select [Configuration Page] using [▲] and [▼], and then press [OK].
4. Select [Yes] using [▼] in the [Execute?] display, and then press [OK] to output the page.



Network Status Print





Prints the version number and the settings of the print server equipped with this printer.

1. Make sure that the printer is online.
2. Press [ / ] ( / ): Utility) to display the [Utility Menu] menu.
3. Select [Network Status Print] using [▲] and [▼], and then press [OK].
4. Select [Yes] using [▼] in the [Execute?] display, and then press [OK] to output the page.



Printing Position Adjustment Print

Displays the current printing positions of each paper source. Adjust the printing positions referring to this print. For more details, see "[Adjusting the Printing Position for Each Paper Source](#)."

1. Press [●] ( : Feeder Selection).
2. Select [Paper Source] using [▲] and [▼], and then press [OK].
3. Select the paper source that you want to check the printing position using [▲] and [▼], and then press [OK].
4. Press [○] ( : Online).
5. Make sure that the printer is online. If the printer is not online, press [○] ( : Online).
6. Press [] ( : Utility) to display [Utility Menu] menu.
7. Select [Printing Pos. Print] using [▲] and [▼], and then press [OK].
8. Select [Yes] using [▼] in the [Execute?] display, and then press [OK] to output the page.

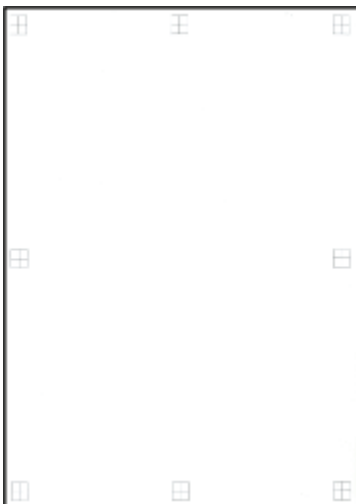

The Lists Common to Certain Settings in the Print Mode

04L9-0RC





- PCL Font List
- PS Configuration Page
- PS Font List

IMPORTANT

The following lists are samples. The contents may partially differ from the lists printed by your printer.

PCL Font List

A list of the fonts that can be used in the PCL mode is printed.



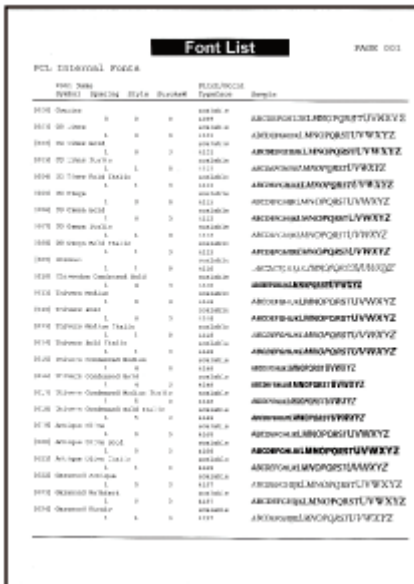

1. Make sure that the printer is online.
2. Press [ / ] ( /  : Utility) to display the [Utility Menu] menu.
3. Select [PCL Utility] using [▲] and [▼], and then press [OK].
4. Select [Font List] using [▲] and [▼], and then press [OK].
5. Select [Yes] using [▼] in the [Execute?] display, and then press [OK] to output the page.



Font Name	Encoding	Style	Weight	Sample
Helvetica				A B C D E F G H I J K L M N O P Q R S T U V W X Y Z
Helvetica Condensed				A B C D E F G H I J K L M N O P Q R S T U V W X Y Z
Helvetica Condensed Bold				A B C D E F G H I J K L M N O P Q R S T U V W X Y Z
Helvetica Condensed Italic				A B C D E F G H I J K L M N O P Q R S T U V W X Y Z
Helvetica Condensed Bold Italic				A B C D E F G H I J K L M N O P Q R S T U V W X Y Z
Helvetica Normal				A B C D E F G H I J K L M N O P Q R S T U V W X Y Z
Helvetica Normal Italic				A B C D E F G H I J K L M N O P Q R S T U V W X Y Z
Helvetica Normal Bold				A B C D E F G H I J K L M N O P Q R S T U V W X Y Z
Helvetica Normal Bold Italic				A B C D E F G H I J K L M N O P Q R S T U V W X Y Z
Helvetica Condensed Normal				A B C D E F G H I J K L M N O P Q R S T U V W X Y Z
Helvetica Condensed Normal Italic				A B C D E F G H I J K L M N O P Q R S T U V W X Y Z
Helvetica Condensed Bold Normal				A B C D E F G H I J K L M N O P Q R S T U V W X Y Z
Helvetica Condensed Bold Normal Italic				A B C D E F G H I J K L M N O P Q R S T U V W X Y Z
Helvetica Condensed Italic Normal				A B C D E F G H I J K L M N O P Q R S T U V W X Y Z
Helvetica Condensed Italic Normal Italic				A B C D E F G H I J K L M N O P Q R S T U V W X Y Z
Helvetica Condensed Bold Italic Normal				A B C D E F G H I J K L M N O P Q R S T U V W X Y Z
Helvetica Condensed Bold Italic Normal Italic				A B C D E F G H I J K L M N O P Q R S T U V W X Y Z
Helvetica Condensed Italic Bold Normal				A B C D E F G H I J K L M N O P Q R S T U V W X Y Z
Helvetica Condensed Italic Bold Normal Italic				A B C D E F G H I J K L M N O P Q R S T U V W X Y Z
Helvetica Condensed Bold Italic Bold Normal				A B C D E F G H I J K L M N O P Q R S T U V W X Y Z
Helvetica Condensed Bold Italic Bold Normal Italic				A B C D E F G H I J K L M N O P Q R S T U V W X Y Z
Helvetica Condensed Italic Italic Normal				A B C D E F G H I J K L M N O P Q R S T U V W X Y Z
Helvetica Condensed Italic Italic Normal Italic				A B C D E F G H I J K L M N O P Q R S T U V W X Y Z
Helvetica Condensed Bold Italic Italic Normal				A B C D E F G H I J K L M N O P Q R S T U V W X Y Z
Helvetica Condensed Bold Italic Italic Normal Italic				A B C D E F G H I J K L M N O P Q R S T U V W X Y Z
Helvetica Condensed Italic Bold Italic Normal				A B C D E F G H I J K L M N O P Q R S T U V W X Y Z
Helvetica Condensed Italic Bold Italic Normal Italic				A B C D E F G H I J K L M N O P Q R S T U V W X Y Z
Helvetica Condensed Bold Italic Bold Italic Normal				A B C D E F G H I J K L M N O P Q R S T U V W X Y Z
Helvetica Condensed Bold Italic Bold Italic Normal Italic				A B C D E F G H I J K L M N O P Q R S T U V W X Y Z
Helvetica Condensed Italic Bold Italic Italic Normal				A B C D E F G H I J K L M N O P Q R S T U V W X Y Z
Helvetica Condensed Italic Bold Italic Italic Normal Italic				A B C D E F G H I J K L M N O P Q R S T U V W X Y Z
Helvetica Condensed Bold Italic Bold Italic Italic Normal				A B C D E F G H I J K L M N O P Q R S T U V W X Y Z
Helvetica Condensed Bold Italic Bold Italic Italic Normal Italic				A B C D E F G H I J K L M N O P Q R S T U V W X Y Z
Helvetica Condensed Italic Bold Italic Bold Italic Normal				A B C D E F G H I J K L M N O P Q R S T U V W X Y Z
Helvetica Condensed Italic Bold Italic Bold Italic Normal Italic				A B C D E F G H I J K L M N O P Q R S T U V W X Y Z
Helvetica Condensed Bold Italic Bold Italic Bold Italic Normal				A B C D E F G H I J K L M N O P Q R S T U V W X Y Z
Helvetica Condensed Bold Italic Bold Italic Bold Italic Normal Italic				A B C D E F G H I J K L M N O P Q R S T U V W X Y Z
Helvetica Condensed Italic Bold Italic Bold Italic Italic Normal				A B C D E F G H I J K L M N O P Q R S T U V W X Y Z
Helvetica Condensed Italic Bold Italic Bold Italic Italic Normal Italic				A B C D E F G H I J K L M N O P Q R S T U V W X Y Z
Helvetica Condensed Bold Italic Bold Italic Bold Italic Italic Normal				A B C D E F G H I J K L M N O P Q R S T U V W X Y Z
Helvetica Condensed Bold Italic Bold Italic Bold Italic Italic Normal Italic				A B C D E F G H I J K L M N O P Q R S T U V W X Y Z

PS Configuration Page

The settings of the [PS] options are printed.

1. Make sure that the printer is online.
2. Press [ / ] ( /  : Utility) to display the [Utility Menu] menu.
3. Select [PS Utility] using [▲] and [▼], and then press [OK].
4. Select [Configuration Page] using [▲] and [▼], and then press [OK].
5. Select [Yes] using [▼] in the [Execute?] display, and then press [OK] to output the page.

Font Samples

04L9-0RE

The fonts lists printed from the [Utility Menu] menu are a comprehensive listing of all fonts currently available. The listing contains the names and print samples of the fonts stored on the printer.

- ❖ Scalable Fonts (PCL)
- ❖ OCR Code Scalable Fonts (PCL) (LBP6680x Only)
- ❖ Bitmapped Fonts (PCL)
- ❖ PCL Fonts for Windows

Scalable Fonts (PCL)

Courier	ABCDEFGHIJKLMNOPQRSTUVWXYZ
CG Times	ABCDEFGHIJKLMNOPQRSTUVWXYZ
CG Times Bold	ABCDEFGHIJKLMNOPQRSTUVWXYZ
CG Times Italic	<i>ABCDEFGHIJKLMNOPQRSTUVWXYZ</i>
CG Times Bold Italic	<i>ABCDEFGHIJKLMNOPQRSTUVWXYZ</i>
CG Omega	ABCDEFGHIJKLMNOPQRSTUVWXYZ
CG Omega Bold	ABCDEFGHIJKLMNOPQRSTUVWXYZ
CG Omega Italic	<i>ABCDEFGHIJKLMNOPQRSTUVWXYZ</i>
CG Omega Bold Italic	<i>ABCDEFGHIJKLMNOPQRSTUVWXYZ</i>
Coronet	<i>ABCDEFGHIJKLMNOPQRSTUVWXYZ</i>
Clarendon Condensed Bold	ABCDEFGHIJKLMNOPQRSTUVWXYZ
Univers Medium	ABCDEFGHIJKLMNOPQRSTUVWXYZ
Univers Bold	ABCDEFGHIJKLMNOPQRSTUVWXYZ
Univers Medium Italic	<i>ABCDEFGHIJKLMNOPQRSTUVWXYZ</i>
Univers Bold Italic	<i>ABCDEFGHIJKLMNOPQRSTUVWXYZ</i>
Univers Condensed Medium	ABCDEFGHIJKLMNOPQRSTUVWXYZ
Univers Condensed Bold	ABCDEFGHIJKLMNOPQRSTUVWXYZ
Univers Condensed Medium Italic	<i>ABCDEFGHIJKLMNOPQRSTUVWXYZ</i>
Univers Condensed Bold Italic	<i>ABCDEFGHIJKLMNOPQRSTUVWXYZ</i>
Antique Olive	ABCDEFGHIJKLMNOPQRSTUVWXYZ
Antique Olive Bold	ABCDEFGHIJKLMNOPQRSTUVWXYZ
Antique Olive Italic	<i>ABCDEFGHIJKLMNOPQRSTUVWXYZ</i>
Garamond Antiqua	ABCDEFGHIJKLMNOPQRSTUVWXYZ
Garamond Halbfett	ABCDEFGHIJKLMNOPQRSTUVWXYZ
Garamond Kursiv	<i>ABCDEFGHIJKLMNOPQRSTUVWXYZ</i>

Garamond Kursiv Halbfett	<i>ABCDEFGHIJKLMNOPQRSTUVWXYZ</i>
Marigold	ABCDEFGHIJKLMNOPQRSTUVWXYZ
Albertus Medium	ABCDEFGHIJKLMNOPQRSTUVWXYZ
Albertus Extra Bold	ABCDEFGHIJKLMNOPQRSTUVWXYZ
Ryadh	ABCDEFGHIJKLMNOPQRSTUVWXYZ
Ryadh Bold	ABCDEFGHIJKLMNOPQRSTUVWXYZ
Malka	ABCDEFGHIJKLMNOPQRSTUVWXYZ
Malka Bold	ABCDEFGHIJKLMNOPQRSTUVWXYZ
Malka Italic	<i>ABCDEFGHIJKLMNOPQRSTUVWXYZ</i>
Dorit	ABCDEFGHIJKLMNOPQRSTUVWXYZ
Dorit Bold	ABCDEFGHIJKLMNOPQRSTUVWXYZ
Naarnit	ABCDEFGHIJKLMNOPQRSTUVWXYZ
Naarnit Bold	ABCDEFGHIJKLMNOPQRSTUVWXYZ
Arial	ABCDEFGHIJKLMNOPQRSTUVWXYZ
Arial Bold	ABCDEFGHIJKLMNOPQRSTUVWXYZ
Arial Italic	<i>ABCDEFGHIJKLMNOPQRSTUVWXYZ</i>
Arial Bold Italic	<i>ABCDEFGHIJKLMNOPQRSTUVWXYZ</i>
Times New Roman	ABCDEFGHIJKLMNOPQRSTUVWXYZ
Times New Roman Bold	ABCDEFGHIJKLMNOPQRSTUVWXYZ
Times New Roman Italic	<i>ABCDEFGHIJKLMNOPQRSTUVWXYZ</i>
Times New Roman Bold Italic	<i>ABCDEFGHIJKLMNOPQRSTUVWXYZ</i>
Helvetica	ABCDEFGHIJKLMNOPQRSTUVWXYZ
Helvetica Bold	ABCDEFGHIJKLMNOPQRSTUVWXYZ
Helvetica Oblique	<i>ABCDEFGHIJKLMNOPQRSTUVWXYZ</i>
Helvetica Bold Oblique	<i>ABCDEFGHIJKLMNOPQRSTUVWXYZ</i>

Helvetica Narrow	ABCDEFGHIJKLMNOPQRSTUVWXYZ
Helvetica Narrow Bold	ABCDEFGHIJKLMNOPQRSTUVWXYZ
Helvetica Narrow Oblique	<i>ABCDEFGHIJKLMNOPQRSTUVWXYZ</i>
Helvetica Narrow Bold Oblique	<i>ABCDEFGHIJKLMNOPQRSTUVWXYZ</i>
Palatino Roman	ABCDEFGHIJKLMNOPQRSTUVWXYZ
Palatino Bold	ABCDEFGHIJKLMNOPQRSTUVWXYZ
Palatino Italic	<i>ABCDEFGHIJKLMNOPQRSTUVWXYZ</i>
Palatino Bold Italic	<i>ABCDEFGHIJKLMNOPQRSTUVWXYZ</i>
ITC Avant Garde Gothic Book	ABCDEFGHIJKLMNOPQRSTUVWXYZ
ITC Avant Garde Gothic Demi	ABCDEFGHIJKLMNOPQRSTUVWXYZ
ITC Avant Garde Gothic Book Oblique	<i>ABCDEFGHIJKLMNOPQRSTUVWXYZ</i>
ITC Avant Garde Gothic Demi Oblique	<i>ABCDEFGHIJKLMNOPQRSTUVWXYZ</i>
ITC Bookman Light	ABCDEFGHIJKLMNOPQRSTUVWXYZ
ITC Bookman Demi	ABCDEFGHIJKLMNOPQRSTUVWXYZ
ITC Bookman Light Italic	<i>ABCDEFGHIJKLMNOPQRSTUVWXYZ</i>
ITC Bookman Demi Italic	<i>ABCDEFGHIJKLMNOPQRSTUVWXYZ</i>
New Century Schoolbook Roman	ABCDEFGHIJKLMNOPQRSTUVWXYZ
New Century Schoolbook Bold	ABCDEFGHIJKLMNOPQRSTUVWXYZ
New Century Schoolbook Italic	<i>ABCDEFGHIJKLMNOPQRSTUVWXYZ</i>
New Century Schoolbook Bold Italic	<i>ABCDEFGHIJKLMNOPQRSTUVWXYZ</i>
Times Roman	ABCDEFGHIJKLMNOPQRSTUVWXYZ
Times Bold	ABCDEFGHIJKLMNOPQRSTUVWXYZ
Times Italic	<i>ABCDEFGHIJKLMNOPQRSTUVWXYZ</i>
Times Bold Italic	<i>ABCDEFGHIJKLMNOPQRSTUVWXYZ</i>
ITC Zapf Chancery Medium Italic	<i>ABCDEFGHIJKLMNOPQRSTUVWXYZ</i>

Symbol	ΑΒΧΔΕΦΓΗΘΚΛΜΝΟΠΘΡΣΤΥϚΩΞΨΖ
SymbolPS	ΑΒΧΔΕΦΓΗΘΚΛΜΝΟΠΘΡΣΤΥϚΩΞΨΖ
Wingdings	ⒶⒷⒸⒹⒺⒻⒼⒽⒾⓀⓁⓂⓃⓄⓅⓆⓇⓈⓉⓊⓗⓉⓊⓋⓌⓍⓎⓏ
ITC Zapf Dingbats	ⒶⒷⒸⒹⒺⒻⒼⒽⒾⓀⓁⓂⓃⓄⓅⓆⓇⓈⓉⓊⓗⓉⓊⓋⓌⓍⓎⓏ
Courier Bold	ΑΒΧΔΕΦΓΗΘΚΛΜΝΟΠΘΡΣΤΥϚΩΞΨΖ
Courier Italic	<i>ΑΒΧΔΕΦΓΗΘΚΛΜΝΟΠΘΡΣΤΥϚΩΞΨΖ</i>
Courier Bold Italic	<i>ΑΒΧΔΕΦΓΗΘΚΛΜΝΟΠΘΡΣΤΥϚΩΞΨΖ</i>
Letter Gothic	ΑΒΧΔΕΦΓΗΘΚΛΜΝΟΠΘΡΣΤΥϚΩΞΨΖ
Letter Gothic Bold	ΑΒΧΔΕΦΓΗΘΚΛΜΝΟΠΘΡΣΤΥϚΩΞΨΖ
Letter Gothic Italic	<i>ΑΒΧΔΕΦΓΗΘΚΛΜΝΟΠΘΡΣΤΥϚΩΞΨΖ</i>
Naskh	ΑΒΧΔΕΦΓΗΘΚΛΜΝΟΠΘΡΣΤΥϚΩΞΨΖ
Naskh Bold	ΑΒΧΔΕΦΓΗΘΚΛΜΝΟΠΘΡΣΤΥϚΩΞΨΖ
Koufi	ΑΒΧΔΕΦΓΗΘΚΛΜΝΟΠΘΡΣΤΥϚΩΞΨΖ
Koufi Bold	ΑΒΧΔΕΦΓΗΘΚΛΜΝΟΠΘΡΣΤΥϚΩΞΨΖ
CourierPS	ΑΒΧΔΕΦΓΗΘΚΛΜΝΟΠΘΡΣΤΥϚΩΞΨΖ
CourierPS Bold	ΑΒΧΔΕΦΓΗΘΚΛΜΝΟΠΘΡΣΤΥϚΩΞΨΖ
CourierPS Oblique	<i>ΑΒΧΔΕΦΓΗΘΚΛΜΝΟΠΘΡΣΤΥϚΩΞΨΖ</i>
CourierPS Bold Oblique	<i>ΑΒΧΔΕΦΓΗΘΚΛΜΝΟΠΘΡΣΤΥϚΩΞΨΖ</i>

OCR Code Scalable Fonts (PCL) (LBP6680x Only)

OCR-A	ΑΒΧΔΕΦΓΗΘΚΛΜΝΟΠΘΡΣΤΥϚΩΞΨΖ
OCR-B	ΑΒΧΔΕΦΓΗΘΚΛΜΝΟΠΘΡΣΤΥϚΩΞΨΖ

Bitmapped Fonts (PCL)

Line Printer (10U)	ΑΒΧΔΕΦΓΗΘΚΛΜΝΟΠΘΡΣΤΥϚΩΞΨΖ
Line Printer (8U)	ΑΒΧΔΕΦΓΗΘΚΛΜΝΟΠΘΡΣΤΥϚΩΞΨΖ
Line Printer (0N)	ΑΒΧΔΕΦΓΗΘΚΛΜΝΟΠΘΡΣΤΥϚΩΞΨΖ
Line Printer (11U)	ΑΒΧΔΕΦΓΗΘΚΛΜΝΟΠΘΡΣΤΥϚΩΞΨΖ
Line Printer (12U)	ΑΒΧΔΕΦΓΗΘΚΛΜΝΟΠΘΡΣΤΥϚΩΞΨΖ
Line Printer (1U)	ΑΒΧΔΕΦΓΗΘΚ
Line Printer (2N)	ΑΒΧΔΕΦΓΗΘΚΛΜΝΟΠΘΡΣΤΥϚΩΞΨΖ
Line Printer (5N)	ΑΒΧΔΕΦΓΗΘΚΛΜΝΟΠΘΡΣΤΥϚΩΞΨΖ
Line Printer (6N)	ΑΒΧΔΕΦΓΗΘΚΛΜΝΟΠΘΡΣΤΥϚΩΞΨΖ
Line Printer (9N)	ΑΒΧΔΕΦΓΗΘΚΛΜΝΟΠΘΡΣΤΥϚΩΞΨΖ

PCL Fonts for Windows

 **NOTE**

66 PCL fonts for Windows are included in the User Manual CD-ROM supplied with this printer.

Albertus Medium	ABCDEFGHIJKLMNOPQRSTUVWXYZ
Albertus Extra Bold	ABCDEFGHIJKLMNOPQRSTUVWXYZ
Antique Olive	ABCDEFGHIJKLMNOPQRSTUVWXYZ
Antique Olive Italic	<i>ABCDEFGHIJKLMNOPQRSTUVWXYZ</i>
Antique Olive Bold	ABCDEFGHIJKLMNOPQRSTUVWXYZ
Clarendon Condensed	ABCDEFGHIJKLMNOPQRSTUVWXYZ
Coronet	<i>ABCDEFGHIJKLMNOPQRSTUVWXYZ</i>
Garamond Antiqua	ABCDEFGHIJKLMNOPQRSTUVWXYZ
Garamond Kursiv	<i>ABCDEFGHIJKLMNOPQRSTUVWXYZ</i>
Garamond Halbfett	ABCDEFGHIJKLMNOPQRSTUVWXYZ
Garamond Kursiv Halbfett	<i>ABCDEFGHIJKLMNOPQRSTUVWXYZ</i>
LetterGothic	ABCDEFGHIJKLMNOPQRSTUVWXYZ
LetterGothic-Italic	<i>ABCDEFGHIJKLMNOPQRSTUVWXYZ</i>
LetterGothic-Bold	ABCDEFGHIJKLMNOPQRSTUVWXYZ
Marigold	<i>ABCDEFGHIJKLMNOPQRSTUVWXYZ</i>
CG Omega	ABCDEFGHIJKLMNOPQRSTUVWXYZ
CG Omega-Italic	<i>ABCDEFGHIJKLMNOPQRSTUVWXYZ</i>
CG Omega-Bold	ABCDEFGHIJKLMNOPQRSTUVWXYZ
CG Omega-Bold Italic	<i>ABCDEFGHIJKLMNOPQRSTUVWXYZ</i>
CG Times	ABCDEFGHIJKLMNOPQRSTUVWXYZ
CG Times-Bold	ABCDEFGHIJKLMNOPQRSTUVWXYZ
CG Times-Italic	<i>ABCDEFGHIJKLMNOPQRSTUVWXYZ</i>
CG Times-Bold Italic	<i>ABCDEFGHIJKLMNOPQRSTUVWXYZ</i>
Univers Medium	ABCDEFGHIJKLMNOPQRSTUVWXYZ
Univers Medium Italic	<i>ABCDEFGHIJKLMNOPQRSTUVWXYZ</i>
Univers Bold	ABCDEFGHIJKLMNOPQRSTUVWXYZ
Univers Bold Italic	<i>ABCDEFGHIJKLMNOPQRSTUVWXYZ</i>
Univers Medium Condensed	ABCDEFGHIJKLMNOPQRSTUVWXYZ
Univers Medium Condensed Italic	<i>ABCDEFGHIJKLMNOPQRSTUVWXYZ</i>

Univers-Condensed-Bold	ABCDEFGHIJKLMNOPQRSTUVWXYZ
Univers-Condensed-Bold Italic	<i>ABCDEFGHIJKLMNOPQRSTUVWXYZ</i>
ITC Avant Garde Gothic Book	ABCDEFGHIJKLMNOPQRSTUVWXYZ
ITC Avant Garde Gothic Demi	ABCDEFGHIJKLMNOPQRSTUVWXYZ
ITC Avant Garde Gothic Oblique	ABCDEFGHIJKLMNOPQRSTUVWXYZ
ITC Avant Garde Gothic Demi Oblique	<i>ABCDEFGHIJKLMNOPQRSTUVWXYZ</i>
ITC Bookman Light	ABCDEFGHIJKLMNOPQRSTUVWXYZ
ITC Bookman Light Italic	<i>ABCDEFGHIJKLMNOPQRSTUVWXYZ</i>
ITC Bookman Demi	ABCDEFGHIJKLMNOPQRSTUVWXYZ
ITC Bookman Demi Italic	<i>ABCDEFGHIJKLMNOPQRSTUVWXYZ</i>
Courier	ABCDEFGHIJKLMNOPQRSTUVWXYZ
Courier Oblique	<i>ABCDEFGHIJKLMNOPQRSTUVWXYZ</i>
Courier Bold	ABCDEFGHIJKLMNOPQRSTUVWXYZ
Courier Bold Oblique	<i>ABCDEFGHIJKLMNOPQRSTUVWXYZ</i>
Helvetica	ABCDEFGHIJKLMNOPQRSTUVWXYZ
Helvetica Oblique	<i>ABCDEFGHIJKLMNOPQRSTUVWXYZ</i>
Helvetica Bold	ABCDEFGHIJKLMNOPQRSTUVWXYZ
Helvetica Bold Oblique	<i>ABCDEFGHIJKLMNOPQRSTUVWXYZ</i>
Helvetica Narrow	ABCDEFGHIJKLMNOPQRSTUVWXYZ
Helvetica Narrow Oblique	<i>ABCDEFGHIJKLMNOPQRSTUVWXYZ</i>
Helvetica Narrow Bold	ABCDEFGHIJKLMNOPQRSTUVWXYZ
Helvetica Narrow Bold Oblique	<i>ABCDEFGHIJKLMNOPQRSTUVWXYZ</i>
New Century Schoolbook Roman	ABCDEFGHIJKLMNOPQRSTUVWXYZ
New Century Schoolbook Italic	<i>ABCDEFGHIJKLMNOPQRSTUVWXYZ</i>
New Century Schoolbook Bold	ABCDEFGHIJKLMNOPQRSTUVWXYZ
New Century Schoolbook Bold Italic	<i>ABCDEFGHIJKLMNOPQRSTUVWXYZ</i>
Palatino Roman	ABCDEFGHIJKLMNOPQRSTUVWXYZ
Palatino Italic	<i>ABCDEFGHIJKLMNOPQRSTUVWXYZ</i>
Palatino Bold	ABCDEFGHIJKLMNOPQRSTUVWXYZ
Palatino Bold Italic	<i>ABCDEFGHIJKLMNOPQRSTUVWXYZ</i>
SymbolPS	ABXΔEΦΓHIθKAMNOΠIΘPΣTYζΩΞΨZ
Times Roman	ABCDEFGHIJKLMNOPQRSTUVWXYZ
Times Italic	<i>ABCDEFGHIJKLMNOPQRSTUVWXYZ</i>
Times Bold	ABCDEFGHIJKLMNOPQRSTUVWXYZ
Times Bold Italic	<i>ABCDEFGHIJKLMNOPQRSTUVWXYZ</i>
ITC Zapf Chancery Medium Italic	<i>ABCDEFGHIJKLMNOPQRSTUVWXYZ</i>
ITC Zapf Dingbats	☆†‡•◆♦◇☆★◎☆☆★★★☆☆☆☆☆☆☆☆☆☆

Office Locations

04L9-0RF

CANON INC.

30-2, Shimomaruko 3-chome, Ohta-ku, Tokyo 146-8501, Japan

CANON MARKETING JAPAN INC.

16-6, Konan 2-chome, Minato-ku, Tokyo 108-8011, Japan

CANON U.S.A., INC.

One Canon Park, Melville, NY 11747, U.S.A.

CANON EUROPA N.V.

Bovenkerkerweg 59, 1185 XB Amstelveen, The Netherlands

CANON CHINA CO. LTD.

15F Jinbao Building No.89, Jinbao Street, Dongcheng District, Beijing 100005, PRC

CANON SINGAPORE PTE LTD

1 HarbourFront Avenue, #04-01 Keppel Bay Tower, Singapore 098632

CANON AUSTRALIA PTY LTD

1 Thomas Holt Drive, North Ryde, Sydney NSW 2113, Australia

CANON GLOBAL WORLDWIDE SITES

<http://www.canon.com/>
