



# **MG7100 series Online Manual**

Read Me First  
Useful Functions Available on the Machine  
Overview of the Machine

# Contents

Read Me First. . . . .	7
How to Use the Online Manual. . . . .	8
Trademarks and Licenses. . . . .	9
Search Tips. . . . .	10
Window Used in Operation Explanation. . . . .	12
Useful Functions Available on the Machine. . . . .	13
Useful Functions Available from Applications and the Main Unit. . . . .	14
Helpful Functions Available Through the Network. . . . .	18
Online Storage Integration Function. . . . .	21
Printing with Google Cloud Print. . . . .	22
Preparations for Printing with Google Cloud Print. . . . .	23
Printing from Computer or Smartphone with Google Cloud Print. . . . .	26
Use PIXMA Cloud Link. . . . .	28
Application Management. . . . .	35
Cloud Windows. . . . .	40
Using Canon Inkjet Cloud Printing Center. . . . .	43
Printing Your Printer Registration ID. . . . .	55
Canon Inkjet Cloud Printing Center window. . . . .	56
Requirements for Canon Inkjet Cloud Printing Center operation. . . . .	70
Using Remote UI. . . . .	71
Printing from AirPrint Compliant Device. . . . .	74
How to Use Print from E-mail. . . . .	79
Preparing to Use Print from E-mail. . . . .	84
Timezone List. . . . .	87
Overview of the Machine. . . . .	88
Safety Guide. . . . .	89
Safety Precautions. . . . .	90
Regulatory and Safety Information. . . . .	91
Main Components and Basic Operations. . . . .	95
Main Components. . . . .	96
Front View. . . . .	97
Rear View. . . . .	99

Inside View. . . . .	100
Operation Panel. . . . .	101
About the Power Supply of the Machine. . . . .	103
Confirming that the Power Is On. . . . .	104
Turning the Machine On and Off. . . . .	105
Notice for the Power Plug/Power Cord. . . . .	107
Notice for Unplugging the Power Cord. . . . .	108
Using the Operation Panel. . . . .	109
<b>Loading Paper / Originals. . . . .</b>	<b>114</b>
Loading Paper. . . . .	115
Paper Sources to Load Paper. . . . .	116
Loading Small Size Paper. . . . .	118
Loading Large Size Paper. . . . .	122
Loading Envelopes. . . . .	127
Media Types You Can Use. . . . .	131
Paper Load Limit. . . . .	134
Media Type Settings on the Operation Panel. . . . .	136
Media Types You Cannot Use. . . . .	137
Before Printing on Art Paper. . . . .	138
Printing Area. . . . .	140
Printing Area. . . . .	141
Other Sizes than Letter, Legal, Envelopes. . . . .	143
Letter, Legal. . . . .	144
Sizes for Art Paper. . . . .	145
Envelopes. . . . .	147
Printable Discs. . . . .	148
Placing a Printable Disc. . . . .	149
Cautions When Printing on a Printable Disc. . . . .	150
Before Placing a Printable Disc. . . . .	151
Placing a Printable Disc. . . . .	152
Removing a Printable Disc. . . . .	154
How to Detach / Attach the Disc Tray. . . . .	156
Loading Originals. . . . .	157
Loading Originals on the Platen Glass. . . . .	158
How to Load Originals for Each Function. . . . .	160
Originals You Can Load. . . . .	163
How to Detach / Attach the Document Cover. . . . .	164

Inserting the Memory Card. . . . .	165
Before Inserting the Memory Card. . . . .	166
Inserting the Memory Card. . . . .	168
Removing the Memory Card. . . . .	171
<b>Replacing an Ink Tank. . . . .</b>	<b>172</b>
Replacing an Ink Tank. . . . .	173
Checking the Ink Status. . . . .	179
Checking the Ink Status with the Touch Screen on the Machine. . . . .	180
Checking the Ink Status with the Ink Lamps. . . . .	181
<b>Maintenance. . . . .</b>	<b>183</b>
When Printing Becomes Faint or Colors Are Incorrect. . . . .	184
Maintenance Procedure. . . . .	185
Printing the Nozzle Check Pattern. . . . .	188
Examining the Nozzle Check Pattern. . . . .	190
Cleaning the Print Head. . . . .	192
Cleaning the Print Head Deeply. . . . .	194
Aligning the Print Head. . . . .	196
Aligning the Print Head Manually. . . . .	199
Performing Maintenance from a Computer. . . . .	205
Cleaning the Print Heads from Your Computer. . . . .	206
Cleaning the Paper Feed Rollers from Your Computer. . . . .	209
Aligning the Print Head Position from Your Computer. . . . .	210
Aligning the Print Head Position Manually from Your Computer. . . . .	212
Use Your Computer to Print a Nozzle Check Pattern. . . . .	217
Cleaning Inside the Machine. . . . .	218
Cleaning the Machine. . . . .	219
Cleaning the Exterior of the Machine. . . . .	220
Cleaning the Platen Glass and Document Cover. . . . .	221
Cleaning the Paper Feed Roller. . . . .	222
Cleaning the Inside of the Machine (Bottom Plate Cleaning). . . . .	225
Cleaning the Protrusions inside the Machine. . . . .	228
Cleaning the Pad in the Cassette. . . . .	229
<b>Changing the Machine Settings. . . . .</b>	<b>230</b>
Changing Machine Settings from Your Computer. . . . .	231
Changing the Print Options. . . . .	232
Registering a Frequently Used Printing Profile. . . . .	234
Managing the Machine Power. . . . .	236

Reducing the Machine Noise. . . . .	238
Changing the Machine Operation Mode. . . . .	240
Changing the Machine Settings Using the Operation Panel. . . . .	243
Changing the Machine Settings Using the Operation Panel. . . . .	244
Print settings. . . . .	246
LAN settings. . . . .	247
Device user settings. . . . .	251
PictBridge print settings. . . . .	252
Language selection. . . . .	254
Home screen background color. . . . .	255
Firmware update. . . . .	256
Reset setting. . . . .	257
About ECO settings. . . . .	258
About Quiet setting. . . . .	260
Before Using the Machine with the Access Point Mode. . . . .	261
Setting Up the Card Slot as the Memory Card Drive of the Computer. . . . .	263
Setting Up the Card Slot as the Memory Card Drive of the Computer. . . . .	264
Information about Network Connection. . . . .	266
Useful Information about Network Connection. . . . .	267
Initial Values Set at Factory (Network). . . . .	268
Connecting the Machine to the Computer Using a USB Cable. . . . .	269
When Detecting the Printers Have the Same Name during Setup. . . . .	270
Connecting to Other Computer with LAN/Changing the Connection Method from USB to LAN. . . . .	271
Printing Out Network Setting Information. . . . .	272
About Network Communication. . . . .	275
Changing and Confirming Network Settings. . . . .	276
IJ Network Tool. . . . .	277
Changing the Settings in the Wireless LAN Sheet. . . . .	278
Changing the WEP Detailed Settings. . . . .	280
Changing the WPA or WPA2 Detailed Settings. . . . .	282
Changing the Settings in the Wired LAN Sheet. . . . .	285
Changing the Settings in the Admin Password Sheet. . . . .	286
Monitoring Wireless Network Status. . . . .	287
Initializing the Network Settings of the Machine. . . . .	290
Viewing the Modified Settings. . . . .	291
Screens for Network Connection of IJ Network Tool. . . . .	292
Canon IJ Network Tool Screen. . . . .	293

Configuration Screen. . . . .	296
Wireless LAN Sheet. . . . .	297
Search Screen. . . . .	299
WEP Details Screen. . . . .	301
WPA Details Screen. . . . .	302
WPA2 Details Screen. . . . .	303
Authentication Type Confirmation Screen. . . . .	304
PSK: Passphrase and Dynamic Encryption Setup Screen. . . . .	305
Setup Information Confirmation Screen. . . . .	306
Wired LAN Sheet. . . . .	307
Admin Password Sheet. . . . .	308
Network Information Screen. . . . .	309
Access Control Sheet. . . . .	310
Edit Accessible MAC Address Screen/Add Accessible MAC Address Screen. . . . .	314
Edit Accessible IP Address Screen/Add Accessible IP Address Screen. . . . .	315
Other Screens of IJ Network Tool. . . . .	316
Canon IJ Network Tool Screen. . . . .	317
Status Screen. . . . .	320
Connection Performance Measurement Screen. . . . .	321
Maintenance Screen. . . . .	323
Network Setup of the Card Slot Screen. . . . .	324
Associate Port Screen. . . . .	326
Network Information Screen. . . . .	327
Appendix for Network Communication. . . . .	328
Using the Card Slot over a Network. . . . .	329
When the Printer Driver Is Not Associated with a Port. . . . .	331
About Technical Terms. . . . .	332
Restrictions. . . . .	338
About Firewall. . . . .	339
Tips for Ensuring Optimal Printing Quality. . . . .	340
Useful Information about Ink. . . . .	341
Key Points to Successful Printing. . . . .	343
Be Sure to Make Paper Settings after Loading Paper. . . . .	344
Canceling a Print Job. . . . .	345
Key to Enjoying Consistent Printing Quality. . . . .	346
Precautions for Safe Transport of the Machine. . . . .	347
Legal Limitations on Use of Your Product and Use of Images. . . . .	349
Specifications. . . . .	350

# Read Me First

➔ [Notes on Online Manual Usage](#)

➔ [How to Print](#)

## Notes on Online Manual Usage

- Reproduction, diversion or copying of any text, photo or image published in the *Online Manual* (hereinafter referred to as "this guide"), in whole or in part, is prohibited.
- In principle, Canon shall change or delete the contents of this guide without prior notice to customers. In addition, Canon may suspend or stop the disclosure of this guide due to unavoidable reasons. Canon shall not be liable for any damage suffered by customers as a result of changes in or deletion of information in this guide, or suspension/stoppage of disclosure of this guide.
- Although the contents of this guide have been prepared with utmost care, please contact the service center if you find any incorrect or missing information.
- In principle, the descriptions in this guide are based on the product at the time of its initial sale.
- This guide does not disclose the manuals of all the products sold by Canon. See the manual supplied with the product when using a product that is not described in this guide.

## How to Print

Use the print function of your Web browser to print this guide.

To set to print background colors and images, follow the steps below.

### ▶▶▶ Note

- In Windows 8, print in the desktop version.

#### • In Internet Explorer 9 or 10

1. Select  (Tools) > **Print** > **Page setup...**
2. Select the **Print Background Colors and Images** checkbox.

#### • In Internet Explorer 8

1. Press the Alt key to display the menus.  
Alternatively, from **Tools**, select **Toolbars** > **Menu Bar** to display the menus.
2. Select **Page Setup...** from the **File** menu.
3. Select the **Print Background Colors and Images** checkbox.

#### • In Mozilla Firefox

1. Press the Alt key to display the menus.  
Alternatively, click **Firefox**, then select **Menu Bar** from the right arrow of **Options** to display the menus.
2. Select **Page Setup...** from the **File** menu.
3. Select the **Print Background (colors & images)** checkbox in **Format & Options**.

# How to Use the Online Manual

## Symbols Used in This Document

### **Warning**

Instructions that, if ignored, could result in death or serious personal injury caused by incorrect operation of the equipment. These must be observed for safe operation.

### **Caution**

Instructions that, if ignored, could result in personal injury or material damage caused by incorrect operation of the equipment. These must be observed for safe operation.

### **Important**

Instructions including important information. To avoid damage and injury or improper use of the product, be sure to read these indications.

### **Note**

Instructions including notes for operation and additional explanations.

### **Basic**

Instructions explaining basic operations of your product.

### **Note**

- 
- Icons may vary depending on your product.
- 

## Touch-enabled Device Users

For touch actions, you need to replace "right-click" in this document with the action set on the operating system. For example, if the action is set to "press and hold" on your operating system, replace "right-click" with "press and hold."



## Trademarks and Licenses

- Microsoft is a registered trademark of Microsoft Corporation.
- Windows is a trademark or registered trademark of Microsoft Corporation in the U.S. and/or other countries.
- Windows Vista is a trademark or registered trademark of Microsoft Corporation in the U.S. and/or other countries.
- Internet Explorer is a trademark or registered trademark of Microsoft Corporation in the U.S. and/or other countries.
- Mac, Mac OS, AirPort, Safari, Bonjour, iPad, iPhone and iPod touch are trademarks of Apple Inc., registered in the U.S. and other countries. AirPrint and the AirPrint logo are trademarks of Apple Inc.
- IOS is a trademark or registered trademark of Cisco in the U.S. and other countries and is used under license.
- Google Cloud Print, Google Chrome, Android and Google Play are either registered trademarks or trademarks of Google Inc.
- Adobe, Photoshop, Photoshop Elements, Lightroom, Adobe RGB and Adobe RGB (1998) are either registered trademarks or trademarks of Adobe Systems Incorporated in the United States and/or other countries.
- Photo Rag is a trademark of Hahnemühle FineArt GmbH.
- Bluetooth is a trademark of Bluetooth SIG, Inc., U.S.A. and licensed to Canon Inc.
- All other company names and products mentioned herein may be trademarks or registered trademarks of their respective companies.

### Note

- The formal name of Windows Vista is Microsoft Windows Vista operating system.

Enter keywords in the search window and click  (Search).

You can search for target pages in this guide.

Entry example: "(your product's model name) load paper", "(your product's model name) 1000"

---

## Search Tips

You can search for target pages by entering keywords in the search window.

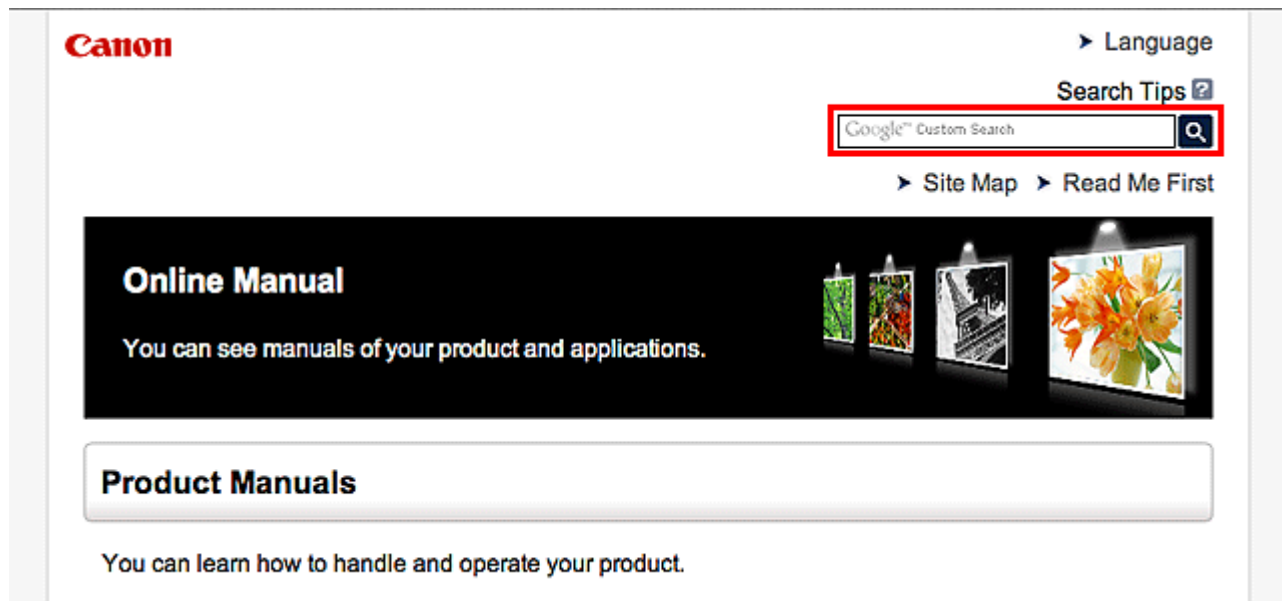

### ▶▶▶ Note

- The displayed screen may vary.

- **Searching for Functions**

You can find target pages easily by entering your product's model name and a keyword for the function you want to learn about.

Example: When you want to learn how to load paper

Enter "(your product's model name) load paper" in the search window and perform a search

- **Troubleshooting Errors**

You can obtain more accurate search results by entering your product's model name and a support code.

Example: When the following error screen appears

Enter "(your product's model name) 1000" in the search window and perform a search

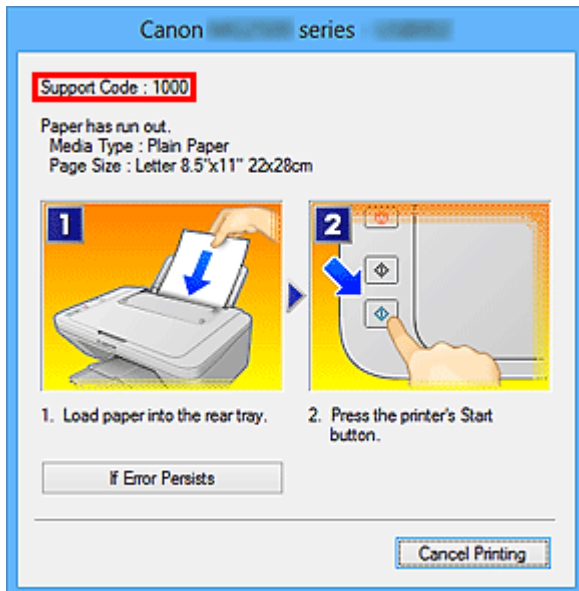

### ►►► Note

- The displayed screen varies depending on your product.

#### • **Searching for Application Functions**

You can find target pages easily by entering your application's name and a keyword for the function you want to learn about.

Example: When you want to learn how to print collages with My Image Garden  
Enter "My Image Garden collage" in the search window and perform a search

#### • **Searching for Reference Pages**

You can search for reference pages described in this guide by entering your model name and a page title.

You can find reference pages more easily by entering the function name as well.

Example: When you want to browse the page referred to by the following sentence on a scanning procedure page

Refer to "Color Settings Tab" for your model from Home of the *Online Manual* for details.

Enter "(your product's model name) scan Color Settings Tab" in the search window and perform a search

## **Window Used in Operation Explanation**

In this guide, most of the operations are described based on the windows displayed when Windows 8 operating system (called Windows 8 below) is used.

## Useful Functions Available on the Machine

The following useful functions are available on the machine.  
Enjoy pleasant photography experience by utilizing various functions.

### ▶ Helpful Functions Available Through the Network



You can print more conveniently through integration with smartphones and other devices or with services on the web.

### PIXMA Cloud Link



### ▶ Useful Functions Available from Applications and the Main Unit



You can create items such as collages easily or download delightful printing materials, and print them.

# Useful Functions Available from Applications and the Main Unit

On the machine, the following useful functions are available from applications and the main unit.

- [Print Photos Easily](#)
- [Connect Wirelessly with Ease](#)
- [Print Disc Labels \(CD/DVD/BD\)](#)
- [Download Content Materials](#)
- [Print Photos on Facebook](#)

## Print Photos Easily Using an Application

### Organize Images Easily

In My Image Garden, you can register the names of people and events to photos.

You can organize photos easily as you can display them not only by folder but also by calendar, event, and person. This also allows you to find the target photos easily when you search for them later on.

<Calendar View>



<People View>

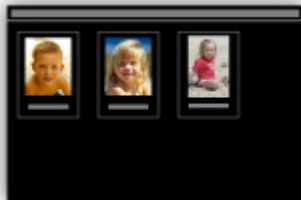

### Display Recommended Items in Slide Shows

Based on the information registered to photos, Quick Menu automatically selects the photos on your computer and creates recommended items such as collages and cards. The created items appear in slide shows.



If there is an item you like, you can easily print it in just two steps.

1. In Image Display of Quick Menu, select the item you want to print.
2. Print the item with My Image Garden.



### Place Photos Automatically

Delightful items are created easily as the selected photos are placed automatically according to the theme.



### Other Various Functions

My Image Garden has many other useful functions.

Refer to "What You Can Do with My Image Garden" for details.

### Connect Wirelessly with Ease in "Access Point Mode"

The machine supports "access point mode" in which you can connect to the machine wirelessly from a computer or smartphone even in an environment without an access point or wireless LAN router.

Switch to "access point mode" with simple steps to enjoy scanning and printing wirelessly.

When you use the machine with the access point mode, be sure to specify the access point name of the machine and the security setting in advance.

➔ [Before Using the Machine with the Access Point Mode](#)

For details on printing or scanning with the access point mode:

- ➔ Printing with the Access Point Mode
- ➔ Scanning with the Access Point Mode



## Create and Print Personalized Disc Labels (CD/DVD/BD) Easily and Beautifully

### Print without a Computer

You can enjoy disc label printing easily even without using a computer.

Refer to "About Disc Label Printing" for details.

### Create Items with Applications and Print Them

Use My Image Garden to combine your favorite photos with preset themes to create and print personalized disc labels.

Refer to "Printing Disc Labels (CD/DVD/BD)" for details.



## Download a Variety of Content Materials

### CREATIVE PARK

A "printing materials site" where you can download all the printing materials for free.

Various types of content such as seasonal cards and paper crafts that can be made by assembling



paper parts are provided.  
It is easily accessible from Quick Menu.

## CREATIVE PARK PREMIUM

A service where customers using models that support PREMIUM Contents can download exclusive printing materials.

PREMIUM Contents can be downloaded easily via My Image Garden. Downloaded PREMIUM Contents can be printed directly with My Image Garden.

To download PREMIUM Contents, make sure that genuine Canon ink tanks/ink cartridges are installed for all colors on a supported printer.



### ►► Note

- The designs of PREMIUM Contents provided in this page are subject to change without prior notice.

## Print Photos on Facebook Easily Using a Facebook App "Print Your Days"

Use Print Your Days to collect Facebook photos of memories of parties and travel, recent activity of your family and friends, your hobbies, etc., then create and print a work of art.

Print Your Days is available from the Print Your Days Facebook page.



## Helpful Functions Available Through the Network

The following useful functions are available on the machine.

Enjoy even more pleasant photography experience by utilizing various functions.

- ➔ [Use App from Various Environments by Using PIXMA Cloud Link](#)
- ➔ [Upload scanned images to the web](#)
- ➔ [Print web data easily](#)
- ➔ [Print by using Google Cloud Print](#)
- ➔ [Print directly from your iPad, iPhone, or iPod touch](#)
- ➔ [Manage Your Printer from a Remote Location by Using Remote UI](#)
- ➔ [Print Easily by Sending E-mail from Your Computer or Smartphone](#)
- ➔ [Print easily from your smartphone by using PIXMA Printing Solutions](#)
- ➔ [Printing with Windows RT](#)

### Use App from Various Environments by Using PIXMA Cloud Link

By using PIXMA Cloud Link, you can access an application that supports this service and use it directly without using your computer. In addition to printing photos and documents from various applications, you can register and manage applications.

Refer to "[Use PIXMA Cloud Link](#)" for details.

### Upload Scanned Images Easily to the Web

If you use Evernote or Dropbox on your computer, you can easily upload scanned images to the web. Uploaded images can be utilized from other computers, smartphones, etc.

Refer to "[Online Storage Integration Function](#)" for details.



### Print Photos on Photo-Sharing Services or Print Web Template Forms Easily from the Machine

You can directly print photos on photo-sharing services or template forms offered on the web without using a computer.

- **Online Album Photo Print**

You can access photo-sharing services on the web from the machine and directly print photos in online albums (such as Picasa Web Albums) while checking them on the printer screen.

- **Web Template Form Print**

Canon offers various template forms including seasonal stationery and calendars on the web. You can download and print the template forms you want anytime, as much as you need, by operating the machine only.



## **Print in Various Environments with Google Cloud Print**

The machine is compatible with Google Cloud Print (Google Cloud Print is a service provided by Google Inc.).

By using Google Cloud Print, you can print from anywhere with applications or services supporting Google Cloud Print.

Refer to "[Printing with Google Cloud Print](#)" for details.

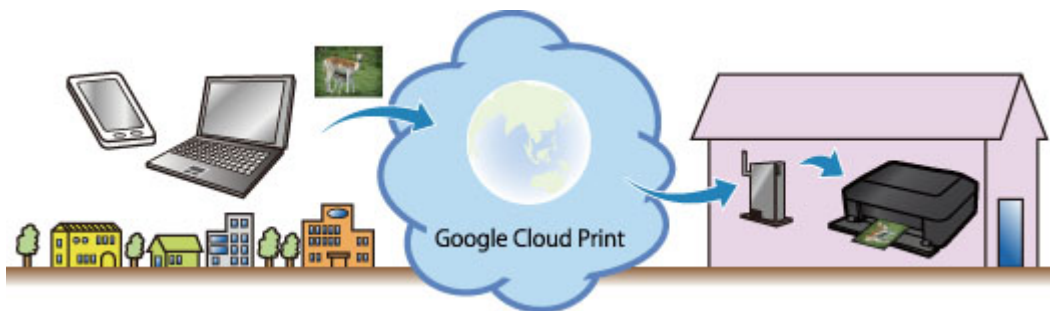

## **Print Directly from iPad, iPhone, or iPod touch with Apple AirPrint**

The machine is compatible with the AirPrint function of Apple iOS devices.

You can directly print e-mails, photos, web pages, etc. from iPad, iPhone, or iPod touch to the machine over wireless LAN.

Refer to "[Printing from AirPrint Compliant Device](#)" for details.



## Manage Your Printer from a Remote Location by Using Remote UI

By using **Remote UI**, you can set up this machine, check the machine status, and even perform maintenance from your computer or smartphone.

Because you can use this service from a remote location through the network, you can check printer information even when you're out away from the printer.

Refer to "[Using Remote UI](#)" for details.

## Print Easily by Sending E-mail from Your Computer or Smartphone

By using **Print from E-mail**, you can easily print a photo or document saved on your computer or smartphone just by attaching it to an e-mail.

You can easily print from your travel destination or an outside location. You can even let friends and family print on the printer by setting up your printer beforehand.

Refer to "[How to Use Print from E-mail](#)" for details.



## Print Easily from a Smartphone with PIXMA Printing Solutions

Use PIXMA Printing Solutions to easily print photos saved on a smartphone wirelessly.

You can also receive scanned data (PDF or JPEG) directly on a smartphone without using a computer.

PIXMA Printing Solutions can be downloaded from App Store and Google Play.



## Printing with Windows RT

When you use Windows RT, printing is easy because you simply connect this machine to the network.

For information about connecting to the network, see [here](#).

When the connection is complete, the Canon Inkjet Print Utility software, which allows you to specify detailed print settings, is downloaded automatically.

By using Canon Inkjet Print Utility, you can check the printer status and specify detailed print settings. (The available functions will differ depending on your usage environment and connection method.)

## Online Storage Integration Function

The machine can integrate with online storage services such as Evernote.



### Integration with Online Notetaking Service "Evernote"

If an Evernote client application is installed on your computer, you can import scanned images into the application and upload them to the Evernote server.

The uploaded images can be browsed from other computers, smartphones, etc.

To use Evernote, you need to create an account. See the "CREATE ACCOUNT" page of Evernote for account creation.

- **Settings**

In the Settings Dialog Box of IJ Scan Utility, select the item you want to set, then select Evernote for **Send to an application** in **Application Settings**.

Refer to "Settings Dialog Box" for your model from Home of the *Online Manual* for details.

### **»» Important**

- The Evernote service features are subject to change or termination without prior notice.

# Printing with Google Cloud Print

The machine is compatible with Google Cloud Print™ (Google Cloud Print is a service provided by Google Inc.).

By using Google Cloud Print, you can print from anywhere with applications or services supporting Google Cloud Print.

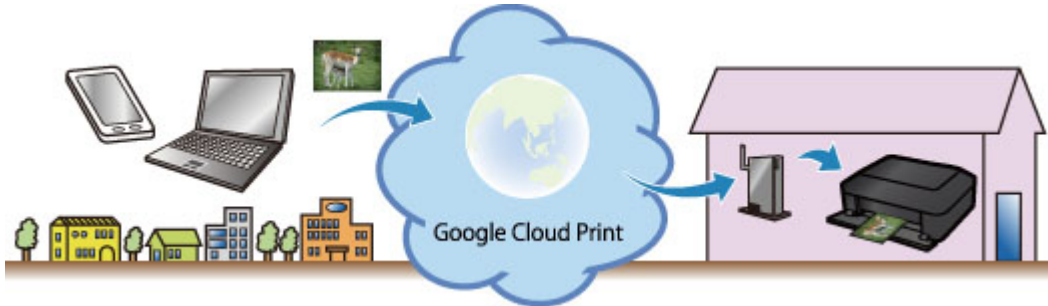

1. [Preparations for Printing with Google Cloud Print](#)
2. [Printing from Computer or Smartphone with Google Cloud Print](#)

## ▶▶▶ Important

- LAN connection with the machine and Internet connection are required to register the machine and to print with Google Cloud Print. Internet connection fees apply.
- This function may not be available depending on the country or region you live in.

# Preparations for Printing with Google Cloud Print

To print with Google Cloud Print, you need to get Google account and register the machine with Google Cloud Print in advance.

➔ [Getting Google Account](#)

If you already have Google account, register the machine.

➔ [Registering the Machine with Google Cloud Print](#)

## Getting Google Account

First, get your Google account in order to register the machine with Google Cloud Print.

Access to Google Cloud Print with the web browser on the computer or the mobile device, then register the required information.

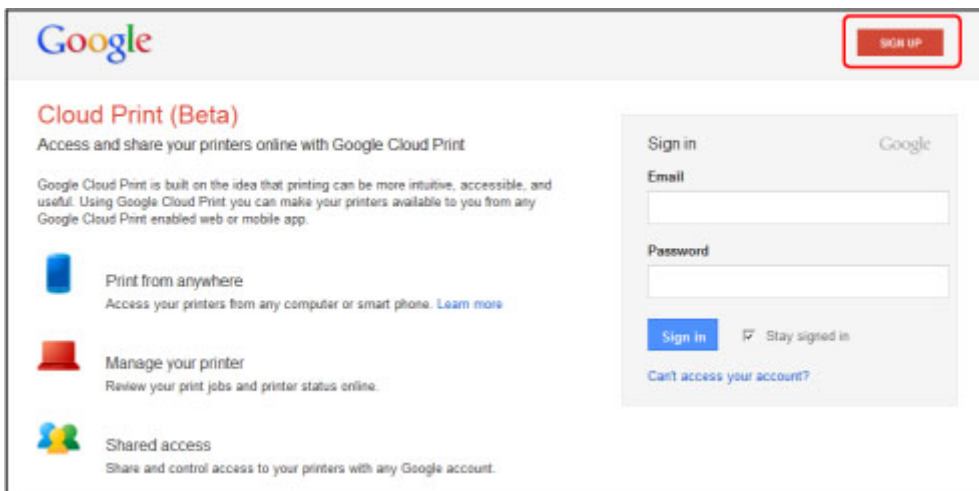

\* The screen above may change without prior notice.

## Registering the Machine with Google Cloud Print

Register the machine with Google Cloud Print.

The authentication procedure using the web browser on the computer or the mobile device is required in the process of registering. Because the authentication URL is printed from machine when the authentication process is performed, prepare A4 or Letter-sized plain paper.

### ►►► Important

- LAN connection with the machine and Internet connection are required to register the machine and to print with Google Cloud Print. Internet connection fees apply.
- If the machine's owner changes, [delete the machine from Google Cloud Print](#).

1. Make sure that the machine is turned on.

### If your printer has a LCD monitor

2. Display the Home screen.

3. Select  **Setup.**

4. Select  **Web service setup -> Web service connection setup -> Google Cloud Print setup -> Register with Google Cloud Print.**

▶▶▶ **Note**

- If you have already registered the machine with Google Cloud Print, the confirmation message to re-register the machine is displayed.

5. When the confirmation screen to register the machine is displayed, select **Yes**.

6. Select a display language on the print setting screen of Google Cloud Print.

The confirmation message to print the authentication URL is displayed.

7. Load A4 or Letter-sized plain paper, then select OK.

The authentication URL is printed.

8. Ensure that the authentication URL is printed, select **Yes**.

9. Perform the authentication process using the web browser on the computer or the mobile device.

Access to the URL using the web browser on the computer or the mobile device and perform the authentication process following the on-screen instructions.

▶▶▶ **Note**

- Perform the authentication process with your Google account which you have gotten in advance.

10. When the message that the registration is complete is displayed on the LCD of the machine, select OK.

When authentication process is complete properly, the registration items are displayed. When authentication process is complete, [you can print the data with Google Cloud Print](#).

When authentication process is not complete properly and the error message is displayed, select OK. When the confirmation message to print the authentication URL is displayed, print the authentication URL, then perform the authentication process on the computer again.

## If your printer does not have a LCD monitor

2. [Remote UI startup](#)

3. Select **Google Cloud Print setup -> Register with Google Cloud Print**



### »»» Note

- If you have already registered the machine with Google Cloud Print, the confirmation message to re-register the machine is displayed.

4. When the confirmation screen to register the machine is displayed, select **Yes**.
5. In the print setup for Google Cloud Print, select the display language, and then select **Authentication**.
6. When the registration completion message appears, select OK.

## Deleting the Machine from Google Cloud Print

If the machine's owner changes or if you want to re-register the machine, delete the machine from Google Cloud Print by following the steps below.

1. Make sure that the machine is turned on.

### If your printer has a LCD monitor

2. Display the Home screen.

3. Select  **Setup**.

4. Select  **Web service setup -> Web service connection setup -> Google Cloud Print setup -> Delete from Google Cloud Print**.

5. When the confirmation screen to delete the machine is displayed, select **Yes**.

### If your printer does not have a LCD monitor

2. [Remote UI startup](#)
3. Select **Google Cloud Print setup -> Delete from Google Cloud Print**.
4. When the confirmation screen to delete the machine is displayed, select **Yes**.

# Printing from Computer or Smartphone with Google Cloud Print

When you send print data with Google Cloud Print, the machine receives the print data and prints it automatically if the machine is turned on.

When printing from a computer, smartphone, or other external device with Google Cloud Print, load paper into the machine in advance.

## Sending the Print Data with Google Cloud Print

1. Make sure that the machine is turned on.

### ▶▶▶ Note

- If you want to send the print data from an outside location, turn on the machine in advance.

2. Print from the computer or smartphone.

The figure below is an example of when printing from the web browser corresponding with Google Cloud Print. The screen differs depending on the applications or services supporting Google Cloud Print.

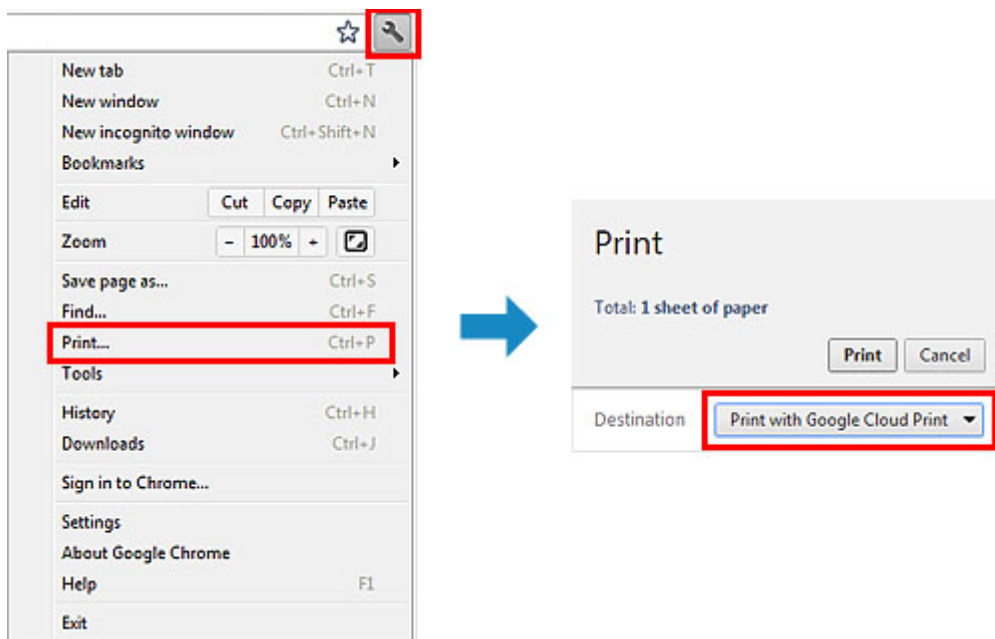

When the preparation for printing with Google Cloud Print is complete and when the machine is turned on, the machine receives the print data and prints it automatically.

### ▶▶▶ Note

- Depending on the communication status, it may take a while to print the print data or the machine may not receive the print data.
- While printing with Google Cloud Print, the printing may be canceled depending on the machine's status, such as when the machine is being operated or an error has occurred. To resume printing, check the machine's status, then print with Google Cloud Print again.
- For print settings:
  - If you select the media type other than plain paper or if you select the paper size other than A4/ Letter/B5/A5-size, the print data is printed in single-sided even when you select the duplex print setting. (\* The paper size differs depending on the model of your printer. For information about

the supported paper sizes, go to the *Online Manual* home page, and refer to the "Cannot Print Properly with Automatic Duplex Printing" for your model.)

- If you select plain paper as media type or if you select B5/A5-size as paper size, the print data is printed with border even when you select the borderless print setting.
- The print results may differ from the print image depending on the print data.
- Depending on the device sending the print data, you may not select the print settings when sending the print data with Google Cloud Print.

## When you want to print from Google Cloud Print immediately

When the machine cannot receive the print data, or you want to start printing immediately, you can check whether there is a print job on the Google Cloud Print and start printing manually.

Follow the steps below.

### ▶▶ Important

- Depending on your printer model, this function may not be available.

1. Make sure that the machine is turned on.
2. Display the Home screen.

3. Select  **Setup**.

4. Select **Web service inquiry**.

### ▶▶ Note

- If you have not registered the machine with Google Cloud Print, **Web service inquiry** is not displayed.

[Register the machine with Google Cloud Print.](#)

5. Select **Print from Google Cloud Print**.

The confirmation screen to check is displayed.

6. Select **Yes**.

If there is the print data, the machine receives the print data and prints it.

## Use PIXMA Cloud Link

By using PIXMA Cloud Link, you can connect your printer to a cloud service, such as CANON iMAGE GATEWAY, Evernote, or Twitter, and use the following functions without using a computer:

- Print images from a photo-sharing service
- Print documents from a data management service
- Use Twitter to report the printer status, such as no paper or ink empty

In addition, you can use various functions by adding and registering apps that are linked with various cloud services.

Also, if you register to [Canon Inkjet Cloud Printing Center](#), you can also use these functions from your smartphone or tablet device.



### ▶▶▶ Important

- In certain countries, PIXMA Cloud Link may not be available or the available apps may be different.
- Some apps require that you have an account before you use those apps. For such apps, please set up an account beforehand.
- To find out which models support PIXMA Cloud Link check the Canon homepage.
- The screen display may change without prior notice.

- ➔ [Before Using PIXMA Cloud Link](#)
- ➔ [Preparing to use PIXMA Cloud Link from your printer](#)
- ➔ [Using PIXMA Cloud Link](#)
- ➔ [Cloud troubleshooting](#)

## Before Using PIXMA Cloud Link

First, check your environment.

- **Network environment**

The printer must be connected to a LAN and to the Internet.

If your printer is not connected to a LAN, see here and set one up.

For information on the LAN and Internet settings, see the manual of your network devices or contact the manufacturer.

### »» Important

- The user will bear the cost of Internet access.

#### • **Printer software (firmware) version**

If the printer's firmware version is earlier than Ver. 2.000, you need to update the firmware. Refer to "Firmware update" for your model from the Home of the *Online Manual* for details.

### »» Important

- When you update the firmware of this product, the displayed screens, the operation procedures, and the functions may change.
- If you register a photo-sharing service to your printer and then later update the printer firmware, the photo-sharing service will be deregistered. Please perform the account setup again.

## Preparing to use PIXMA Cloud Link from your printer

Follow the steps described below to register the printer information.  
The screen display differs depending on your computer.

1. Check that the printer is connected to the Internet

2. From the printer home screen, select  **Cloud**

3. Registration to the server will take place

When the registration completed screen appears, select **OK**.

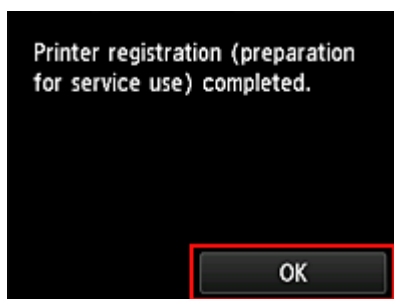

4. On the confirmation screen, select **Next**

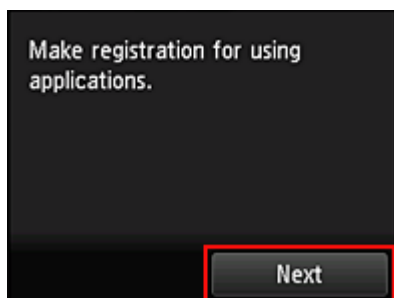

5. In the **License agreement** and **Privacy statement** windows, read the statements, and then select **Agree** if you agree



<License agreement>

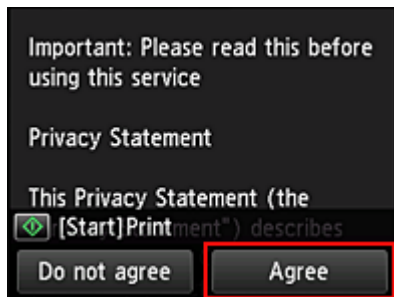

<Privacy statement>

#### »» Note

- If you select **Disagree**, a confirmation screen of canceling the user information registration appears. If you select **Yes**, the user information registration is canceled, and you return to the Home screen.  
If you selected **Disagree**, you can still use this service later.
- You can print the displayed information by pressing the **Start** button.

6. On the **Time zone** screen, select the time closest to your region, and then select **Next**

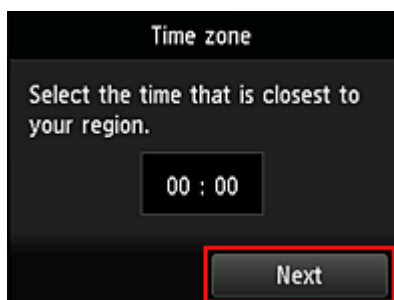

7. In the time zones list, select the region closest to you

For some regions, a screen for applying the daylight saving time setting may appear.

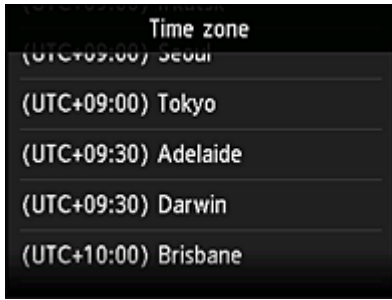

8. When a message appears notifying that the app is now available, select **Apps**

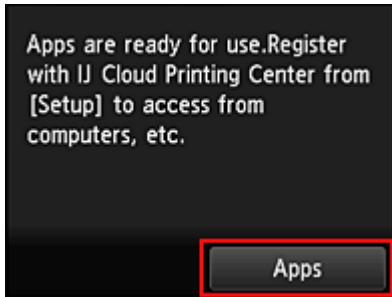

The registration of printer information is completed, and a list of apps is displayed.  
See [here](#) for the description of the apps list screen.

When you complete the registration, you can [add/delete/sort apps](#) and [print photos and documents](#) that have been uploaded.

When you register your printer to [Canon Inkjet Cloud Printing Center](#), you can use PIXMA Cloud Link from your smartphone or tablet device.

## Using PIXMA Cloud Link

This section introduces the photo printing procedure by using CANON iIMAGE GATEWAY as an example.

### »» Important

- The available functions differ depending on the app.
- The printing procedure differs depending on the app.
- You need to get the account and register photo and other data beforehand.
- The following file formats can be printed: jpg, jpeg, pdf, docx, doc, xlsx, xls, pptx, ppt, txt, and rtf. The file formats that can be printed differ depending on the app.
- Before you print, check that printer is on and is connected to the network. Then start.

### »» Note

- You can use CANON iIMAGE GATEWAY to print jpg and jpeg file formats.

1. On the [Main screen](#), select the app to be used
2. Enter the information according to the instructions on the authentication screen, and then select **Log in**



»»» Important

- Some apps may not be fully displayed in the display area. If this is the case, scroll up, down, right, and left to change the display area.

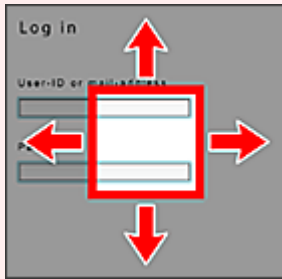

 : Visible area

- The Login screen may vary between apps.
- On the Login screen, just enter the account and password and log in. Otherwise, the operation of the product after the login is not guaranteed.
- After logging in, you may be asked from an external service to agree to use their app. Agree if you are using the app.

3. In the displayed album list, select the album of your choice



4. In the displayed image list, select the image that you want to print, and then select **Next**

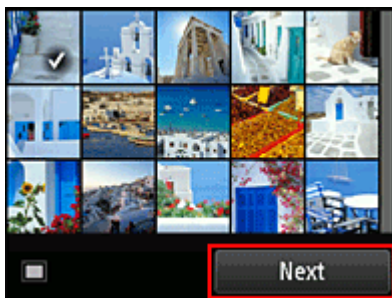

5. Make the necessary print settings, and then select **Color**



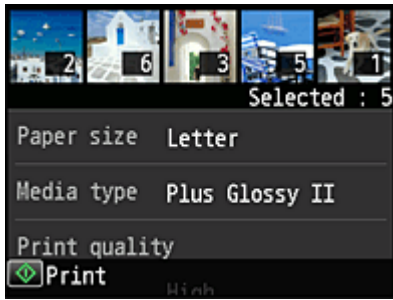

6. A message that indicates the completion of issuing print job appears, and printing starts

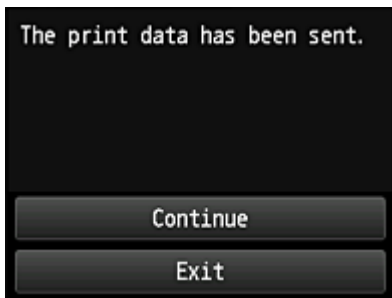

To end the printing, select **Exit**. The screen returns to the apps list screen.

To continue printing, select **Continue**, and perform the operation from Step 3.

### »» Important

- If a print job is not printed within 24 hours after the print job is issued, the print job will expire and cannot be printed.
- With premium apps that limit the number of print jobs, print jobs that cannot be printed due to expiration and other reasons are also included in the print count.

## Cloud troubleshooting

### If you cannot print

Check the following if you cannot print.

- Check that the printer is connected to the Internet.
- Check that the printer is connected to a LAN and the LAN environment is connected to the Internet.
- Check that no error message is displayed on the printer's LCD monitor.

If the problem is not resolved, use the printer driver from your computer to perform the print job and check whether the data can be printed normally on the printer.

If you still cannot print, see the troubleshooting page for your model on the Home of the *Online Manual*.

### »» Note

- With a wireless LAN connection, after the printer is turned on, it may take several minutes before communication is possible. Check that your printer is connected to the wireless network, and wait a while before you start printing.
- If the printer is not turned on or is not connected to the Internet, and consequently a print job is not processed within 24 hours after it was submitted, the print job is automatically canceled. If this happens, check the printer power and the Internet connection, and then re-submit the print job.

Copyright c 1991-2013 Unicode, Inc. All rights reserved. Distributed under the Terms of Use in <http://www.unicode.org/copyright.html>.

This software is based in part on the work of the Independent JPEG Group.

#### THE BASIC LIBRARY FUNCTIONS

Written by: Philip Hazel

Email local part: ph10

Email domain: cam.ac.uk

University of Cambridge Computing Service, Cambridge, England.

Copyright (c) 1997-2008 University of Cambridge All rights reserved.

#### THE "BSD" LICENCE

Redistribution and use in source and binary forms, with or without modification, are permitted provided that the following conditions are met:

- \* Redistributions of source code must retain the above copyright notice, this list of conditions and the following disclaimer.
- \* Redistributions in binary form must reproduce the above copyright notice, this list of conditions and the following disclaimer in the documentation and/or other materials provided with the distribution.
- \* Neither the name of the University of Cambridge nor the name of Google Inc. nor the names of their contributors may be used to endorse or promote products derived from this software without specific prior written permission.

THIS SOFTWARE IS PROVIDED BY THE COPYRIGHT HOLDERS AND CONTRIBUTORS "AS IS" AND ANY EXPRESS OR IMPLIED WARRANTIES, INCLUDING, BUT NOT LIMITED TO, THE IMPLIED WARRANTIES OF MERCHANTABILITY AND FITNESS FOR A PARTICULAR PURPOSE ARE DISCLAIMED. IN NO EVENT SHALL THE COPYRIGHT OWNER OR CONTRIBUTORS BE LIABLE FOR ANY DIRECT, INDIRECT, INCIDENTAL, SPECIAL, EXEMPLARY, OR CONSEQUENTIAL DAMAGES (INCLUDING, BUT NOT LIMITED TO, PROCUREMENT OF SUBSTITUTE GOODS OR SERVICES; LOSS OF USE, DATA, OR PROFITS; OR BUSINESS INTERRUPTION) HOWEVER CAUSED AND ON ANY THEORY OF LIABILITY, WHETHER IN CONTRACT, STRICT LIABILITY, OR TORT (INCLUDING NEGLIGENCE OR OTHERWISE) ARISING IN ANY WAY OUT OF THE USE OF THIS SOFTWARE, EVEN IF ADVISED OF THE POSSIBILITY OF SUCH DAMAGE.

# Application Management

This section explains how to [add](#), [delete](#), and [sort](#) apps.

## Add apps

You can add your favorite apps to the printer.  
Follow the steps described below to add apps.

1. From the printer home screen, select  **Cloud**

2. On the cloud's Main screen, select **Add/delete**

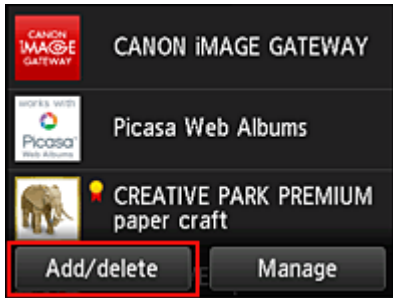

3. Select **Register apps**

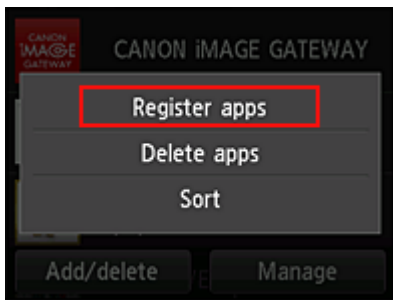

4. On the list, select the category of the app

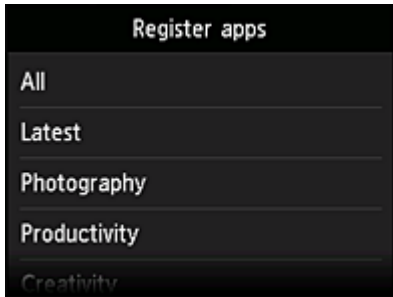

5. From the displayed apps list, select the app that you want to register

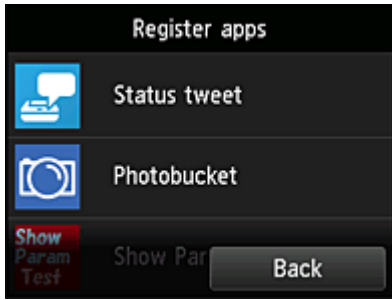

### ▶▶▶ Note

- Description of displayed icons  
 : Can be used with genuine Canon ink.

## 6. Select **Register**

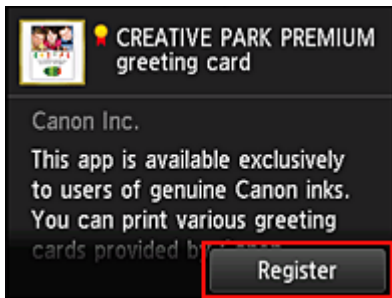

The registration is completed and the app is added to the apps list.

To register another app, repeat the procedure from step 5.

To end the app registration, select **Back** and return to the cloud's Main screen.

### ▶▶▶ Important

- Some apps may require you to have an account before using the app. If this is the case, get the account beforehand.

## Delete apps

You can delete unnecessary apps from the apps list.

Follow the steps described below to delete apps.

1. From the printer home screen, select  **Cloud**
2. On the cloud's Main screen, select **Add/delete**

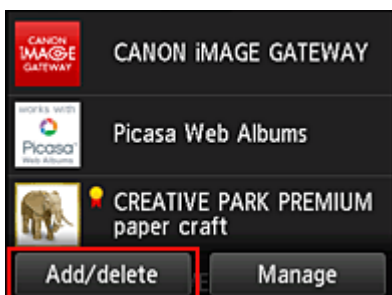

### 3. Select **Delete registered apps**

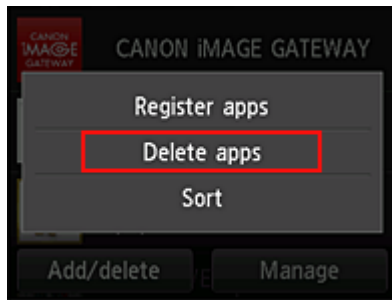

### 4. From the apps list, select the app that you want to delete

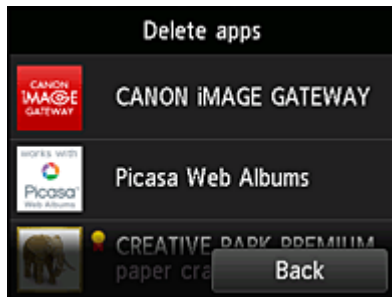

#### ▶▶▶ Note

- Description of displayed icons



: Cannot be used because it is not yet released or not available in your region.



: Can be used with genuine Canon ink.

### 5. Select **Delete**

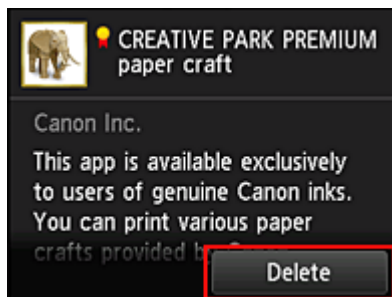

When the deletion is finished, the app will be deleted from the apps list on the main screen.

To delete another app, repeat the procedure from step 4.

To end the app deletion, select **Back** and return to the cloud's Main screen.

## Sort apps

You can sort apps displayed on the apps list.

Follow the steps described below to sort apps.



1. From the printer home screen, select **Cloud**

2. On the cloud's Main screen, select **Add/delete**

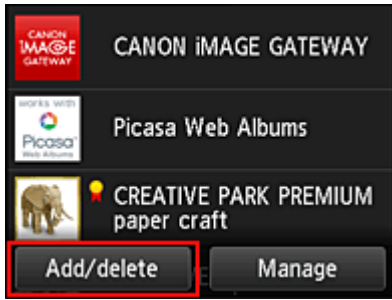

3. Select **Sort**

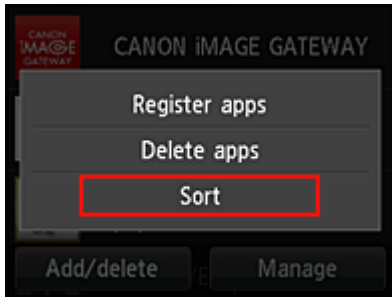

4. On the apps list, select the app that you want to sort

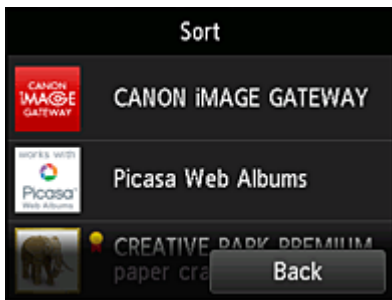

▶▶▶ **Note**

- Description of displayed icons
  - ⊘ : Cannot be used because it is not yet released or not available in your region.
  - 📌 : Can be used with genuine Canon ink.

5. Use ▲ / ▼ buttons to move the app

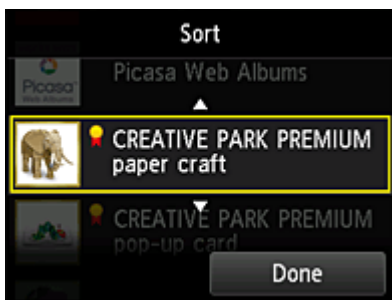

6. Select **Done**

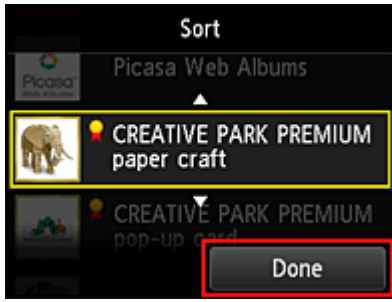

Sorting is complete.

To continue the sorting, repeat the procedure from step 4.

To end the sorting, select **Back** and return to the cloud's Main screen.

# Cloud Windows

This section describes the Main screen of **Cloud** and the services available on the Main screen.

- ➔ [About the Main screen](#)
- ➔ [Register apps](#)
- ➔ [Delete registered apps](#)
- ➔ [Sort](#)
- ➔ [Log out of all apps](#)
- ➔ [License agreement/Privacy statement](#)
- ➔ [Settings](#)

## About the Main screen

When using the **Cloud** function, follow the steps described below first and display the Main screen.

1. Check that the printer is connected to the Internet

2. From the printer home screen, select  **Cloud**

The cloud's Main screen appears.

You can use areas shown below to perform various functions, including adding, starting, and managing apps and printing photos and documents.



- (1) [Display area](#)
- (2) [Add/delete button](#)
- (3) [Manage button](#)

### »»» Important

- Some apps may require you to have an account before using the app. If this is the case, get the account beforehand.
- After selecting the app, some apps may not be fully displayed in the display area. If this is the case, scroll up, down, right, and left to change the display area.

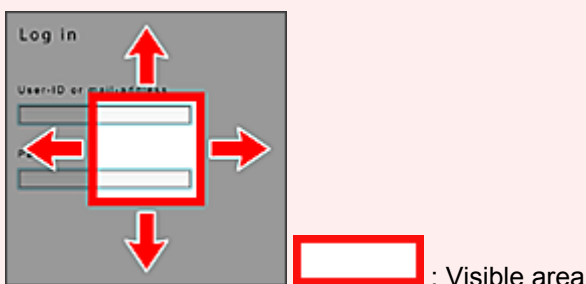



- The app is not displayed if it is not yet released, or if the language not available in your region is selected in the display language setting.

## (1) Display area

The display changes based on the menu you select.

Immediately after starting the cloud, registered apps appear on the list.

To start an app, select the app that you want to use on the list.

### ▶▶▶ Note

- Description of displayed icons



: Cannot be used because it is not yet released or not available in your region.



: Can be used with genuine Canon ink.

## (2) Add/delete button

Use this button to add, delete, and sort apps.

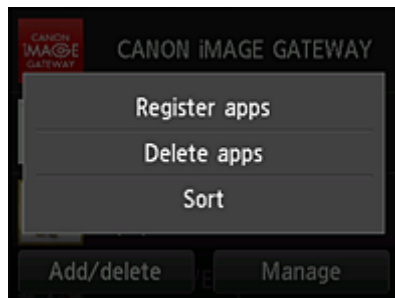

### Register apps

Select this to add your favorite apps.

- ➔ [See here for details on how to add apps](#)

### Delete apps

Select this to delete registered apps.

- ➔ [See here for details on how to delete apps](#)

### Sort

Select this to sort the apps list.

- ➔ [See here for details on how to sort the apps list](#)

## (3) Manage button

Use this button to log out of an app, show the license agreement and privacy statement, and set the time zone.

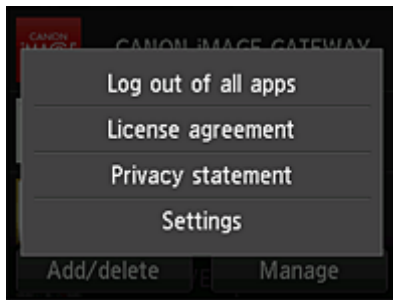

## Log out of all apps

You can log out at the same time from all apps that you are logged into.

### »»» Note

- Some apps may not allow you to log out when you are logged on. If you want to log in with a different account, you need to use this function to log out first.
- Once you log out, you need to log in again. You may lose the settings with some apps.

## License agreement / Privacy statement

This shows the license agreement and privacy statement.  
Press the **Start** button to print the displayed information.

## Settings

Select this to set the time zone.

Select your region on the list. For some regions, you can set whether or not to apply the daylight saving time setting.

### »»» Important

- If you cannot find your region on the list, select the one closest to your region.

# Using Canon Inkjet Cloud Printing Center

Canon Inkjet Cloud Printing Center is a service that links with the cloud function of the printer and allows you to perform operations such as registering and managing apps from your smartphone or tablet device, and checking the print status, print error, and ink status of the printer. You can also print photos and documents from your apps.

If you are using this service from your computer, you can manage the apps.

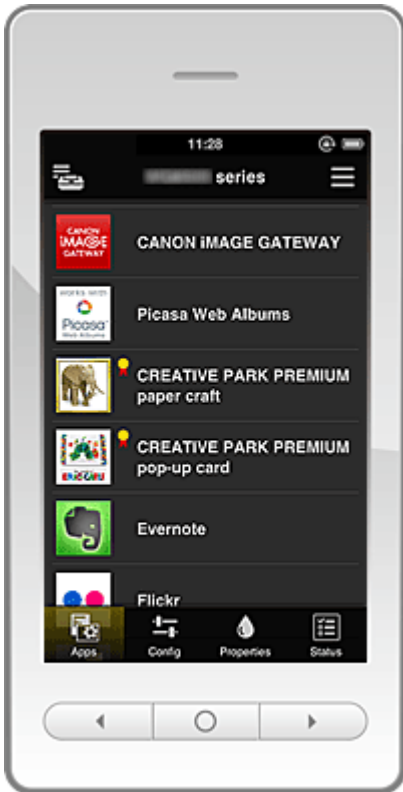

## ▶▶▶ Important

- The screen display may change without prior notice.

- ➔ [Before using Canon Inkjet Cloud Printing Center](#)
- ➔ [Preparations before using Canon Inkjet Cloud Printing Center](#)
- ➔ [Using Canon Inkjet Cloud Printing Center](#)
- ➔ [Troubleshooting Canon Inkjet Cloud Printing Center](#)

## Before using Canon Inkjet Cloud Printing Center

First, check your environment.

- **Printer specification**

Check that Canon Inkjet Cloud Printing Center supports the printer.

- **Network environment**

The printer must be connected to a LAN and to the Internet.

## ▶▶▶ Important

- The user will bear the cost of Internet access.

- **Printer software (firmware) version**

If the printer's firmware version is earlier than Ver. 2.000, you need to update the firmware. Refer to "Firmware update" for your model from the Home of the *Online Manual* for details.

**»» Important**

- When you update the firmware of this product, the displayed screens, the operation procedures, and the functions may change.
- If you register a photo-sharing service to your printer and then later update the printer firmware, the photo-sharing service will be deregistered. Please perform the account setup again.

- **Operating requirements**

See [here](#) for the operating requirements for computers, smartphones, and tablet device.

**»» Important**

- This service may not be available in certain countries or regions. Also even if the service is available, there are apps that cannot be used in certain regions.



## Preparations before using Canon Inkjet Cloud Printing Center

To use the Canon Inkjet Cloud Printing Center, you need to follow the steps described below and register the user information.



### Print registration information from the printer

1. Check that the printer is connected to the Internet

2. From the home window, select  **Setup** ->  **Web service setup** -> **Web service connection setup** -> **IJ Cloud Printing Center setup** -> **Register with this service**

3. When you are asked to confirm the registration, select **Yes**

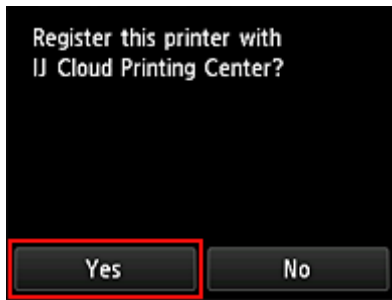

4. Select the language to be used in Print settings



5. Follow the instructions displayed in the window, and print the URL of the authentication site and the **Printer registration ID**

Set A4 size or Letter size plain paper and select **OK**.

The authentication URL and **Printer registration ID** are printed.

#### ▶▶▶ Note

- You will use this printed page in the next step.

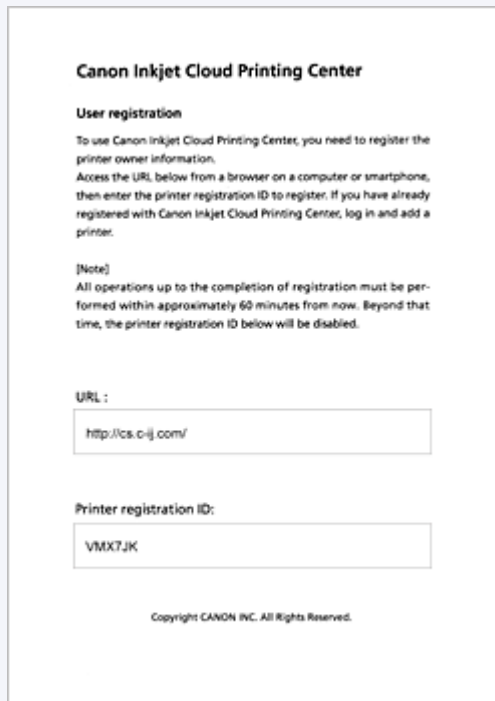

#### ▶▶▶ Important

- The operation to complete the registration should be done within 60 minutes.

## Access the URL on the printed page, and then enter the e-mail address and other necessary information

### »» Important

- Do not use the Back button of the web browser while an operation is processing. The screen may not transition properly.

1. Use the web browser on your PC, smartphone, tablet, or other devices to access the authentication URL

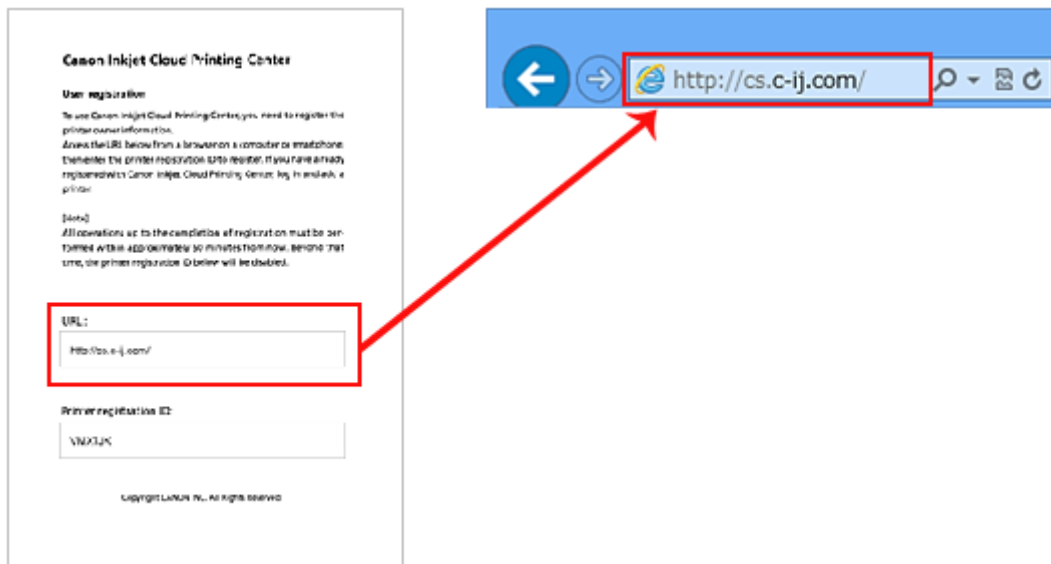

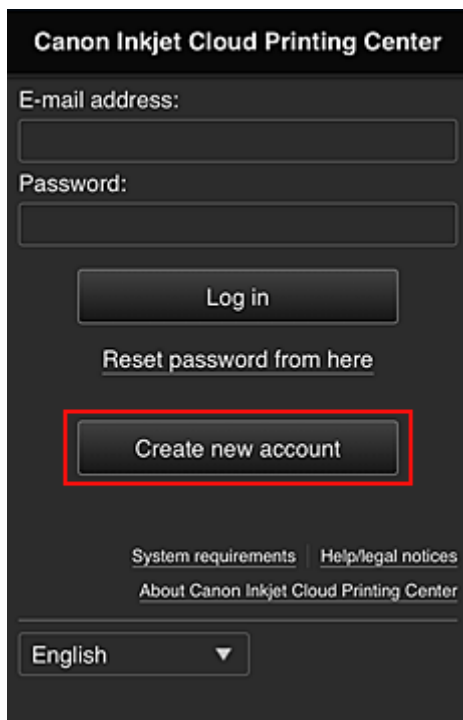

2. On the Login screen, select **Create new account**

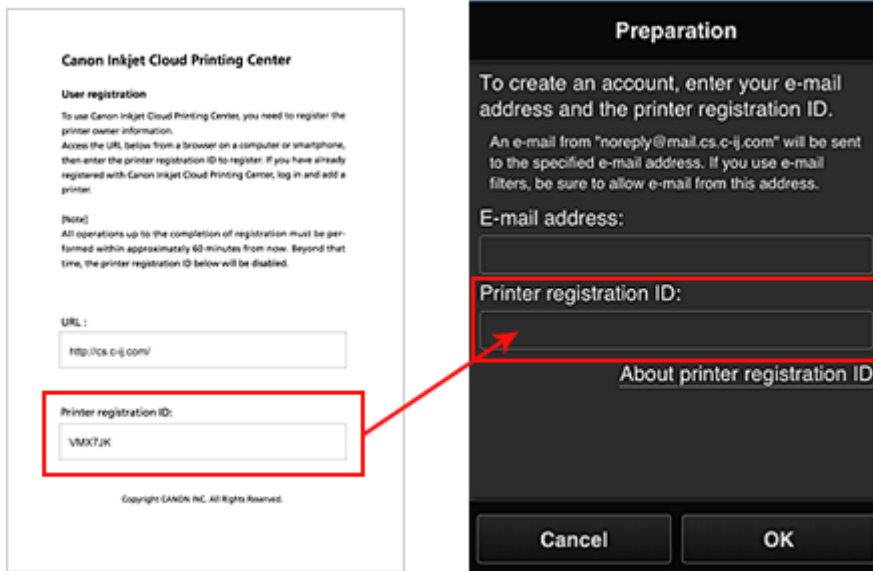

3. Enter the **E-mail address** and **Printer registration ID** of the printer's owner, and then select **OK**



### ►► Important

- There are character restrictions for the e-mail address, as shown below.
  - You can use up to 255 alphanumeric characters consisting of single-byte characters and symbols (!#\$%&'\*+/?^\_{}|~.-@).
  - Multibyte characters cannot be used.  
You will get an error if the e-mail address you enter contains a character that cannot be used.
- If you registered a different e-mail address by mistake, you can cancel the registration by going to the printer's Home screen and selecting  **Setup** ->  **Web service setup** -> **Web service connection setup** -> **IJ Cloud Printing Center setup** -> **Delete from this service**.
- You may not be able to receive the notification if you are using a spam filter. If you have a setting to receive only the e-mails from certain domains, be sure to change the setting to allow receiving e-mails from "noreply@mail.cs.c-ij.com".  
There will be no error display even if you could not receive the e-mail because of the spam filter setting or if you entered an incorrect e-mail address.

4. The registration page URL is sent to the e-mail address entered

## Access the URL in the e-mail, register the information, and complete the user registration

1. When an e-mail with the subject "Information on Canon Inkjet Cloud Printing Center" is sent to the e-mail address that you entered, select the URL
2. In the **License agreement** and **Privacy statement** windows of Canon Inkjet Cloud Printing Center, read the statements, and select **Agree** if you agree

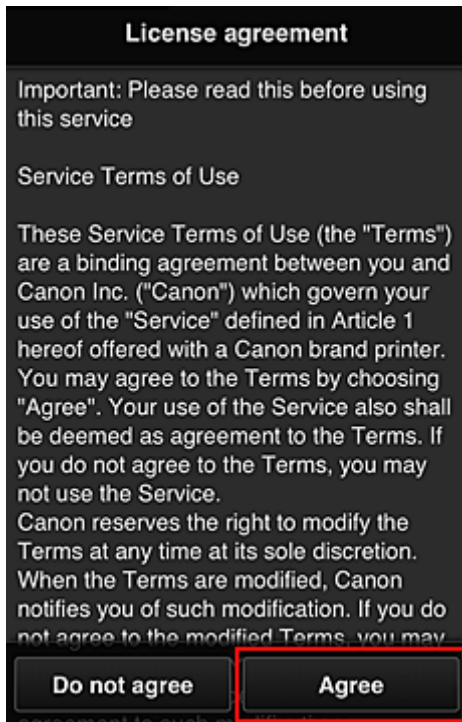

<License agreement>

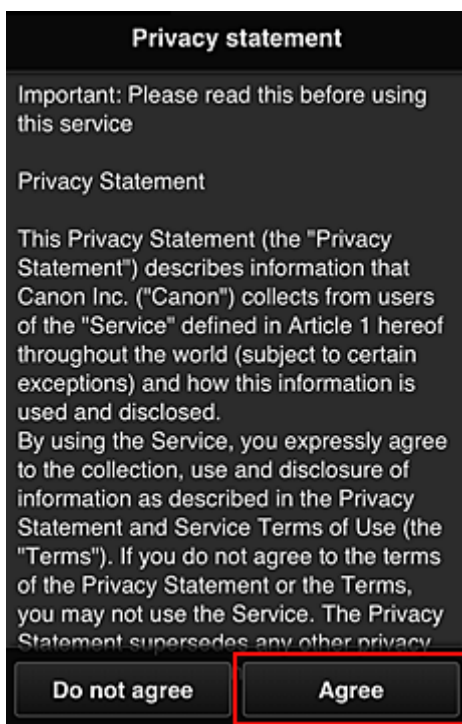

<Privacy statement>

3. Configure required settings on the User information input screen, and then select **OK**



**Register user info**

Time zone:  
(UTC) Coordinated Universal Time ▼

Set a password for logging into this service.

Password:  
[Input field]

Password (Confirmation):  
[Input field]

8 to 32 characters

Cancel OK

#### **Time zone**

Select your region on the list. If you cannot find your region on the list, select the one closest to your region.

#### **Apply daylight saving time**

This appears only when there is a daylight saving time in the time zone that you selected. Select whether or not to apply the daylight saving time.

#### **Password**

Enter the login password for Canon Inkjet Cloud Printing Center.

#### **Password (Confirmation)**

Enter the password again for confirmation.

#### **Important**

- There are character restrictions for the password, as shown below.
  - The password needs to be between 8 and 32 characters long, using single-byte alphanumeric characters and symbols (!"#%&'()\*+,-./:;<=>?@[\\]^\_`{|}~). (Alphabets are case-sensitive)

The registration is completed. The registration completed message appears. When you press **OK**, the Login screen appears.

Canon Inkjet Cloud Printing Center

E-mail address:

Password:

Log in

[Reset password from here](#)

Create new account

[System requirements](#) [Help/legal notices](#)  
[About Canon Inkjet Cloud Printing Center](#)

English ▼

Enter the registered e-mail address and password and log in to the Canon Inkjet Cloud Printing Center.

➔ [See here for the details of the Login screen](#)

## Using Canon Inkjet Cloud Printing Center

When the user registration is completed, you can log in to the Canon Inkjet Cloud Printing Center and use the service.

1. From your PC, smartphone, or tablet, access the service login URL (<http://cs.c-ij.com/>)
2. On the Login screen, enter the **E-mail address** and **Password**, and then select **Log in**

### ▶▶▶ Important

- The e-mail address and password are case-sensitive. Make sure the case is correct.

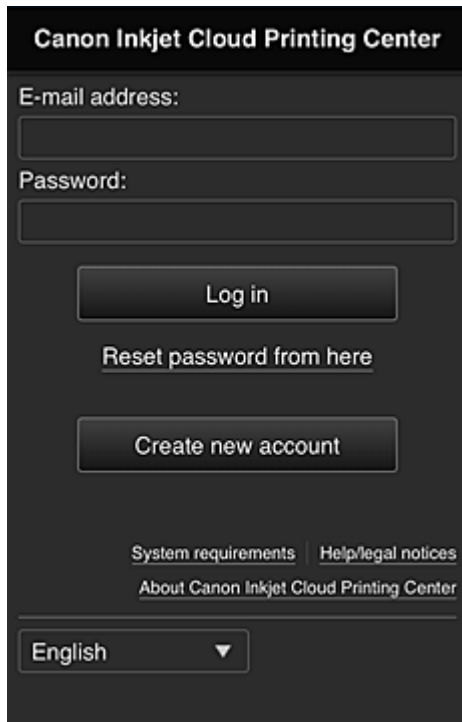

### E-mail address

Enter the e-mail address that you entered in the user registration.

### Password

Enter the password that you entered in the user registration.

## »» Important

- If you fail to log in five straight times, you will not be able to login again for an hour.
- You remain logged in for an hour after the last access.
- If you do not log in for 400 days, you will be unsubscribed from the Canon Inkjet Cloud Printing Center automatically.
- The service may not function properly if you log in from multiple devices at the same time.

After logging in, you can use useful services such as adding/managing apps that work in conjunction with this product's cloud functionality and checking the ink status.

For the description of the screens and operation, see [here](#).

## Printing procedure

This section introduces the photo printing procedure by using CANON iIMAGE GATEWAY as an example.

## »» Important

- The available functions differ depending on the app.
- The printing procedure differs depending on the app.
- You need to get the account and register photo and other data beforehand.
- The following file formats can be printed: jpg, jpeg, pdf, docx, doc, xlsx, xls, pptx, ppt, txt, and rtf. The file formats that can be printed differ depending on the app.
- Before you print, check that printer is on and is connected to the network. Then start.

## »» Note

- You can use CANON iIMAGE GATEWAY to print jpg and jpeg file formats.

1. On the Main screen, select the app to be used
2. Enter the information according to the instructions on the authentication screen, and then select **Log in**

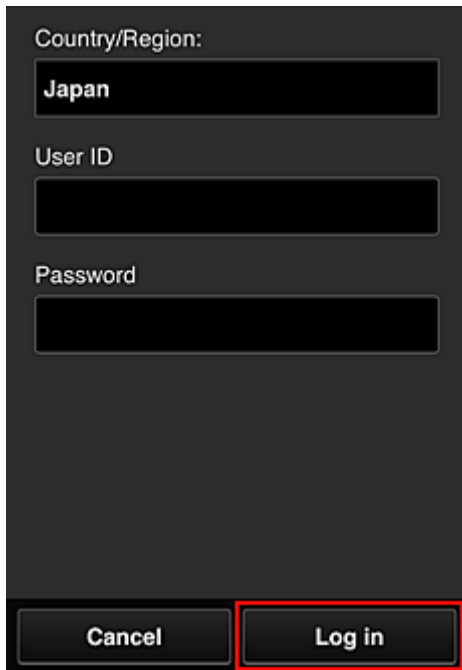

Country/Region:  
Japan

User ID

Password

Cancel Log in

3. In the displayed album list, select the album of your choice

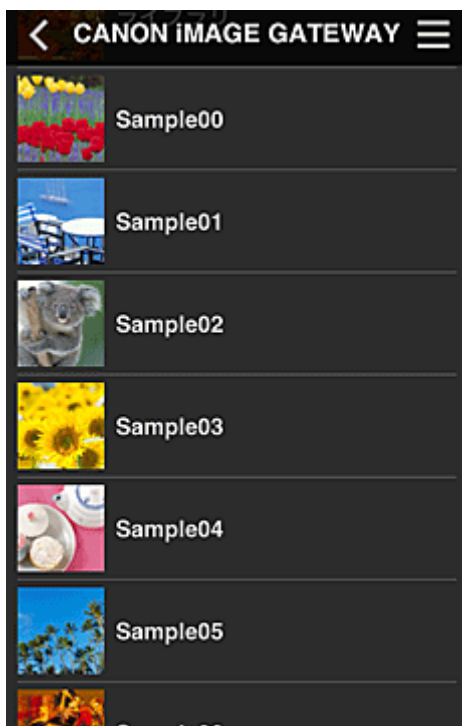

4. In the displayed image list, select the image that you want to print, and then select **Next**



5. Make the necessary print settings, and then select **Print**

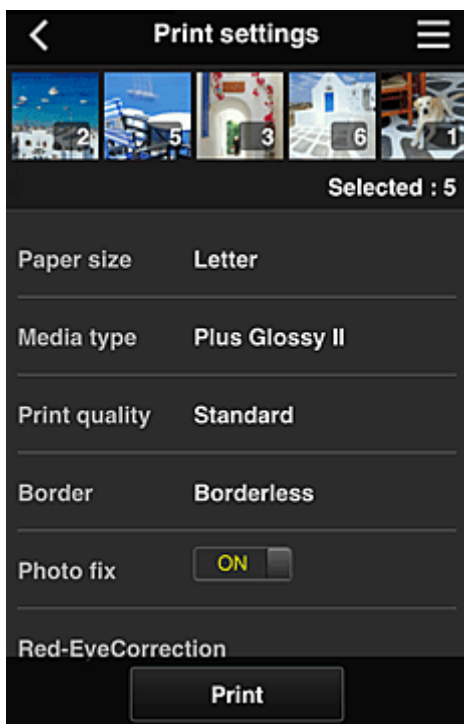

6. A print job completion message appears, and printing starts

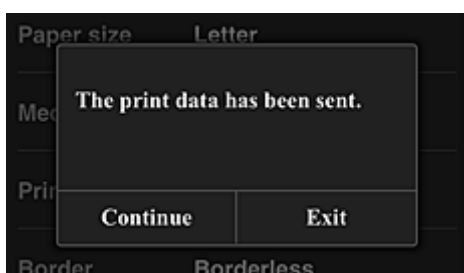

To end the printing, select **Exit** and return to the Apps list screen.

To continue printing, select **Continue** and repeat the procedure from step 3.

### »» Important

- If a print job is not printed within 24 hours after the print job is issued, the print job will expire and cannot be printed.
- With premium apps that limit the number of print jobs, print jobs that expire and cannot be printed are also included in the print count.

## Troubleshooting Canon Inkjet Cloud Printing Center

- ➔ [If an app cannot be installed](#)
- ➔ [If the registered app is not in the Apps list](#)
- ➔ [If the information is not updated when you press the Update button](#)
- ➔ [If you do not receive the registration e-mail](#)
- ➔ [Printing starts on its own even if you do not do anything](#)

### If an app cannot be installed

Check the country or region where the printer was purchased.

If the printer is taken outside the country or region where it was purchased, apps cannot be installed.

For an app that is already installed, if the new region supports that app, you can continue to use it.

However, if you uninstall an app, be aware that you will not be able to install it outside of the country or region where the printer was purchased.

### If the registered app is not in the Apps list

Check the display language of Canon Inkjet Cloud Printing Center.

If the display language is switched to a language that does not support an app, the app will not be displayed in the apps list but will continue to be registered.

If you switch back to the target language of the app, it will be displayed in the apps list and you will be able to start, register, or unregister the app.

### If the information is not updated when you press the Update button

Because the Properties screen requires network connection with this product, the information may not be reflected immediately. Please wait awhile, and then try updating the information again.

If the information is still not updated, then check that the product is connected to the Internet.

### If you do not receive the registration e-mail

### Printing starts on its own even if you do not do anything

You may have entered a different e-mail address during the user registration of Canon Inkjet Cloud Printing Center.



**Setup** ->



**Web service setup** -> **Web service**

**connection setup** -> **IJ Cloud Printing Center setup** -> **Delete from this service** to prevent unauthorized access using this address.

After resetting the printer, repeat the user registration of Canon Inkjet Cloud Printing Center from the beginning.

# Printing Your Printer Registration ID

## ▶▶▶ Important

- **Canon Inkjet Cloud Printing Center**

**Models:**

MG7100 series, MG6400 series, MG5500 series

To add a printer by using Canon Inkjet Cloud Printing Center, you will need a **Printer registration ID**.

From the operation panel of this machine, print the URL of the authentication site and your **Printer registration ID**. The procedure is as follows:

1. Check that the printer is connected to the Internet.

## ▶▶▶ Important

- To use this function, you must connect this printer to the Internet.

2. From the home window, select  **Setup** ->  **Web service setup** -> **Web service connection setup** -> **IJ Cloud Printing Center setup** -> **Register with this service**.

3. In the registration confirmation window, click **Yes**.



4. In the print settings, select the display language.



5. Follow the instructions displayed in the window, and print the URL of the authentication site and your **Printer registration ID**.

Set A4 size or Letter size plain paper and select **OK**.

The authentication site URL and your **Printer registration ID** are printed.

## ▶▶▶ Important

- The operation to complete the registration should be done within 60 minutes.

# Canon Inkjet Cloud Printing Center window

This section describes the Canon Inkjet Cloud Printing Center screens that are displayed on your smartphone, tablet device, or computer.

- ➔ [Description of the Login screen](#)
- ➔ [Description of the Main screen](#)

## Description of the Login screen

This section provides the description of the Login screen of Canon Inkjet Cloud Printing Center.

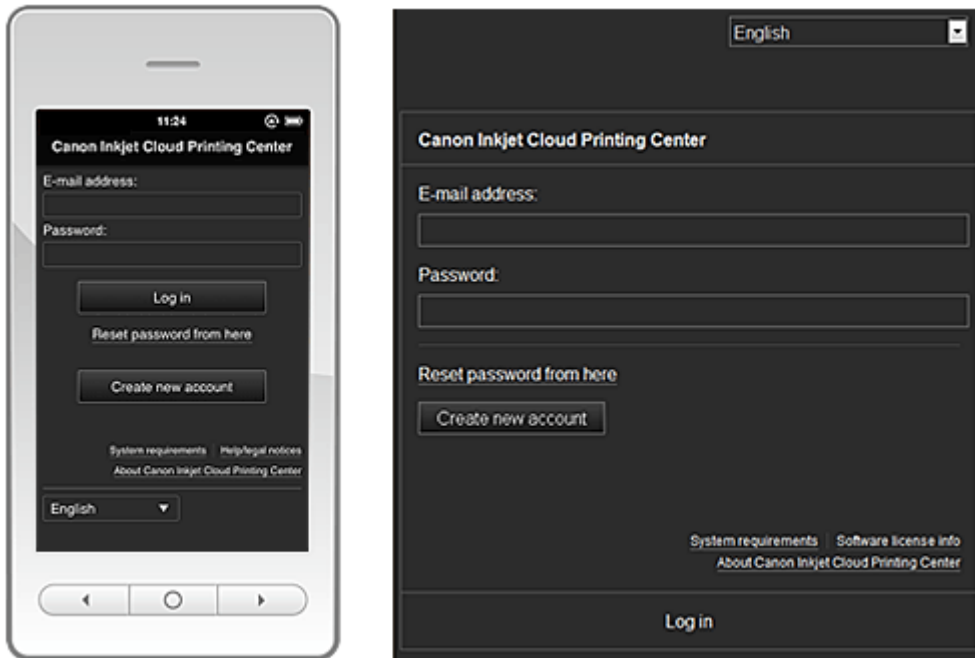

### ➤➤➤ Important

- You have 5 tries to enter your password. If you fail, you will not be able to log in for about the next hour.
- You remain logged in for an hour after the last access.

### Language

Select the language you will be using.  
Then select **Update** to switch the language display.

### E-mail address

Enter the e-mail address that you entered in the user registration.

### Password

Enter the password that you entered in the user registration.

### ➤➤➤ Important

- The e-mail address is case-sensitive. Make sure the case is correct.

### Reset password from here

Select this if you forgot the password.  
Reset your password by following the instructions on the screen.



### Create new account

A new registration will be added to the Canon Inkjet Cloud Printing Center.  
For a new registration, you need the [Printer registration ID](#).

### System requirements

This displays the system requirements for the Canon Inkjet Cloud Printing Center.

### Help/legal notices (smartphone and tablet devices only)

The description of the Canon Inkjet Cloud Printing Center screen and various reminders are displayed.

### Software license info (PC only)

The licensing information of Canon Inkjet Cloud Printing Center is displayed.

### About Canon Inkjet Cloud Printing Center

This displays the descriptions of this service.

## Description of the Main screen

When you log in to the Canon Inkjet Cloud Printing Center, the Main screen appears.

You can use areas shown below to start, add, and manage apps.

If you are using a smartphone or tablet, then you can also print photos and documents.

- ➔ [If you are using a smartphone or tablet](#)
- ➔ [If you are using a PC](#)

### If you are using a smartphone or tablet

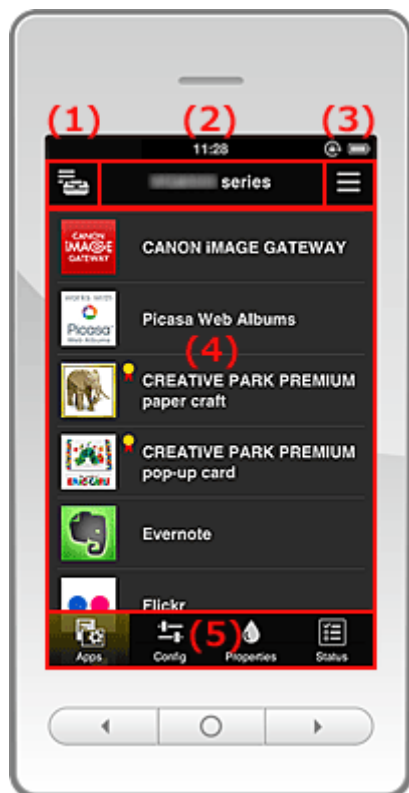

- (1) [Mng. printer button](#)
- (2) [Printer name area](#)
- (3) [Context menu](#)
- (4) [Display area](#)

(5) [Menu area](#)

**(1) Mng. printer button**

Press the **Mng. printer**  button to display the **Mng. printer** screen.

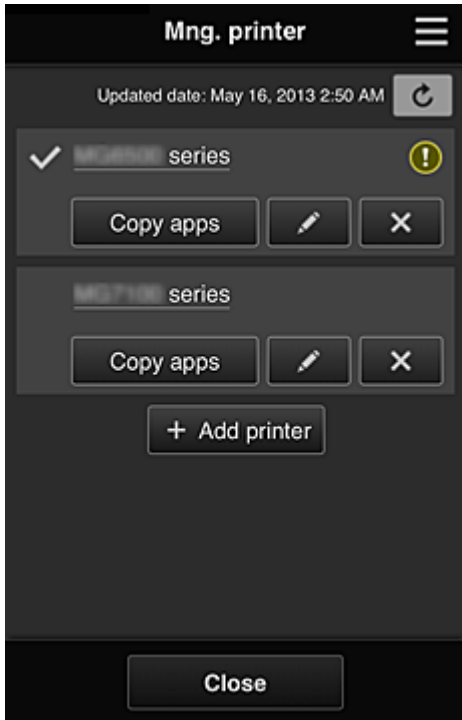

On the **Mng. printer** screen, you can [check the printer information](#) registered in the Canon Inkjet Cloud Printing Center, [change the printer name](#), [delete printers](#), [add printers](#), and [copy apps](#).

• **Check the printer information**

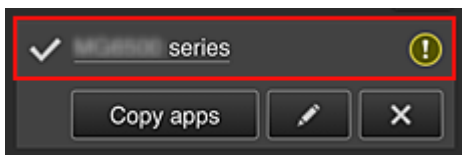

The registered printer name is displayed.

indicates the currently selected printer.

 indicates that an error occurred on the printer.

• **Change the printer name**

When you select , a screen to change the printer name appears. Follow the instructions on the screen to change the name.

• **Delete printers**

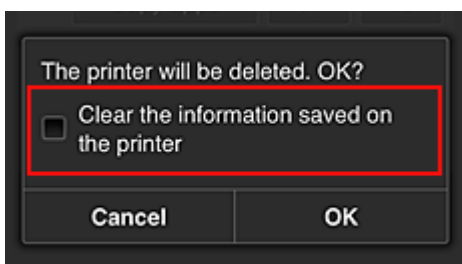

When you select , the printer is deleted from the Canon Inkjet Cloud Printing Center. When transferring the ownership of the printer, select **Clear the information saved on the printer**.

- **Add printers**

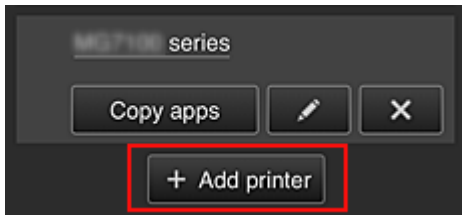

Select this to add printers to be used in the Canon Inkjet Cloud Printing Center. You need a [Printer registration ID](#) to add a printer.

▶▶▶ **Note**

- Up to 16 printers are guaranteed to operate for each e-mail address.

- **Copy apps**

Select this to copy apps added in the selected printer to another printer.

When you select , the screen shown below appears.

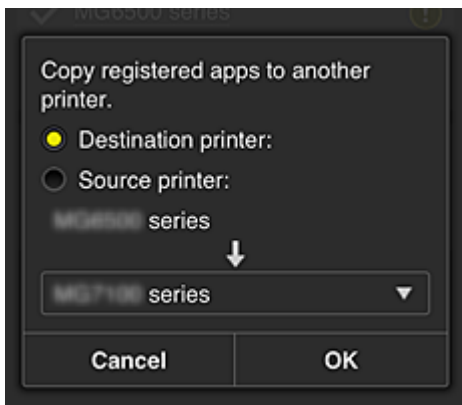

Set the **Destination printer** and the **Source printer**. Then select **OK**.

(2) **Printer name area**

The registered name of the printer selected is displayed.

You can [change the printer name](#) in **Mng. printer**.

(3) **Context menu**

When you select , the context menu appears.

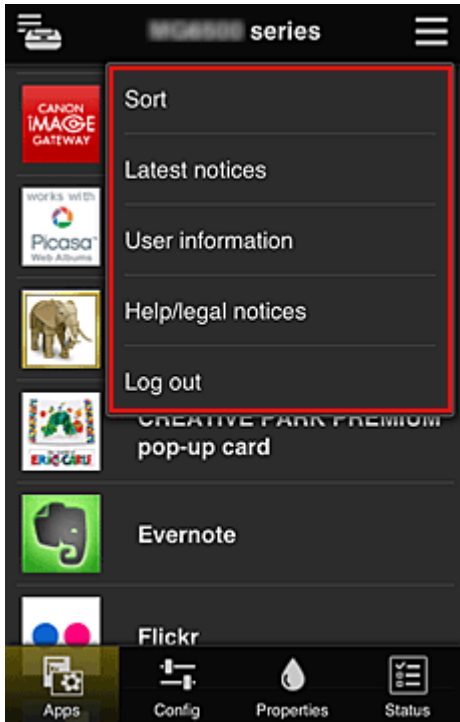

The information displayed depends on the menu currently selected in the menu area.

The  symbol indicates that there is a new unread notice.



- **Sort** **Sort**

This displays the screen to sort registered apps.

You can use the   buttons to change the display order of apps. When you finish sorting, press the **Done** button to confirm the order.

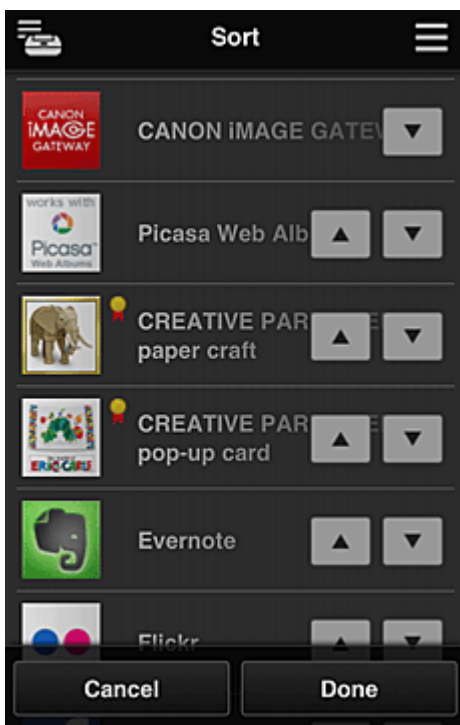

- **Latest notices** **Latest notices**

This displays the latest notices. The  symbol indicates that there is a new unread notice.

- **User information** **User information**

This displays the User information screen.

You can change the registered e-mail address, password, language, time zone, and other settings.

- **Help/legal notices** **Help/legal notices**

The description of the Canon Inkjet Cloud Printing Center screen and various reminders are displayed.

- **Log out** **Log out**

This opens the Log out screen of the Canon Inkjet Cloud Printing Center.

#### (4) Display area

The display changes based on the menu you select.

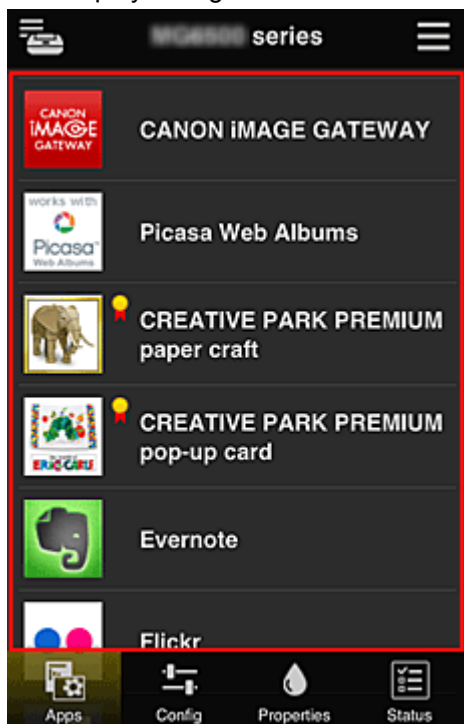

#### (5) Menu area

The following 4 menu buttons are displayed:

-  **Apps**

This displays the list of registered apps in the [Display area](#).

The Sort screen appears when you select [Sort in the context menu](#).

-  **Config**

This displays the Register apps screen in the [Display area](#).

The display can be toggled between **Registered** and **Search apps**.

The **Registered** screen lists registered apps.

You can check the information of these apps or deregister them.

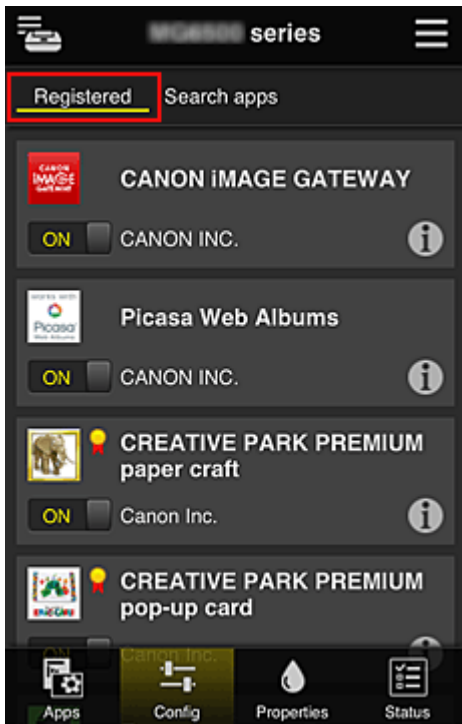

On the **Search apps** screen, the apps that you can register by using the Canon Inkjet Cloud Printing Center are displayed by category.

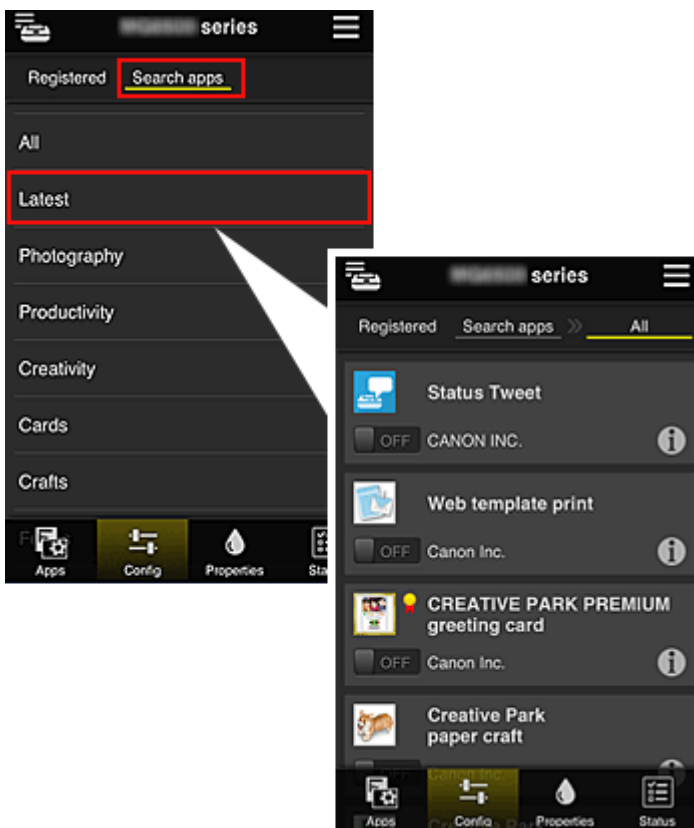

- When you select , the details of the app are displayed.
- When you select , you can choose to register or unregister the app.

### ▶▶▶ Note

- Description of displayed icons



: Cannot be used because it is not yet released or not available in your region.



: Can be used with genuine Canon ink.



## • **Properties**

This screen displays the status of the printer that is currently selected.

You can check how much ink is remaining or details about an error that occurred. You can also access the ink purchasing site and the *Online Manual*.

## »»» **Important**

- The Properties displayed may differ from the actual status at the display time, depending on the printer status.

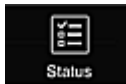

## • **Status**

This screen displays the print status and the print history.

You can check the print status by looking at **Print status list**, and the print history by looking at **Print history**.

You can also cancel print jobs and delete history information.

To cancel or delete a job, select that job and then select **Cancel** or **Delete**.

## If you are using a PC



- (1) [Mng. printer button](#)
- (2) [Printer name area](#)
- (3) [Menu area](#)
- (4) [Notices area](#)
- (5) [Information area](#)
- (6) [Global navigation area](#)
- (7) [Display area](#)

## (1) Mng. printer button

Press the **Mng. printer** button to display the **Mng. printer** screen.

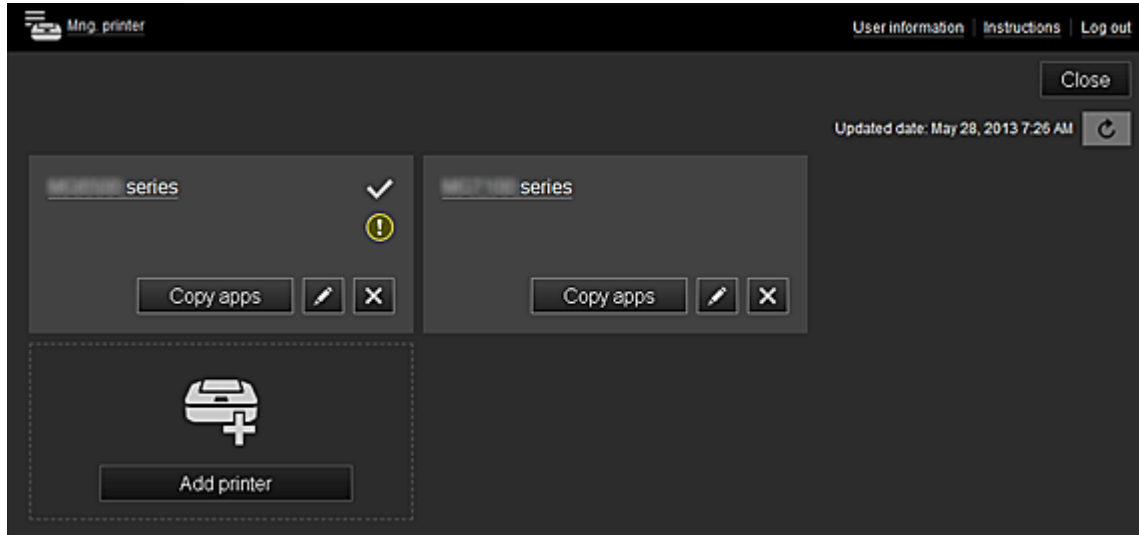

On the **Mng. printer** screen, you can [check the printer information](#) registered in the Canon Inkjet Cloud Printing Center, [display the printer information update date/time](#), [change the printer name](#), [delete printers](#), [add printers](#), and [copy apps](#).

- **Check the printer information**

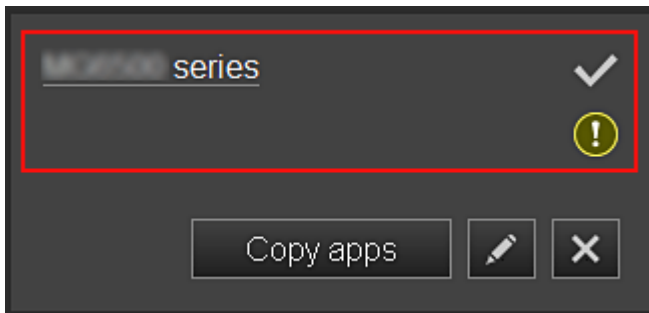

The registered printer name is displayed.

✓ indicates the currently selected printer.

! indicates that an error occurred on the printer.

- **Display update date/time of the printer information**

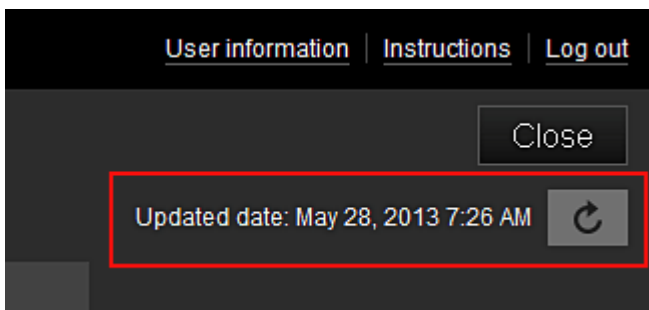

This displays the date and time the printer information was last updated.

↻ refreshes the information.

- **Change the printer name**

When you select , a screen to change the printer name appears. Follow the instructions on the screen to change the name.



- **Delete printers**

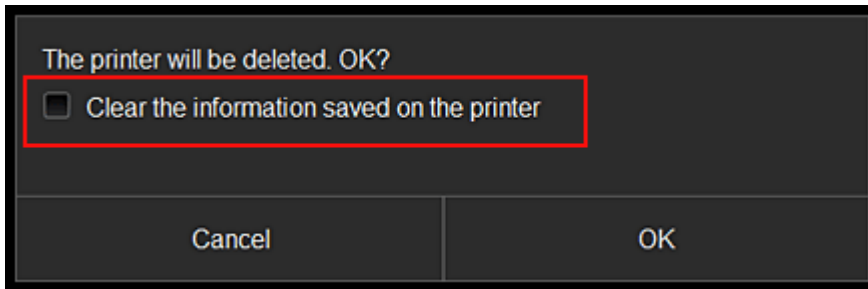

When you select , the printer is deleted from the Canon Inkjet Cloud Printing Center. When transferring the ownership of the printer, select **Clear the information saved on the printer**.

- **Add printers**

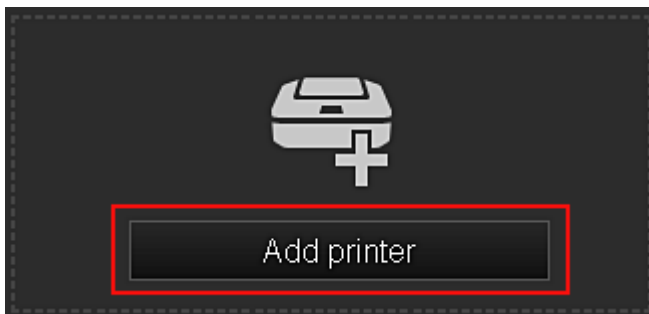

Select this to add printers to be used in the Canon Inkjet Cloud Printing Center. You need a [Printer registration ID](#) to add a printer.

▶▶▶ **Note**

- Up to 16 printers are guaranteed to operate for each e-mail address.

- **Copy apps**

Select this to copy apps added in the selected printer to another printer.

When you select , the screen shown below appears.

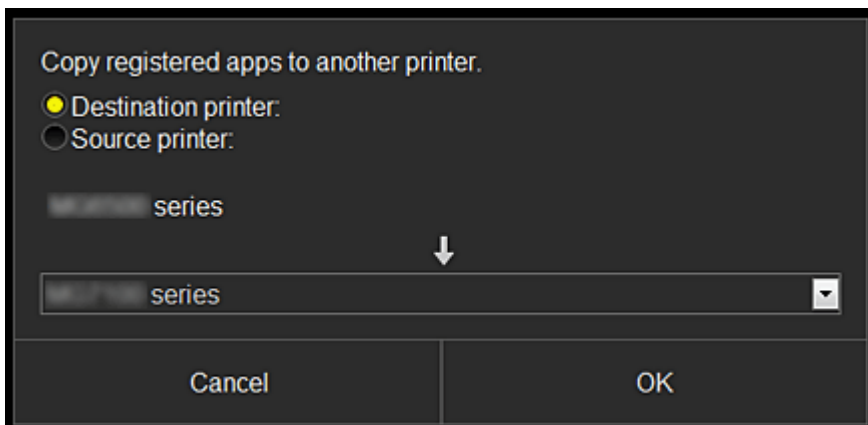

Set the **Destination printer** and the **Source printer**. Then select **OK**.

**(2) Printer name area**

The registered name of the printer selected is displayed.

You can [change the printer name](#) in **Mng. printer**.

### (3) Menu area

The following 4 menu buttons are displayed:

-  **Sort**

This displays the list of registered apps in the [Display area](#).  
Drag the app to change the order.

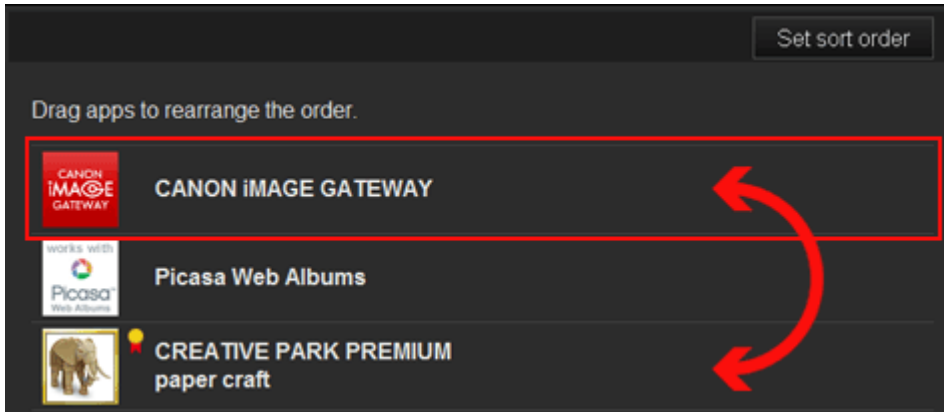

When you finish sorting, press the **Set sort order** button and confirm the order.

-  **Config**

This displays the Register apps screen in the [Display area](#).  
The display can be toggled between **Registered** and **Search apps**.

The **Registered** screen lists registered apps.

You can check the information of these apps or deregister them.

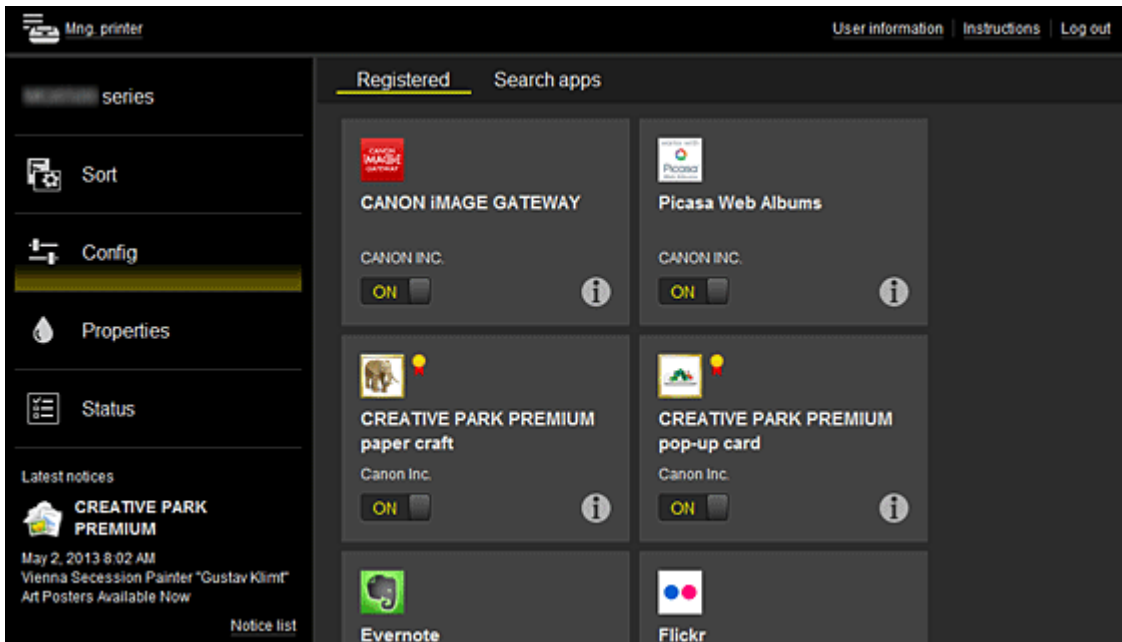

On the **Search apps** screen, the apps that you can register by using the Canon Inkjet Cloud Printing Center are displayed by category.

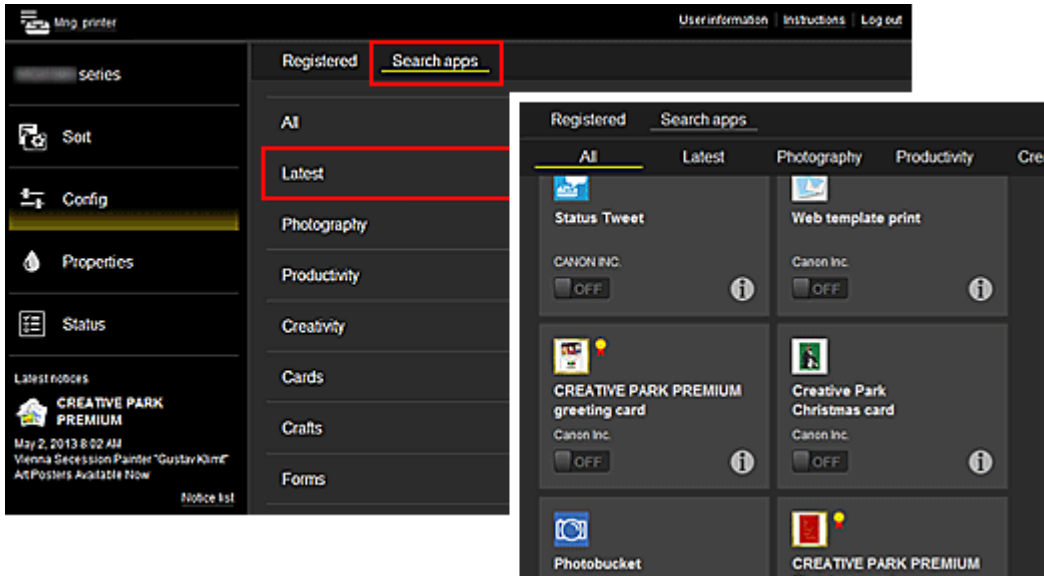

- When you select , the details of the app are displayed.  
When you select / , you can choose to register or unregister the app.

### ▶▶▶ Note

- Description of displayed icons  
 : Cannot be used because it is not yet released or not available in your region.  
 : Can be used with genuine Canon ink.



### • Properties

This screen displays the status of the printer that is currently selected. You can check how much ink is remaining or details about an error that occurred. You can also access the ink purchasing site and the *Online Manual*.

### ▶▶▶ Important

- The Properties displayed may differ from the actual status at the display time, depending on the printer status.

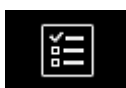

### • Status

This screen displays the print status and the print history. You can check the print status by looking at **Print status list**, and the print history by looking at **Print history**.

You can also cancel print jobs and delete history information.

To cancel or delete a job, select that job and then select **Cancel** or **Delete**.

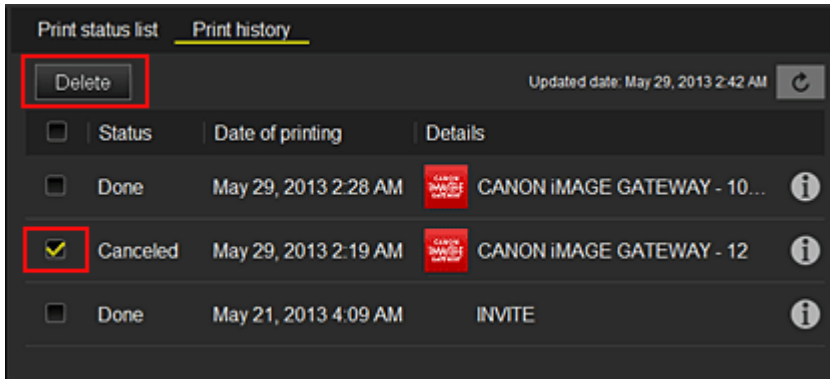

**(4) Notices area**

This displays the latest notice. Nothing is displayed in this area if there is no notice. When you select **Notice list**, you can display up to 40 items.

**(5) Information area**

This display other information, including the privacy statement and other companies' licensing information.

**(6) Global navigation area**

The **User information**, **Instructions**, and **Log out** buttons are displayed. Press the **User information** to change the settings.

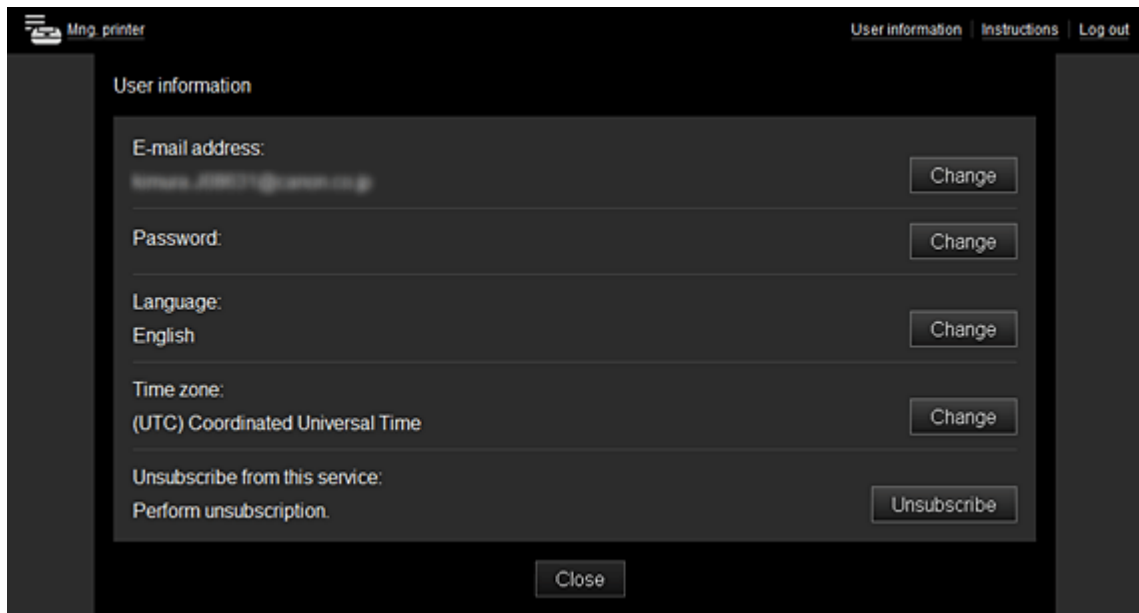

**(7) Display area**

The display changes based on the menu you select.

Mng. printer User information | Instructions | Log out

series Set sort order

Sort

Config

Properties









Status

Latest notices

 **CREATIVE PARK PREMIUM**  
Jun 10, 2013 8:02 AM  
Vienna Secession Painter "Gustav Klimt"  
Art Posters Available Now  
[Notice list](#)

[License agreement](#)  
[Privacy statement](#)  
[Software license info](#)  
Copyright CANON INC. 2013 All Rights Reserved.

Drag apps to rearrange the order.

-  **CANON IMAGE GATEWAY**
-  **Picasa Web Albums**
-  **CREATIVE PARK PREMIUM paper craft**
-  **CREATIVE PARK PREMIUM pop-up card**
-  **Evernote**
-  **Flickr**
-  **Facebook**
-  **Dropbox**
-  **Photos in Tweets**

# Requirements for Canon Inkjet Cloud Printing Center operation

The system requirements for using Canon Inkjet Cloud Printing Center are described below.

Please note these points when you use this service.

## System requirements

### When using a computer

<b>CPU</b>	x86 or x64 1.6 GHz or higher
<b>RAM</b>	2 GB or higher
<b>Monitor display</b>	Resolution 1024 x 768 pixels or higher Number of display colors 24 bits (true-color) or higher

<b>OS</b>	<b>Browser</b>
Windows XP SP3 or later	Internet Explorer 8* Mozilla Firefox 18.0.1 or later Google Chrome 24.0.1312.60 or later
Windows Vista SP1 or later	Internet Explorer 8*, 9 Mozilla Firefox 18.0.1 or later Google Chrome 24.0.1312.60 or later
Windows 7	Internet Explorer 8*, 9, 10 Mozilla Firefox 18.0.1 or later Google Chrome 24.0.1312.60 or later
Windows 8	Internet Explorer 10 (Classic/Metro version) Mozilla Firefox 18.0.1 or later Google Chrome 24.0.1312.60 or later
Mac OS X v.10.4.11-10.8	Safari 5.1-5.3

\* When you use Internet Explorer 8, the web pages may not display correctly.

Canon recommends that you upgrade to Internet Explorer 9 or later. If you are using Windows XP, Canon recommends that you use another browser, such as Mozilla Firefox.

### When using a smartphone or a tablet device

<b>OS</b>	<b>Browser</b>	<b>Resolution</b>
iOS 5.1 or later	OS standard browser	320 x 480 (HVGA) or higher
Android 2.3.3 or later		480 x 800 (HVGA) or higher

- On the browser you are using, enable JavaScript.
- On the browser you are using, enable cookies.
- Canon recommends that you do not use the zoom function or change the font size on your browser. Otherwise, the Canon Inkjet Cloud Printing Center pages may not display correctly.
- Canon recommends that you do not use the translation function of Google Chrome. Otherwise, the Canon Inkjet Cloud Printing Center pages may not display correctly.
- Canon recommends that you do not use a proxy server outside of your country. Otherwise, the service may not be able to determine the correct region.

# Using Remote UI

This service allows you to check printer information and execute utility functions from your computer or smartphone.

You can also use the convenient web services presented by Canon.

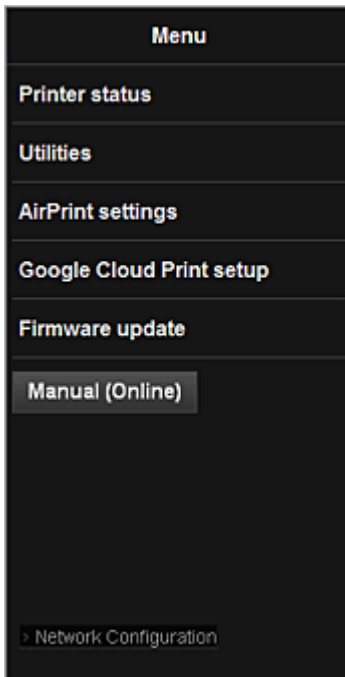

## Checking the printer IP address



To use this service, first check the IP address of this machine from the operation panel of the machine.

### »» Important

- Before you check the IP address of this machine or use the **Remote UI**, make sure that the machine is connected to the LAN and the LAN environment is connected to the Internet. Note that the customer is responsible for paying all Internet connection fees.

1. Check that the machine has been turned on

### If your printer has a LCD monitor

2. From the home window, select  **Setup** ->  **Device settings** -> **LAN settings** -> **Confirm LAN settings** -> **WLAN setting list** or **LAN setting list**. Then from the displayed window, check the IP address.

#### »» Note

- To print the IP address, load one sheet of A4 size or Letter size plain paper. Then from the

home window, select  **Setup** ->  **Device settings** -> **LAN settings** -> **Confirm LAN settings** -> **Print LAN details**, in sequence.

## If your printer does not have a LCD monitor

2. Load one sheet of A4 size or Letter size plain paper
3. Hold down the **Stop** button until the **Alarm** lamp flashes 15 times
4. Release the button

Printing of the network setup information starts.

## Remote UI startup

In the Web browser, directly enter the IPv4 address that you checked from the LCD monitor of the machine. The **Remote UI** starts.

1. From your computer, smartphone, or tablet device, open the Web browser, and enter the following URL:

http:// <Printer IP address>

For "<Printer IP address>" enter the IP address that you checked in "Checking the printer IP address."

2. **Remote UI** startup

The **Remote UI** starts and the top window is displayed.

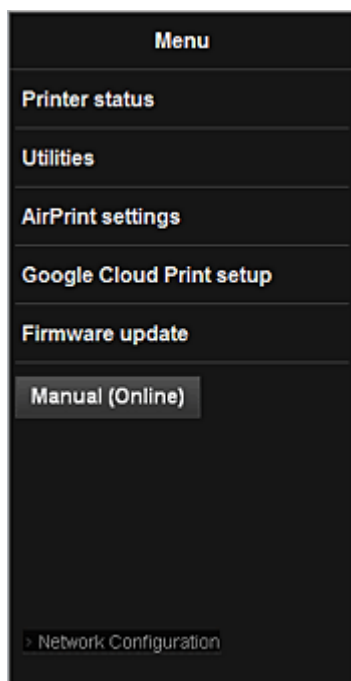

### Printer status

This function displays printer information such as the remaining ink amount, the status, and detailed error information.

You can also connect to the ink purchase site or support page, and use Web Services.

### Utilities

This function allows you to set and execute the machine utility functions such as cleaning.



**AirPrint settings**

This function allows you to specify the Apple AirPrint settings, such as position information.

**Google Cloud Print setup**

This function allows you to register this machine to Google Cloud Print or delete the machine.

**Firmware update**

This function allows you to update the firmware and check version information.

**Manual (Online)**

This function displays the *Online Manual*.

**Network Configuration**

This function displays the network settings.

## Printing from AirPrint Compliant Device

This document explains how to use AirPrint to print wirelessly from your iPad, iPhone and iPod touch to a Canon printer.

AirPrint enables you to print photos, email, Web pages and documents from your Apple device directly to your printer without installing a driver.



### Checking Your Environment

First, check your environment.

- **AirPrint Operation Environment**

To use AirPrint, you will need one of the following Apple devices running the latest version of iOS:

- iPad (all models)
- iPhone (3GS or later)
- iPod touch (3rd generation or later)

- **Network Environment**

The Apple device (iPad, iPhone, or iPod touch) and this machine must be connected to the same Wi-Fi network.

### Printing with AirPrint

1. Check that this machine is turned on and is connected to the LAN.
2. From the app of your Apple device, tap the operation icon to display the menu options.

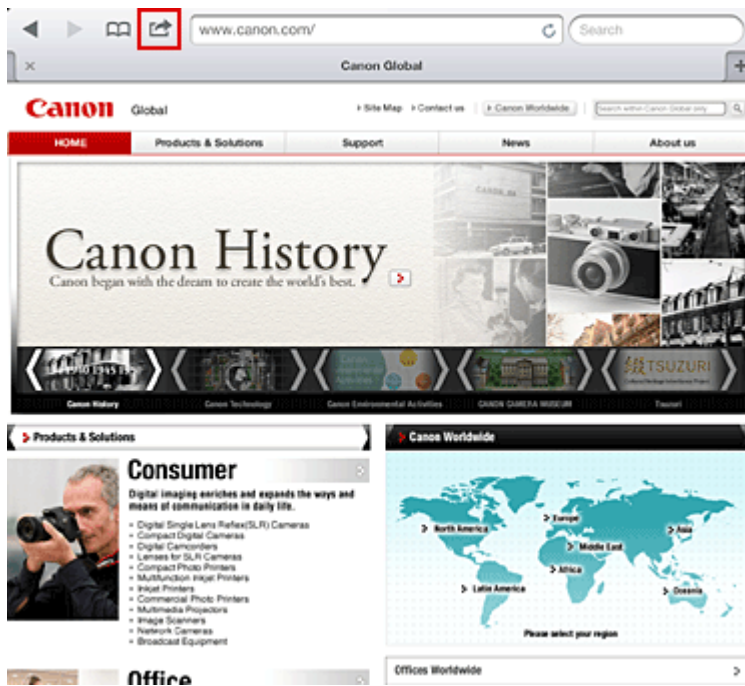

3. From the menu options, tap **Print**.



4. From **Printer Options**, select the model that you are using.

**Important**

- Because some app does not support AirPrint, **Printer Options** may not be displayed. If an app does not let you use printer options, you cannot print from that app.

**Note**

- The printer options differ depending on the app and model you are using. Normally, when you tap **Print** and select a model name, the displayed printer options will include up to the following four options:
  - Printer: Select a model that can be used in your wireless LAN.

- Copies: Select the number of print copies.
- Duplex Printing: If the model supports duplex printing, you can select **On** or **Off**.
- Range: The page range can be used only with specific app and file types (such as PDF files).

5. For **1 Copy**, click **+** or **-** to set the number of required copies.

6. For **Duplex Printing**, click **On** to enable duplex printing or click **Off** to disable the function.

7. When printing a file type that has multiple pages, such as a PDF file, click **Range** and then click **All Pages** or select the range of pages to be printed.

8. Tap the **Print**.

When you execute printing, the printer prints according to the specified settings.

## Paper Size

With AirPrint, the paper size is selected automatically according to the app being used on the Apple device and the region in which AirPrint is used.

When Apple's photo app is used, the default paper size is L size in Japan, and 4"x6" or KG in other countries and regions.

When documents are printed from Apple's Safari app, the default paper size is letter size in the U.S. region, and A4 in Japan and Europe.

### »» Important

- Your app may support different paper sizes.

## Checking the Print Status

During printing, a **Print** icon is displayed in the list of recently used app, and you can use it to check the print progress.

To display the list of latest used app, press the **Home** button on the Apple device twice. The **Print** icon is displayed at the bottom of the **Home** screen.



## Deleting a Print Job

To delete a print job with AirPrint, use one of the following two methods:

- From the machine: If your printer has a LCD monitor, use the operation panel to cancel the print job. If your printer does not have a LCD monitor, press the **Stop** button on the machine to cancel the print job.
- From an Apple device: Press the **Home** button on the Apple device twice. Tap the **Print** icon and display the print job list. Tap the print job to be canceled, and then tap **Cancel Print**.

## AirPrint Troubleshooting

If the document does not print, check the following:

1. Check that the machine power is on. If the machine power is on, turn it off and then back on again, and check whether the issue is resolved.
2. Check that the machine is connected by LAN to the same network subnet as the device on which iOS is installed.
3. Check that the machine has enough paper and ink.
4. If your printer has a LCD monitor, check that no error message is displayed on the LCD monitor.

If the problem persists, use the printer driver on your computer to execute printing and check whether the document can be printed normally on the machine.

If the document cannot be printed, refer to the *Online Manual* for your model.

**»» Note**

- After you turn on the machine, it may take few minutes before the machine can communicate through a wireless LAN connection. Confirm that the machine is connected to the wireless LAN, and then try printing.
- If Bonjour on the machine is disabled, AirPrint cannot be used. Check the LAN settings on the machine, and enable Bonjour.

**»» Note**

- The windows used in the explanations may differ from those displayed by your Apple product or app.

## How to Use Print from E-mail

**Print from E-mail** allows you to print attachment files easily. You only attach a picture or a document from your computer or smartphone and send the e-mail with the attached file.

You can print simply from outside like a travel destination. Also, your family or friends can print by registering beforehand.

You can use **Print from E-mail** on any Canon printer that supports the service.



## Checking Your Environment

First, check your environment.

- **Network environment**

This product needs to be connected to a LAN with an Internet connection.

### ►► Important

- The user will bear the cost of Internet access.
- This function may not be available in some countries/regions.
- Depending on your printer model, this function may not be available.

- **Printer software (firmware) version**

If the printer's firmware version is earlier than Ver. 2.000, you need to update the firmware.

You can execute firmware update from **Remote UI** or from your printer.

To execute the update from **Remote UI**, refer to the [Remote UI usage instructions](#).

To execute the update from your printer, go to the *Online Manual* home page, and refer to the "Firmware Update" document for your printer model.

## Preparing to use Print from E-mail

To use **Print from E-mail**, you need to register the printer by entering information about the printer's owner.



1. Print the printer registration page's URL and the PIN code
2. Access the URL and enter the owner's e-mail address and other required information
3. Check if an e-mail has been sent to the e-mail address you entered
4. Access the URL provided in the e-mail and complete the printer registration process

### »» Note

- The e-mail address that appears on the screen when you have finished registering is the e-mail address that will be used just for the **Print from E-mail** function.

➔ [For details about the registration procedure, see here](#)

## Printing from Your Computer or Smartphone

1. Prepare a file that you want to print

The file format, number of files, and file size that this printing function supports are provided below.

Supported File Formats

- Adobe PDF files
- JPEG files

### »» Important

- Only files that are attached to e-mail can be printed. E-mail messages cannot be printed.
- Encrypted Adobe PDF files, password-protected files, and files that are set to print disabled cannot be printed.
- Files that are attached as compressed files cannot be printed.
- Files other than Adobe PDF files and JPEG files cannot be printed.

Supported Number of Files and File Sizes

- Up to 10 attachment files can be printed.
- The maximum size of an e-mail with attachment files is 5 MB.



### »» Note



- The size of an e-mail is determined based on the size of the entire transmission file, including the e-mail message and the header.  
Therefore sometimes an attachment file cannot be printed even if the size of the attachment file is less than 5 MB.
- If the size of an attached JPEG file is less than 10 KB, the file cannot be printed.

2. Attach a file that you want to print from your PC or smartphone to the e-mail and send it to the e-mail address for printing

To check the printer address, perform one of the following operations from the operation panel of this machine:



- From the operation panel of this machine, display the home window and select  **Setup** ->  **Web service setup** -> **Web service connection setup** -> **Print from E-mail setup** -> **Check address for printing.**

- From the operation panel of this machine, select  **Web service** ->  **Web service setup** -> **Cloud settings** -> **Print from E-mail setup** -> **Check address for printing.**

### »» Important

- You will not be able to use the service during periods when the service is undergoing maintenance.

## Use the Service With More Than One Person

To allow multiple users to use this function, register users (other than the printer's owner) as members.

1. The printer's owner uses his/her PC or smartphone to access the service's login URL (<https://pr.mp.c-ij.com/po>) and logs in
2. Select the printer name that you want to add the member. Click **Member Settings** -> **Add** to enter the member's e-mail address, and click **Register**  
A URL of the member registration page is sent to the e-mail address of the newly registered member.

3. Registered member accesses to the URL that is included in the e-mail, and complete the registration

You can use this service from registered e-mail address.

### »» Note

- You can register up to 500 members.

## Print from E-mail Troubleshooting

- ➔ [The Document Does Not Print](#)
- ➔ [If You Cannot Register to the Service or Delete the Service](#)
- ➔ [If You Cannot Print after the Printer Is Repaired](#)

## The Document Does Not Print

If the document does not print, check the following:



- Check that the printer power is on.  
If the printer power is on, turn it off and then back on again, and check whether the issue is resolved.
- Check that the printer is connected to the network.
- Check that the printer is connected to a LAN and the LAN has an Internet connection.
- Look at the printer LCD monitor and check that no error message is displayed.  
If the problem persists, use the printer driver on your computer to execute printing and check whether



the document can be printed normally on the printer.

If the document cannot be printed, refer to the on-screen manual (operating instructions) that comes with the printer.

- Check that the file attached to the e-mail is a Adobe PDF file or an JPEG file.
- Check whether the e-mail address of the send destination is correct.

To check the printer address, perform one of the following operations from the operation panel of this machine:

- From the operation panel of this machine, display the home window and select  **Setup** ->  **Web service setup** -> **Web service connection setup** -> **Print from E-mail setup** -> **Check address for printing**.

- From the operation panel of this machine, select  **Web service** ->  **Web service setup** -> **Cloud settings** -> **Print from E-mail setup** -> **Check address for printing**.
- Check that the user's e-mail address for using this service is registered.  
If you want to check the error details, the printer owner have to access the login URL (<https://pr.mp.c-ij.com/po>).
- In the **Print Status** screen, click **Go to Print History Screen** and check the history of jobs that were sent. You can check the error details.  
If you want to check the error details, the printer owner have to access the login URL (<https://pr.mp.c-ij.com/po>).

### ▶▶▶ Note

- For a wireless LAN connection, after the printer is turned on, it may take a few minutes before communication becomes possible. Confirm that your printer is connected to the wireless LAN, and then try printing.

## If You Cannot Register to the Service or Delete the Service

### If You Cannot Register to the Service

- If the printer operation panel display the message "Failed to register with "Print from E-mail".", the registration to **Print from E-mail** may not have been completed in time. Select **OK** to release the error, and start over again from the beginning.
- Check that the firmware version of the printer has been updated.



### If You Do Not Receive the URL to Complete the Registration by E-mail

- An incorrect e-mail address may have been entered. Wait about 30 minutes, and operate the printer operation panel to print the printer registration URL and PIN code. Then re-register from the beginning.

### If You Cannot Delete the Service

- If the printer operation panel display the message "Failed to connect to "Print from E-mail". Only the information on the printer was deleted." is displayed, it could be that the registration information on the service could not be deleted even though the **Print from E-mail** information stored on this machine was deleted.  
Select **OK** to release the error, and then access the service's login URL (<https://pr.mp.c-ij.com/po>) to delete the registration information.

- If the **Print from E-mail** information stored on this printer could not be deleted even though the registration information on the service was deleted, delete the registration information from **Deregistration of Registered Printer(s)** by performing one of the following operations:

- From the operation panel of this machine, display the home window and select  **Setup** ->  **Web service setup** -> **Web service connection setup** -> **Print from E-mail setup** -> **Deregistration of Registered Printer(s)**.
- From the operation panel of this machine, select  **Web service** ->  **Web service setup** -> **Cloud settings** -> **Print from E-mail setup** -> **Deregistration of Registered Printer(s)**.

## If You Cannot Print after the Printer Is Repaired

Re-registering the printer and the printer owner

- When the printer is repaired, all of the registered information is deleted and **Print from E-mail** can no longer be used.  
If you want to use this service again, you must re-register the printer and the printer owner.  
For information about the re-registration procedure, see "[Preparing to Use Print from E-mail](#)".  
Even if users other than the owner were registered as members, repeat the registration starting from [here](#).

## Trademarks

- Windows is a trademark or registered trademark of Microsoft Corporation in the U.S. and/or other countries.
- Windows Vista is a trademark or registered trademark of Microsoft Corporation in the U.S. and/or other countries.
- Mac OS, Bonjour, iPad, iPhone, iPod touch, and Safari are trademarks of Apple Inc., registered in the U.S. and other countries. AirPrint and the AirPrint logo are trademarks of Apple Inc.
- IOS is a trademark or registered trademark of Cisco in the U.S. and other countries and is used under license.
- All other company names and products mentioned herein may be trademarks or registered trademarks of their respective companies.

## Preparing to Use Print from E-mail

To use this service to print a photo or document, you need to follow the procedure provided below and register the machine.

### Print the Printer Registration Page's URL and the PIN Code

First, print the printer registration page's URL and the PIN code.

Check that there is sufficient amount of ink in the machine, and then print using the machine's operation panel.

1. Check that the machine is connected to the network

#### Important

- This product needs to be connected to a LAN with an Internet connection.

2. From the operation panel of this machine, display the home page and select **Register printer** by performing one of the following operations:

- From the operation panel of this machine, display the home window and select  **Setup** ->



**Web service setup** -> **Web service connection setup** -> **Print from E-mail setup** -> **Register printer**.

- From the operation panel of this machine, display the home window and select  **Web**



**service** -> **Web service setup** -> **Cloud settings** -> **Print from E-mail setup** -> **Register printer**.

3. Follow the instructions on the screen and print the printer registration URL and PIN code

#### Important

- Do not turn off the power on the machine until the registration process is completed. Access the printed URL and log in within 25 minutes.
- If you canceled the registration before it is completed, repeat the procedure from printing the registration information.

### Access the Printed URL and Enter the Owner's E-mail Address and Other Required Information

Next, enter the owner's e-mail address and other required information.

1. Access the printed URL using the PC's web browser, and click **Log In**
2. In the use agreement window, select **Agree**

**»»» Important**

- If you do not select **Agree** in the use agreement window, you will not be able to register as the printer owner.

3. Enter the printer owner's e-mail address, and click **Next**

**»»» Important**

- An e-mail is sent with the required information for completing the registration to the e-mail address entered for the printer's owner.
- If domain-specific reception is set, change the setting so that mail can be received from "info@mp.c-ij.com"

**»»» Note**

- The e-mail address of the printer owner cannot be changed once the printer owner is registered. To change the e-mail address, delete the registration of the registered printer, and re-register the printer owner by using the new e-mail address. In this case, all previously registered information will be deleted.
- The notification is sent automatically to the registered e-mail address when the printing or service maintenance starts.

4. In the **Printer Owner Registration** window, enter the information shown below, and click **Next**

**User Name**

Enter any name.

The name that you enter is displayed at login.

**»»» Important**

- The maximum number of characters that can be entered is 30.

**Language**

Select the language that you are using.

The language that you select is used in notification e-mails such as print start notices.

**Time Zone**

Refer to [this section](#), and select the standard time of the city that is nearest to the region where you live.

**Date/Time Display Format**

Select the format of your choice. The format that you select is applied to the date/time information in the screens and notification e-mails of this service.

**Daylight Saving Time**

This setting is combined with the **Time Zone** setting, and applied to the date/time information in the screens and notification e-mails of this service.

When you select **ON**, 1 hour is added to the **Time Zone** setting when the date/time information is displayed.

5. In the **Printer Registration** window, enter the **Printer Name**, and click **Confirm**

Enter any name that will allow you to identify the printer.

**»»» Important**

- The maximum number of characters that can be entered is 30.

6. In the **Confirm Owner Registration** window, check the registration information, and then click **Register**

A temporary password will be displayed.

**»»» Important**

- The temporary password that appears is not included in the notification e-mail. Be sure to write down the temporary password before closing the screen.

## Check if an E-mail Has Been Sent to the E-mail Address You Entered

A URL is notified to complete the registration to the e-mail address that for the registered printer's owner.

## Access the URL in the E-mail and Complete the Printer Registration

1. Access the URL provided in the e-mail

**»»» Important**

- You have to complete the registration within 30 minutes.

2. Enter the registered e-mail address of the printer's owner, the temporary password, and click **Log In**

3. Set a password of your choice, and click **Register**

When the password setting process is completed, the printer's e-mail address and the service's URL are displayed, and the printer's registration process is completed.

**»»» Important**

- When you enter the password, the following character restrictions apply.
  - Set a password that has 8 or more characters.
  - The characters that you can use are single-byte uppercase letters, single-byte lowercase letters, and single-byte numbers.
  - In the password, combine all of the different types of characters that can be used.
- The displayed printer's e-mail address and the URL of the login page are not sent. Be sure to write down the printer's e-mail address and the URL of the login page before closing the screen.

## Timezone List

<b>(UTC-12:00)</b>	International Date Line West
<b>(UTC-11:00)</b>	Midway Island
<b>(UTC-10:00)</b>	Hawaii
<b>(UTC-09:00)</b>	Alaska
<b>(UTC-08:00)</b>	Tijuana, Baja California, Pacific Time (US & Canada)
<b>(UTC-07:00)</b>	Arizona, Chihuahua, La Paz, Mazatlan, Mountain Time (US & Canada)
<b>(UTC-06:00)</b>	Guadalajara, Mexico City, Monterrey, Saskatchewan, Central America, Central Time (US & Canada)
<b>(UTC-05:00)</b>	Indiana (East), Bogota, Lima, Quito, Eastern Time (US & Canada), Caracas
<b>(UTC-04:00)</b>	Asuncion, Santiago, Georgetown, La Paz, San Juan, Manaus, Atlantic Time (Canada), Newfoundland
<b>(UTC-03:00)</b>	Cayenne, Greenland, Buenos Aires, Brasilia, Montevideo
<b>(UTC-02:00)</b>	Mid-Atlantic
<b>(UTC-01:00)</b>	Azores, Cape Verde Is.
<b>(UTC+00:00)</b>	Casablanca, Dublin, Edinburgh, Lisbon, London, Monrovia, Reykjavik, Coordinated Universal Time
<b>(UTC+01:00)</b>	Amsterdam, Berlin, Bern, Rome, Stockholm, Vienna, Sarajevo, Skopje, Warsaw, Zagreb, Brussels, Copenhagen, Madrid, Paris, Belgrade, Bratislava, Budapest, Ljubljana, Prague, West Central Africa
<b>(UTC+02:00)</b>	Athens, Bucharest, Istanbul, Amman, Windhoek, Jerusalem, Cairo, Harare, Pretoria, Beirut, Helsinki, Kyiv, Riga, Sofia, Tallinn, Vilnius, Minsk
<b>(UTC+03:00)</b>	Kuwait, Riyadh, Tbilisi, Nairobi, Baghdad, Moscow, St. Petersburg, Volgograd, Tehran
<b>(UTC+04:00)</b>	Abu Dhabi, Muscat, Yerevan, Baku, Port Louis, Kabul
<b>(UTC+05:00)</b>	Islamabad, Karachi, Ekaterinburg, Tashkent, Sri Jayawardenepura, Chennai, Kolkata, Mumbai, New Delhi, Kathmandu
<b>(UTC+06:00)</b>	Astana, Dhaka, Almaty, Novosibirsk, Yangon (Rangoon)
<b>(UTC+07:00)</b>	Krasnoyarsk, Bangkok, Hanoi, Jakarta
<b>(UTC+08:00)</b>	Irkutsk, Ulaan Bataar, Kuala Lumpur, Singapore, Perth, Taipei, Beijing, Chongqing, Hong Kong, Urumqi
<b>(UTC+09:00)</b>	Seoul, Yakutsk, Osaka, Sapporo, Tokyo, Adelaide, Darwin
<b>(UTC+10:00)</b>	Vladivostok, Canberra, Melbourne, Sydney, Guam, Port Moresby, Brisbane, Hobart
<b>(UTC+11:00)</b>	Magadan, Solomon Is., New Caledonia
<b>(UTC+12:00)</b>	Auckland, Wellington, Fiji, Marshall Is., Petropavlovsk-Kamchatsky
<b>(UTC+13:00)</b>	Samoa, Nuku'alofa

# Overview of the Machine

- ➔ [Safety Guide](#)
  - ➔ [Safety Precautions](#)
  - ➔ [Regulatory and Safety Information](#)
- ➔ [Main Components and Basic Operations](#)
  - ➔ [Main Components](#)
  - ➔ [About the Power Supply of the Machine](#)
  - ➔ [Using the Operation Panel](#)
- ➔ [Loading Paper / Originals](#)
  - ➔ [Loading Paper](#)
  - ➔ [Placing a Printable Disc](#)
  - ➔ [Loading Originals](#)
  - ➔ [Inserting the Memory Card](#)
- ➔ [Replacing an Ink Tank](#)
  - ➔ [Replacing an Ink Tank](#)
  - ➔ [Checking the Ink Status](#)
- ➔ [Maintenance](#)
  - ➔ [When Printing Becomes Faint or Colors Are Incorrect](#)
  - ➔ [Performing Maintenance from a Computer](#)
  - ➔ [Cleaning the Machine](#)
- ➔ [Changing the Machine Settings](#)
  - ➔ [Changing Machine Settings from Your Computer](#)
  - ➔ [Changing the Machine Settings Using the Operation Panel](#)
  - ➔ [Setting Up the Card Slot as the Memory Card Drive of the Computer](#)
- ➔ [Information about Network Connection](#)
  - ➔ [Useful Information about Network Connection](#)
- ➔ [About Network Communication](#)
  - ➔ [Changing and Confirming Network Settings](#)
  - ➔ [Screens for Network Connection of IJ Network Tool](#)
  - ➔ [Other Screens of IJ Network Tool](#)
  - ➔ [Appendix for Network Communication](#)
- ➔ [Tips for Ensuring Optimal Printing Quality](#)
  - ➔ [Useful Information about Ink](#)
  - ➔ [Key Points to Successful Printing](#)
  - ➔ [Be Sure to Make Paper Settings after Loading Paper](#)
  - ➔ [Canceling a Print Job](#)
  - ➔ [Key to Enjoying Consistent Printing Quality](#)
  - ➔ [Precautions for Safe Transport of the Machine](#)
- ➔ [Legal Limitations on Use of Your Product and Use of Images](#)
- ➔ [Specifications](#)



# Safety Guide

- [Safety Precautions](#)
- [Regulatory and Safety Information](#)

# Safety Precautions

## Choosing a location

Do not install the machine in a location that is unstable or subject to excessive vibration.

Do not install the machine in locations that are very humid or dusty, in direct sunlight, outdoors, or close to a heating source.

To avoid the risk of fire or electric shocks, use the machine under the operating environment specified in the On-screen Manual.

Do not place the machine on a thick rug or carpet.

Do not place the machine with its back attached to the wall.

## Power supply

Ensure that the area around the power outlet is kept clear at all times so you can easily unplug the power cord if necessary.

Never remove the plug by pulling on the cord.

Pulling the cord may damage the power cord, leading to possible fire or electrical shock.

Do not use an extension lead/cord.

## Working around the machine

Never put your hands or fingers in the machine while it is printing.

When moving the machine, carry the machine at both ends. In case the machine weighs more than 14 kg, it is recommended to have two people lifting the machine. Accidental dropping of the machine causes injury. For the machine's weight, refer to the On-screen Manual.

Do not place any object on the machine. Especially do not place metal objects (paper clips, staples, etc.) or containers of flammable solvents (alcohol, thinners, etc.) on top of the machine.

Do not transport or use the machine on a slant, vertically or upside-down, as the ink may leak and damage the machine.

## Working around the machine (For the multifunction printer)

When loading a thick book on the Platen Glass, do not press hard on the Document Cover. The Platen Glass may break and cause injury.

## Print Heads/ink tanks and FINE Cartridges

Keep ink tanks out of the reach of children. In case ink\* is accidentally licked or swallowed, rinse out mouth or give one or two glasses of water to drink. If irritation or discomfort occurs, obtain medical advice immediately.

\* Clear Ink contains nitrate salts (For models containing Clear Ink).

In case ink gets in contact with eyes, rinse with water immediately. In case ink gets in contact with skin, wash with soap and water immediately. If irritation to eyes or skin persists, obtain medical advice immediately.

Never touch the electrical contacts on a Print Head or FINE Cartridges after printing.

The metal parts may be very hot and could cause burns.

Do not throw ink tanks and FINE Cartridges into fire.

Do not attempt to disassemble or modify the Print Head, ink tanks, and FINE Cartridges.

# Regulatory and Safety Information

## International ENERGY STAR® Program

As an ENERGY STAR Partner, Canon Inc. has determined that this product meets the ENERGY STAR guidelines for efficiency.



## About the disposal of the battery (For models containing lithium battery)

Dispose of used batteries according to the local regulations.

### Users in the U.S.A.

FCC Notice (U.S.A. Only)

For 120V, 60Hz model

Model Number: K10393/K10394/K10395/K10397 (Contains FCC ID: AZDK30356)

This device complies with Part 15 of the FCC Rules. Operation is subject to the following two conditions: (1) This device may not cause harmful interference, and (2) this device must accept any interference received, including interference that may cause undesired operation.

Note: This equipment has been tested and found to comply with the limits for a Class B digital device, pursuant to Part 15 of the FCC Rules. These limits are designed to provide reasonable protection against harmful interference in a residential installation. This equipment generates, uses and can radiate radio frequency energy and, if not installed and used in accordance with the instructions, may cause harmful interference to radio communications.

However, there is no guarantee that interference will not occur in a particular installation. If this equipment does cause harmful interference to radio or television reception, which can be determined by turning the equipment off and on, the user is encouraged to try to correct the interference by one or more of the following measures:

Reorient or relocate the receiving antenna.

Increase the separation between the equipment and receiver.

Connect the equipment into an outlet on a circuit different from that to which the receiver is connected.

Consult the dealer or an experienced radio/TV technician for help.

Use of a shielded cable is required to comply with Class B limits in Subpart B of Part 15 of the FCC Rules.

Do not make any changes or modifications to the equipment unless otherwise specified in the manual. If such changes or modifications should be made, you could be required to stop operation of the equipment.

FCC ID:AZDK30356

Changes or modifications not expressly approved by the party responsible for compliance could void the user's authority to operate equipment.

This transmitter must not be co-located or operating in conjunction with any other antenna or transmitter.

The equipment complies with FCC radiation exposure limits for uncontrolled equipment. This equipment should be installed and operated with minimum distance at least 20cm between the radiator and persons body (excluding extremities: hands, wrists, feet and ankles) and must not be colocated or operated with any other antenna or transmitter.

Canon U.S.A., Inc.  
One Canon Park  
Melville, New York 11747  
1-800-652-2666

## **Users in Canada**

This device complies with Industry Canada license-exempt RSS standard(s). Operation is subject to the following two conditions:

(1) this device may not cause interference, and (2) this device must accept any interference, including interference that may cause undesired operation of the device.

This equipment complies with IC radiation exposure limits set forth for an uncontrolled environment and meets RSS-102 of the IC radio frequency (RF) Exposure rules. This equipment should be installed and operated keeping the radiator at least 20cm or more away from person's body (excluding extremities: hands, wrists, feet and ankles).

## **Pour les usagers résidant au Canada**

Le présent appareil est conforme aux CNR d'Industrie Canada applicables aux appareils radio exempts de licence.

L'exploitation est autorisée aux deux conditions suivantes :

(1) l'appareil ne doit pas produire de brouillage, et (2) l'utilisateur de l'appareil doit accepter tout brouillage radioélectrique subi, même si le brouillage est susceptible d'en compromettre le fonctionnement.

Cet équipement est conforme aux limites d'exposition aux rayonnements énoncées pour un environnement non contrôlé et respecte les règles d'exposition aux fréquences radioélectriques (RF) CNR-102 de l'IC. Cet équipement doit être installé et utilisé en gardant une distance de 20 cm ou plus entre le dispositif rayonnant et le corps (à l'exception des extrémités : mains, poignets, pieds et chevilles).

## Users in Jordan

This printer contains WLAN Module approved by TRC/SS/2013/36

Name of WLAN Module : K30356

## European Union (and EEA) only.



This symbol indicates that this product is not to be disposed of with your household waste, according to the WEEE Directive (2002/96/EC) and your national law. This product should be handed over to a designated collection point, e.g., on an authorized one-for-one basis when you buy a new similar product or to an authorized collection site for recycling waste electrical and electronic equipment (EEE). Improper handling of this type of waste could have a possible negative impact on the environment and human health due to potentially hazardous substances that are generally associated with EEE. At the same time, your cooperation in the correct disposal of this product will contribute to the effective usage of natural resources. For more information about where you can drop off your waste equipment for recycling, please contact your local city office, waste authority, approved WEEE scheme or your household waste disposal service. For more information regarding return and recycling of WEEE products, please visit [www.canon-europe.com/environment](http://www.canon-europe.com/environment). (EEA: Norway, Iceland and Liechtenstein)

## India only.



This product is not to be disposed of with your household waste, according to the e-waste (Management and Handling) Rules, 2011.

This product should be handed over to a designated collection point, e.g., to an authorized collection site for recycling waste electrical and electronic equipment (EEE). Improper handling of this type of waste could have a possible negative impact on the environment and human health due to potentially hazardous substances that are generally associated with EEE. At the same time, your cooperation in the correct disposal of this product will contribute to the effective usage of natural resources. For more information regarding return and recycling of WEEE products, please visit <http://www.canon.co.in/environment/>.

Also, this product complies with the "India E-waste Rule 2011" and prohibits use of lead, mercury, hexavalent chromium, polybrominated biphenyls or polybrominated diphenyl ethers in concentrations exceeding 0.1 % by weight and 0.01 % by weight for Cadmium, except for the exemptions set in Schedule II of the Rule.

## Environmental Information

Reducing your environmental impact while saving money

Power Consumption and Activation Time

The amount of electricity a device consumes depends on the way the device is used. This product is designed and set in a way to allow you to reduce your electricity costs. After the last print it switches to Ready Mode. In this mode it can print again immediately if required. If the product is not used for a time, the device switches to its Power Save Mode. The devices consume less power (Watt) in these modes.

If you wish to set a longer Activation Time or would like to completely deactivate the Power Save Mode, please consider that this device may then only switch to a lower energy level after a longer period of time or not at all.

Canon does not recommend extending the Activation Times from the optimum ones set as default.

Energy Star®

The Energy Star® programme is a voluntary scheme to promote the development and purchase of energy efficient models, which help to minimise environmental impact.

Products which meet the stringent requirements of the Energy Star® programme for both environmental benefits and the amount of energy consumption will carry the Energy Star® logo accordingly.

Paper types

This product can be used to print on both recycled and virgin paper (certified to an environmental stewardship scheme), which complies with EN12281 or a similar quality standard. In addition it can support printing on media down to a weight of 64g/m<sup>2</sup>, lighter paper means less resources used and a lower environmental footprint for your printing needs.

CE

# Main Components and Basic Operations

- Main Components
- About the Power Supply of the Machine
- Using the Operation Panel

# Main Components

- Front View
- Rear View
- Inside View
- Operation Panel



## Front View

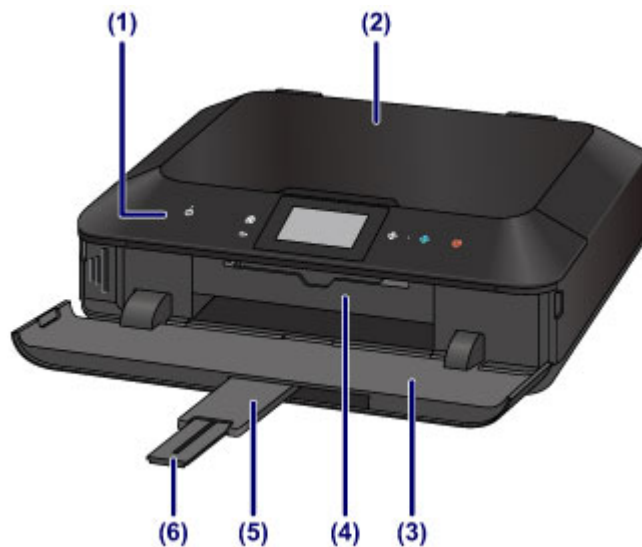

### **(1) operation panel**

Use to change the settings of the machine or to operate it. Also, lift and open it to replace an ink tank, to check the ink lamp, or to remove jammed paper inside the machine.

➔ [Operation Panel](#)

### **(2) document cover**

Open to load an original on the platen glass.

### **(3) paper output tray**

Opens automatically when printing or copying starts and printed paper is ejected. Also, you need to open it to insert a memory card.

### **(4) inner cover**

Open by pulling it out to attach the disc tray. Use only when printing onto a printable disc. Keep closed for normal operation.

### **(5) output tray extension**

Opens automatically when you open the paper output tray, and supports ejected paper.

### **(6) paper output support**

Extend to support ejected paper.



### **(7) cassette (upper)**

Load 4" x 6" (10 x 15 cm) or 5" x 7" (13 x 18 cm) size photo paper into the cassette, and insert it into the machine. Two or more papers of the same size and media type can be loaded at the same time, which are fed automatically one sheet at a time.

#### ➔ [Loading Small Size Paper](#)

The disc tray can be stored in the back of the cassette (upper).

#### ➔ [How to Detach / Attach the Disc Tray](#)

### **(8) cassette (lower)**

Load A4, B5, A5, or Letter-sized plain paper or photo paper and envelopes into the cassette, and insert it into the machine. Two or more papers of the same size and media type can be loaded at the same time, which are fed automatically one sheet at a time.

#### ➔ [Loading Large Size Paper](#)

#### ➔ [Loading Envelopes](#)

### **(9) platen glass**

Load an original to copy or scan.

## Rear View

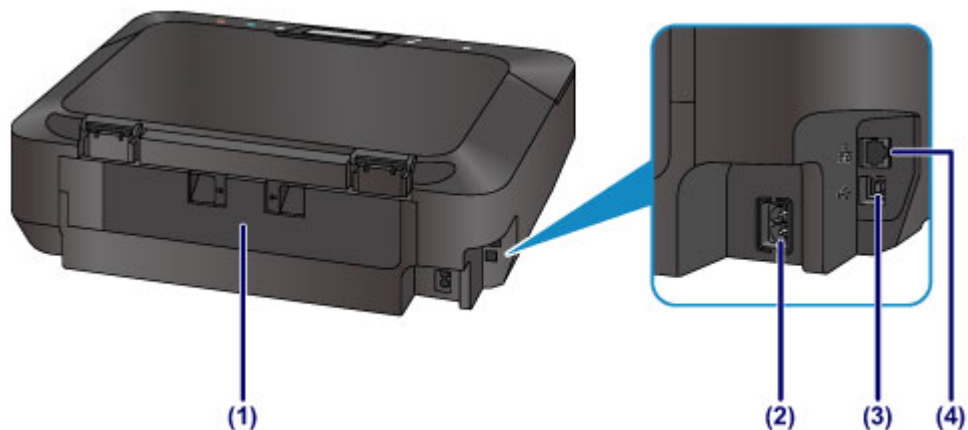

### (1) rear cover

Detach to remove jammed paper.

### (2) power cord connector

Plug in the supplied power cord.

### (3) USB port

Plug in the USB cable to connect the machine with a computer.

### (4) wired LAN connector

Plug in the LAN cable to connect the machine to a LAN.

### ►► Important

- Do not touch the metal casing.
- Do not plug in or unplug the USB cable or LAN cable while the machine is printing or scanning originals with the computer.

## Inside View

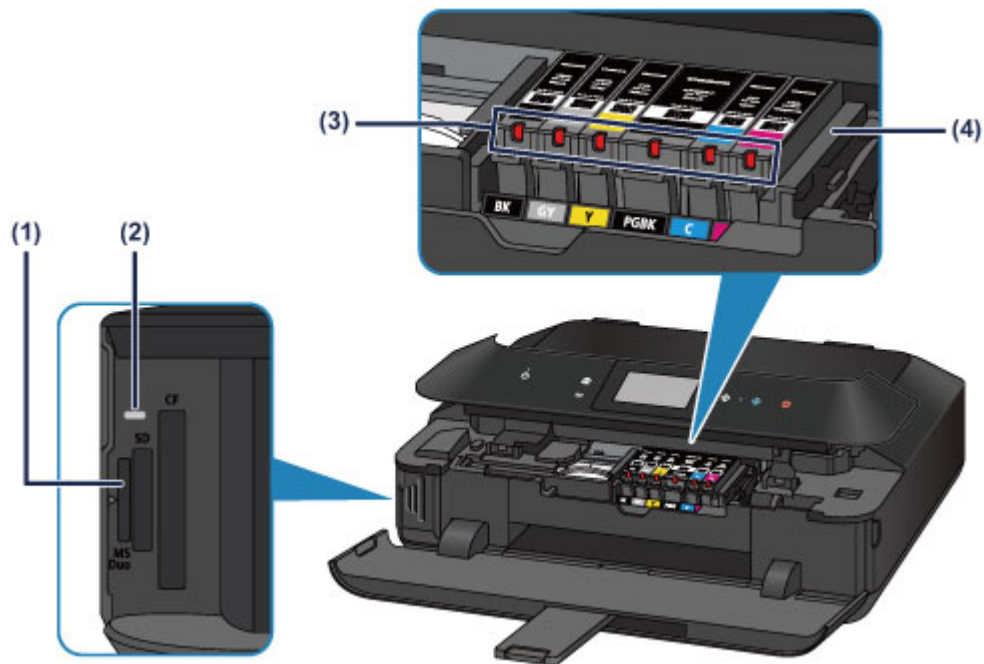

### (1) card slot

Insert a memory card.

➔ [Before Inserting the Memory Card](#)

### (2) Access lamp

Lights or flashes to indicate the memory card status.

➔ [Inserting Card](#)

### (3) ink lamps

Lights or flashes red to indicate the ink tank status.

➔ [Checking the Ink Status with the Ink Lamps](#)

### (4) print head holder

The print head is pre-installed.

### ➤➤➤ Note

- For details on replacing an ink tank, see [Replacing an Ink Tank](#).

# Operation Panel

\* All buttons and lamps on the operation panel are shown lit in the illustration below for explanatory purposes.

Only available buttons will be lit.

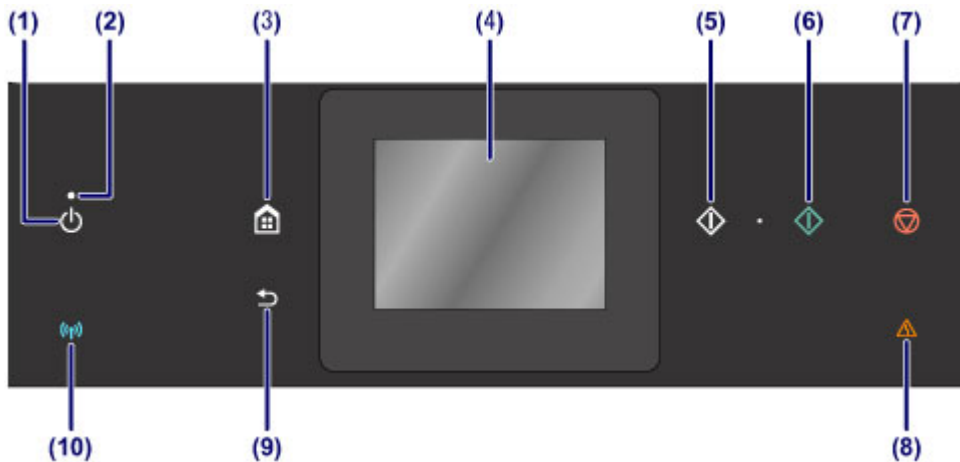

## (1) ON button

Turns the power on or off. Before turning on the power, make sure that the document cover is closed.

➔ [Turning the Machine On and Off](#)

## (2) POWER lamp

Lights white after flashing when the power is turned on.

## (3) HOME button

Used to display the HOME screen.

➔ [Using the Operation Panel](#)

## (4) touch screen

Displays messages, menu items, and the operational status. Directly touch the screen lightly with your finger tip to select a menu item or displayed button. You can also preview photos on a memory card before printing.

➔ [Basic Operation of the touch screen](#)

## (5) Black button

Starts black & white copying, scanning, etc.

## (6) Color button

Starts color printing, copying, scanning, etc.

## (7) Stop button

Cancels operation when print, copy, or scan job is in progress.

## (8) Alarm lamp

Lights or flashes orange when an error occurs, such as paper-out or ink-out.

## (9) Back button

Returns the screen to the previous screen.

## (10) Wi-Fi lamp

Lights or flashes blue to indicate the wireless LAN status.

Lights:

**Wireless LAN active** is selected.

Flashes:

Printing or scanning over wireless LAN. Also flashes while configuring the wireless LAN connection.

### »» Note

- When buttons on the operation panel are touched, the machine generates keypad or alarm sounds as necessary. The sound volume can be adjusted in **Volume control** of **Device user settings**.

➔ [Device user settings](#)

## About the Power Supply of the Machine

- Confirming that the Power Is On
- Turning the Machine On and Off
- Notice for the Power Plug/Power Cord
- Notice for Unplugging the Power Cord

## Confirming that the Power Is On

The **POWER** lamp is lit white when the machine is turned on.

Even if the buttons on the operation panel and the touch screen display are off, if the **POWER** lamp is lit, the machine is on.

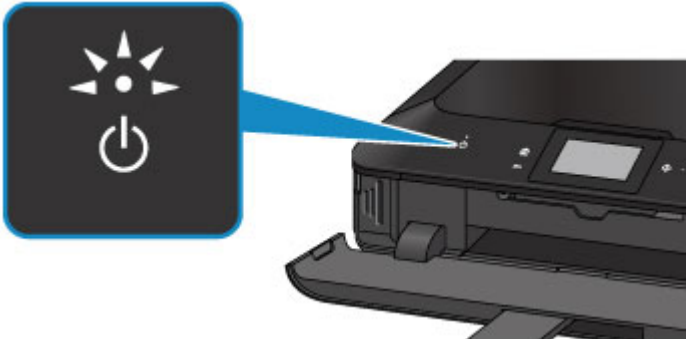

### »» Note

- It may take a while for the machine to start printing immediately after you turn on the machine.
- The buttons on the operation panel and the touch screen display will turn off if the machine is not operated for about 5 minutes. To restore the display, touch the touch screen. The touch screen display will be restored, and the available buttons also displayed. The print operation from a computer can also restore the display.



# Turning the Machine On and Off

## Turning on the machine

1. Touch the **ON** button to turn on the machine.

The **POWER** lamp flashes and then remains lit white.

➔ [Confirming that the Power Is On](#)

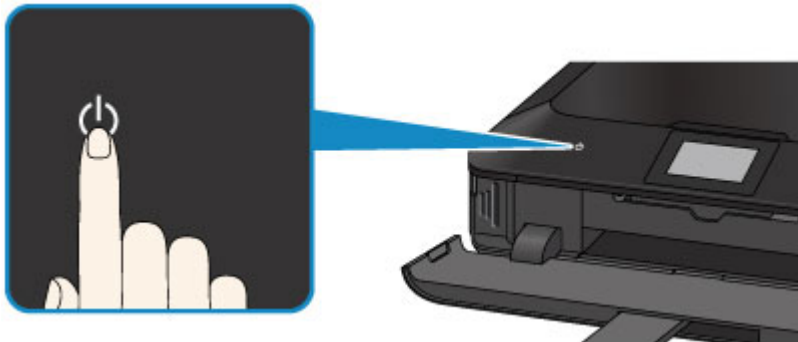

### ➤➤ Note

- It may take a while for the machine to start printing immediately after you turn on the machine.
- If the **Alarm** lamp lights up or flashes orange and an error message is displayed on the touch screen, see [A Message Is Displayed](#).

#### **Auto power on feature**

- You can set the machine to automatically turn on when a print or scan operation is performed from a computer connected by USB cable or network. This feature is set to off by default.

From the machine

➔ [About ECO settings](#)

From the computer

➔ [Managing the Machine Power](#)

## Turning off the machine

1. Touch the **ON** button to turn off the machine.

When the **POWER** lamp stops flashing, the machine is turned off.

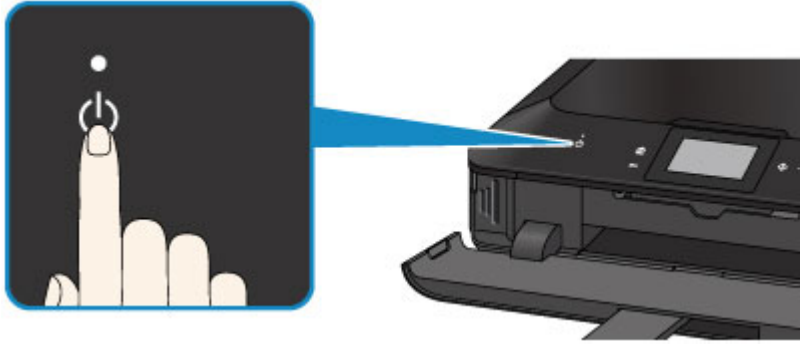

### ►► Important

- When you unplug the power cord after turning off the machine, be sure to confirm that the **POWER** lamp is off.

➔ [Notice for Unplugging the Power Cord](#)

### ►► Note

#### Auto power off feature

- You can set the machine to automatically turn off when no operations are performed or no print jobs are sent to the machine for a certain interval. This is the default setting.

From the machine

➔ [About ECO settings](#)

From the computer

➔ [Managing the Machine Power](#)

## Notice for the Power Plug/Power Cord

Unplug the power cord once a month to confirm that the power plug/power cord does not have anything unusual described below.

- The power plug/power cord is hot.
- The power plug/power cord is rusty.
- The power plug/power cord is bent.
- The power plug/power cord is worn.
- The power plug/power cord is split.

### **Caution**

- If you find anything unusual with the power plug/power cord described above, unplug the power cord and call for service. Using the machine with one of the unusual conditions above may cause a fire or an electric shock.

➔ [Notice for Unplugging the Power Cord](#)

## Notice for Unplugging the Power Cord

To unplug the power cord, follow the procedure below.

### ►► Important

- When you unplug the power cord, touch the **ON** button, then confirm that the **POWER** lamp is off. Unplugging the power cord while the **POWER** lamp is lit or flashing may cause drying or clogging of the print head and print quality may be reduced.

1. Touch the **ON** button to turn the machine off.

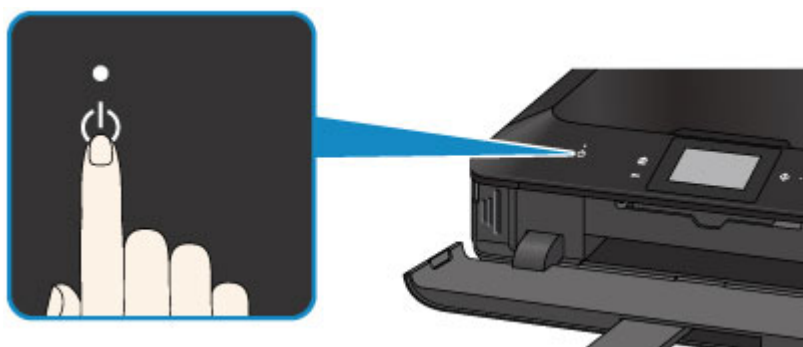

2. Confirm that the **POWER** lamp is off.

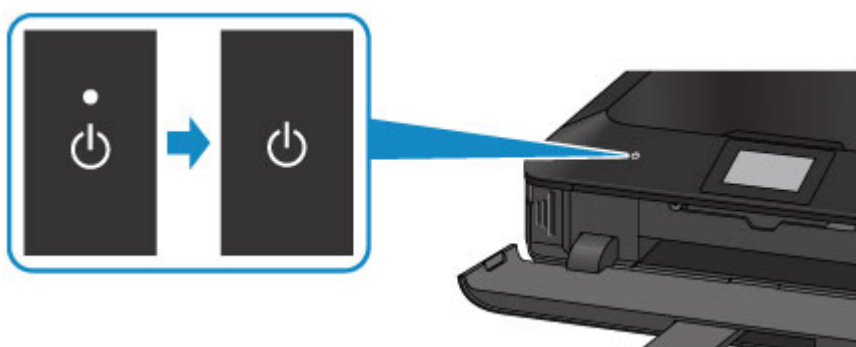

3. Unplug the power cord.

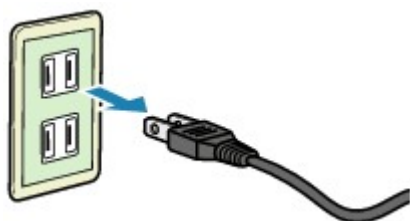

The specification of the power cord differs depending on the country or region of use.

# Using the Operation Panel

The operation panel lets you print photos on a memory card, make copies, and scan without using the computer.

The operation panel consists of the touch screen **(A)** and buttons **(B)** that light up.

The HOME screen on the touch screen lets you access the machine's various functions.

The HOME screen comprises three separate screens. To perform copying, photo printing, or scanning, switch to their respective screens.

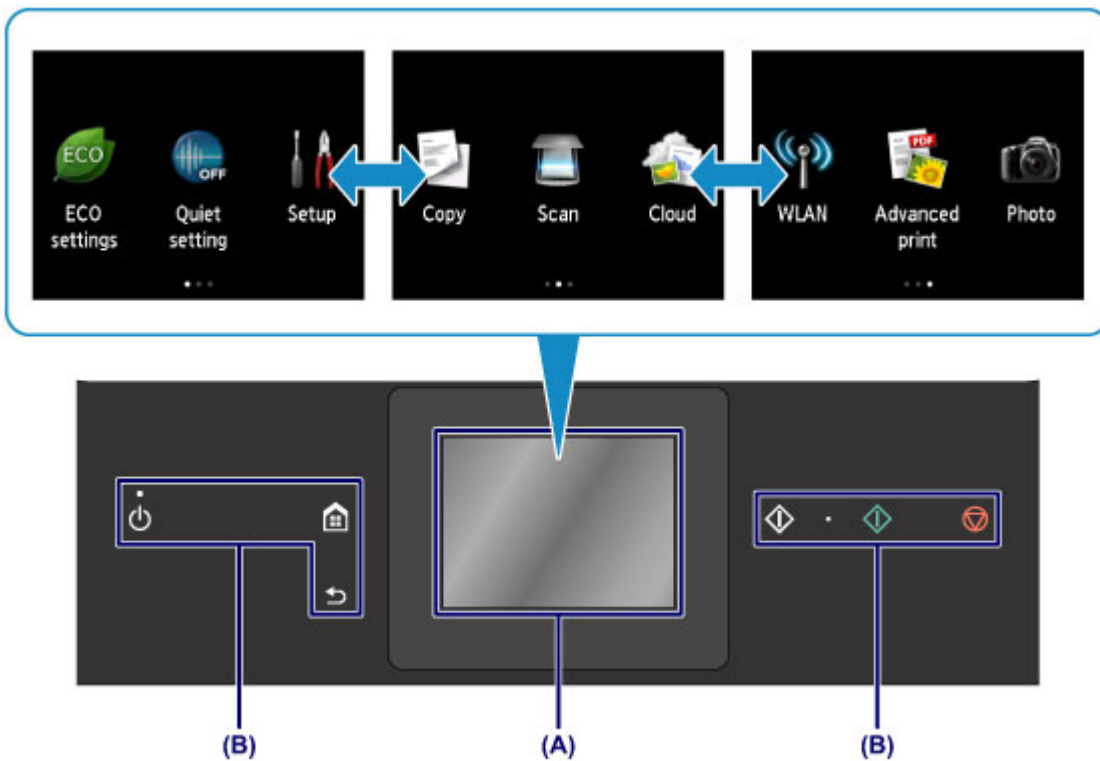

**(A)** touch screen

Lightly touch a menu, button, or icon on the screen with your finger tip.

➔ [Basic Operation of the touch screen](#)

**(B)** Buttons on the operation panel

Which buttons **(B)** are lit on the operation panel depend on the screen being displayed. To aid operation, only buttons available for the current screen light up.

To select a button, touch it lightly with your finger tip.

## ➔➔➔ Important

### Notes on using the operation panel

- Do not place any object (especially metallic objects or objects containing moisture) on the operation panel. Doing so may cause the machine to malfunction.
- Precious metals, such as in rings and bracelets, may cause malfunction of the machine. When using the operation panel, keep such metals at least 0.8 inches (2 cm) away from the operation panel.

## Basic Operation of the touch screen

Touch the touch screen lightly with your finger tip or move your finger to access various functions or settings.

### »» Important

- When operating the touch screen, make sure to avoid the followings, which may cause the machine to malfunction or damage the machine.
  - Strongly pressing the touch screen.
  - Pressing the touch screen with other than your finger (especially with sharpened tips, such as on ballpoint pens, pencils, or nails).
  - Touching the touch screen with wet or dirty hands.
  - Placing any objects on the touch screen.

### Tap

Touch lightly with your finger tip and immediately release.

Use to select an item or photo on the screen.



### Touch

Touch lightly with your finger tip.

To move forward (or go back) menus or photos continuously, keep touching the forward (or back) mark.

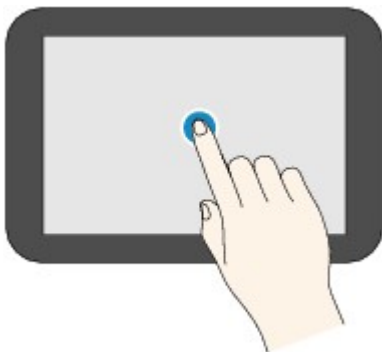

### Flick

Flick your finger on the screen up, down, left, or right.

Use to switch menus or move forward or backward through photos.

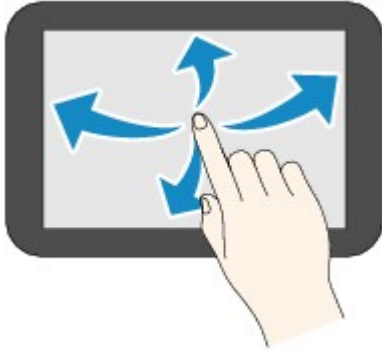

## Drag

While lightly touching the screen, move your finger up, down, left, or right.  
Use to view lists of items or move sliders.

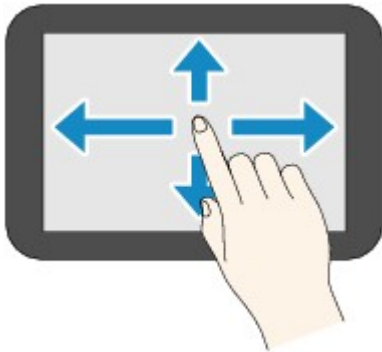

## An Operation Example of the touch screen

Example: Operating the touch screen in the photo selection screen

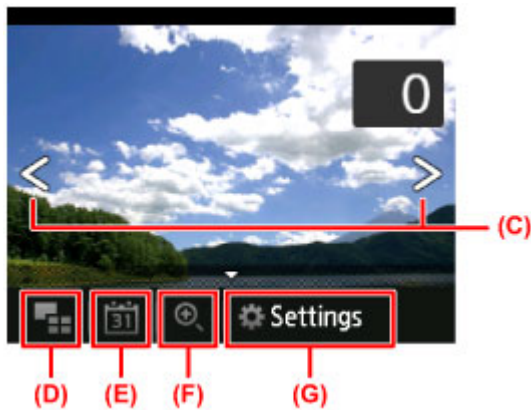

Flick your finger left or right on a photo to display the next or previous photo.  
You can also tap the marks **(C)** to do the same. To move continuously forwards or backwards through photos, hold your touch on either of the marks **(C)**.

Tap **(D)** to switch to a screen that displays multiple photos.

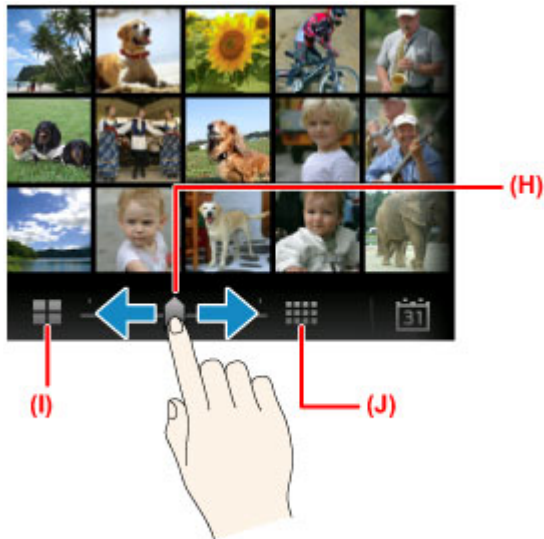

Drag the slide bar **(H)** left or right to change the number of photos displayed on the screen. Tapping **(I)** or **(J)** also changes it.

Tap **(E)** to display the **To most recent date** screen.



Flick left or right and tap the date of photos to display.

Tap **(F)** to enlarge/reduce the photo.

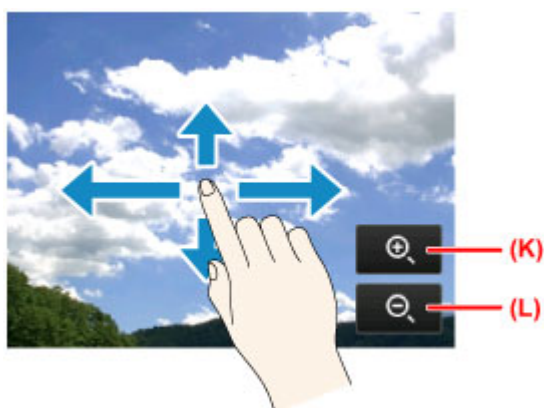

Tap **(K)** to enlarge the photo and **(L)** to reduce it.

Drag your finger on the photo to display the part you want to see.

Tap **(G)** to display the **Settings** screen.



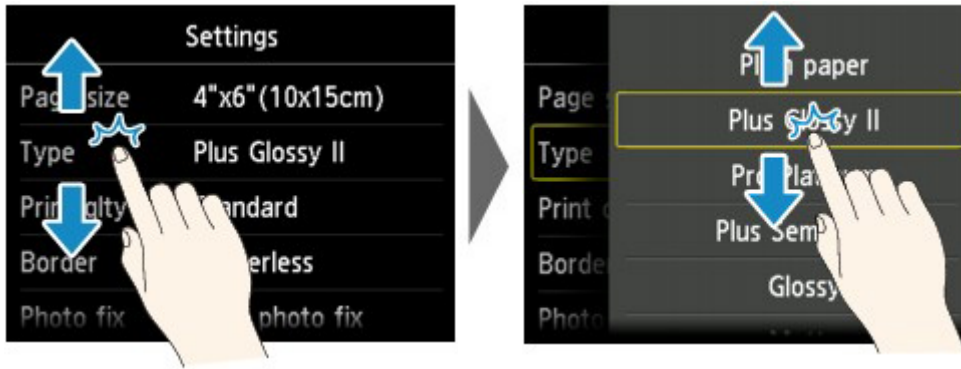

Drag the screen up or down and tap an item to select.

This opens another list of items. Drag it in the same manner and tap a setting.

## Loading Paper / Originals

- Loading Paper
- Placing a Printable Disc
- Loading Originals
- Inserting the Memory Card

# Loading Paper

- Paper Sources to Load Paper
- Loading Small Size Paper
- Loading Large Size Paper
- Loading Envelopes
- Media Types You Can Use
- Media Types You Cannot Use
- Before Printing on Art Paper
- Printing Area

## Paper Sources to Load Paper

The machine has two paper sources for feeding paper, the cassette (upper) and cassette (lower).

The paper source used depends on the page size and media type.

➔ [Media Types You Can Use](#)

### ▶▶▶ Note

- When printing, select the correct page size and media type. If you select the wrong page size or media type, the machine may feed paper from the wrong paper source or may not print with the proper print quality.

For details on how to load paper in each paper source, see below.

➔ [Loading Small Size Paper](#)

➔ [Loading Large Size Paper](#)

➔ [Loading Envelopes](#)

### Loading Small Size Photo Paper in the cassette (upper)

When using small size photo paper, such as 4" x 6" (10 x 15 cm) or 5" x 7" (13 x 18 cm), load it in the cassette (upper).

The machine feeds photo paper from the cassette (upper) automatically if you select a page size such as 4" x 6" (10 x 15 cm) or 5" x 7" (13 x 18 cm) in the print settings at the operation panel or the printer driver.

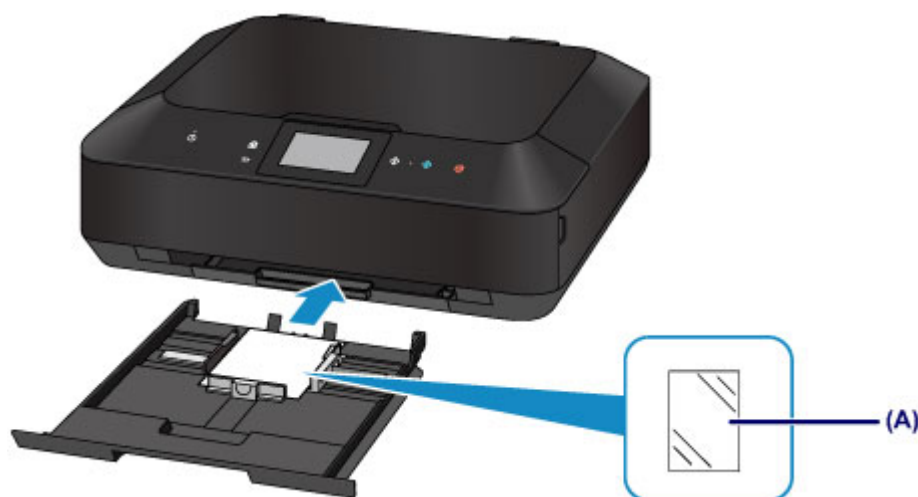

(A) Photo paper (4" x 6" (10 x 15 cm) or 5" x 7" (13 x 18 cm) size)

### Loading Large Size Photo Paper / Plain Paper or Envelopes in the cassette (lower)

When using large size photo paper or plain paper, such as A4, B5, A5, or Letter, load it in the cassette (lower). You can also load envelopes in the cassette (lower).

The machine feeds paper from the cassette (lower) automatically if you select a page size such as A4, B5, A5, or Letter in the print settings at the operation panel or the printer driver.

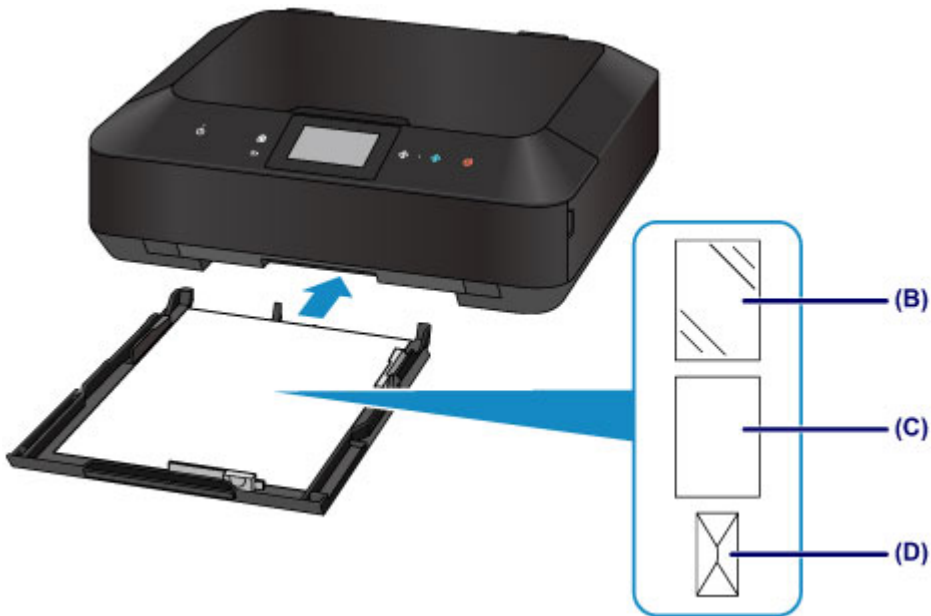

**(B)** Photo paper (A4, 8" x 10" (20 x 25 cm), or Letter size)

**(C)** Plain paper (A4, B5, A5, Letter, or Legal size)

**(D)** Envelopes

### Loading Paper with the Print Side Facing Down

If paper has print side (front or back), such as photo paper, load it with the whiter side (or glossy side) facing down.

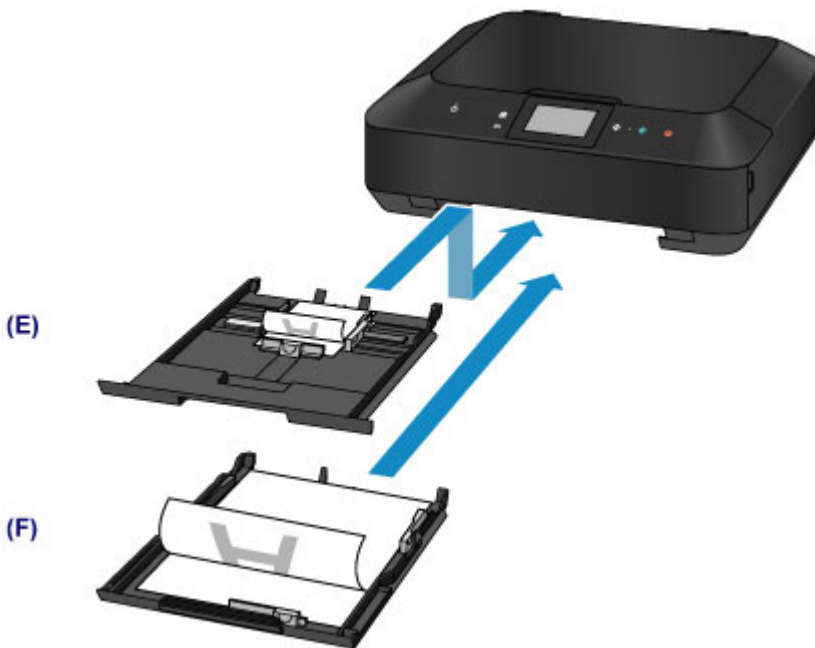

**(E)** cassette (upper)

**(F)** cassette (lower)

## Loading Small Size Paper

You can load 4" x 6" (10 x 15 cm) or 5" x 7" (13 x 18 cm) size photo paper in the cassette (upper).

Load large sizes of paper in the cassette (lower).

➔ [Loading Large Size Paper](#)

### ▶▶▶ Important

- If you cut plain paper into small size such as 4" x 6" (10 x 15 cm) or 5" x 7" (13 x 18 cm) to perform trial print, it can cause paper jams.

### ▶▶▶ Note

- We recommend Canon genuine photo paper for printing photos.  
For details on the Canon genuine paper, see [Media Types You Can Use](#).

## 1. Prepare paper.

Align the edges of paper. If paper is curled, flatten it.

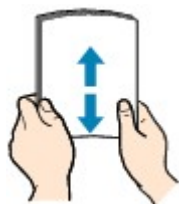

### ▶▶▶ Note

- Align the edges of paper neatly before loading. Loading paper without aligning the edges may cause paper jams.
- If paper is curled, hold the curled corners and gently bend them in the opposite direction until the paper becomes completely flat.  
For details on how to flatten curled paper, see "Load the paper after correcting its curl." in Paper Is Smudged/Printed Surface Is Scratched.
- When using Photo Paper Plus Semi-gloss SG-201, even if the sheet is curled, load one sheet at a time as it is. If you roll up this paper to flatten, this may cause cracks on the surface of the paper and reduce the print quality.

## 2. Load paper.

(1) Pull out the cassette (upper) from the machine.



(2) Slide the paper guide **(A)** in front and **(B)** on the right to open the guides.

(3) Load the paper stack WITH THE PRINT SIDE FACING DOWN, and place it in the center of the cassette (upper).

### »» Important

- Always load paper in the portrait orientation **(C)**. Loading paper in the landscape orientation **(D)** can cause paper jams.

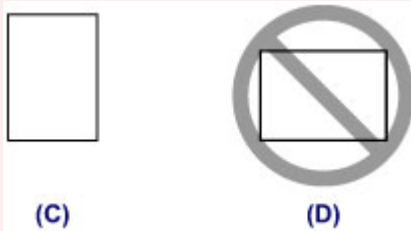

### »» Note

- Align the paper stack with the edge of the cassette (upper) as shown in the figure below.  
If the paper stack is in contact with the protrusions **(E)**, the paper may not be fed properly.
- If paper has print side (front or back), such as photo paper, load it with the whiter side (or glossy side) facing down.

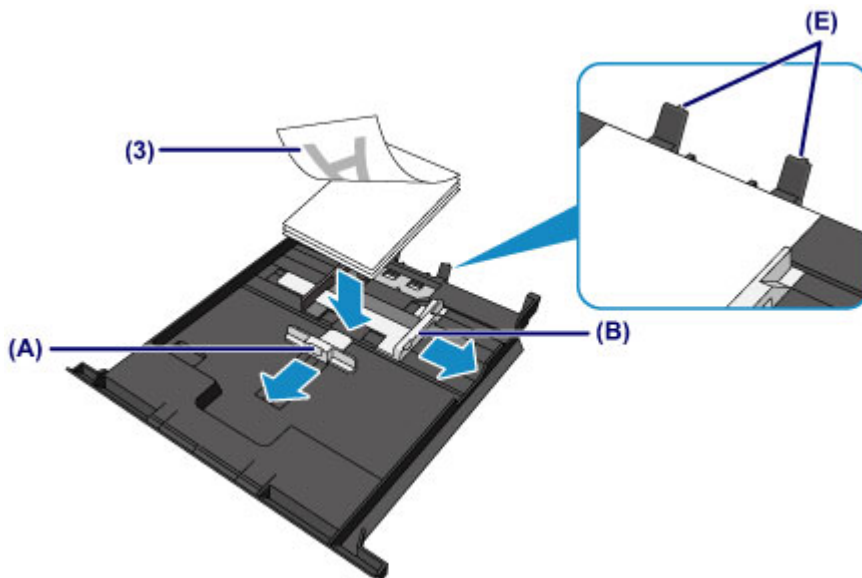

**(4)** Align the paper guide **(A)** in front with the paper stack.

For standard sizes, align the paper guide **(A)** with where it clicks into place.

**(5)** Slide the paper guide **(B)** on the right to align the right and left guides with both sides of the paper stack.

Do not slide the paper guides too hard against the paper. The paper may not be fed properly.

### ►►► Note

- Do not load sheets of paper higher than the load limit mark **(F)**.
- Keep the paper stack height below the tabs **(G)** of the paper guides.

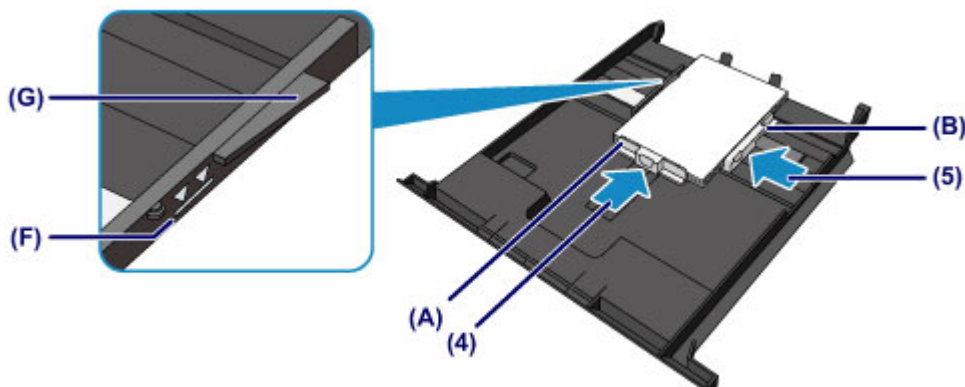

**(6)** Insert the cassette (upper) into the machine.

Push the cassette (upper) all the way into the machine.





### 3. Open the paper output tray.

#### (1) Holding both sides of the paper output tray, gently open it.

The output tray extension opens automatically when the paper output tray is opened.



#### »» Note

##### After loading paper

- Select the size and type of the loaded paper on the print settings screen of the operation panel or printer driver.

## Loading Large Size Paper

You can load A4, B5, A5, 8" x 10" (20 x 25 cm), Letter, or Legal-sized photo paper or plain paper in the cassette (lower).

You can also load envelopes in the cassette (lower).

### ➔ Loading Envelopes

Load small sizes of paper in the cassette (upper).

### ➔ Loading Small Size Paper

#### »» Note

- We recommend Canon genuine photo paper for printing photos.  
For details on the Canon genuine paper, see [Media Types You Can Use](#).
- You can use general copy paper.  
For the page size and paper weight you can use for this machine, see [Media Types You Can Use](#).

### 1. Prepare paper.

Align the edges of paper. If paper is curled, flatten it.

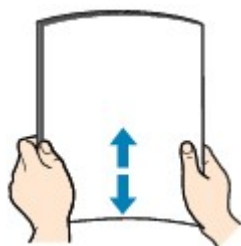

#### »» Note

- Align the edges of paper neatly before loading. Loading paper without aligning the edges may cause paper jams.
- If paper is curled, hold the curled corners and gently bend them in the opposite direction until the paper becomes completely flat.  
For details on how to flatten curled paper, see "Load the paper after correcting its curl." in Paper Is Smudged/Printed Surface Is Scratched.
- When using Photo Paper Plus Semi-gloss SG-201, even if the sheet is curled, load one sheet at a time as it is. If you roll up this paper to flatten, this may cause cracks on the surface of the paper and reduce the print quality.

### 2. Load paper.

(1) Pull out the cassette (lower) from the machine.



(2) Slide the paper guide **(A)** in front and **(B)** on the right to open the guides.

(3) Load the paper stack WITH THE PRINT SIDE FACING DOWN, and place it in the center of the cassette (lower).

»» **Important**

- Always load paper in the portrait orientation **(C)**. Loading paper in the landscape orientation **(D)** can cause paper jams.

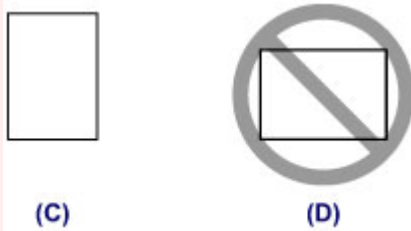

»» **Note**

- Align the paper stack with the edge of the cassette (lower) as shown in the figure below.  
If the paper stack is in contact with the protrusion **(E)**, the paper may not be fed properly.
- If paper has print side (front or back), such as photo paper, load it with the whiter side (or glossy side) facing down.

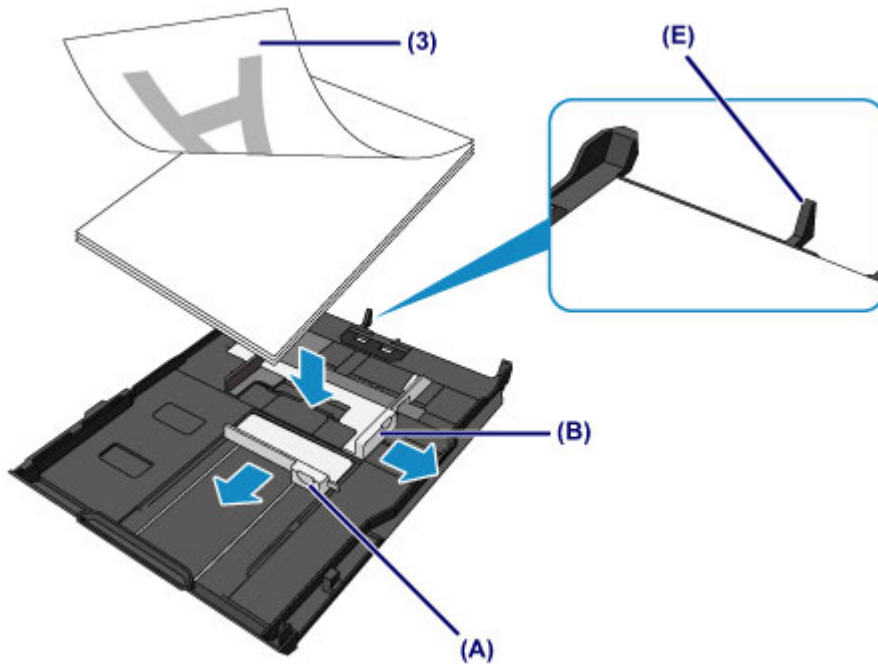

**(4)** Align the paper guide **(A)** in front with the paper stack.

For standard sizes, align the paper guide **(A)** with where it clicks into place.

**(5)** Slide the paper guide **(B)** on the right to align the right and left guides with both sides of the paper stack.

Do not slide the paper guides too hard against the paper. The paper may not be fed properly.

### ►► Note

- Do not load sheets of paper higher than the load limit mark **(F)**.
- Keep the paper stack height below the tabs **(G)** of the paper guides.

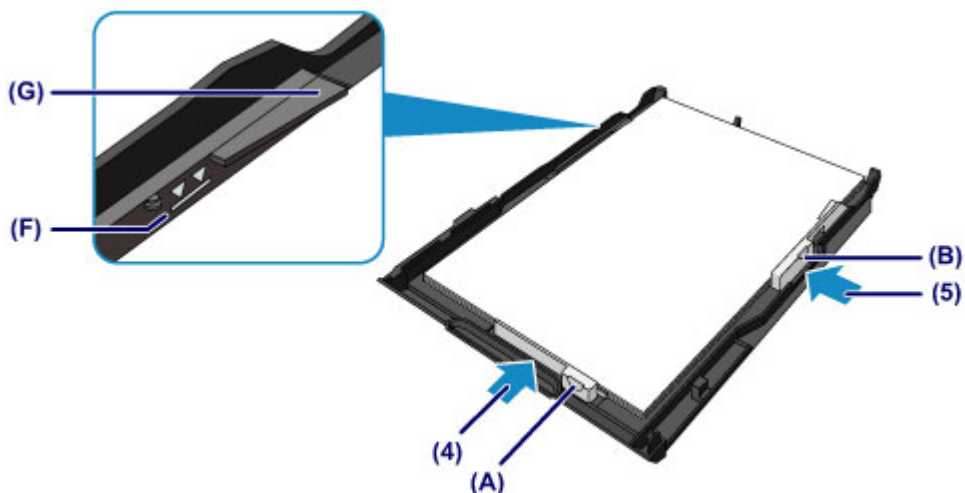

### ►► Note

#### Loading paper larger than A4 size

- To load paper larger than A4 size in the cassette (lower), press down the lock **(H)** on the cassette (lower), then extend the cassette (lower).

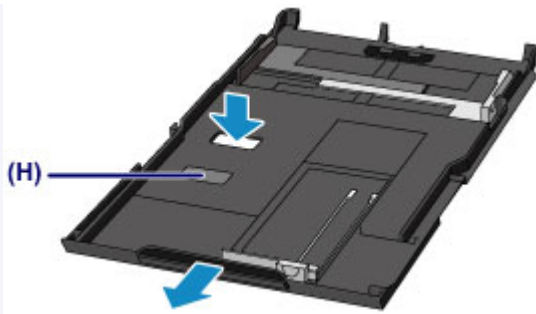

The cassette (lower) sticks out of the machine when correctly set. Do not force the cassette (lower) into the machine any further. This can damage the machine or cassette (lower).



**(6) Insert the cassette (lower) into the machine.**

Push the cassette (lower) into the machine until it stops.



**3. Open the paper output tray.**

**(1) Holding both sides of the paper output tray, gently open it.**

The output tray extension opens automatically when the paper output tray is opened.

**(2) Extend the paper output support.**

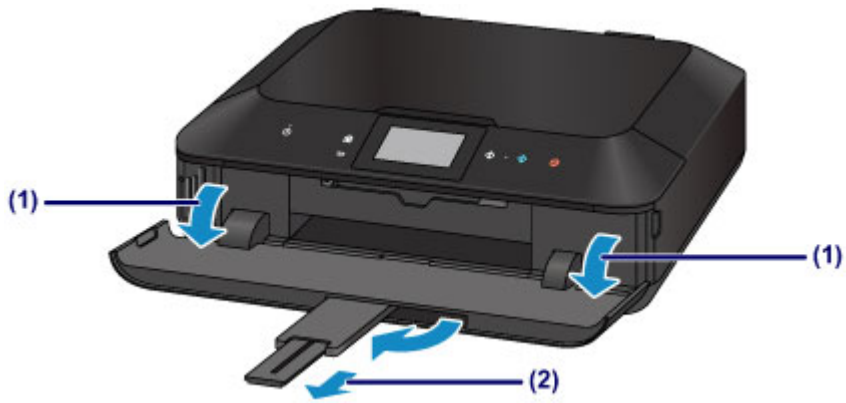

## ►► Note

### After loading paper

- Select the size and type of the loaded paper on the print settings screen of the operation panel or printer driver.

# Loading Envelopes

You can load Envelope DL and Envelope Com 10.

The address is automatically rotated and printed according to the envelope's direction by specifying with the printer driver properly.

## »» Important

- Printing of envelopes from the operation panel or from a digital camera is not supported.
- Do not use the following envelopes. They could jam in the machine or cause the machine to malfunction.
  - Envelopes with an embossed or treated surface
  - Envelopes with a double flap
  - Envelopes whose gummed flaps are already moistened and adhesive

## 1. Prepare envelopes.

- Press down on all four corners and edges of the envelopes to flatten them.

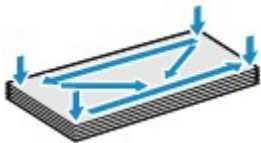

- If the envelopes are curled, hold the opposite corners and gently twist them in the opposite direction.



- If the corner of the envelope flap is folded, flatten it.

## »» Important

- The envelopes may jam in the machine if they are not flat or the edges are not aligned. Make sure that no curl or puff exceeds 0.1 inches (3 mm).
- Do not flatten the leading edge of envelopes. Otherwise, the printing position may shift out of place.

## 2. Load envelopes.

- (1) Pull out the cassette (lower) from the machine.



(2) Slide the paper guide **(A)** in front and **(B)** on the right to open the guides.

(3) Load the envelopes WITH THE PRINT SIDE FACING DOWN, and place them in the center of the cassette (lower).

The folded flap of the envelope will be faced up on the left side.

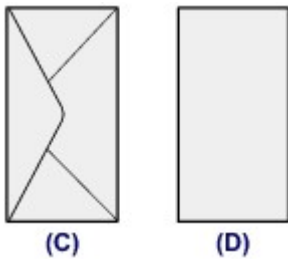

(C) Rear side

(D) Address side

Up to 10 envelopes can be loaded at once.

### ►► Note

- Align the envelope stack with the edge of the cassette (lower) as shown in the figure below.  
If the envelopes are in contact with the protrusion **(E)**, the envelopes may not be fed properly.



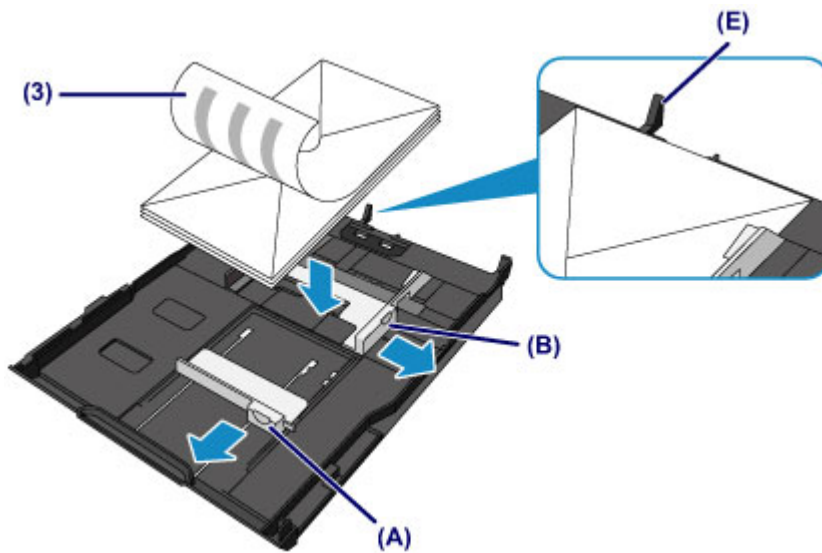

**(4)** Align the paper guide **(A)** in front with the envelopes.

**(5)** Slide the paper guide **(B)** on the right to align the right and left guides with both sides of the envelopes.

Do not slide the paper guides too hard against the envelopes. The envelopes may not be fed properly.

### ►► Note

- Do not load envelopes higher than the load limit mark **(F)**.
- Keep the envelope stack height below tabs **(G)** of the paper guides.

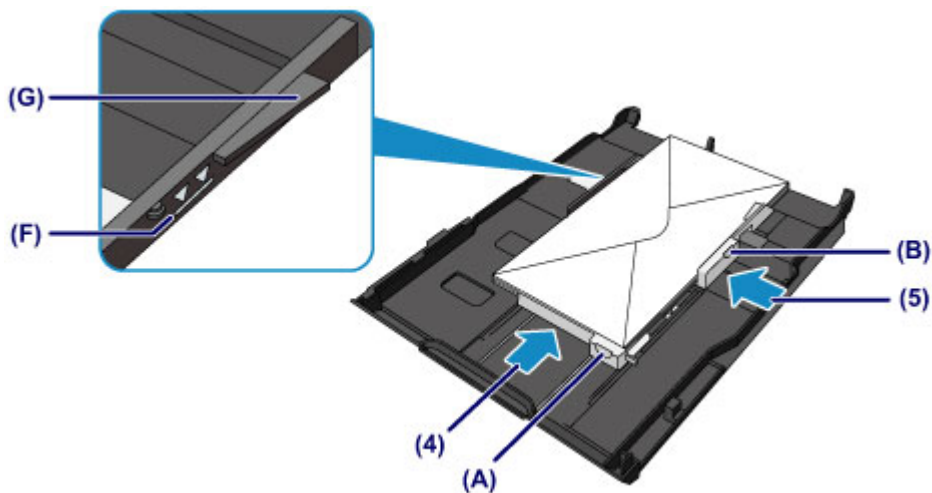

**(6)** Insert the cassette (lower) into the machine.

Push the cassette (lower) into the machine until it stops.



### 3. Open the paper output tray.

**(1)** Holding both sides of the paper output tray, gently open it.

The output tray extension opens automatically when the paper output tray is opened.

**(2)** Extend the paper output support.

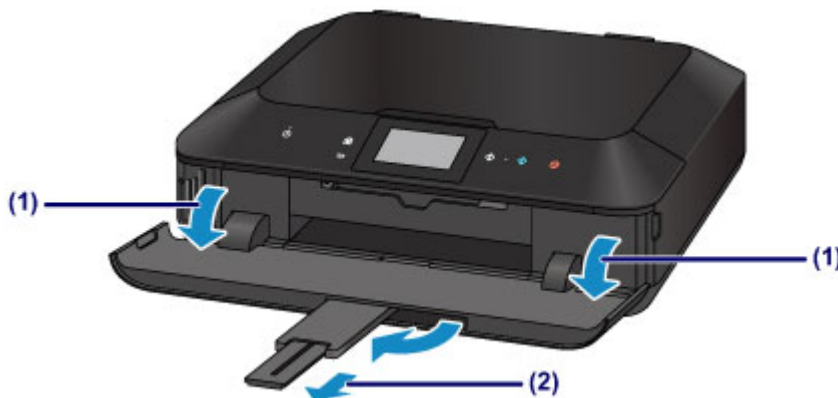

#### »» Note

##### After loading envelopes

- Select the size and type of the loaded envelopes on the print settings screen of the printer driver.

# Media Types You Can Use

Choose paper suitable for printing, for the best print results. Canon provides you various types of paper to enhance the fun of printing, such as stickers as well as papers for photo or document. We recommend the use of Canon genuine paper for printing your important photos.

## Media Types

### Commercially available papers

- Plain Paper (including recycled paper)<sup>\*1</sup>
- Envelopes<sup>\*2</sup>

### Canon genuine papers

The Model Number of Canon genuine paper is shown in brackets. Refer to the instruction manual supplied with the paper for detailed information on the printable side and notes on handling paper. For information on the page sizes available for each Canon genuine paper, access our website.

#### ►► Note

- You may not be able to purchase some Canon genuine papers depending on the country or region of purchase. Paper is not sold in the US by Model Number. Purchase paper by name.

### Paper for printing photos:

- Photo Paper Pro Platinum <PT-101>
- Glossy Photo Paper "Everyday Use" <GP-501/GP-601>
- Photo Paper Glossy <GP-601>
- Photo Paper Plus Glossy II <PP-201>
- Photo Paper Pro Luster <LU-101>
- Photo Paper Plus Semi-gloss <SG-201>
- Matte Photo Paper <MP-101>

### Paper for printing business documents:

- High Resolution Paper <HR-101N><sup>\*2</sup>

### Paper for creating your own prints:

- T-Shirt Transfers <TR-301><sup>\*2</sup>

## ● Photo Stickers <PS-101>

\*1 100% recycled paper can be used.

\*2 Printing to this paper from the operation panel or from a digital camera is not supported.

➔ [Paper Load Limit](#)

➔ [Media Type Settings on the Operation Panel](#)

➔ [Setting the Media Type with the Printer Driver](#)

### ▶▶▶ Note

- You can print onto a printable disc using the disc tray supplied with the machine.
  - ➔ [Placing a Printable Disc](#)
- When printing photos saved on a PictBridge compliant device, you must specify the page size and media type.
  - ➔ [Printing from a Digital Camera](#)
- You can use non-Canon genuine art paper. For details, access our website.  
You cannot print in the top and bottom 1.38 inch (35 mm) margins of the paper (in the printing direction).
  - ➔ [Sizes for Art Paper](#)
  - ➔ [Before Printing on Art Paper](#)

## Page Sizes

You can use the following page sizes.

### ▶▶▶ Note

- You can load the page sizes as follows.
  - cassette (upper): 4" x 6" (10 x 15 cm) and 5" x 7" (13 x 18 cm)
  - cassette (lower): A4, B5, A5, Letter, Legal, 8" x 10" (20 x 25 cm), Envelope DL, and Envelope Com 10
- Printing on the following paper sizes from the operation panel or from a digital camera is not supported.
  - Legal and Envelopes

### Standard sizes:

- |                        |                         |
|------------------------|-------------------------|
| ● Letter               | ● Legal                 |
| ● A5                   | ● A4                    |
| ● B5                   | ● 4" x 6" (10 x 15 cm)  |
| ● 5" x 7" (13 x 18 cm) | ● 8" x 10" (20 x 25 cm) |
| ● Envelope DL          | ● Envelope Com 10       |

### Non-standard sizes:

You can print on non-standard size paper within the following ranges.

- cassette (upper)
  - Minimum size: 3.50 x 5.00 inches (89.0 x 127.0 mm)
  - Maximum size: 7.87 x 7.28 inches\* (200.0 x 184.9 mm\*)
- cassette (lower)
  - Minimum size: 3.54 x 7.29 inches\* (90.0 x 185.0 mm\*)
  - Maximum size: 8.50 x 14.00 inches (215.9 x 355.6 mm)

\* Paper may be fed from a different paper source depending on the operating system of your computer.

## Paper Weight

You can use paper in the following weight range.

- 17 to 28 lb (64 to 105 g /m<sup>2</sup>) (except for Canon genuine paper)

Do not use heavier or lighter paper (except for Canon genuine paper), as it could jam in the machine.

## Notes on Storing Paper

- Take out only the necessary number of paper from the package, just before printing.
- To avoid curling, when you do not print, put unused paper back into the package and keep it on a level surface. And also, store it avoiding heat, humidity, and direct sunlight.

# Paper Load Limit

## Commercially Available Papers

Media Name	Cassette (upper)	Cassette (lower)	Paper Output Tray
Plain Paper (including recycled paper) <sup>*1</sup>	N/A <sup>*2</sup>	Approx. 125 sheets	Approx. 50 sheets
Envelopes	N/A <sup>*2</sup>	10 envelopes	<sup>*3</sup>

## Canon Genuine Papers

### ►► Note

- We recommend that you remove the previously printed sheet from the paper output tray before continuously printing to avoid blurs and discoloration (except for High Resolution Paper <HR-101N>).

### Paper for printing photos:

Media Name <Model No.>	Cassette (upper)	Cassette (lower)
Photo Paper Pro Platinum <PT-101> <sup>*4</sup>	20 sheets: 4" x 6" (10 x 15 cm)	10 sheets: A4, Letter, and 8" x 10" (20 x 25 cm)
Glossy Photo Paper "Everyday Use" <GP-501/GP-601> <sup>*4</sup>	20 sheets: 4" x 6" (10 x 15 cm)	10 sheets: A4 and Letter
Photo Paper Glossy <GP-601> <sup>*4</sup>	20 sheets: 4" x 6" (10 x 15 cm)	10 sheets: A4 and Letter
Photo Paper Plus Glossy II <PP-201> <sup>*4</sup>	10 sheets: 5" x 7" (13 x 18 cm) 20 sheets: 4" x 6" (10 x 15 cm)	10 sheets: A4, Letter, and 8" x 10" (20 x 25 cm)
Photo Paper Pro Luster <LU-101> <sup>*4</sup>	N/A <sup>*2</sup>	10 sheets: A4 and Letter
Photo Paper Plus Semi-gloss <SG-201> <sup>*4</sup>	10 sheets: 5" x 7" (13 x 18 cm) 20 sheets: 4" x 6" (10 x 15 cm)	10 sheets: A4, Letter, and 8" x 10" (20 x 25 cm)
Matte Photo Paper <MP-101>	20 sheets: 4" x 6" (10 x 15 cm)	10 sheets: A4 and Letter

## Paper for printing business documents:

Media Name <Model No.>	Cassette (upper)	Cassette (lower)	Paper Output Tray
High Resolution Paper <HR-101N>	N/A <sup>*2</sup>	65 sheets	50 sheets

## Paper for creating your own prints:

Media Name <Model No.>	Cassette (upper)	Cassette (lower)
T-Shirt Transfers <TR-301>	N/A <sup>*2</sup>	1 sheet
Photo Stickers <PS-101>	1 sheet	N/A <sup>*5</sup>

\*1 Proper feeding of paper may not be possible at the maximum capacity depending on the type of paper or environmental conditions (either very high or low temperature or humidity). In such cases, reduce the number of paper you load at a time to less than half.

\*2 Feeding paper from the cassette (upper) can damage the machine. Always load in the cassette (lower).

\*3 We recommend that you remove the previously printed envelope from the paper output tray before continuously printing to avoid blurs and discoloration.

\*4 When loading paper in stacks, the print side may become marked as it is fed or paper may not feed properly. In this case, load one sheet at a time.

\*5 Feeding paper from the cassette (lower) can damage the machine. Always load in the cassette (upper).

## Media Type Settings on the Operation Panel

### Commercially Available Papers

Media Name	Settings in Type
Plain Paper (including recycled paper)	Plain paper

### Canon Genuine Papers

#### Paper for printing photos:

Media Name <Model No.>	Settings in Type
Photo Paper Pro Platinum <PT-101>	Pro Platinum
Glossy Photo Paper "Everyday Use" <GP-501/GP-601>	Glossy
Photo Paper Glossy <GP-601>	Glossy
Photo Paper Plus Glossy II <PP-201>	Plus Glossy II
Photo Paper Pro Luster <LU-101>	Plus Semi-gloss
Photo Paper Plus Semi-gloss <SG-201>	Plus Semi-gloss
Matte Photo Paper <MP-101>	Matte



## Media Types You Cannot Use

Do not use the following types of paper. Using such paper will cause not only unsatisfactory results, but also the machine to jam or malfunction.

- Folded, curled, or wrinkled paper
- Damp paper
- Paper that is too thin (weighing less than 17 lb (64 g /m<sup>2</sup>))
- Paper that is too thick (weighing more than 28 lb (105 g /m<sup>2</sup>), except for Canon genuine paper)
- Paper thinner than a postcard, including plain paper or notepad paper cut to a small size (when printing on paper smaller than A5)
- Picture postcards
- Postcards affixed with photos or stickers
- Envelopes with a double flap
- Envelopes with an embossed or treated surface
- Envelopes whose gummed flaps are already moistened and adhesive
- Any type of paper with holes
- Paper that is not rectangular
- Paper bound with staples or glue
- Paper with adhesives
- Paper decorated with glitter, etc.

## Before Printing on Art Paper

When using art paper, dust is liable to be generated. It is therefore recommended that paper dust be removed on art paper just before printing.

### You will need a soft hair brush (or similar brush used to clean office automation equipment).

The wider the brush, the more effective it will be.



OK - soft brush made from material such as polypropylene, polyethylene, horse hair or goat hair.

#### »» Important

- Be sure not to use brushes as shown below. The printing surface may be damaged.



Not OK - brush made from hard material, cloth or washcloth, sticky and abrasive materials.

### Paper dust removal procedure:

1. Check that the brush is not wet and free from dust or dirt.
2. Brush the overall printing surface carefully in one direction.

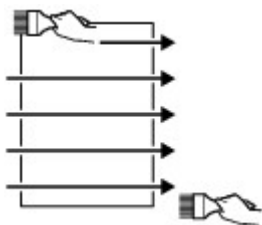

#### »» Important

- Be sure to brush all the way across the paper; do not start brushing at the middle or stop halfway.
- Be careful not to touch the printing surface as much as possible.

3. To complete the removal of paper dust, brush the paper in the other direction from top to bottom.

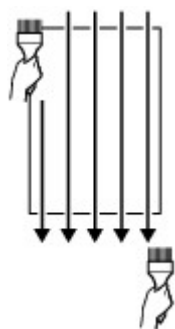

# Printing Area

- [Printing Area](#)
- [Other Sizes than Letter, Legal, Envelopes](#)
- [Letter, Legal](#)
- [Sizes for Art Paper](#)
- [Envelopes](#)
- [Printable Discs](#)

# Printing Area

To ensure the best print quality, the machine allows a margin along each edge of media. The actual printable area will be the area inside these margins.

Recommended printing area  : Canon recommends that you print within this area.

Printable area  : The area where it is possible to print.

However, printing in this area can affect the print quality or the paper feed precision.

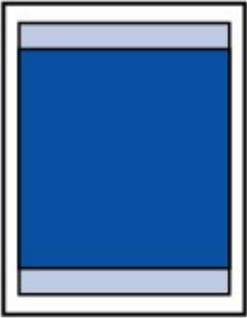

## »» Note

- With performing Automatic Duplex Printing and Duplex (Two-sided) Copying, the printable area will be 0.08 inches (2 mm) smaller at the top margin.
- When performing borderless copying or borderless printing from a printed photo, select **Extended copy amount** in **Print settings** of **Device settings** to specify the amount of images that extends off the paper.

➔ [Print settings](#)

## Borderless Printing

- By selecting Borderless Printing option, you can make prints with no margins.
- When performing Borderless Printing, slight cropping may occur at the edges since the printed image is enlarged to fill the whole page.
- For Borderless Printing, use the following paper:
  - Photo Paper Pro Platinum <PT-101>
  - Glossy Photo Paper "Everyday Use" <GP-501/GP-601>
  - Photo Paper Glossy <GP-601>
  - Photo Paper Plus Glossy II <PP-201>
  - Photo Paper Pro Luster <LU-101>
  - Photo Paper Plus Semi-gloss <SG-201>
  - Matte Photo Paper <MP-101>

Performing Borderless Printing on any other type of paper may substantially reduce printing quality and/or result in printouts with altered color hues.

Borderless Printing on plain paper may result in printouts with reduced quality. Use them only for test printing. Borderless Printing onto plain paper from the operation panel or from a digital camera is not supported.

- Borderless Printing is not available for legal, A5, or B5 sized paper, envelopes, or non-Canon genuine art paper.
  - Depending on the type of paper, Borderless Printing may reduce the print quality at the top and bottom edges of the paper or cause these parts to become smudged.
-

## Other Sizes than Letter, Legal, Envelopes

Size	Printable Area (width x height)
A5	5.56 x 7.95 inches (141.2 x 202.0 mm)
A4	8.00 x 11.38 inches (203.2 x 289.0 mm)
B5	6.90 x 9.80 inches (175.2 x 249.0 mm)
4" x 6" (10 x 15 cm)	3.73 x 5.69 inches (94.8 x 144.4 mm)
5" x 7" (13 x 18 cm)	4.73 x 6.69 inches (120.2 x 169.8 mm)
8" x 10" (20 x 25 cm)	7.73 x 9.69 inches (196.4 x 246.0 mm)

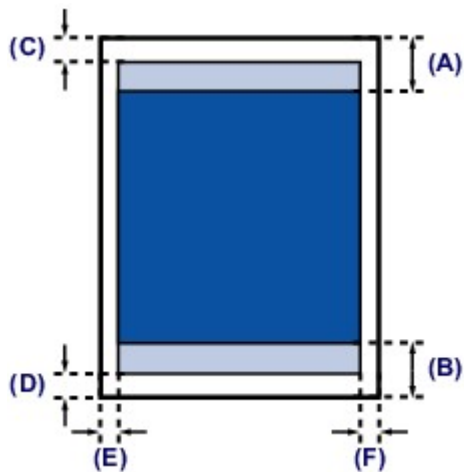

■ Recommended printing area

(A) 1.59 inches (40.4 mm)

(B) 1.47 inches (37.4 mm)

■ Printable area

(C) 0.12 inches (3.0 mm)

(D) 0.20 inches (5.0 mm)

(E) 0.13 inches (3.4 mm)

(F) 0.13 inches (3.4 mm)

## Letter, Legal

Size	Printable Area (width x height)
Letter	8.00 x 10.69 inches (203.2 x 271.4 mm)
Legal	8.00 x 13.69 inches (203.2 x 347.6 mm)

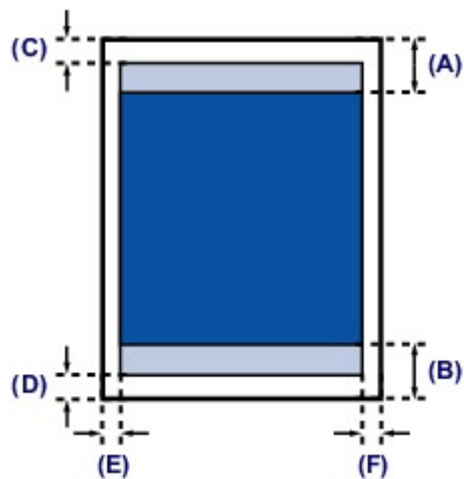

■ Recommended printing area

(A) 1.59 inches (40.4 mm)

(B) 1.47 inches (37.4 mm)

□ Printable area

(C) 0.12 inches (3.0 mm)

(D) 0.20 inches (5.0 mm)

(E) 0.25 inches (6.4 mm)

(F) 0.25 inches (6.3 mm)



## Sizes for Art Paper

A limit is set to prevent printing along a 1.38 inch (35 mm) margin on the top and bottom edges when a paper size for art paper is selected in the printer driver. We recommend checking the printing area in the preview screen before printing.

### A4

Size	Recommended Printing Area (width x height)
A4 (art paper, 1.38 inch (35 mm) margin)	8.00 x 8.94 inches (203.2 x 227.0 mm)

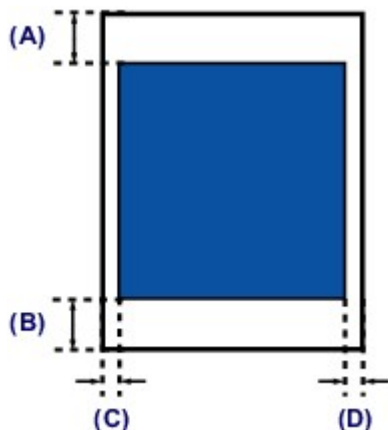

■ Recommended printing area

(A) 1.38 inches (35.0 mm)

(B) 1.38 inches (35.0 mm)

(C) 0.13 inches (3.4 mm)

(D) 0.13 inches (3.4 mm)

### Letter

Size	Recommended Printing Area (width x height)
Letter (art paper, 1.38 inch (35 mm) margin)	8.00 x 8.24 inches (203.2 x 209.4 mm)

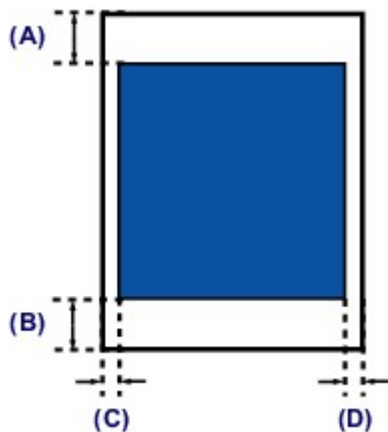

■ Recommended printing area

(A) 1.38 inches (35.0 mm)

**(B)** 1.38 inches (35.0 mm)

**(C)** 0.25 inches (6.4 mm)

**(D)** 0.25 inches (6.3 mm)

# Envelopes

Size	Recommended Printing Area (width x height)
Envelope DL	3.88 x 7.07 inches (98.8 x 179.6 mm)
Envelope Com 10	3.68 x 7.90 inches (93.5 x 200.9 mm)

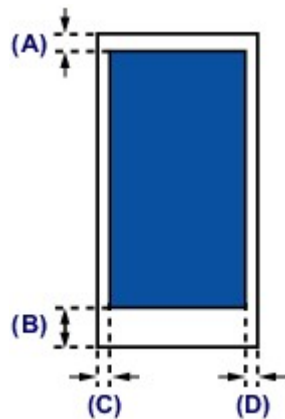

■ Recommended printing area

(A) 0.12 inches (3.0 mm)

(B) 1.47 inches (37.4 mm)

(C) 0.22 inches (5.6 mm)

(D) 0.22 inches (5.6 mm)

## Printable Discs

The printing area of the printable disc is from 0.67 inches (17 mm) of the internal diameter to 0.04 inches (1 mm) from the external diameter of the printing surface.

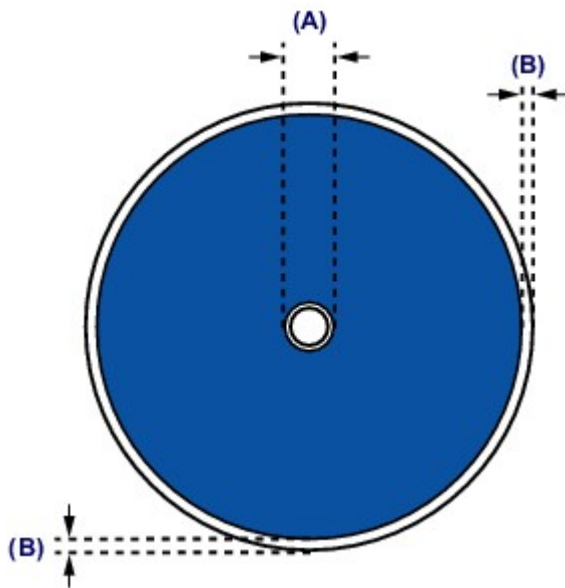

 Recommended printing area

**(A)** 0.67 inches (17.0 mm)

**(B)** 0.04 inches (1.0 mm)

## Placing a Printable Disc

- [Cautions When Printing on a Printable Disc](#)
- [Before Placing a Printable Disc](#)
- [Placing a Printable Disc](#)
- [Removing a Printable Disc](#)
- [How to Detach / Attach the Disc Tray](#)

## Cautions When Printing on a Printable Disc

- Be sure to use the disc tray supplied with this machine. It has a "J" on the upper side.
- Do not print on printable discs that are not compatible with inkjet printing. The ink will not dry and may cause problems with the disc itself or devices which the disc is loaded onto.
- Do not print on the printable discs' recording surface. Doing so will make data recorded on discs unreadable.
- Hold the printable discs by their edges. Do not touch either the label surface (printing surface) or recording surface.
- Remove any dirt from the disc tray before placing printable discs on the disc tray. Loading discs in a dirty disc tray may scratch the recording surface of the discs.
- After printing, allow the printing surface of the disc to dry naturally. Do not use hairdryers or expose the disc to direct sunlight to dry the ink. Do not touch the printing surface until the ink has dried.
- Do not attach the disc tray while the machine is in operation.
- Do not remove the disc tray while printing on printable discs. Doing so may damage the machine, the disc tray, or the disc.
- Do not get dirt or scratches on the reflectors of the disc tray. The machine may not be able to recognize loading of the printable disc, or printing may become misaligned. If the reflectors on the disc tray become dirty, wipe the reflector clean with a soft and dry cloth, taking care not to scratch the plate.
- The disc tray may become dirty if software other than My Image Garden is used.
- Always close the inner cover after printing on printable discs.
- To keep the print quality at an optimal level, it is recommended to stop printing discs once every ten discs when printing more than ten discs continuously.  
To stop the printing operation, detach the disc tray from the machine, then close the inner cover. After approximately three minutes have elapsed, open the inner cover, attach the disc tray to the machine, then resume printing.

## Before Placing a Printable Disc

The following items are needed to print onto the printable disc:

- disc tray (supplied with the machine)



\* Use the disc tray with "J" on the surface.

The disc tray is attached in the back of the cassette (upper).

➔ [How to Detach / Attach the Disc Tray](#)

- 4.72 inches (12 cm) printable disc



Obtain a printable disc with a label surface compatible with inkjet printing.

### ➤➤ Note

- A "printable disc" differs from regular disc (BD/DVD/CD, etc.) in that its label surface has been specially processed to be printed on by an inkjet printer.

## Placing a Printable Disc

To print onto a printable disc, place it on the disc tray supplied with the machine, then insert it into the machine.

This procedure also applies to printing from a computer.

### »» Important

- Do not attach the disc tray until the message asking you to load the printable disc is displayed. Doing so can damage the machine.

1. Detach the disc tray from the cassette (upper).

➔ [How to Detach / Attach the Disc Tray](#)

2. Holding both sides of the paper output tray **(A)**, gently open it.

3. When the message asking you to load the printable disc is displayed, open the inner cover **(B)** and push it down all the way to the bottom.

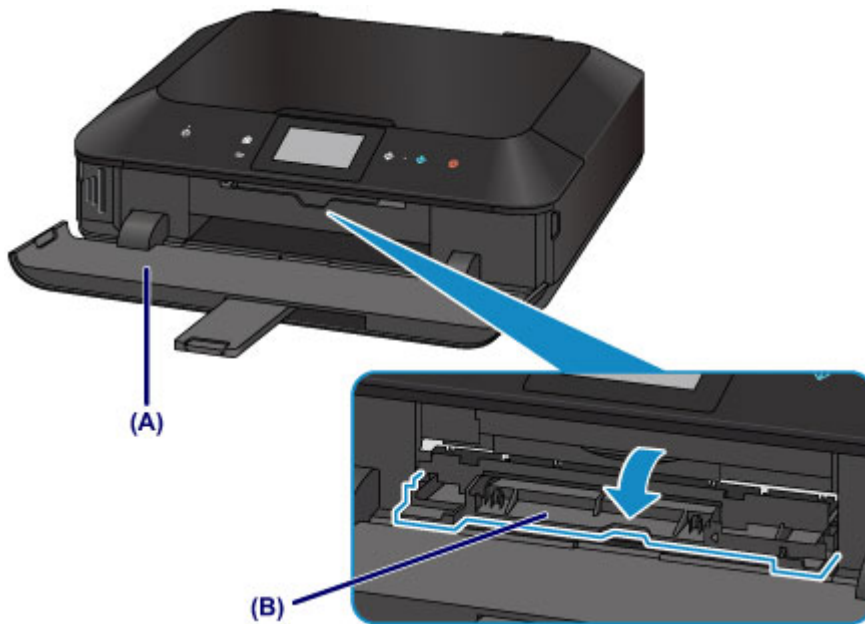

4. Place the printable disc with the printable surface facing up.

### »» Important

- Make sure that there is no dirt on the disc tray before placing a printable disc on the disc tray.
- When placing a printable disc on the disc tray, do not touch the printing surface of the disc or the reflectors **(C)** on the disc tray.



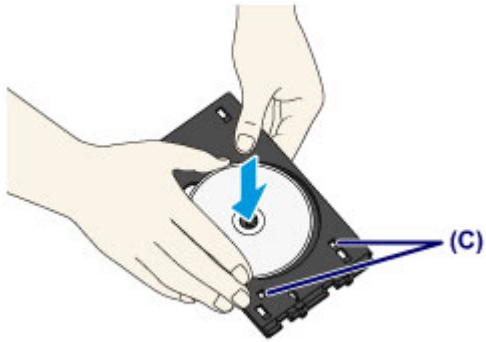

## 5. Attach the disc tray to the machine.

### »» Note

- The disc tray may be ejected after a specified period of time has elapsed. In this case, follow the on-screen instructions to attach the disc tray.

(1) Place the disc tray on the inner cover.

(2) Insert the disc tray straight until the arrow (◀) on the inner cover is almost aligned with the arrow (▶) on the disc tray.

### »» Important

- Do not insert the disc tray beyond the arrow (◀) on the inner cover.

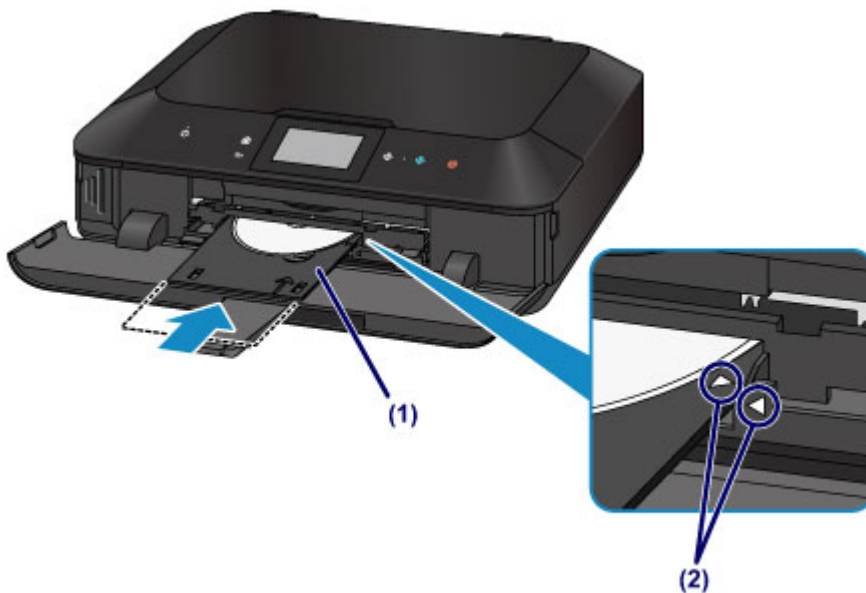

## Removing a Printable Disc

1. Pull out the disc tray.



2. Close the inner cover.

### ►► Important

- If the inner cover is opened, you cannot print on paper as it will not feed properly. Make sure that the inner cover is closed.



3. Remove the printable disc from the disc tray.

### ►► Important

- Do not touch the printing surface when removing the disc from the disc tray.

## ►►► Note

- Dry the printing surface sufficiently before removing the disc. If you see printing on the disc tray or the transparent parts on inner or outer diameter of the printable disc, wipe them off after the printing surface has dried.

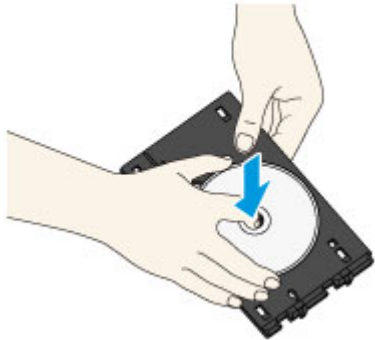

4. Close the paper output tray.
5. Attach the disc tray onto the cassette (upper).  
➔ [How to Detach / Attach the Disc Tray](#)

# How to Detach / Attach the Disc Tray

## Detaching the disc tray

Slide the disc tray to the side on the back of the cassette (upper) and raise it to detach.

### »» Important

- Be sure to remove all orange shipping tapes on the disc tray.

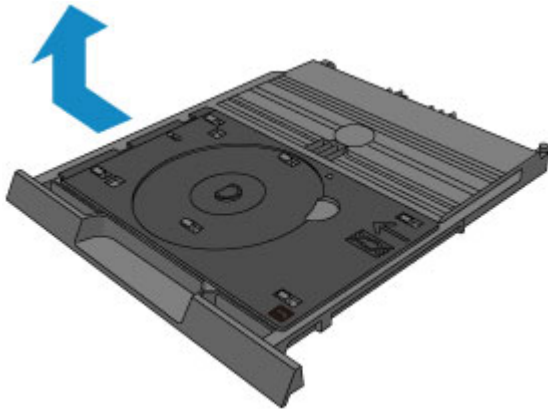

## Attaching the disc tray

Align the holes of the disc tray with the hooks on the back of the cassette (upper) and slide it to attach.

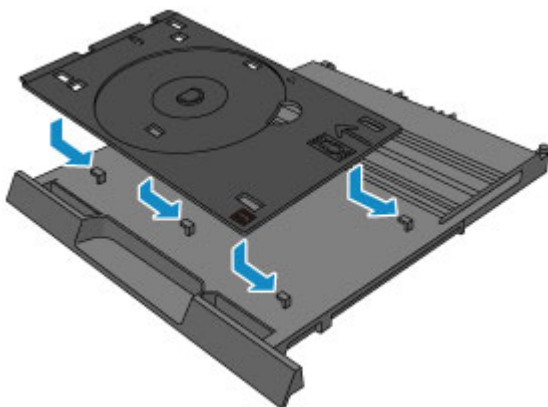

### »» Important

- Be sure to align each hole of the disc tray with its corresponding hook on the back of the cassette (upper). If the disc tray is not attached properly, the disc tray may be damaged during insertion of the cassette (upper) into the machine.

# Loading Originals

- Loading Originals on the Platen Glass
- How to Load Originals for Each Function
- Originals You Can Load
- How to Detach / Attach the Document Cover

# Loading Originals on the Platen Glass

You can load originals to copy or scan on the platen glass.

1. Load an original on the platen glass.

(1) Open the document cover.

(2) Load the original WITH THE SIDE TO SCAN FACING DOWN on the platen glass.

➔ [Originals You Can Load](#)

Make sure of the proper position to load the original for each function.

➔ [How to Load Originals for Each Function](#)



## ►► Important

- Be sure to observe the following when loading the original on the platen glass.
  - Do not place any objects weighing 4.4 lb (2.0 kg) or more on the platen glass.
  - Do not put any pressure of 4.4 lb (2.0 kg) or more on the platen glass, such as pressing down the original.

Failure to observe the above may cause the scanner to malfunction or the platen glass to break.

2. Close the document cover gently.

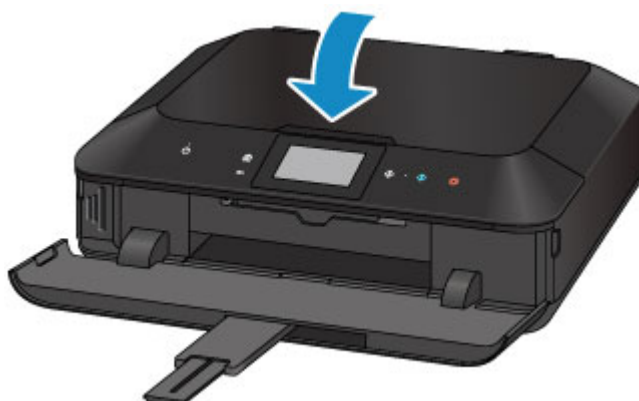

## »» Important

- After loading the original on the platen glass, be sure to close the document cover before starting to copy or scan.

## How to Load Originals for Each Function

You may have to load the original in a different position depending on the function you selected in copying, scanning, etc. Load the original in the correct position according to the selected function. If you do not load the original correctly, it may not be scanned properly.

### Loading the Original to Be Aligned with the alignment mark

- Load originals to copy
- In Scan,
  - select **Auto scan for Doc.type** to scan text documents, magazines, or newspapers
  - select **Document or Photo for Doc.type** and specify a standard size (**A4, Letter, etc.**) for **Scan size** to scan originals
- With a software application on a computer,
  - scan text documents, magazines, or newspapers
  - select a standard size (**A4, Letter, etc.**) to scan originals

Load the original WITH THE SIDE TO SCAN FACING DOWN and align it with the alignment mark .



### ►►► Important

- The machine cannot scan the shaded area **(A)** (0.04 inches (1 mm) from the edges of the platen glass).

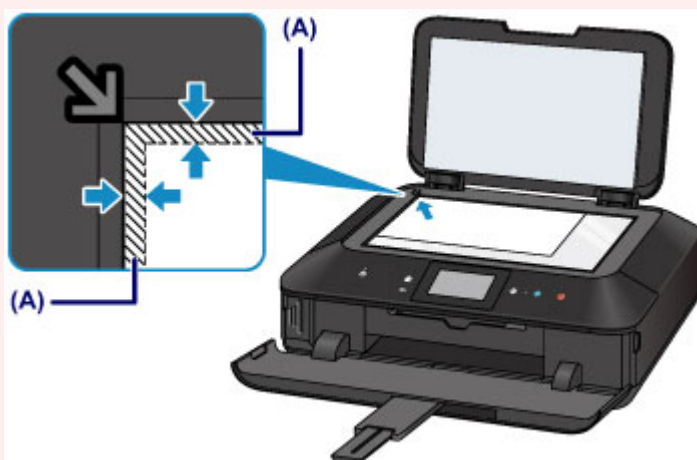

### Loading Only One Original in the Center of the platen glass

- Scan only one disc in Copy label to disc label



- **Scan only one printed photo in Photo copy**
- **In Scan,**
  - select **Auto scan for Doc.type** to scan one printed photo, postcard, business card, or disc
  - select **Photo for Doc.type** and specify **Auto scan for Scan size** to scan one original
- **Scan one printed photo, postcard, business card, or disc with a software application on a computer**

Load the original WITH THE SIDE TO SCAN FACING DOWN and place it at least 0.4 inches (10 mm) away from the edges of the platen glass.

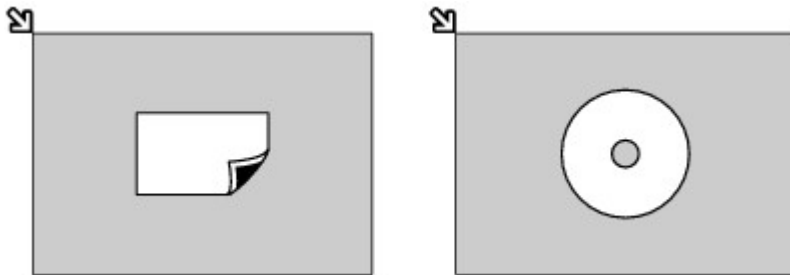

## Loading Two or More Originals on the platen glass

- **Scan two or more printed photos in Photo copy**
- **In Scan,**
  - select **Auto scan for Doc.type** to scan two or more printed photos, postcards, or business cards
  - select **Photo for Doc.type** and specify **Auto multi scan for Scan size** to scan two or more originals
- **Scan two or more printed photos, postcards, or business cards with a software application on a computer**

Load two or more originals WITH THE SIDE TO SCAN FACING DOWN and place them at least 0.4 inches (10 mm) away from the edges of the platen glass and at least 0.4 inches (10 mm) apart from each other.

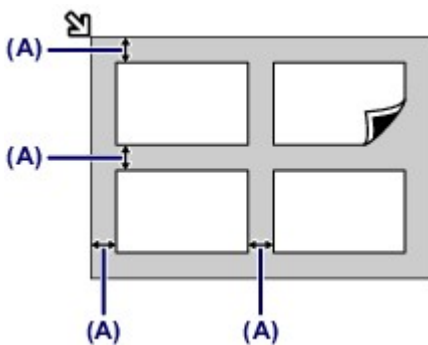

**(A)** 0.4 inches (10 mm)

## ►► Note

---

- The Skew Correction function automatically compensates for the originals placed at an angle of up to approximately 10 degrees. Slanted photos with a long edge of 7.1 inches (180 mm) or more cannot be corrected.
  - Non-rectangular or irregular shaped photos (such as cut out photos) may not be scanned properly.
-

## Originals You Can Load

The originals you can load on the platen glass are as follows.

Item	Details
<b>Types of originals</b>	- Text document, magazine, or newspaper - Printed photo, postcard, business card, or disc (BD/DVD/CD, etc.)
<b>Size (width x height)</b>	Max. 8.5 x 11.7 inches (216 x 297 mm)

### ▶▶▶ Note

- When loading a thick original such as a book on the platen glass, you can load it by removing the document cover from the machine.  
➔ [How to Detach / Attach the Document Cover](#)

## How to Detach / Attach the Document Cover

### Detaching the document cover:

Hold up the document cover vertically and then tip it back.



### Attaching the document cover:

Fit both hinges (A) of the document cover into the holder (B) and insert both hinges of the document cover vertically as illustrated below.



# Inserting the Memory Card

- [Before Inserting the Memory Card](#)
- [Inserting the Memory Card](#)
- [Removing the Memory Card](#)

## Before Inserting the Memory Card



The following types of memory cards and image data are compatible with the machine.

### »» Important

#### Image data shot by the digital camera

- If you took and saved photos on a type of memory card that does not guarantee the operation on your digital camera, the image data may be unreadable on the machine or damaged. For information on memory cards that your digital camera guarantees operation, refer to the instruction manual supplied with your digital camera.
- Format the memory card with a digital camera compliant with the Design rule for Camera File system (Exif 2.2/2.21/2.3 compliant), TIFF (Exif 2.2/2.21/2.3 compliant). The memory card may not be compatible with the machine if it is formatted on a computer.



## Memory Cards that Do Not Require a Card Adapter

	SD Secure Digital memory card SDHC memory card
	Compact Flash (CF) Card (Supports Type I/II (3.3 V)) Microdrive
	Memory Stick Duo Memory Stick PRO Duo

## Memory Cards that Require a Card Adapter

### »» Important

- Be sure to attach the special card adapters to the following memory cards before inserting to the card slot.  
If one of the following memory cards is inserted without the card adapter, you may not be able to remove the memory card.
- ➔ Cannot Remove a Memory Card

	miniSD Card <sup>*1</sup> miniSDHC Card <sup>*1</sup>
	microSD Card <sup>*1</sup> microSDHC Card <sup>*1</sup>
	xD-Picture Card <sup>*2</sup>

	xD-Picture Card Type M <sup>*2</sup> xD-Picture Card Type H <sup>*2</sup>
	Memory Stick Micro <sup>*3</sup>

\*1 Use the special "SD Card Adapter".

\*2 Requires purchase of a separate compact flash card adapter for xD-Picture Card.

\*3 Use the special Duo size adapter.

## Printable Image Data

- This machine accepts images taken with a camera compliant with the Design rule for Camera File system (Exif 2.2/2.21/2.3 compliant), TIFF (Exif 2.2/2.21/2.3 compliant). Other image or movie types such as RAW images cannot be printed.
- The machine accepts images scanned and saved with the machine when **Doc.type** is set to **Photo** and **Format** is set to **JPEG** (file extension ".jpg").

### ▶▶▶ Note

- This device incorporates exFAT technology licensed from Microsoft.

# Inserting the Memory Card

## ►► Important

- When a memory card is inserted into the card slot, the **Access** lamp is lit. When the **Access** lamp is flashing, the machine is accessing the memory card. In this case, do not touch the area around the card slot.

## ►► Note

- When **Read/write attribute** is set to **Writable from USB PC** or **Writable from LAN PC**, you cannot print image data from the memory card or save scanned data on the memory card using the operation panel of the machine. After using the card slot as the memory card drive of a computer, remove the memory card, select **Device user settings** in **Device settings** of **Setup** on the HOME screen, then set **Read/write attribute** to **Not writable from PC**.
  - ➔ [Setting Up the Card Slot as the Memory Card Drive of the Computer](#)
- When you use a computer to edit or enhance photos saved on a memory card, be sure to print them from the computer. If you use the operation panel, the photos may not be printed properly.

### 1. Prepare your memory card.

Attach a special card adapter if your memory card requires one.

➔ [Before Inserting the Memory Card](#)

### 2. Turn on the power, then, holding both sides of the paper output tray, gently open it.



### 3. Insert only one memory card into the card slot.

The location to insert a memory card varies depending on each type of memory card. Insert your memory card straightforward WITH THE LABELED SIDE FACING TO THE LEFT into the card slot, according to the insert location in the figure below.

When the memory card is inserted properly, the **Access** lamp (**A**) will light up.



Be sure to attach the card adapter for memory card with the mark \* (asterisk), and then insert it into the card slot as shown below.

**Insert the following types of memory cards into the left card slot:**

- Memory Stick Duo, Memory Stick PRO Duo
- Memory Stick Micro (with the Duo size adapter)\*

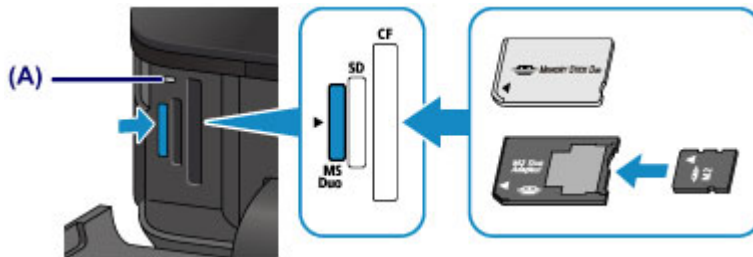

**Insert the following types of memory cards into the center card slot:**

- SD Secure Digital memory card, SDHC memory card
- miniSD Card\*, miniSDHC Card\*
- microSD Card\*, microSDHC Card\*

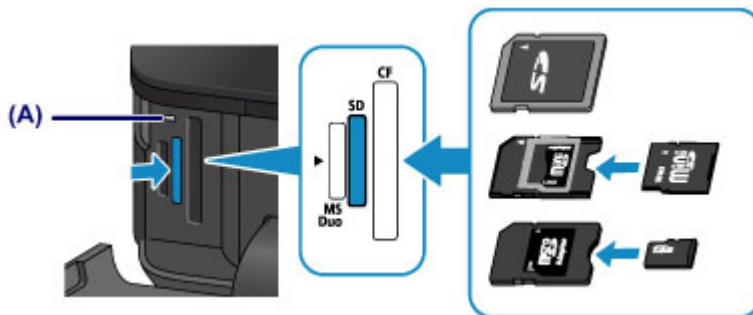

**Insert the following types of memory cards into the right card slot:**

- Compact Flash (CF) Card, Microdrive
- xD-Picture Card\*, xD-Picture Card Type M\*, xD-Picture Card Type H\*

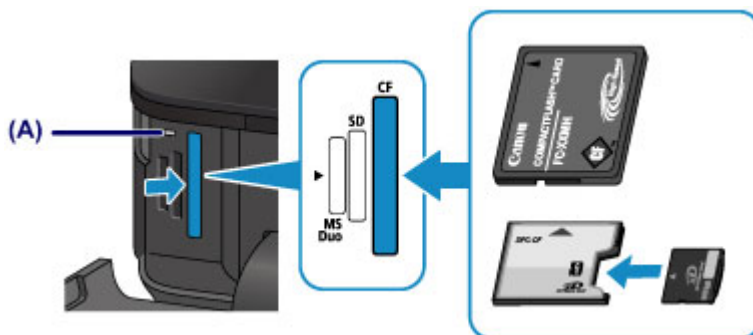

## »» Important

- Part of the memory card will protrude from the card slot, but do not force it into the slot any further. This can damage the machine or the memory card.
- Make sure that the memory card is correctly oriented before inserting it into the card slot. If you force the memory card into the card slot in the wrong orientation, the memory card or the machine can be damaged.
- Do not insert more than one memory card at a time.

4. Close the paper output tray.

# Removing the Memory Card

## »» Important

- If you used the card slot as the memory card drive of a computer, you must perform the "safe removal" operation on your computer before physically removing the memory card from the machine.

➔ [Setting Up the Card Slot as the Memory Card Drive of the Computer](#)

1. Holding both sides of the paper output tray, gently open it.
2. Make sure that the **Access** lamp is lit, and remove the memory card.

Hold the part of the memory card that is protruding and remove it straightforward from the machine.

## »» Important

- Do not remove the memory card while the **Access** lamp is flashing. The **Access** lamp flashes while the machine is reading or writing data from/to the memory card. If you remove the memory card or turn off the power while the **Access** lamp is flashing, the data saved on the memory card can be damaged.

3. Close the paper output tray.

# Replacing an Ink Tank

- Replacing an Ink Tank
- Checking the Ink Status

# Replacing an Ink Tank

When remaining ink cautions or errors occur, the message will appear on the touch screen to inform you of the error. Take appropriate action according to the message.

➔ A Message Is Displayed

## »» Note

- For information on the compatible ink tank, refer to the printed manual: *Safety and Important Information*.
- If print results become faint or white streaks appear despite sufficient ink levels, see [Maintenance Procedure](#).

## Replacing Procedure

When you need to replace an ink tank, follow the procedure below.

➔ Watch the movie

## »» Important

### Handling ink

- If you remove an ink tank, replace it immediately. Do not leave the machine with the ink tank removed.
- Use a new ink tank for replacement. Installing a used ink tank may cause the nozzles to clog. Furthermore, with such an ink tank, the machine will not be able to inform you when to replace the ink tank properly.
- Once an ink tank has been installed, do not remove it from the machine and leave it out in the open. This will cause the ink tank to dry out, and the machine may not operate properly when it is reinstalled. To maintain optimal printing quality, use an ink tank within six months of first use.

## »» Note

- Color ink may be consumed even when printing a black-and-white document or when black-and-white printing is specified.  
Every ink is also consumed in the standard cleaning and deep cleaning of the print head, which may be necessary to maintain the performance of the machine. When an ink tank is out of ink, replace it immediately with a new one.

➔ [Useful Information about Ink](#)

1. Make sure that the power is turned on, then, holding both sides of the paper output tray, gently open it.
2. Lift the operation panel and open until it stops.  
The print head holder moves to the replacement position.

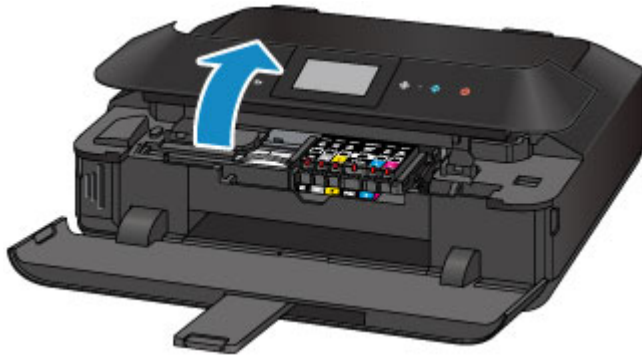

### **⚠ Caution**

- Do not hold the print head holder to stop or move it forcibly. Do not touch the print head holder until it stops completely.

### **➤➤ Important**

- When opening or closing the operation panel, do not touch the buttons and touch screen on the operation panel. Doing so may result in an unexpected operation.
- Do not touch the metallic parts or other parts inside the machine.
- If the operation panel is left open for more than 10 minutes, the print head holder moves to the right. In this case, close and reopen the operation panel.

## **3. Remove the ink tank with the lamp flashing fast.**

Push the tab **(A)** and lift the ink tank to remove.

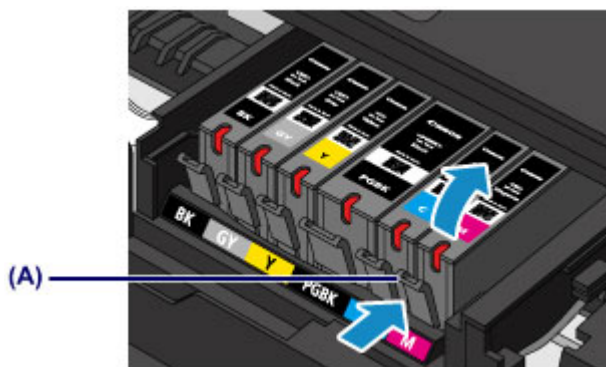

### **➤➤ Important**

- Do not touch other parts besides the ink tanks.
- Handle the ink tank carefully to avoid staining of clothing or the surrounding area.
- Discard the empty ink tank according to the local laws and regulations regarding disposal of consumables.

### **➤➤ Note**

- Do not remove two or more ink tanks at the same time. Be sure to replace ink tanks one by one when replacing two or more ink tanks.

- For details on ink lamp flashing speed, see [Checking the Ink Status with the Ink Lamps](#).

#### 4. Prepare a new ink tank.

- (1) Take a new ink tank out of its package, remove the orange tape (1) completely, then remove the protective film (2) completely.

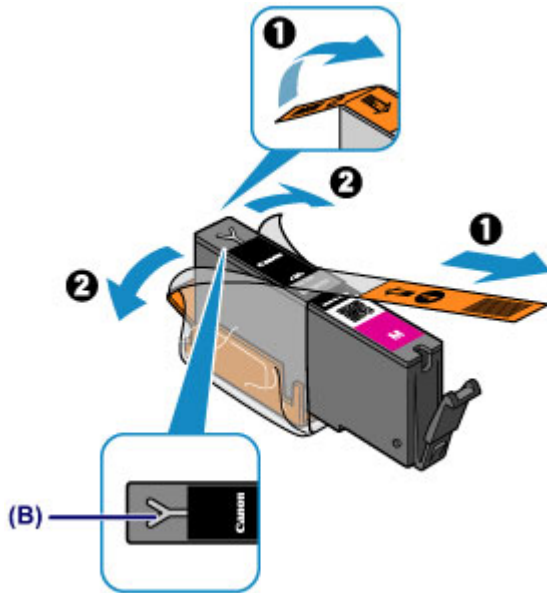

#### ►► Important

- Handle an ink tank carefully. Do not drop or apply excessive pressure to it.
- If the orange tape remains on the Y-shape air hole (B), ink may splash or the machine may not print properly.

- (2) Hold the ink tank with the orange protective cap (C) pointing up while being careful not to block the Y-shape air hole (B).

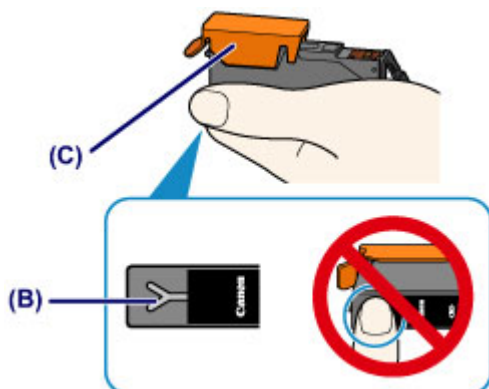

- (3) Lift up the tab on the orange protective cap (C) to remove it off GENTLY.

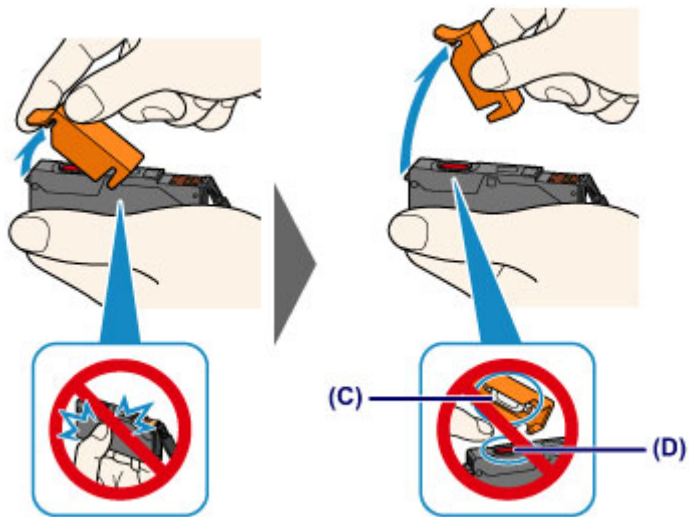

### »»» Important

- Do not push the sides of the ink tank. If you push the sides of the ink tank with the Y-shape air hole **(B)** blocked, ink may splash.
- Do not touch the inside of the orange protective cap **(C)** or the open ink port **(D)**. The ink may stain your hands if you touch them.
- Do not reattach the protective cap **(C)** once you have removed it. Discard it according to the local laws and regulations regarding disposal of consumables.

## 5. Install the new ink tank.

### (1) Insert the front end of the ink tank into the print head at a slant.

Make sure that the position of the ink tank matches the label.

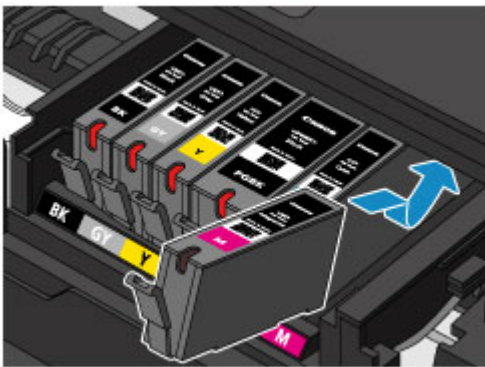

### (2) Press on the top of the ink tank until the ink tank snaps firmly into place.

Make sure that the ink lamp lights up red.



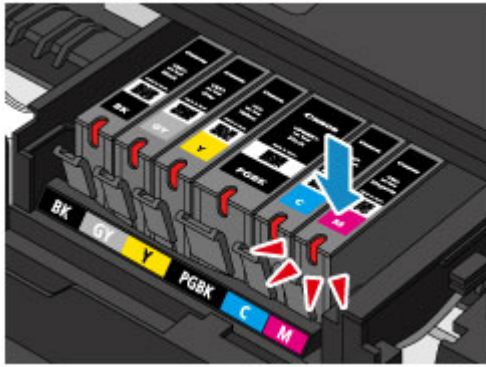

### ►► Important

- You cannot print if the ink tank is installed in the wrong position. Be sure to install the ink tank in the correct position according to the label on the print head holder.
- You cannot print unless all the ink tanks are installed. Be sure to install all the ink tanks.

## 6. Close the operation panel gently.

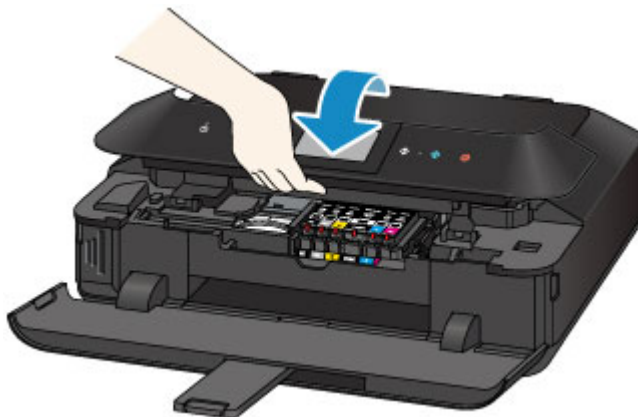

### ⚠ Caution

- When closing the operation panel, be careful not to get your fingers caught.

### ►► Important

- When opening or closing the operation panel, do not touch the buttons and touch screen on the operation panel. Doing so may result in an unexpected operation.

### ►► Note

- If the error message appears after the operation panel is closed, take appropriate action.
  - ➔ A Message Is Displayed
- When you start printing after replacing the ink tank, the machine starts cleaning the print head automatically. Do not perform any other operations until the machine completes the cleaning of the print head.

- If the print head is out of alignment, as indicated by misaligned printed ruled lines or similar symptoms, adjust the print head position.
    - ➡ [Aligning the Print Head](#)
  - The machine may make noise during operation.
-

# Checking the Ink Status

- [Checking the Ink Status with the Touch Screen on the Machine](#)
- [Checking the Ink Status with the Ink Lamps](#)

You can also check the ink status on the computer screen.

- [Checking the Ink Status from Your Computer](#)

# Checking the Ink Status with the Touch Screen on the Machine

1. Make sure that the power is turned on, and display the HOME screen.  
If the HOME screen is not displayed, touch the **HOME** button to display it.

2. Flick the HOME screen, then tap  **Setup**.

➔ [Using the Operation Panel](#)

The setup menu screen will appear.

3. Tap  **Estimated ink levels**.

A symbol appears in the area (A) if there is any information about the remaining ink level.



Example: 

Ink tank is running low. Prepare a new ink tank.

## ➤➤➤ Note

- The above screen shows estimated ink levels.
- Touch the **HOME** button to exit **Setup** and display the HOME screen.
- To display and print the model number of the ink tank, tap **Ink number**.
- You can also check the ink status on a screen of the touch screen displayed while printing.
- You can also check the ink status on the computer screen.  
➔ [Checking the Ink Status from Your Computer](#)

# Checking the Ink Status with the Ink Lamps

1. Make sure that the power is turned on, then, holding both sides of the paper output tray, gently open it.

2. Lift the operation panel and open until it stops.

➔ [Replacing Procedure](#)

3. Check the ink lamp.

Close the operation panel after checking the ink lamp status.

➔ [Replacing Procedure](#)

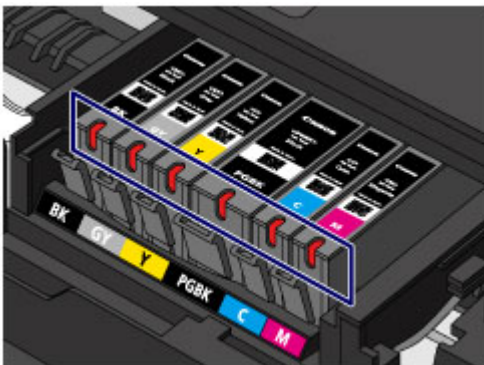

● The ink lamp is on.  
The ink tank is correctly installed.

● The ink lamp is flashing.

**Flashing slowly (at around 3-second intervals)**

● ● ..... Repeats

Ink tank is running low. Prepare a new ink tank.

**Flashing fast (at around 1-second intervals)**

● ● ● ● ● ..... Repeats

- The ink tank is installed in the wrong position.

Or

- The ink has run out.

Make sure that the ink tank is installed in the correct position as indicated by the label on the print head holder. If the position is correct but the lamp flashes, there has been an error and the machine cannot print. Check the error message displayed on the touch screen.

➔ [A Message Is Displayed](#)

- The ink lamp is off.

The ink tank is not installed properly or the function for detecting the remaining ink level is disabled. If the ink tank is not firmly in place, make sure that the orange protective cap has been removed from the bottom of the ink tank, then press on the top of the ink tank until the ink tank clicks into place.

If the ink lamp is still off after reinstalling the ink tank, there has been an error and the machine cannot print. Check the error message displayed on the touch screen.

➡ A Message Is Displayed

## ➤➤ Note

- You can also check the ink status on the computer screen.
  - ➡ Checking the Ink Status from Your Computer

## Maintenance

- ➔ [When Printing Becomes Faint or Colors Are Incorrect](#)
- ➔ [Performing Maintenance from a Computer](#)
- ➔ [Cleaning the Machine](#)

## When Printing Becomes Faint or Colors Are Incorrect

- Maintenance Procedure
- Printing the Nozzle Check Pattern
- Examining the Nozzle Check Pattern
- Cleaning the Print Head
- Cleaning the Print Head Deeply
- Aligning the Print Head
- Aligning the Print Head Manually



# Maintenance Procedure

If print results are blurred or colors are not printed correctly, the print head nozzle is probably clogged. Follow the procedure below to print the nozzle check pattern, check the print head nozzle condition, then clean the print head.

If printed ruled lines are misaligned or print results are otherwise unsatisfactory, aligning the print head may improve print quality.

## ►► Important

- Do not rinse or wipe the print head and ink tank. This can cause trouble with the print head and ink tank.

## ►► Note

### Before performing maintenance

- Make sure that the orange protective tape does not remain on the ink tank.

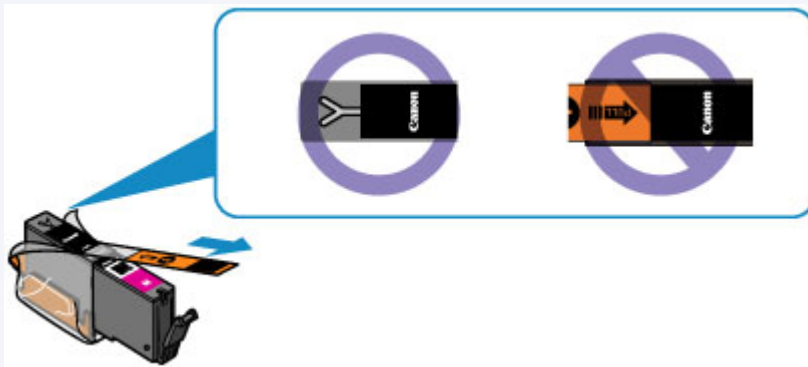

- Open the operation panel and make sure that the lamp on the ink tank is lit red. If the lamp is flashing or off, take appropriate action.
  - ➔ [Checking the Ink Status with the Ink Lamps](#)
- Increasing the print quality in the printer driver settings may improve the print result.
  - ➔ [Changing the Print Quality and Correcting Image Data](#)

## When the Print Results Are Blurred or Uneven:

### Step 1

#### Print the nozzle check pattern.

From the machine

➔ [Printing the Nozzle Check Pattern](#)

From the computer

➔ [Use Your Computer to Print a Nozzle Check Pattern](#)

#### Examine the nozzle check pattern.

➔ [Examining the Nozzle Check Pattern](#)

If there are missing lines or horizontal white streaks in the pattern:



### Step 2

#### Clean the print head.

From the machine

➔ [Cleaning the Print Head](#)

From the computer

➔ [Cleaning the Print Heads from Your Computer](#)

If the problem is not resolved after cleaning the print head twice:



### Step 3

#### Clean the print head deeply.

From the machine

➔ [Cleaning the Print Head Deeply](#)

From the computer

➔ [Cleaning the Print Heads from Your Computer](#)



After cleaning the print head, print and examine the nozzle check pattern.

#### »» Note

- When you have performed the procedure until step 3 and the problem has not been resolved, turn off the power and clean the print head deeply again after 24 hours. If the problem is still not resolved, the print head may be damaged. Contact the service center.

## When the Print Results Are Not Even such as the Ruled Lines Are Misaligned:

### Align the print head.

From the machine

➔ [Aligning the Print Head](#)

From the computer

➔ [Aligning the Print Head Position from Your Computer](#)

# Printing the Nozzle Check Pattern

Print the nozzle check pattern to determine whether the ink ejects properly from the print head nozzle.

➔ Watch the movie

## ➤➤➤ Note

- If the remaining ink level is low, the nozzle check pattern will not be printed correctly. Replace the ink tank whose ink is low.  
➔ [Replacing an Ink Tank](#)

## You need to prepare: a sheet of A4 or Letter-sized plain paper

1. Make sure that the power is turned on.
2. Make sure that one or more sheets of A4 or Letter-sized plain paper are loaded in the cassette (lower).
3. Open the paper output tray.
  - (1) Holding both sides of the paper output tray, gently open it.  
The output tray extension will open automatically when the paper output tray is opened.
  - (2) Extend the paper output support.

## ➤➤➤ Important

- If the inner cover is open, close it.

4. Print the nozzle check pattern.

- (1) Flick the HOME screen, then tap  **Setup**.  
➔ [Using the Operation Panel](#)

The setup menu screen will appear.

- (2) Tap  **Maintenance**.

The **Maintenance** screen will appear.

- (3) Tap **Print nozzle check pattern**.

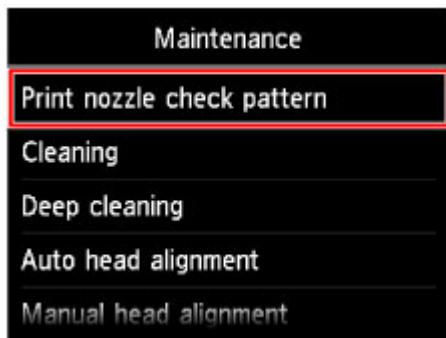

The confirmation screen will appear.

**(4) Tap Yes.**

The nozzle check pattern will be printed and two pattern confirmation screens will appear on the touch screen.

**5. Examine the nozzle check pattern.**

➡ [Examining the Nozzle Check Pattern](#)

# Examining the Nozzle Check Pattern

Examine the nozzle check pattern, and clean the print head if necessary.

1. Check if there are missing lines in the pattern **(C)** or horizontal white streaks in the pattern **(D)**.

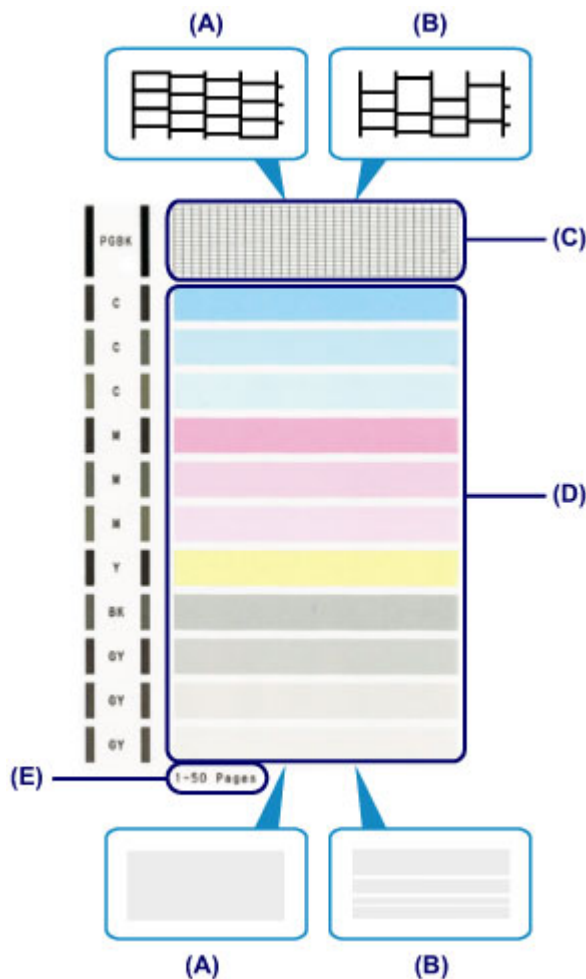

- (A)** No missing lines/No horizontal white streaks
- (B)** Lines are missing/Horizontal white streaks are present
- (E)** Number of sheets printed so far

2. Select the pattern that is closer to the printed nozzle check pattern on the confirmation screen.

Which is closer for printed color patterns?

A

B

All A

Also B

Which is closer for printed color patterns?

A

B

All A

Also B

For (A) (no missing lines or no horizontal white streaks) in both the pattern (C) and pattern (D):

(1) The cleaning is not required. Tap **All A**.

(2) Confirm the message, then tap **OK**.

The screen will return to the **Maintenance** screen.

### ▶▶▶ Note

- Touch the **HOME** button to exit **Setup** and display the HOME screen.

For (B) (lines are missing or horizontal white streaks are present) in the pattern (C) or pattern (D), or in both patterns:

(1) The cleaning is required. Tap **Also B**.

The cleaning confirmation screen will appear.

(2) Tap **Yes**.

The machine starts cleaning the print head.

➔ [Cleaning the Print Head](#)

### ▶▶▶ Note

- The total number of sheets printed so far is shown in increments of 50 sheets on the printout of the nozzle check pattern.

# Cleaning the Print Head

Clean the print head if lines are missing or if horizontal white streaks are present in the printed nozzle check pattern. Cleaning unclogs the nozzles and restores the print head condition. Cleaning the print head consumes ink, so clean the print head only when necessary.

## You need to prepare: a sheet of A4 or Letter-sized plain paper

1. Make sure that the power is turned on.
2. Make sure that one or more sheets of A4 or Letter-sized plain paper are loaded in the cassette (lower).
3. Open the paper output tray.
  - (1) Holding both sides of the paper output tray, gently open it.  
The output tray extension will open automatically when the paper output tray is opened.
  - (2) Extend the paper output support.

### ►► Important

- If the inner cover is open, close it.

4. Clean the print head.

- (1) Flick the HOME screen, then tap  **Setup**.

➔ [Using the Operation Panel](#)

The setup menu screen will appear.

- (2) Tap  **Maintenance**.

The **Maintenance** screen will appear.

- (3) Tap **Cleaning**.



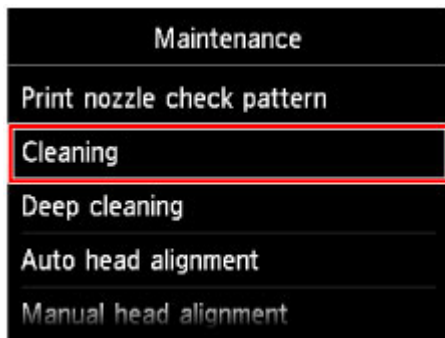

The confirmation screen will appear.

**(4) Tap Yes.**

The machine starts cleaning the print head.

Do not perform any other operations until the machine completes the cleaning of the print head. This takes about 2 to 3 minutes.

The pattern print confirmation screen will appear.

**(5) Tap Yes.**

The nozzle check pattern will be printed.

**5. Examine the nozzle check pattern.**

➔ [Examining the Nozzle Check Pattern](#)

**»» Note**

- Touch the **HOME** button to exit **Setup** and display the HOME screen.
- If the problem is not resolved after cleaning the print head twice, clean the print head deeply.

➔ [Cleaning the Print Head Deeply](#)

# Cleaning the Print Head Deeply

If print quality does not improve by the standard cleaning of the print head, clean the print head deeply. Cleaning the print head deeply consumes more ink than the standard cleaning of the print head, so clean the print head deeply only when necessary.

## You need to prepare: a sheet of A4 or Letter-sized plain paper

1. Make sure that the power is turned on.
2. Make sure that one or more sheets of A4 or Letter-sized plain paper are loaded in the cassette (lower).
3. Open the paper output tray.
  - (1) Holding both sides of the paper output tray, gently open it.  
The output tray extension will open automatically when the paper output tray is opened.
  - (2) Extend the paper output support.

### ▶▶▶ Important

- If the inner cover is open, close it.

4. Clean the print head deeply.

- (1) Flick the HOME screen, then tap  **Setup**.

➔ [Using the Operation Panel](#)

The setup menu screen will appear.

- (2) Tap  **Maintenance**.

The **Maintenance** screen will appear.

- (3) Tap **Deep cleaning**.

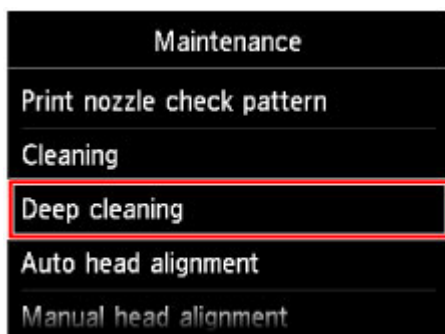

The confirmation screen will appear.

**(4) Tap Yes.**

The machine starts cleaning the print head deeply.

Do not perform any other operations until the machine completes the deep cleaning of the print head. This takes about 2 to 3 minutes.

The pattern print confirmation screen will appear.

**(5) Tap Yes.**

The nozzle check pattern will be printed.

**(6) When the completion message appears, tap OK.**

The screen will return to the **Maintenance** screen.

**5. Examine the nozzle check pattern.**

➔ [Examining the Nozzle Check Pattern](#)

If a particular color is not printed properly, replace the ink tank of that color.

➔ [Replacing an Ink Tank](#)

If the problem is not resolved, turn off the power and clean the print head deeply again after 24 hours.

If the problem is still not resolved, the print head may be damaged. Contact the service center.

**▶▶▶ Note**

- Touch the **HOME** button to exit **Setup** and display the HOME screen.

# Aligning the Print Head

If printed ruled lines are misaligned or print results are otherwise unsatisfactory, adjust the print head position.

## »» Note

- If the remaining ink level is low, the print head alignment sheet will not be printed correctly. Replace the ink tank whose ink is low.
  - ➔ [Replacing an Ink Tank](#)
- If you run out of the supplied paper (Matte Photo Paper MP-101) or the specified Canon genuine paper is not immediately available or obtainable, you can use plain paper and align the print head manually.
  - From the machine
    - ➔ [Aligning the Print Head Manually](#)
  - From the computer
    - ➔ [Aligning the Print Head Position Manually from Your Computer](#)
- The print head alignment pattern is printed in black and blue.

## You need to prepare: a sheet of A4 or Letter-sized Matte Photo Paper MP-101

1. Make sure that the power is turned on.
2. Load a sheet of supplied paper or A4 or Letter-sized Matte Photo Paper MP-101 in the cassette (lower).

Load the paper WITH THE PRINT SIDE (WHITER SIDE) FACING DOWN in the cassette (lower).

## »» Important

- The cassette (upper) is not available for the print head alignment procedure. Be sure to load paper in the cassette (lower).

3. Open the paper output tray.
  - (1) Holding both sides of the paper output tray, gently open it.

The output tray extension will open automatically when the paper output tray is opened.
  - (2) Extend the paper output support.

## »» Important

- If the inner cover is open, close it.

### 4. Adjust the print head position automatically.

(1) Flick the HOME screen, then tap  **Setup**.

➔ [Using the Operation Panel](#)

The setup menu screen will appear.

(2) Tap  **Maintenance**.

The **Maintenance** screen will appear.

(3) Tap **Auto head alignment**.

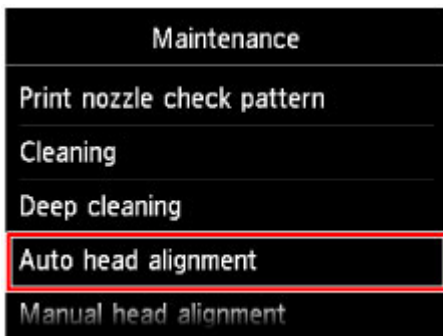

The confirmation screen will appear.

(4) Tap **Yes**.

The print head alignment sheet will be printed and the print head position will be adjusted automatically.

This takes about 3 to 4 minutes.

## »» Important

- Do not open the operation panel while printing is in progress.

## »» Note

- If the automatic adjustment of the print head position has failed, the error message appears on the touch screen.

➔ A Message Is Displayed

(5) When the completion message appears, tap **OK**.

The screen will return to the **Maintenance** screen.

## »» Note

- Touch the **HOME** button to exit **Setup** and display the HOME screen.

- If the print results are still not satisfactory after adjusting the print head position as described above, adjust the print head position manually.

From the machine

➔ [Aligning the Print Head Manually](#)

From the computer

➔ [Aligning the Print Head Position Manually from Your Computer](#)

---

# Aligning the Print Head Manually

If printed ruled lines are misaligned or print results are still not satisfactory after adjusting the print head position automatically, adjust the print head position manually.

## »» Note

- For details on adjusting the print head position automatically, see [Aligning the Print Head](#).
- The print head alignment pattern is printed in black and blue.

## You need to prepare: three sheets of A4 or Letter-sized plain paper

1. Make sure that the power is turned on.
2. Make sure that three or more sheets of A4 or Letter-sized plain paper are loaded in the cassette (lower).

3. Open the paper output tray.

(1) Holding both sides of the paper output tray, gently open it.

The output tray extension will open automatically when the paper output tray is opened.

(2) Extend the paper output support.

## »» Important

- If the inner cover is open, close it.

4. Print the print head alignment pattern.

(1) Flick the HOME screen, then tap  **Setup**.

➔ [Using the Operation Panel](#)

The setup menu screen will appear.

(2) Tap  **Maintenance**.

The **Maintenance** screen will appear.

(3) Tap **Manual head alignment**.

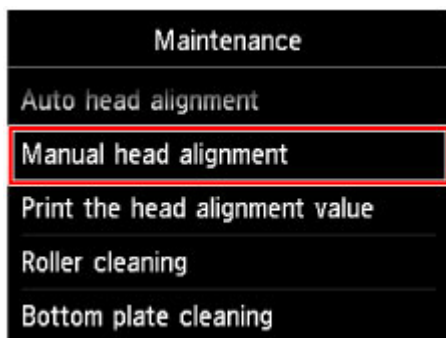

The confirmation screen will appear.

### ➤➤ Note

- To print and check the current head position adjustment values, select **Print the head alignment value**.

#### (4) Tap **Yes**.

The print head alignment pattern is printed.

### ➤➤ Important

- Do not open the operation panel while printing is in progress.

#### (5) When the message "**Did the patterns print correctly?**" appears, confirm that the pattern is printed correctly, tap **Yes**.

#### (6) Confirm the message, then tap **Next**.

The input screen for the head position adjustment values will appear.

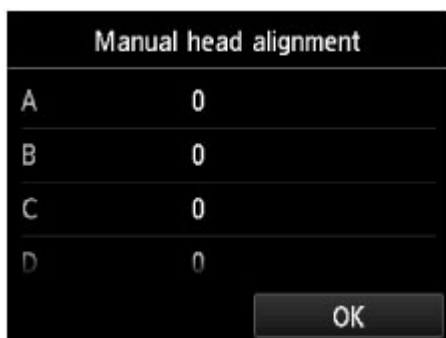

#### 5. Look at the first pattern and adjust the print head position.

##### (1) Tap A to check the printed patterns, and tap the number of the pattern in column A that has the least noticeable vertical streaks.



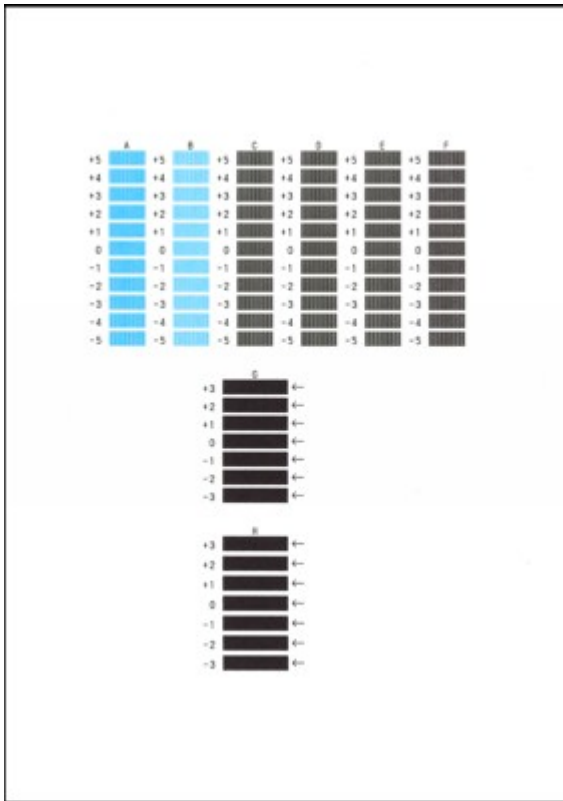

➤➤➤ **Note**

- If it is difficult to pick the best pattern, pick the setting that produces the least noticeable vertical streaks.

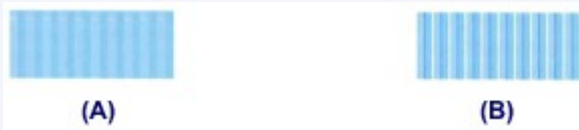

- (A) Least noticeable vertical streaks
- (B) Most noticeable vertical streaks

(2) Repeat the same procedure until you finish inputting the pattern number for columns B to H, then tap **OK**.

For columns G and H, pick the setting that produces the least noticeable horizontal streaks at the position indicated by an arrow.

➤➤➤ **Note**

- If it is difficult to pick the best pattern, pick the setting that produces the least noticeable horizontal streaks.

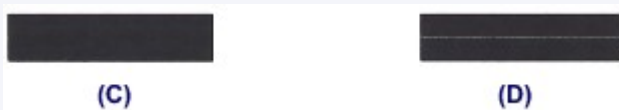

- (C) Least noticeable horizontal streaks
- (D) Most noticeable horizontal streaks

(3) Confirm the message, then tap **OK**.

The second pattern is printed.

»» **Important**

- Do not open the operation panel while printing is in progress.

6. Look at the second pattern and adjust the print head position.

(1) Tap I to check the printed patterns, and tap the number of the pattern in column I that has the least noticeable vertical streaks.

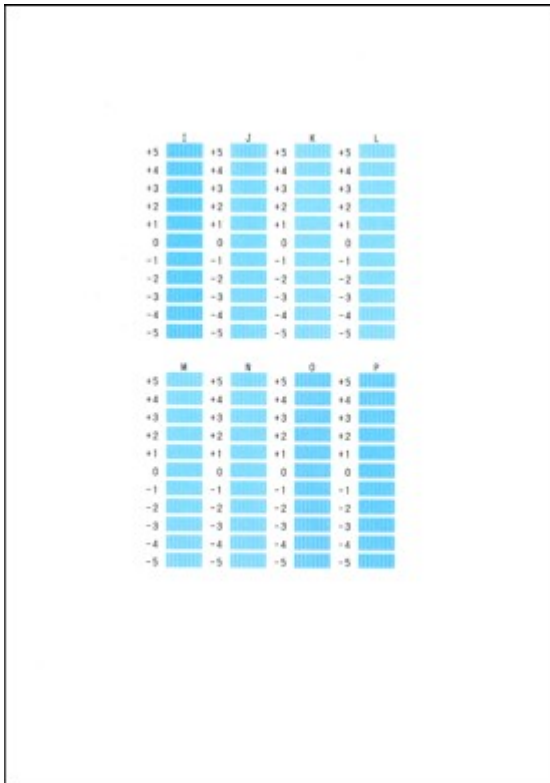

»» **Note**

- If it is difficult to pick the best pattern, pick the setting that produces the least noticeable vertical streaks.



(E) Least noticeable vertical streaks

(F) Most noticeable vertical streaks

(2) Repeat the same procedure until you finish inputting the pattern number for columns J to P, then tap **OK**.

(3) Confirm the message, then tap **OK**.

The third pattern is printed.

## ►► Important

- Do not open the operation panel while printing is in progress.

7. Look at the third pattern and adjust the print head position.

(1) Tap a to check the printed patterns, and tap the number of the pattern in column a that has the least noticeable horizontal stripes.

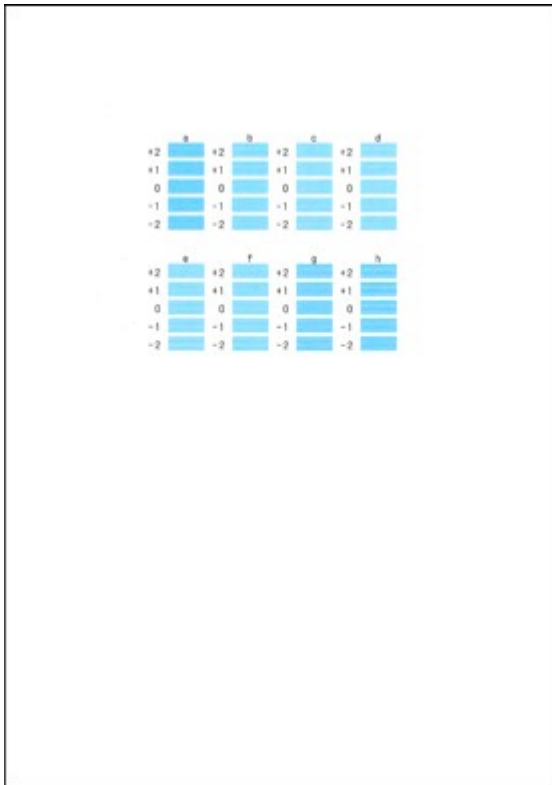

## ►► Note

- If it is difficult to pick the best pattern, pick the setting that produces the least noticeable horizontal stripes.

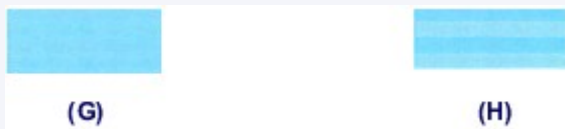

(G) Least noticeable horizontal stripes

(H) Most noticeable horizontal stripes

(2) Repeat the same procedure until you finish inputting the pattern number for columns b to h, then tap **OK**.

The manual adjustment of the print head position is complete.

(3) When the completion message appears, tap **OK**.

The screen will return to the **Maintenance** screen.

## »» Note

- Touch the **HOME** button to exit **Setup** and display the HOME screen.

# Performing Maintenance from a Computer

- [Cleaning the Print Heads from Your Computer](#)
- [Cleaning the Paper Feed Rollers from Your Computer](#)
- [Aligning the Print Head Position from Your Computer](#)
- [Use Your Computer to Print a Nozzle Check Pattern](#)
- [Cleaning Inside the Machine](#)

# Cleaning the Print Heads from Your Computer

The print head cleaning function allows you to clear up clogged print head nozzle. Perform print head cleaning if printing is faint or a specific color fails to print, even though there is enough ink.

The procedure for cleaning the print head is as follows:



## Cleaning

### 1. Open the printer driver setup window

### 2. Click **Cleaning** on the **Maintenance** tab

When the **Print Head Cleaning** dialog box opens, select the ink group for which cleaning is to be performed.

Click **Initial Check Items** to display the items you need to check before performing cleaning.

### 3. Execute cleaning

Make sure that the machine is on and then click **Execute**.

Print head cleaning starts.

#### »» Important

- Do not close the paper output tray until the cleaning is complete.

### 4. Complete cleaning

The **Nozzle Check** dialog box opens after the confirmation message.

### 5. Check the results

To check whether the print quality has improved, click **Print Check Pattern**. To cancel the check process, click **Cancel**.

If cleaning the head once does not resolve the print head problem, clean it once more.

#### »» Important

- **Cleaning** consumes a small amount of ink.  
Cleaning the print head frequently will rapidly deplete your printer's ink supply.  
Consequently, perform cleaning only when necessary.



## Deep Cleaning

**Deep Cleaning** is more thorough than cleaning. Perform deep cleaning when two **Cleaning** attempts do not resolve the print head problem.

### 1. Open the printer driver setup window

### 2. Click **Deep Cleaning** on the **Maintenance** tab

When the **Deep Cleaning** dialog box opens, select the ink group for which deep cleaning is to be performed.

Click **Initial Check Items** to display the items you need to check before performing deep cleaning.

### 3. Execute deep cleaning

Make sure that the machine is on and then click **Execute**.

Click **OK** when the confirmation message appears.

Print head deep cleaning starts.

#### »» Important

- Do not close the paper output tray until the deep cleaning is complete.

### 4. Complete deep cleaning

The **Nozzle Check** dialog box opens after the confirmation message.

### 5. Check the results

To check whether the print quality has improved, click **Print Check Pattern**. To cancel the check process, click **Cancel**.

#### »» Important

- **Deep Cleaning** consumes a larger amount of ink than **Cleaning**.  
Cleaning the print head frequently will rapidly deplete your printer's ink supply.  
Consequently, perform cleaning only when necessary.

#### »» Note

- If there is no sign of improvement after **Deep Cleaning**, switch off the machine, wait 24 hours, and then perform **Deep Cleaning** again. If there is still no sign of improvement, the ink may have run out or the print head may be worn. For details on the remedial action to be taken, see "Ink Is Not Ejected."

## Related Topic

- [Use Your Computer to Print a Nozzle Check Pattern](#)



# Cleaning the Paper Feed Rollers from Your Computer

Cleans the paper feed rollers. Perform feed roller cleaning when there are paper particles sticking to the paper feed rollers and paper is not fed properly.

The procedure for performing the feed roller cleaning is as follows:



## Roller Cleaning

### 1. Prepare the machine

Remove all sheets of paper from the paper source from which paper could not be properly fed.

### 2. Open the printer driver setup window

### 3. Click **Roller Cleaning** on the **Maintenance** tab

The **Roller Cleaning** dialog box opens.

### 4. Select **Cassette (upper)** or **Cassette (lower)**, and then click **OK**

The confirmation message appears.

### 5. Execute paper feed roller cleaning

Make sure that the machine is on and then click **OK**.

Paper feed roller cleaning starts.

### 6. Complete paper feed roller cleaning

- **Cleaning the feeding rollers of the cassette (upper)**

Cut a sheet of A4 size or Letter size plain paper into four pieces by cutting it in half vertically and then in half horizontally.

After the rollers have stopped, follow the message instructions and load one sheet of plain paper or a commercially available cleaning sheet into the front tray. Then click **OK**.

- **Cleaning the feeding rollers of the cassette (lower)**

After the rollers have stopped, follow the instruction in the message, load three sheets of A4 size or Letter size plain paper into the cassette (lower), and click **OK**.

Paper will be ejected and feed roller cleaning will be completed.

# Aligning the Print Head Position from Your Computer

Print head alignment corrects the installation positions of the print head and improves deviated colors and lines.

This machine supports two head alignment methods: automatic head alignment and manual head alignment. Normally, the machine is set for automatic head alignment.

If the printing results of automatic print head alignment are not satisfactory, [perform manual head alignment](#).

The procedure for performing automatic print head alignment is as follows:

## »» Note

- If the inner cover is open, close it.
- The pattern is printed only in black and blue.



## Print Head Alignment

1. Open the printer driver setup window
2. Click **Print Head Alignment** on the **Maintenance** tab

The **Start Print Head Alignment** dialog box opens.

3. Load paper in the machine

Load one sheet of A4 size or Letter size Matte Photo Paper (MP-101) into the cassette (lower).

## »» Note

- The type of media and number of sheets to be used differ when you select the manual head alignment.

4. Execute head alignment

Make sure that the machine is on and click **Align Print Head**.

Follow the instruction in the message.

## »» Important

- Do not open the operation panel while printing is in progress.

## ▶▶ Note

---

- Wait until printing ends before performing other operations. Printing takes about 4 minutes to complete.
  - To print and check the current setting, open the **Start Print Head Alignment** dialog box, and click **Print Alignment Value**.
-

# Aligning the Print Head Position Manually from Your Computer

Print head alignment corrects the installation positions of the print head and improves deviated colors and lines.

This machine supports two head alignment methods: [automatic head alignment](#) and manual head alignment. Normally, the machine is set for automatic head alignment.

If the printing results of automatic print head alignment are not satisfactory, perform manual head alignment.

The procedure for performing manual print head alignment is as follows:

## »» Note

- If the inner cover is open, close it.
- The pattern is printed only in black and blue.

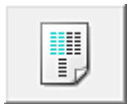

## Print Head Alignment

1. Open the printer driver setup window
2. Click **Custom Settings** on the **Maintenance** tab

The **Custom Settings** dialog box opens.

## »» Note

- If the machine is off or if communication between the machine and the computer is disabled, an error message may appear because the computer cannot collect the machine status.

If this happens, click **OK** to display the most recent settings specified on your computer.

3. Switch head alignment to manual  
Check the **Align heads manually** check box.
4. Apply the settings  
Click **OK** and when the confirmation message appears, click **OK**.
5. Click **Print Head Alignment** on the **Maintenance** tab

The **Start Print Head Alignment** dialog box opens.

## 6. Load paper in the machine

Load three sheets of A4 size or Letter size plain paper into the cassette (lower).

## 7. Execute head alignment

Make sure that the machine is on and click **Align Print Head**.

Follow the instruction in the message.

### »» Important

- Do not open the operation panel while printing is in progress.

## 8. Check the printed pattern

Enter the numbers of the patterns with the least amount of streaks in the associated boxes.

Even if the patterns with the least amount of streaks are clicked in the preview window, their numbers are automatically entered in the associated boxes.

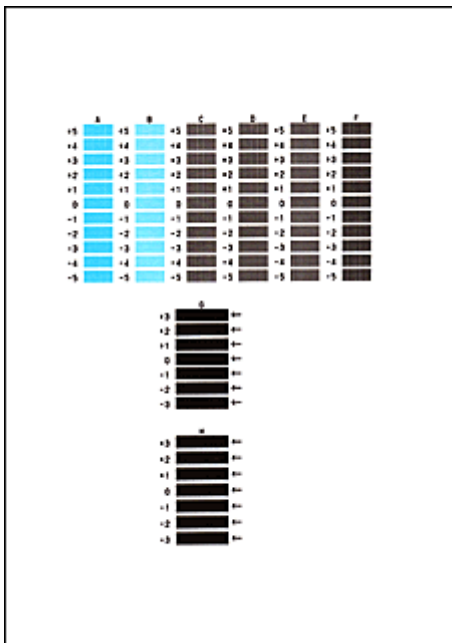

When you have entered all the necessary values, click **OK**.

### »» Note

- If it is difficult to pick the best pattern, pick the setting that produces the least noticeable vertical streaks.



(A)



(B)

(A) Least noticeable vertical streaks

(B) Most noticeable vertical streaks

- If it is difficult to pick the best pattern, pick the setting that produces the least noticeable horizontal streaks.



(A)



(B)

- (A) Least noticeable horizontal streaks  
 (B) Most noticeable horizontal streaks

## 9. Confirm the displayed message and click **OK**

The second pattern is printed.

### »» Important

- Do not open the operation panel while printing is in progress.

## 10. Check the printed pattern

Enter the numbers of the patterns with the least noticeable horizontal stripes in the associated boxes.

Even if the patterns with the least noticeable horizontal stripes are clicked in the preview window, their numbers are automatically entered in the associated boxes.

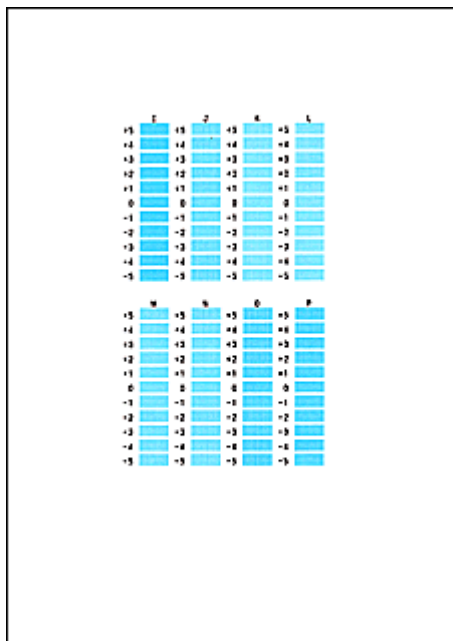

When you have entered all the necessary values, click **OK**.

### »» Note

- If it is difficult to pick the best pattern, pick the setting that produces the least noticeable vertical streaks.



(A)



(B)

- (A) Least noticeable vertical streaks
- (B) Most noticeable vertical streaks

**11. Confirm the displayed message and click **OK****

The third pattern is printed.

**»» Important**

- Do not open the operation panel while printing is in progress.

**12. Check the printed pattern**

Enter the numbers of the patterns with the least noticeable horizontal stripes in the associated boxes.

Even if the patterns with the least noticeable horizontal stripes are clicked in the preview window, their numbers are automatically entered in the associated boxes.

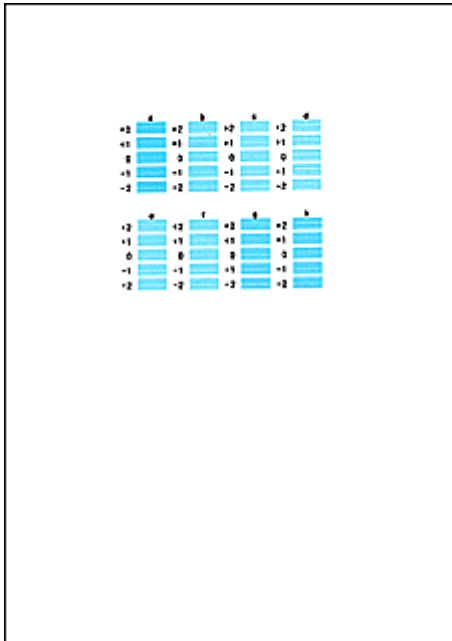

When you have entered all the necessary values, click **OK**.

**»» Note**

- If it is difficult to pick the best pattern, pick the setting that produces the least noticeable horizontal stripes.



(A)



(B)

- (A) Least noticeable horizontal stripes
- (B) Most noticeable horizontal stripes

## »» Note

- To print and check the current setting, open the **Start Print Head Alignment** dialog box, and click **Print Alignment Value**.



# Use Your Computer to Print a Nozzle Check Pattern

The nozzle check function allows you to check whether the print head is working properly by printing a nozzle check pattern. Print the pattern if printing becomes faint, or if a specific color fails to print.

The procedure for printing a nozzle check pattern is as follows:



## Nozzle Check

1. Open the printer driver setup window

2. Click **Nozzle Check** on the **Maintenance** tab

The **Nozzle Check** dialog box opens.

Click **Initial Check Items** to display the items that you need to check before printing the nozzle check pattern.

3. Load paper in the machine

Load one sheet of A4 size or Letter size plain paper into the cassette (lower).

4. Print a nozzle check pattern

Make sure that the machine is on and click **Print Check Pattern**.

Printing of the nozzle check pattern begins.

Click **OK** when the confirmation message appears.

The **Pattern Check** dialog box opens.

5. Check the print result

Check the print result. When the print result is normal, click **Exit**.

If the print result is smudged or if there are any unprinted sections, click **Cleaning** to clean the print head.

## Related Topic

- [Cleaning the Print Heads from Your Computer](#)

# Cleaning Inside the Machine

Perform bottom plate cleaning before you execute duplex printing to prevent smudges on the back side of the paper.

Also perform bottom plate cleaning if ink smudges caused by something other than print data appear on the printed page.

The procedure for performing bottom plate cleaning is as follows:



## Bottom Plate Cleaning

1. Open the printer driver setup window
2. Click **Bottom Plate Cleaning** on the **Maintenance** tab

The **Bottom Plate Cleaning** dialog box opens.

3. **Load paper** in the machine

As instructed in the dialog box, fold the A4 size or Letter size plain paper in half horizontally, and then unfold the sheet.

Fold one side of the paper in another half, aligning the edge with the center crease, then unfold the paper.

With the ridges of the creases facing up, load the paper into the cassette (lower), so that the edge of the half with no crease faces away from you.

4. Perform the bottom plate cleaning

Make sure that the machine is on and then click **Execute**.

Bottom plate cleaning starts.

# Cleaning the Machine

- Cleaning the Exterior of the Machine
- Cleaning the Platen Glass and Document Cover
- Cleaning the Paper Feed Roller
- Cleaning the Inside of the Machine (Bottom Plate Cleaning)
- Cleaning the Protrusions inside the Machine
- Cleaning the Pad in the Cassette

## Cleaning the Exterior of the Machine

Be sure to use a soft and dry cloth such as eyeglasses cleaning cloth and wipe off dirt on the surface gently. Smooth out wrinkles on the cloth if necessary before cleaning.

### »» Important

- Be sure to turn off the power and disconnect the power plug before cleaning the machine.
- Do not use tissue paper, paper towels, rough-textured cloth, or similar materials for cleaning so as not to scratch the surface. Paper tissue powder or fine threads may remain inside the machine and cause problems such as print head blockage and poor printing results. Be sure to use a soft and dry cloth.
- Never use volatile liquids such as thinners, benzene, acetone, or any other chemical cleaner to clean the machine, as this may cause a malfunction or damage the surface of the machine.
- Use a soft cloth soaked in water and wrung well to wipe off stains on the operation panel. Do not turn on the power until the surface of the operation panel has completely dried.

# Cleaning the Platen Glass and Document Cover

## »» Important

- Be sure to turn off the power and disconnect the power plug before cleaning the machine.
- Do not use tissue paper, paper towels, rough-textured cloth, or similar materials for cleaning so as not to scratch the surface. Paper tissue powder or fine threads may remain inside the machine and cause problems such as print head blockage and poor printing results. Be sure to use a soft and dry cloth.
- Never use volatile liquids such as thinners, benzene, acetone, or any other chemical cleaner to clean the machine, as this may cause a malfunction or damage the surface of the machine.

With a soft, clean, lint-free and dry cloth, wipe the platen glass **(A)** and the inner side of the document cover (white sheet) **(B)** gently. Make sure not to leave any residue, especially on the glass surface.

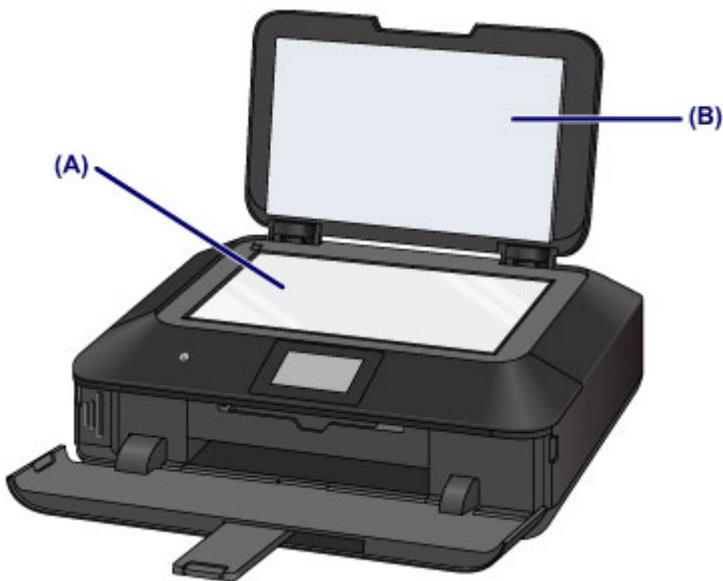

## »» Important

- The inner side of the document cover (white sheet) **(B)** is easily damaged, so wipe it gently.

# Cleaning the Paper Feed Roller

If the paper feed roller is dirty or paper powder is attached to it, paper may not be fed properly.

In this case, clean the paper feed roller. Cleaning will wear out the paper feed roller, so perform this only when necessary.

## You need to prepare

**For the cassette (upper): A single sheet of A4 or Letter-sized plain paper (to be cut for use)**

**For the cassette (lower): Three sheets of A4 or Letter-sized plain paper**

1. Make sure that the power is turned on.
2. Select **Roller cleaning**.

(1) Flick the HOME screen, then tap  **Setup**.  
➔ [Using the Operation Panel](#)

The setup menu screen will appear.

(2) Tap  **Maintenance**.

The **Maintenance** screen will appear.

(3) Tap **Roller cleaning**.

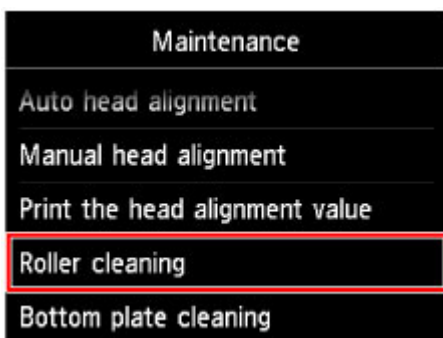

The confirmation screen will appear.

(4) Tap **Yes**.

(5) Tap the paper source to clean (**Cassette (upper)** or **Cassette (lower)**).

3. Clean the paper feed roller without paper.

(1) Follow the message to remove any paper from the paper source you selected in (5) of step 2.

(2) Tap **OK**.

The paper feed roller will rotate as it is cleaned.

4. Clean the paper feed roller with paper.

(1) Make sure that the paper feed roller has stopped rotating, then follow the message to load plain paper as follows in the paper source you selected in (5) of step 2.

**Loading paper in the cassette (upper):**

Cut a single sheet of A4 or Letter-sized plain paper into four pieces.

Load them in the cassette (upper) with the top and bottom edges **(A)** towards the back side of the cassette (upper).

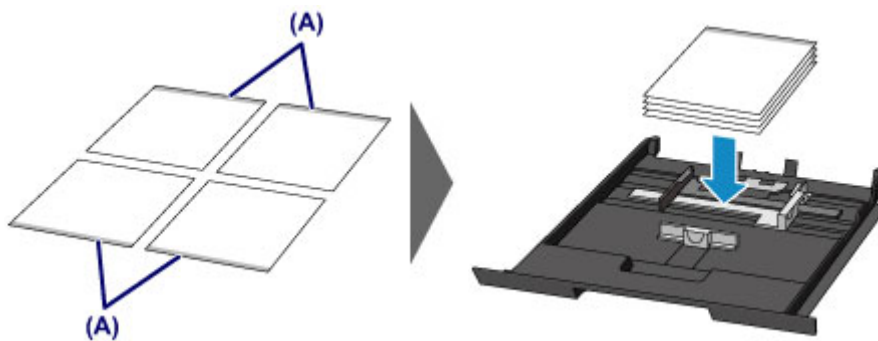

**Loading paper in the cassette (lower):**

Load three sheets of A4 or Letter-sized paper in the cassette (lower).

(2) Holding both sides of the paper output tray, gently open it.

The output tray extension will open automatically when the paper output tray is opened.

(3) Extend the paper output support.

**»» Important**

- If the inner cover is open, close it.

(4) Tap **OK**.

The machine starts cleaning. The cleaning will be complete when the paper is ejected.

(5) When the completion message appears, tap **OK**.

The screen will return to the **Maintenance** screen.

## »» Note

- Touch the **HOME** button to exit **Setup** and display the HOME screen.

If the problem is not resolved after cleaning the paper feed roller, contact the service center.



## Cleaning the Inside of the Machine (Bottom Plate Cleaning)

Remove stains from the inside of the machine. If the inside of the machine becomes dirty, printed paper may get dirty, so we recommend performing cleaning regularly.

**You need to prepare: a sheet of A4 or Letter-sized plain paper\***

\* Be sure to use a new piece of paper.

1. Make sure that the power is turned on.
2. Clean the inside of the machine.

(1) Flick the HOME screen, then tap  **Setup**.

➔ [Using the Operation Panel](#)

The setup menu screen will appear.

(2) Tap  **Maintenance**.

The **Maintenance** screen will appear.

(3) Tap **Bottom plate cleaning**.

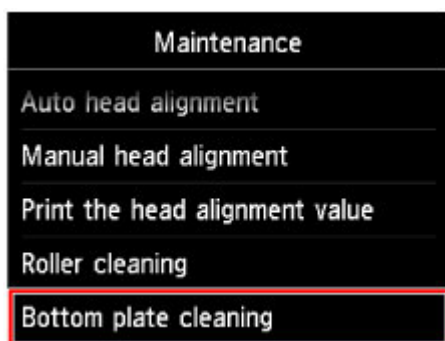

The confirmation screen will appear.

- (4) Tap **Yes**.
- (5) Follow the message to remove any paper from the cassette (lower), then tap **OK**.
- (6) Fold a single sheet of A4 or Letter-sized plain paper in half widthwise, then unfold the paper.
- (7) Fold one side of the opened paper in another half, aligning the edge with the center crease, unfold the paper, then tap **OK**.

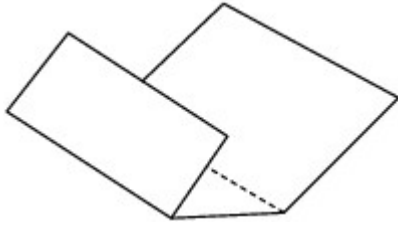

- (8) Load only this sheet of paper in the cassette (lower) with the ridges of the creases facing up and the edge of the half with no crease facing to the far side.



- (9) Holding both sides of the paper output tray, gently open it.  
The output tray extension will open automatically when the paper output tray is opened.

- (10) Extend the paper output support.

»» Important

- If the inner cover is open, close it.

- (11) Tap **OK**.

The paper cleans the inside of the machine as it feeds through the machine.

Check the folded parts of the ejected paper. If they are smudged with ink, perform Bottom Plate Cleaning again.

- (12) When the completion message appears, tap **OK**.

The screen will return to the **Maintenance** screen.

If the problem is not resolved after performing cleaning again, the protrusions inside the machine may be stained. Clean them according to instructions.

➔ [Cleaning the Protrusions inside the Machine](#)

»» Note

- Touch the **HOME** button to exit **Setup** and display the HOME screen.

- When performing Bottom Plate Cleaning again, be sure to use a new piece of paper.
-

# Cleaning the Protrusions inside the Machine

## »» Important

- Be sure to turn off the power and disconnect the power plug before cleaning the machine.

### You need to prepare: cotton swab

If the protrusions inside the machine are stained, wipe off any ink from the protrusions using a cotton swab or the like.



## Cleaning the Pad in the Cassette

If the pad in a cassette is smeared with paper powder or dirt, two or more sheets of paper may be ejected. Follow the procedure below to clean the pad in a cassette.

### You need to prepare: cotton swab

1. Pull out the cassette (upper) or cassette (lower) from the machine, then remove all the paper.
2. Clean the pad **(A)** sideways with a moistened cotton swab.

#### ►► Important

- After cleaning the smeared pad, dry it completely.

#### For the cassette (upper):

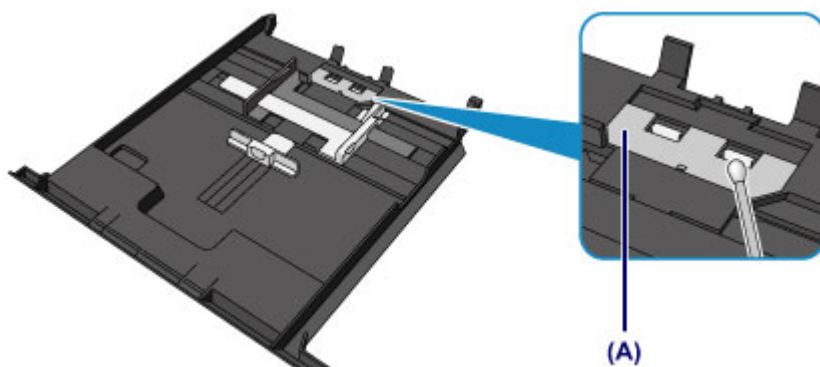

#### For the cassette (lower):

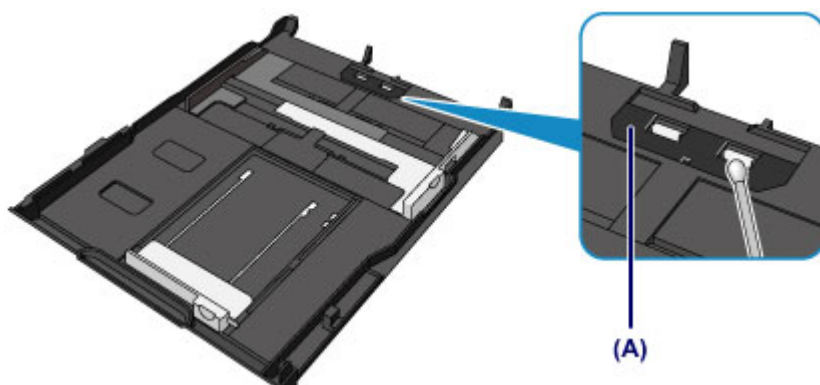

If the problem is not resolved, contact the service center.

## Changing the Machine Settings

- ➔ [Changing Machine Settings from Your Computer](#)
- ➔ [Changing the Machine Settings Using the Operation Panel](#)
- ➔ [Setting Up the Card Slot as the Memory Card Drive of the Computer](#)

## Changing Machine Settings from Your Computer

- ➔ [Changing the Print Options](#)
- ➔ [Registering a Frequently Used Printing Profile](#)
- ➔ [Managing the Machine Power](#)
- ➔ [Reducing the Machine Noise](#)
- ➔ [Changing the Machine Operation Mode](#)

# Changing the Print Options

You can change the detailed print driver settings for print data that is sent from an application software.

Specify this option if you encounter print failures such as part of an image data being cut off.

The procedure for changing the print options is as follows:

1. Open the printer driver setup window
2. Click **Print Options...** on the **Page Setup** tab

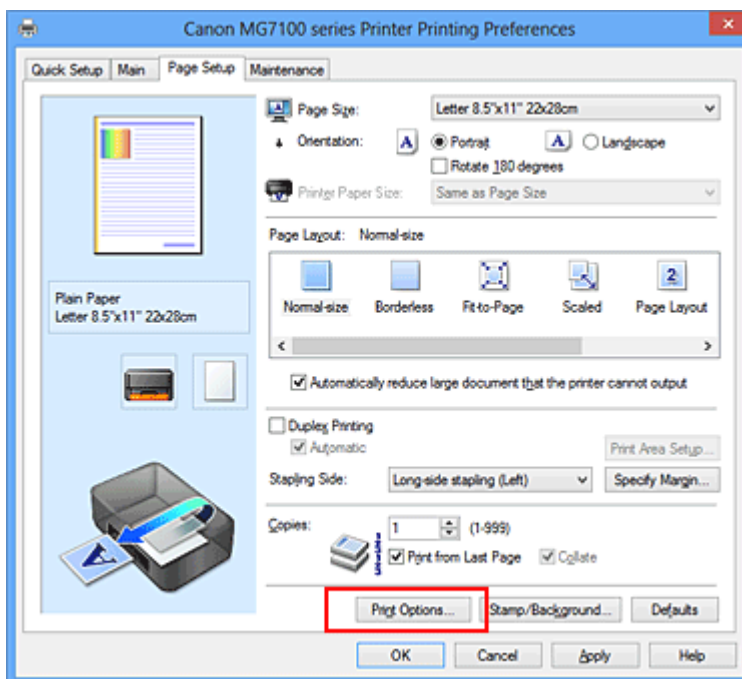

The **Print Options** dialog box opens.

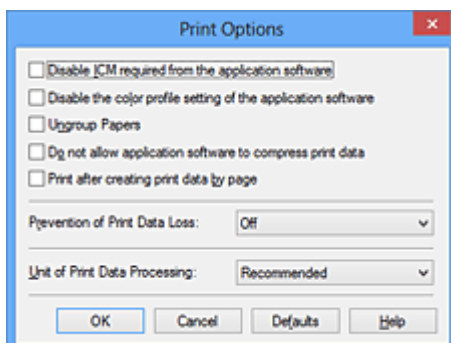

## ►►► Note

- When you use the XPS printer driver, the functions available to you are different.



### 3. Change the individual settings

If necessary, change the setting of each item, and then click **OK**.

The **Page Setup** tab is displayed again.

# Registering a Frequently Used Printing Profile

You can register the frequently used printing profile to **Commonly Used Settings** on the **Quick Setup** tab. Unnecessary printing profiles can be deleted at any time.

The procedure for registering a printing profile is as follows:

## Registering a Printing Profile

1. Open the printer driver setup window

2. Set the necessary items

From **Commonly Used Settings** on the **Quick Setup** tab, select the printing profile to be used and if necessary, change the settings after **Additional Features**.

You can also register necessary items on the **Main** and **Page Setup** tabs.

3. Click **Save...**

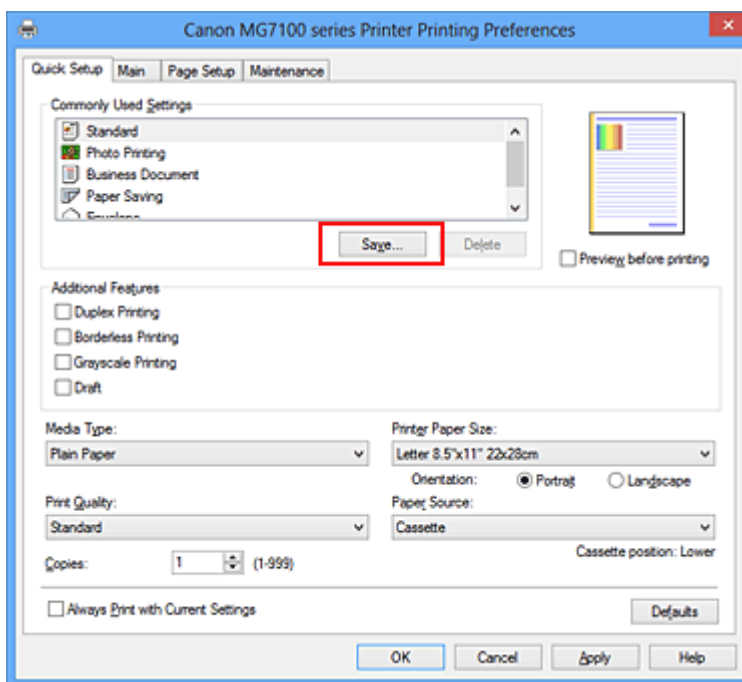

The **Save Commonly Used Settings** dialog box opens.



4. Save the settings

Enter a name in the **Name** field. If necessary, click **Options...**, set the items, and then click **OK**.

In the **Save Commonly Used Settings** dialog box, click **OK** to save the print settings and return to the **Quick Setup** tab.

The name and icon are displayed in **Commonly Used Settings**.

### »» Important

- To save the page size, orientation, and number of copies that was set in each sheet, click **Options...**, and check each item.

### »» Note

- When you install the printer driver again or upgrade the version of the printer driver, the print settings you registered will be deleted from **Commonly Used Settings**. Registered print settings cannot be saved and preserved. If a profile is deleted, register the print settings again.

## Deleting Unnecessary Printing Profile

### 1. Select the printing profile to be deleted

Select the printing profile you want to delete from the **Commonly Used Settings** list on the **Quick Setup** tab.

### 2. Delete the printing profile

Click **Delete**. When the confirmation message appears, click **OK**.

The selected printing profile is deleted from the **Commonly Used Settings** list.

### »» Note

- Printing profiles that are registered in the initial settings cannot be deleted.

## Managing the Machine Power

This function allows you to manage the machine power from the printer driver.

The procedure for managing the machine power is as follows:



### Power Off

The **Power Off** function turns off the machine. When you use this function, you will not be able to turn the machine on from the printer driver.

1. Open the printer driver setup window

2. Execute power off

Click **Power Off** on the **Maintenance** tab. When the confirmation message appears, click **OK**.

The machine power switches off, and the **Maintenance** tab is displayed again.



### Auto Power

**Auto Power** allows you to set **Auto Power On** and **Auto Power Off**.

The **Auto Power On** function automatically turns on the machine when data is received.

The **Auto Power Off** function automatically turns off the machine when there are no operations from the printer driver or the machine for a specified period of time.

1. Open the printer driver setup window

2. Make sure that the machine is on and then click **Auto Power** on the **Maintenance** tab

The **Auto Power Settings** dialog box opens.

#### »» Note

- If the machine is off or if communication between the machine and the computer is disabled, an error message may appear because the computer cannot collect the machine status.

If this happens, click **OK** to display the most recent settings specified on your computer.

### 3. If necessary, complete the following settings:

#### **Auto Power On**

Specifying **Enable** from the list will turn the machine on upon receipt of print data.

#### **Auto Power Off**

Specify the time from the list. When this time lapses without any operations from the printer driver or the machine, the machine is turned off automatically.

### 4. Apply the settings

Click **OK**. When the confirmation message appears, click **OK**.

The **Maintenance** tab is displayed again.

The auto power on/off function is enabled hereafter. When you want to disable this function, select **Disable** from the list according to the same procedure.

#### ▶▶▶ **Note**

- When the machine is turned off, the status monitor message varies depending on the **Auto Power On** setting.  
When the setting is **Enable**, "Printer is standing by" is displayed. When the setting is **Disable**, "Printer is offline" is displayed.

#### ▶▶▶ **Important**

- If you connect this machine to a network and use it, you can set **Auto Power Off** but the power will not switch off automatically.

## Reducing the Machine Noise

The silent function allows you to reduce the operating noise of this machine. Select when you wish to reduce the operating noise of the printer at night, etc.

Using this function may lower the print speed.

The procedure for using the quiet mode is as follows:



### Quiet Settings

1. Open the printer driver setup window
2. Click **Quiet Settings** on the **Maintenance** tab

The **Quiet Settings** dialog box opens.

#### ►► Note

- If the machine is off or if communication between the machine and the computer is disabled, an error message may appear because the computer cannot collect the machine status.

3. Set the quiet mode

If necessary, specify one of the following items:

#### **Do not use quiet mode**

Select this option when you wish to use the machine with volume of normal operating noise.

#### **Always use quiet mode**

Select this option when you wish to reduce the operating noise of the machine.

#### **Use quiet mode during specified hours**

Select this option when you wish to reduce the operating noise of the machine during a specified period of time.

Set the **Start time** and the **End time** of the quiet mode you wish to be activated. If both are set to the same time, the quiet mode will not function.

#### ►► Important

- You can set the quiet mode from the operation panel of the machine, the printer driver, or ScanGear (scanner driver).  
No matter how you use to set the quiet mode, the mode is applied when you

perform operations from the operation panel of the machine or printing and scanning from the computer.

- If you specify a time for **Use quiet mode during specified hours**, quiet mode is not applied to operations (copy, direct print, etc.) performed directly from the machine.

#### 4. Apply the settings

Make sure that the machine is on and click **OK**.

Click **OK** when the confirmation message appears.

The settings are enabled hereafter.

#### »» Note

- The effects of the quiet mode may be less depending on the print quality settings.

# Changing the Machine Operation Mode

If necessary, switch between various modes of machine operation.

The procedure for configuring **Custom Settings** is as follows:



## Custom Settings

1. Open the printer driver setup window
2. Make sure that the machine is on, and then click **Custom Settings** on the **Maintenance** tab

The **Custom Settings** dialog box opens.

### »» Note

- If the machine is off or if communication between the machine and the computer is disabled, an error message may appear because the computer cannot collect the machine status.  
If this happens, click **OK** to display the most recent settings specified on your computer.

3. If necessary, complete the following settings:

#### **Detects a printable disc in the disc tray**

Detects whether a printable disc is loaded on the disc tray during disc label printing and displays a message if a disc is not loaded.

Check this check box to print with detecting whether a printable disc is loaded.

Uncheck this check box to print without detecting whether a printable disc is loaded.

### »» Important

- If you leave this check box unchecked, the printer may print to the disc tray even if a printable disc is not loaded on the disc tray. Therefore, you should check this check box under normal circumstances.
- If you load a printable disc that has already been printed onto the disc tray, the printer may detect that no printable disc is loaded on the disc tray. In this case, uncheck this check box.



### **Prevent paper abrasion**

The machine can increase the gap between the print head and the paper during high-density printing to prevent paper abrasion.

Check this check box to prevent paper abrasion.

### **Align heads manually**

Usually, the **Print Head Alignment** function on the **Maintenance** tab is set to automatic head alignment, but you can change it to manual head alignment.

If the printing results of automatic print head alignment are not satisfactory, [perform manual head alignment](#).

Check this check box to perform the manual head alignment. Uncheck this check box to perform the automatic head alignment.

### **Rotate 90 degrees left when orientation is [Landscape]**

On the **Page Setup** tab, you can change the rotation direction of the **Landscape** in the **Orientation**.

To rotate the print data 90 degrees to the left during printing, select this item. To rotate the print data 90 degrees to the right during printing, clear this item.

### **»» Important**

- Do not change this setting while the print job is displayed in the print wait list. Otherwise, characters may be omitted or the layout may become corrupt.

### **Detect the paper width when printing from computer**

When you print from the computer, this function identifies the paper that was loaded into this machine.

When the paper width detected by the machine differ from the width of the paper specified in **Page Size** on the **Page Setup** tab, a message is displayed.

To use paper width detection when printing from the computer, select the check box.

### **»» Important**

- If you are using user-defined paper, use the **Custom Paper Size** to correctly set the size of the paper loaded in the machine.  
If an error message is displayed even though the same size that was set is loaded, clear the check box.

### **Ink Drying Wait Time**

You can set the length of the machine rest time until printing of the next page begins. Moving the slider to the right increases the pause time, and moving the slider to the left decreases the time.

If the paper gets stained because the next page is ejected before the ink on the

printed page dries, increase the ink drying wait time.  
Reducing the ink drying wait time speeds up printing.

#### 4. Apply the settings

Click **OK** and when the confirmation message appears, click **OK**.

The machine operates with the modified settings hereafter.

## Changing the Machine Settings Using the Operation Panel

- ➔ [Changing the Machine Settings Using the Operation Panel](#)
- ➔ [Print settings](#)
- ➔ [LAN settings](#)
- ➔ [Device user settings](#)
- ➔ [PictBridge print settings](#)
- ➔ [Language selection](#)
- ➔ [Home screen background color](#)
- ➔ [Firmware update](#)
- ➔ [Reset setting](#)
- ➔ [About ECO settings](#)
- ➔ [About Quiet setting](#)
- ➔ [Before Using the Machine with the Access Point Mode](#)

# Changing the Machine Settings Using the Operation Panel

This section describes the procedure to change the settings in the **Device settings** screen, taking the steps to specify **Extended copy amount** as an example.

1. [Make sure that the machine is turned on.](#)

2. Flick the HOME screen, then tap  **Setup**.

➔ [Using the Operation Panel](#)

3. Tap  **Device settings**.

The **Device settings** screen is displayed.

4. Tap the setting item to adjust.

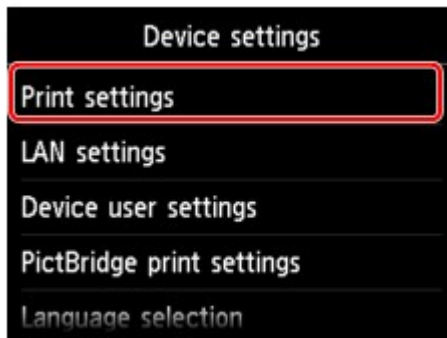

The setting screen for the selected item is displayed.

5. Tap the setting item.

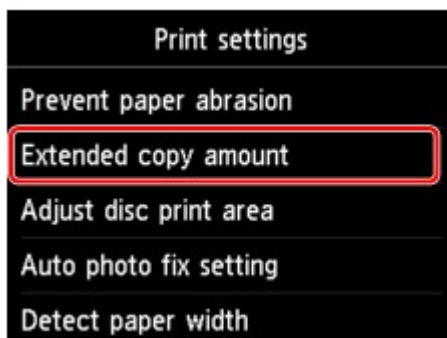

6. Tap the setting to specify.

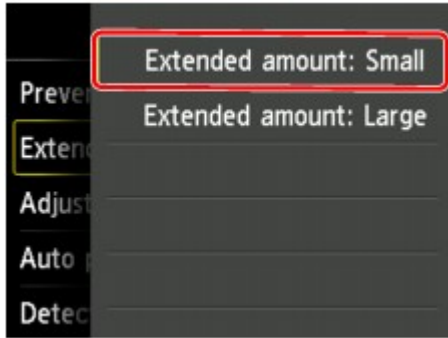

You can select the setting menus below.

- ➔ [Print settings](#)
- ➔ [LAN settings](#)
- ➔ [Device user settings](#)
- ➔ [PictBridge print settings](#)
- ➔ [Language selection](#)
- ➔ [Firmware update](#)
- ➔ [Home screen background color](#)
- ➔ [Reset setting](#)

#### ▶▶▶ Note

- You can use the machine considering the environment, such as setting 2-sided printing as default or enabling the machine to turn on/off automatically.
  - ➔ [About ECO settings](#)
- You can reduce the operating noise when printing at night.
  - ➔ [About Quiet setting](#)

## Print settings

- **Prevent paper abrasion**

Use this setting only if the print surface becomes smudged.

### »» Important

- Be sure to set this back to **OFF** after printing since it may result in lower printing speed or lower print quality.

- **Extended copy amount**

Selects the amount of image that extends off the paper when printing in borderless (full).

Slight cropping may occur at the edges since the copied image is enlarged to fill the whole page. You can change the width to be cropped from the borders of the original image as needed.

Cropped area will be larger if **Extended amount: Large** is selected.

### »» Important

- This setting can be applied under the following conditions:
  - performing borderless copying
  - Borderless is selected for Border when copying printed photos

### »» Note

- If printouts contain margins even though you are printing in Borderless, specifying **Extended amount: Large** for this setting may help solve the problem.

- **Adjust disc print area**

You can adjust the disc printing area if the image is not aligned with the printable disc.

You can adjust the printing area by 0.003 inches/0.1 mm between -0.03 inches/-0.9 mm and +0.03 inches/+0.9 mm.

- **Auto photo fix setting**

When **ON** is selected, you can select whether to print photos using the Exif information recorded in the image files in the following cases.

- **Auto photo fix** is selected for **Photo fix** when printing from a memory card.
- When **Auto photo fix** is selected for **Photo fix** in printing a photo in online photo album.
- The print setting on the PictBridge (Wireless LAN) compliant device is set to **Default\*** or **On** when printing with a PictBridge (Wireless LAN) compliant device.

\* When **Default** is selected for the print setting on the PictBridge (Wireless LAN) compliant device, select **Auto photo fix** for **Photo fix** in **PictBridge print settings**.

- **Detect paper width**

When you print from the machine with **ON** selected, the machine detects the paper width. If the size of loaded paper does not match with that specified with the machine, a message is displayed on the touch screen.

## LAN settings

- **Change wireless/wired**

Activates either wireless LAN or wired LAN. You can also deactivate wireless/wired LAN.

- **Wireless LAN setup**

Selects the setup method for wireless LAN connection.

### ▶▶▶ Note

- You can also enter this setting menu by selecting **Wireless LAN setup** on the HOME screen. In this case, activate wireless LAN.

When this menu is selected, the machine starts searching for a WPS-compatible access point. If the machine detects the access point, follow the on-screen instructions to set up wireless LAN. If an access point is not detected or if you select another setup method, select one of the setup methods below.

- **Standard setup**

Select when you perform settings for wireless LAN manually using the operation panel of the machine.

- **WPS**

Select when you perform settings for wireless LAN using Wi-Fi Protected Setup (WPS). Select **Push button method** or **PIN code method** according to the method your access point supports, then follow the on-screen instructions.

- **Other setup**

Select **Advanced setup** if you perform settings by entering the access point's settings directly on the machine. Select **Cableless setup** if you specify the settings of the access point information to the machine directly from a device (such as a smartphone) without operating the access point. Follow the on-screen instructions of the connecting device for the setup procedure.

- **Confirm LAN settings**

The list of wireless LAN settings of this machine is displayed on the touch screen. You can print the list from this setting menu.

- **WLAN setting list**

The list of wireless LAN settings of this machine is displayed on the touch screen.

The following setting items are displayed.

Items	Setting
<b>Connection</b>	Active/Inactive
<b>SSID</b>	XXXXXXXXXXXXXXXXXX XXXXXXXXXXXXXXXXXX
<b>Communication mode</b>	Infrastructure
<b>Channel</b>	XX
<b>Wireless LAN security</b>	Inactive/WEP(64bit)/WEP(128bit)/WPA-PSK(TKIP)/WPA-PSK(AES)/WPA2-PSK(TKIP)/WPA2-PSK(AES)

<b>IPv4 address</b>	XXX. XXX. XXX. XXX
<b>IPv4 subnet mask</b>	XXX. XXX. XXX. XXX
<b>IPv4 default gateway</b>	XXX. XXX. XXX. XXX
<b>IPv6 address</b>	XXXX: XXXX: XXXX: XXXX: XXXX: XXXX: XXXX: XXXX
<b>IPv6 subnet prefix length</b>	XXX
<b>IPv6 default gateway</b>	XXXX: XXXX: XXXX: XXXX: XXXX: XXXX: XXXX: XXXX
<b>MAC address</b>	XX:XX:XX:XX:XX:XX
<b>IPsec settings</b>	Enable (ESP)/Enable (ESP & AH)/Enable (AH)/Disable
<b>Pre-shared key</b>	XXXXXXXXXXXXXXXXXXXX
<b>Printer name</b>	XXXXXXXXXXXXXXXXXXXX
<b>Bonjour service name</b>	XXXXXXXXXXXXXXXXXXXX XXXXXXXXXXXXXXXXXXXX XXXXXXXXXXXXXXXXXXXX XXXXXXXXXXXXXXXXXXXX

("XX" represents alphanumeric characters.)

- **LAN setting list**

The list of wired LAN settings of this machine is displayed on the touch screen.

The following setting items are displayed.

<b>Items</b>	<b>Setting</b>
<b>Connection</b>	Active/Inactive
<b>IPv4 address</b>	XXX. XXX. XXX. XXX
<b>IPv4 subnet mask</b>	XXX. XXX. XXX. XXX
<b>IPv4 default gateway</b>	XXX. XXX. XXX. XXX
<b>IPv6 address</b>	XXXX: XXXX: XXXX: XXXX: XXXX: XXXX: XXXX: XXXX
<b>IPv6 subnet prefix length</b>	XXX
<b>IPv6 default gateway</b>	XXXX: XXXX: XXXX: XXXX: XXXX: XXXX: XXXX: XXXX
<b>MAC address</b>	XX:XX:XX:XX:XX:XX
<b>IPsec settings</b>	Enable (ESP)/Enable (ESP & AH)/Enable (AH)/Disable
<b>Pre-shared key</b>	XXXXXXXXXXXXXXXXXXXX
<b>Printer name</b>	XXXXXXXXXXXXXXXXXXXX



<b>Bonjour service name</b>	XXXXXXXXXXXXXX XXXXXXXXXXXXXX XXXXXXXXXXXXXX XXXXXXXXXXXXXX
-----------------------------	--

("XX" represents alphanumeric characters.)

- **Print LAN details**

You can print out the network settings of the machine such as its IP address and SSID.

For more information on the machine's network setting is printed out:

➔ [Printing Out Network Setting Information](#)

### ▶▶▶ Important

- This printout contains valuable information about your computer. Handle it with care.

- **Other settings**

- **Set printer name**

Specifies the printer name. You can use up to 15 characters for the name.

#### ▶▶▶ Note

- You cannot change this setting with the memory card inserted in the card slot.
- You cannot use the same printer name as that already used for other LAN connected devices.
- You cannot use a hyphen for the initial or last character of the printer name.

- **TCP/IP settings**

Performs IPv4 or IPv6 setting.

- **Set memory card sharing**

Selects whether to share the card slot with a LAN connected computer.

#### ▶▶▶ Note

- You cannot change this setting with the memory card inserted in the card slot.

- **WSD setting**

Setting items when you use WSD (one of the network protocols supported in Windows 8, Windows 7, and Windows Vista).

#### Enable/disable WSD

Selects whether WSD is enabled or disabled.

#### ▶▶▶ Note

- When this setting is activated, the printer icon is displayed on the Network Explorer in Windows 8, Windows 7 and Windows Vista.

#### WSD scan from this device

Selecting **Enable** allows you to transfer the scanned data to the computer using WSD.

#### Timeout setting

Specifies the timeout length.

- **Bonjour settings**

Setting items for LAN using Bonjour for Mac OS.

### **Enable/disable Bonjour**

Selecting **Enable** allows you to use Bonjour to perform the network settings.

### **Service name**

Specifies the Bonjour service name. You can use up to 48 characters for the name.

### **»» Note**

- You cannot use the same service name as that already used for other LAN connected devices.

#### ◦ **LPR protocol setting**

Activates/deactivates the LPR setting.

#### ◦ **PictBridge communication**

Setting items for printing from a PictBridge (Wireless LAN) compliant device.

#### **Enable/disable communication**

Selecting **Enable** allows you to print from a PictBridge (Wireless LAN) compliant device.

#### **Timeout setting**

Specifies the timeout length.

#### ◦ **Wireless LAN DRX setting**

Selecting **Enable** allows you to activate discontinuous reception when using wireless LAN. It allows you to save electricity.

### **»» Note**

- Depending on the access point you are using, discontinuous reception may not be activated even though **Enable** is selected.
- Discontinuous reception is activated only while the machine is on standby. (The touch screen is in the screen saver mode.)

#### ◦ **Wired LAN DRX setting**

Selecting **Enable** allows you to activate discontinuous reception when the machine is connected to a device compatible with wired LAN. It allows you to save electricity.

#### ◦ **Access point mode settings**

When you use the machine as an access point, specify the access point name and the security setting.

➡ [Before Using the Machine with the Access Point Mode](#)

## Device user settings

- **Date display format**

Changes the display format of dates when printed.

### ▶▶▶ Note

- When **ON** is selected for **Print date** on the print settings screen in printing from a memory card, the date is printed in the date display format you selected.

➔ [Setting Items](#)

- **Read/write attribute**

Selects whether to allow data to be written onto memory cards from a computer.

### ▶▶▶ Important

- Remove the memory card before changing this setting.
  - ➔ [Setting Up the Card Slot as the Memory Card Drive of the Computer](#)
- If you set this setting to **Writable from USB PC** or **Writable from LAN PC**, you cannot print photos on a memory card using the operation panel of the machine. After you finish operation of the memory card dedicated drive, be sure to set it back to **Not writable from PC**. When you turn off the machine, **Writable from USB PC** or **Writable from LAN PC** will be canceled and the setting is returned to **Not writable from PC** when you turn on the machine next time.
- When **Writable from USB PC** or **Writable from LAN PC** is selected, the auto power off setting is inactive.

For details on the auto power off setting:

➔ [About ECO settings](#)

- **Volume control**

Selects the volume.

- **Keypad volume**

Selects the beep volume when tapping the touch screen or the buttons on the operation panel.

- **Alarm volume**

Selects the alarm volume.

- **Device info sending setting**

Selects whether you will send the printer usage information to Canon server. The information sent to Canon will be utilized to develop better products. Select **Agree** to send the printer usage information to Canon server.

## PictBridge print settings

You can change the print settings when printing from a PictBridge (Wireless LAN) compliant device.

Set the print settings to **Default** on the PictBridge (Wireless LAN) compliant device when you want to print according to the settings on the machine.

➔ [PictBridge print settings Screen](#)

➔ [Disc label print setting Screen](#)

To change print settings from the PictBridge (Wireless LAN) compliant device:

➔ Settings on a PictBridge (Wireless LAN) Compliant Device

### PictBridge print settings Screen

Select the print quality, when printing directly from a PictBridge (Wireless LAN) compliant device.



#### 1. Page size

Select the paper size when printing directly from a PictBridge (Wireless LAN) compliant device.

When you perform PictBridge (Wireless LAN) settings from the machine, set **Paper size** to **Default** on the PictBridge (Wireless LAN) compliant device.

#### 2. Type (Media type)

Select the media type when printing directly from a PictBridge (Wireless LAN) compliant device.

When you perform PictBridge (Wireless LAN) settings from the machine, set **Paper type** to **Default** on the PictBridge (Wireless LAN) compliant device.

#### 3. Print qlty (Print quality)

Select the print quality when printing directly from a PictBridge (Wireless LAN) compliant device.

#### 4. Border (Bordered/Borderless print)

Select the bordered/borderless layout.

When you perform PictBridge (Wireless LAN) settings from the machine, set **Layout** to **Default** on the PictBridge (Wireless LAN) compliant device.

#### 5. Photo fix

When **Auto photo fix** is selected, the scene or person's face of a shot photo is recognized and the most suitable correction for each photo is made automatically. It makes a darkened face by backlight

brighter to print. It also analyzes a scene such as scenery, night scene, person, etc. and corrects each scene with the most suitable color, brightness, or contrasts automatically to print.

»»» **Note**

- As a default, photos on a PictBridge (Wireless LAN) compliant device are printed with auto correction applied.
- If **No correction** is selected, photos are printed without correction.

## 6. Red-EyeCorrection

Select **ON** to correct red eyes in portraits caused by flash photography.

Depending on the type of the photo, red eyes may not be corrected or parts other than the eyes may be corrected.

7. Tap to specify the print settings.

## Disc label print setting Screen

The **Set disc print area** screen is displayed, and you can perform settings for printing on a printable disc from a PictBridge (Wireless LAN) compliant device.

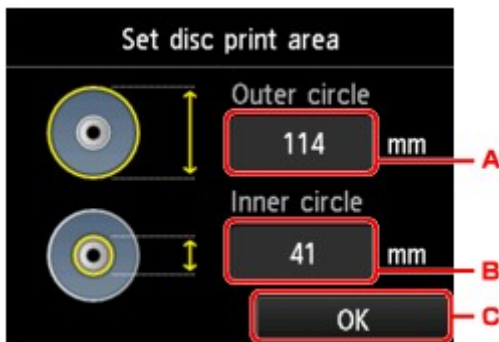

Follow the procedure below to perform disc label print setting.

1. Adjust the printing area (the outer/inner diameter of the printable disc).

- A. Tap to specify the outer diameter.
- B. Tap to specify the inner diameter.
- C. Tap to specify the printing area.

»»» **Note**

- Measure the outer and inner diameters of the printing surface of the printable disc and make sure you set a value smaller than the measured value for the outer diameter, and a value larger than the measured value for the inner diameter.
- Contact the manufacturers of printable discs for details.

2. Select the type of the printable disc you use.

»»» **Note**

- If your printable disc is the recommended disc, tap **Recommended disc** for the suitable density printing. If not, tap **Other disc**.

## **Language selection**

Changes the language for the messages and menus on the touch screen.

## Home screen background color

Selects the background color of the HOME screen. You can select black or white.

# Firmware update

You can update the firmware of the machine, check the firmware version, or perform settings of a notification screen, a DNS server and a proxy server.

## ▶▶▶ Note

- Only **Check current version** is available when **Disable LAN** is selected for **Change wireless/wired in LAN settings**.

- **Install update**

Performs the firmware update of the machine. If you select **Yes**, the firmware update starts. Follow the on-screen instructions to perform update.

## ▶▶▶ Important

- When you use this function, make sure that the machine is connected to the Internet.

## ▶▶▶ Note

- If the firmware update is not complete, check the following and take an appropriate action.
  - Check the network settings such as an access point or a router.
  - If **Cannot connect to the server**. is displayed on the touch screen, tap **OK**, then try again after a while.

- **Check current version**

You can check the current firmware version.

- **Update notification setting**

When **ON** is selected and the firmware update is available, the screen to inform you of the firmware update is displayed on the touch screen.

- **DNS server setup**

Performs settings for a DNS server. Select **Auto setup** or **Manual setup**. If you select **Manual setup**, follow the display on the touch screen to perform settings.

- **Proxy server setup**

Performs settings for a proxy server. Follow the display on the touch screen to perform settings.



# Reset setting

You can change the settings back to the default.

- **Web service setup only**

Reverts the Web service settings back to the default.

- **LAN settings only**

Reverts the LAN settings back to the default.

- **Settings only**

Reverts the settings such as the paper size or media type back to the default.

- **Device info sending setting only**

Reverts only the device information sending settings.

- **Reset all**

Reverts all settings you made to the machine back to default.

## **Note**

- You cannot change the following setting items back to the default:
  - The language displayed on the touch screen
  - The background color of the HOME screen
  - The current position of the print head
  - The **Read/write attribute** setting

## About ECO settings

This setting allows you to use automatic duplex printing as a default to save paper and to turn the machine on/off automatically to save electricity.

➔ [Using Duplex Printing](#)

➔ [Using Power Saving Function](#)

### Using Duplex Printing

Follow the procedure below to use duplex printing.

1. [Make sure that the machine is turned on.](#)

2. Flick the HOME screen, then tap  **ECO settings**.

➔ [Using the Operation Panel](#)

3. Tap **Two-sided printing setting**.

4. Specify the settings as necessary.



- A. Tap to select two-sided copying as a default.
- B. Tap to select duplex printing PDF files saved on a memory card as a default.
- C. Tap to select two-sided printing of template forms on the machine as a default.
- D. Tap to specify the print settings.

#### ➤➤➤ Note

- When duplex printing is selected, the  icon is displayed on the setting items for duplex printing on each print setting screen.

### Using Power Saving Function

Follow the procedure below to use power saving function.

1. [Make sure that the machine is turned on.](#)

2. Flick the HOME screen, then tap  **ECO settings**.

➔ [Using the Operation Panel](#)

3. Tap **Energy saving settings**.

4. Specify the settings as necessary.

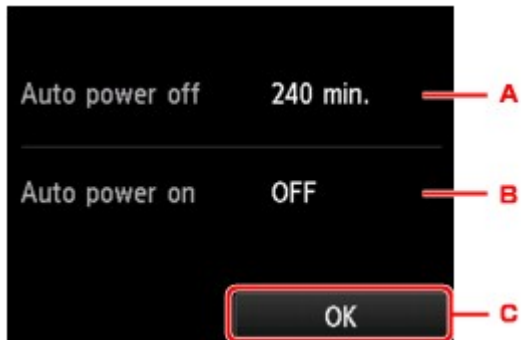

A. Tap to specify the length of time to turn the machine off automatically when no operation is made or no printing data is sent to the machine.

#### ➤➤➤ **Note**

- The Auto power off setting is invalid under the following conditions.
  - When using the machine via a network and the network connection is enabled  
You can check the connection status from **WLAN setting list** in **Confirm LAN settings** under **LAN settings**.
  - When **Writable from USB PC** or **Writable from LAN PC** is selected for **Read/write attribute** under **Device user settings**.

B. Tap to select the setting.

Selecting **ON** enables the machine to turn on automatically when a scanning command from a computer or printing data is sent to the machine.

C. Tap to confirm the settings.

## About Quiet setting

Enables this function on the machine if you want to reduce the operating noise, such as when printing at night.

Follow the procedure below to perform setting.

1. [Make sure that the machine is turned on.](#)

2. Flick the HOME screen, then tap  **Quiet setting**.

➔ [Using the Operation Panel](#)

3. Tap **Use quiet mode**.

The confirmation screen is displayed, then the  icon appears as the **Quiet setting** menu icon.

Activate this setting to reduce the operating noise while printing is in progress.

### ▶▶▶ Important

- Operating speed may be reduced compared to when **Do not use quiet mode** is selected.
- This function may not be so effective depending on the machine's setting. Furthermore, certain noise, such as when the machine is preparing for printing, is not reduced.

### ▶▶▶ Note

- You can set the quiet mode from the operation panel of the machine, the printer driver, or ScanGear (scanner driver). No matter how you use to set the quiet mode, the mode is applied when you perform operations from the operation panel of the machine or printing and scanning from the computer.

## Before Using the Machine with the Access Point Mode

When you use the machine with the access point mode, be sure to specify the access point name of the machine and the security setting in advance.

### Setting Procedure When Using the Machine with the Access Point Mode

1. [Make sure that the machine is turned on.](#)

2. Flick the HOME screen, then tap  **Setup**.

➔ [Using the Operation Panel](#)

3. Tap  **Device settings**.

4. Tap **LAN settings**.

5. Tap **Other settings**.

6. Tap **Access point mode settings**.

The screen to specify the access point name is displayed.

7. Tap the touch screen.

8. Enter the access point name.

Enter the access point name when you use the machine as an access point.

9. Tap **Apply** to finish entering the name.

10. Tap **OK** to finish specifying the access point name.

11. Select the security setting.

#### **Disable**

Finishes the access point settings without specifying the security setting.

#### **WPA2-PSK (AES)**

Specifies the security setting applying WPA2-PSK (AES). Proceed to the next step when the screen to specify the passphrase.

12. Tap the touch screen.

13. Enter the passphrase.

14. Tap **Apply** to finish entering the passphrase.

15. Tap **OK** to finish specifying the passphrase setting.

For details on printing or scanning with the access point mode:

- ➡ Printing with the Access Point Mode
- ➡ Scanning with the Access Point Mode

## **Restrictions on Using the Access Point Mode**

When you use the machine with the access point mode, note the following.

- Up to 5 external devices (ex: smartphone) can be connected to the machine.
- While you are using the machine with the access point mode, you cannot perform the operations below.
  - Operations using the operation panel of the machine (ex: copying or scanning)
  - Operations necessary to connect the machine to the Internet
  - Changing the network settings of the machine or displaying the network settings

## Setting Up the Card Slot as the Memory Card Drive of the Computer

➔ [Setting Up the Card Slot as the Memory Card Drive of the Computer](#)

# Setting Up the Card Slot as the Memory Card Drive of the Computer



The card slot of the machine can also be used as the memory card drive of the computer.

## ▶▶▶ Note

- When you use the machine over LAN, the card slot of the machine can be used as the network drive.  
➔ [Using the Card Slot over a Network](#)

## ▶▶▶ Important

- When **Read/write attribute** in **Device user settings** under **Device settings** is set to **Writable from USB PC** or **Writable from LAN PC** using the operation panel of the machine, you cannot print photos on a memory card using the operation panel of the machine. After using the card slot as the memory card drive of the computer, remove the memory card, then be sure to set **Read/write attribute** to **Not writable from PC**. When you turned off the machine, **Writable from USB PC** or **Writable from LAN PC** will be canceled and the setting is returned to **Not writable from PC** when you turn on the machine next time.

1. [Make sure that the machine is turned on.](#)
2. Make sure that the memory card is not set.  
If the memory card is set, remove it from the card slot.  
➔ [Inserting the Memory Card](#)
3. Flick the HOME screen, then tap  **Setup**.  
➔ [Using the Operation Panel](#)
4. Tap  **Device settings**.
5. Tap **Device user settings**.
6. Tap **Read/write attribute**.
7. Check the message that is displayed, then tap **OK**.
8. Tap a read/write attribute to specify the setting.

### **Writable from USB PC**

The card slot is used as the memory card drive of a computer connected to the machine via USB. Data can be written on the memory card from the computer.

### **Writable from LAN PC**

The card slot is used as the memory card drive of a computer connected to the machine via a network. Data can be written on the memory card from the computer.



### Not writable from PC

The card slot is used only for reading. Be sure to select this mode when printing photos from a memory card.

#### »» Important

- When **Writable from USB PC** or **Writable from LAN PC** is selected, the auto power off setting is inactive.

For details on the auto power off setting:

➡ [About ECO settings](#)

#### »» Important

- If you use the card slot as the memory card drive of the computer, you need to perform a "safe removal" operation on your computer before physically removing the memory card from your machine.

Right-click the  **Removable Disk** icon and click **Eject**. If **Eject** is not displayed on the screen, confirm that the **Access** lamp is not flashing and remove the memory card.

Over a network, the removal operation is not needed.

## Information about Network Connection

➔ [Useful Information about Network Connection](#)

## Useful Information about Network Connection

- ➔ [Initial Values Set at Factory \(Network\)](#)
- ➔ [Connecting the Machine to the Computer Using a USB Cable](#)
- ➔ [When Detecting the Printers Have the Same Name during Setup](#)
- ➔ [Connecting to Other Computer with LAN/Changing the Connection Method from USB to LAN](#)
- ➔ [Printing Out Network Setting Information](#)

## Initial Values Set at Factory (Network)

Item	Initial Values
Change wireless/wired	Disable LAN
SSID	BJNPSETUP
Communication mode	Infrastructure
Wireless LAN security	Disable
IP address (IPv4)	Auto setup
IP address (IPv6)	Auto setup
Set printer name*	XXXXXXXXXXXX
Enable/disable IPv6	Enable
Set memory card sharing	Enable
Enable/disable WSD	Enable
Timeout setting	1 minute
Enable/disable Bonjour	Enable
Service name	Canon MG7100 series
LPR protocol setting	Enable
PictBridge communication	Enable
Wireless LAN DRX setting	Enable
Wired LAN DRX setting	Enable

("XX" represents alphanumeric characters.)

\* The initial value in this item varies by machine. You can check the value in this item using the operation panel on the machine.

➔ [LAN settings](#)

## Connecting the Machine to the Computer Using a USB Cable

Connect the machine and the computer using a USB cable as the illustration below. The USB port is located on the rear of the machine.

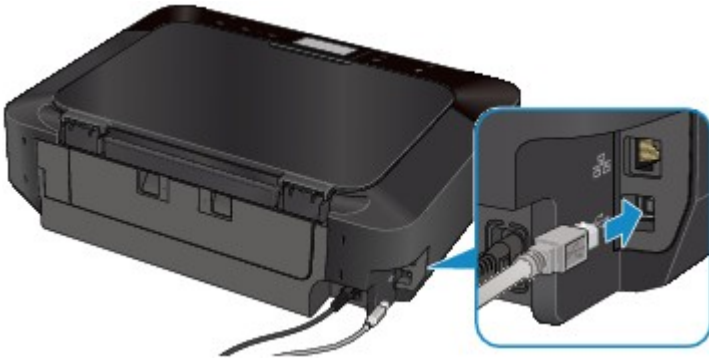

## When Detecting the Printers Have the Same Name during Setup

When the printer is detected during setup, you may see multiple printers of the same name on the detection result screen.

Select a printer with checking the MAC address set to the printer against the MAC address on detection result screen.

To check the MAC address of the printer, print out the network setting information using the operation panel of the printer.

➡ [Printing Out Network Setting Information](#)

Additionally, you can check the network setting information on the touch screen of the printer. Select **WLAN setting list** from **Confirm LAN settings** in **LAN settings** under **Device settings**, and check the item displayed on the touch screen.

➡ [LAN settings](#)

## **Connecting to Other Computer with LAN/Changing the Connection Method from USB to LAN**

To add the computer connecting the printer with LAN or to change the connection method between the printer and the computer from USB to LAN, perform setup with the Setup CD-ROM or perform it according to the instructions on our website.

### **Connecting to Other Computer with LAN**

To add the computer connecting the printer with LAN, perform setup with the Setup CD-ROM or perform it according to the instructions on our website.

### **Changing the Connection Method from USB to LAN**

To change the connection method between the printer and the computer from USB to LAN, perform setup with the Setup CD-ROM or perform it according to the instructions on our website.

To change the connection method to LAN while you are using the printer with USB connection, perform setup again with the Setup CD-ROM or perform it again according to the instructions on our website and select **Change Connection Method**.

# Printing Out Network Setting Information

You can print out the network settings of the machine such as its IP address and SSID.

## »» Important

- This print out contains valuable information about your computer. Handle it with care.

1. [Make sure that the machine is turned on.](#)
2. [Load a sheet of A4 or Letter-sized plain paper.](#)
3. Flick the HOME screen, then tap  **Setup.**

➔ [Using the Operation Panel](#)

The menu screen is displayed.

4. Tap  **Device settings.**
5. Tap **LAN settings.**
6. Tap **Confirm LAN settings.**
7. Tap **Print LAN details.**
8. Tap **Yes.**

The machine starts printing the network setting information.

The following information on the machine's network setting is printed out.

Item	Explanations of the item	Setting
Wireless LAN	Wireless LAN	Enable/Disable
Connection	Status of the Wireless LAN	Active/Inactive
MAC Address	MAC Address	XX:XX:XX:XX:XX:XX
SSID	SSID	SSID of the wireless LAN
Communication Mode	Communication Mode	Infrastructure
Channel	Channel	XX (1 to 13)
Encryption	Method of the Encryption	none/WEP/TKIP/AES
WEP Key Length	WEP Key Length	Inactive/128/64
Authentication	Method of the Authentication	none/auto/open/shared/WPA-PSK/WPA2-PSK



Signal Strength	Signal Strength	0 to 100 [%]
TCP/IP Version	TCP/IP Version	IPv4 & IPv6/IPv4
IPv4 IP Address	Selected IP Address (IPv4)	XXX.XXX.XXX.XXX
IPv4 Default Gateway	Default Gateway (IPv4)	XXX.XXX.XXX.XXX
Subnet Mask	Subnet Mask	XXX.XXX.XXX.XXX
IPv6 IP Address *1	Selected IP Address (IPv6)	XXXX:XXXX:XXXX:XXXX XXXX:XXXX:XXXX:XXXX
IPv6 Default Gateway *1	Default Gateway (IPv6)	XXXX:XXXX:XXXX:XXXX XXXX:XXXX:XXXX:XXXX
Subnet Prefix Length*1	Subnet Prefix Length	XXX
IPsec*2	IPsec setting	Active
Security Protocol*2	Method of the Security Protocol	ESP/ESP & AH/AH
Wireless LAN DRX	Discontinuous reception (wireless LAN)	Enable/Disable
Wired LAN	Wired LAN	Enable/Disable
Connection	Status of the Wired LAN	Active/Inactive
MAC Address	MAC Address	XX:XX:XX:XX:XX:XX
TCP/IP Version	TCP/IP Version	IPv4 & IPv6/IPv4
IPv4 IP Address	Selected IP Address (IPv4)	XXX.XXX.XXX.XXX
IPv4 Default Gateway	Default Gateway (IPv4)	XXX.XXX.XXX.XXX
Subnet Mask	Subnet Mask	XXX.XXX.XXX.XXX
IPv6 IP Address *1	Selected IP Address (IPv6)	XXXX:XXXX:XXXX:XXXX XXXX:XXXX:XXXX:XXXX
IPv6 Default Gateway *1	Default Gateway (IPv6)	XXXX:XXXX:XXXX:XXXX XXXX:XXXX:XXXX:XXXX
Subnet Prefix Length*1	Subnet Prefix Length	XXX
IPsec*2	IPsec setting	Active
Security Protocol*2	Method of the Security Protocol	ESP/ESP & AH/AH
Wired LAN DRX	Discontinuous reception (wired LAN)	Enable/Disable
Other Settings	Other settings	-
Printer Name	Printer name	Printer name (Up to 15 characters)
Shared Memory Card	Memory card sharing	Enable/Disable
WSD	WSD setting	Enable/Disable

WSD Timeout	Timeout	1/5/10/15/20 [min]
LPR Protocol	LPR protocol setting	Enable/Disable
Bonjour	Bonjour setting	Enable/Disable
Bonjour Service Name	Bonjour service name	Bonjour service name (Up to 52 characters)
PictBridge Commun.	PictBridge Communication	Enable/Disable
DNS Server	Getting DNS Server automatically	Auto/Manual
Primary Server	Primary server address	XXX.XXX.XXX.XXX
Secondary Server	Secondary server address	XXX.XXX.XXX.XXX
Proxy Server	Proxy Server setting	Enable/Disable
Proxy Port	Specifying Proxy Port	1 to 65535
Proxy Address	Proxy Address	XXXXXXXXXXXXXXXXXXXXXXX
IP Address Filtering	IP Address Filtering	Enable/Disable

("XX" represents alphanumeric characters.)

\*1 Only when IPv6 is activated, the status of the network is printed.

\*2 Only IPv6 and the IPsec setting are activated, the status of the network is printed.

## About Network Communication

- ➔ [Changing and Confirming Network Settings](#)
- ➔ [Screens for Network Connection of IJ Network Tool](#)
- ➔ [Other Screens of IJ Network Tool](#)
- ➔ [Appendix for Network Communication](#)

## Changing and Confirming Network Settings

- ➔ [IJ Network Tool](#)
- ➔ [Changing the Settings in the Wireless LAN Sheet](#)
- ➔ [Changing the WEP Detailed Settings](#)
- ➔ [Changing the WPA or WPA2 Detailed Settings](#)
- ➔ [Changing the Settings in the Wired LAN Sheet](#)
- ➔ [Changing the Settings in the Admin Password Sheet](#)
- ➔ [Monitoring Wireless Network Status](#)
- ➔ [Initializing the Network Settings of the Machine](#)
- ➔ [Viewing the Modified Settings](#)

# IJ Network Tool

IJ Network Tool is a utility that enables you to display and modify the machine network settings. It is installed when the machine is set up.

## »» Important

- To use the machine over LAN, make sure you have the equipment necessary for the connection type, such as an access point or a LAN cable.
- Do not start up IJ Network Tool while printing.
- Do not print when IJ Network Tool is running.
- If the firewall function of your security software is turned on, a message may appear warning that Canon software is attempting to access the network. If the warning message appears, set the security software to always allow access.
- IJ Network Tool has been verified to work on Windows XP, however, it does not support Fast User Switching. It is recommended to exit IJ Network Tool when switching users.

## Starting up IJ Network Tool

1. Start up IJ Network Tool as shown below.

- In Windows 8, select **IJ Network Tool** on the **Start** screen to start IJ Network Tool. If **IJ Network Tool** is not displayed on the **Start** screen, select the **Search** charm, then search for "IJ Network Tool".
- In Windows 7, Windows Vista, or Windows XP, click **Start** and select **All programs, Canon Utilities, IJ Network Tool**, and then **IJ Network Tool**.

## »» Note

- You can also start up IJ Network Tool by clicking  **Network Settings** from **Device Settings & Maintenance** on Quick Menu.

## Changing the Settings in the Wireless LAN Sheet

To change the wireless network settings of the printer, connect the printer and the computer with a USB cable temporarily. If you modify the wireless network settings of the computer over wireless connection without USB connection, your computer may not be able to communicate with the machine after modifying the settings.

### ▶▶▶ Note

- This screen is not available depending on the printer you are using.
- Activate the wireless LAN setting of the printer to change the settings in the **Wireless LAN** sheet.

1. [Start up IJ Network Tool.](#)

2. Select the printer in **Printers:**.

When the printer is connected to the computer with a USB cable temporarily, select the printer with "USBnnn" (where "n" is a number) appearing in the **Port Name** column.

3. Select **Configuration...** from the **Settings** menu.

4. Click the **Wireless LAN** tab.

The **Wireless LAN** sheet is displayed.

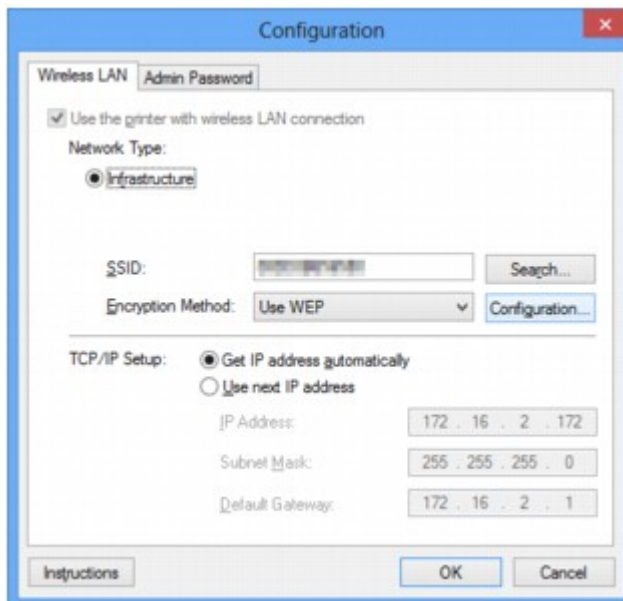

For details on the **Wireless LAN** sheet, see [Wireless LAN Sheet](#).

5. Change the settings or confirm.

#### SSID:

Enter the same value that was set for the target access point.

When the printer is connected with USB, the **Search** screen appears by clicking **Search...**. Set the SSID of the access point by selecting the one of the detected access points.

➡ [Search Screen](#)

## »» Note

- Enter the same SSID that the access point is configured to use. The SSID is case-sensitive.

### Encryption Method:

Select the encryption method used over the wireless LAN.

You can change WEP settings with selecting **Use WEP** and clicking **Configuration...**

➔ [Changing the WEP Detailed Settings](#)

You can change WPA or WPA2 settings with selecting **Use WPA** or **Use WPA2** and clicking **Configuration...**

➔ [Changing the WPA or WPA2 Detailed Settings](#)

## »» Important

- If all encryption types of the access point, printer, or computer do not match, the printer cannot communicate with the computer. If the printer cannot communicate with the computer after the encryption type of the printer was switched, make sure that encryption types for the computer and the access point matches that set to the printer.
- If you connect to a network that is not protected with security measures, there is a risk of disclosing data such as your personal information to a third party.

### TCP/IP Setup:

Sets the IP address of the printer to be used over the LAN. Set a value appropriate for your network environment.

## 6. Click **OK**.

After changing configuration, a screen is displayed asking you for confirmation before the settings are sent to the printer. If you click **Yes**, the settings are sent to the printer and the **Transmitted Settings** screen is displayed.

## »» Note

- Changing the network settings with the USB cable temporarily may switch the default printer. In this case, reset **Set as Default Printer**.

# Changing the WEP Detailed Settings

## ▶▶▶ Note

- This screen is not available depending on the printer you are using.

To change the wireless network settings of the printer, connect the printer and the computer with a USB cable temporarily. If you modify the wireless network settings of the computer over wireless connection without USB connection, your computer may not be able to communicate with the machine after modifying the settings.

1. [Start up IJ Network Tool.](#)

2. Select the printer in **Printers:**.

When the printer is connected to the computer with a USB cable temporarily, select the printer with "USBnnn" (where "n" is a number) appearing in the **Port Name** column.

3. Select **Configuration...** from the **Settings** menu.

4. Click the **Wireless LAN** tab.

5. Select **Use WEP** in **Encryption Method:** and click **Configuration....**

The **WEP Details** screen is displayed.

6. Change the settings or confirm.

When changing the password (WEP key), the same change must be made to the password (WEP key) of the access point.

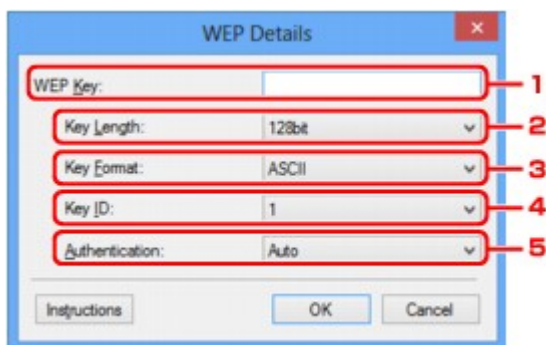

### 1. **WEP Key:**

Enter the same key as the one set to the access point.

The number of characters and character type that can be entered differ depending on the key length and key format.

		Key Length	
		64bit	128bit
Key Format	ASCII	5 characters	13 characters



	Hexadecimal ( <b>Hex</b> )	10 digits	26 digits
--	----------------------------	-----------	-----------

2. **Key Length:**

Select either **64bit** or **128bit**.

3. **Key Format:**

Select either **ASCII** or **Hex**.

4. **Key ID:**

Select the Key ID (index) set to the access point.

5. **Authentication:**

Select the authentication method to authenticate the printer's access to the access point.

Normally, select **Auto**. If you want to specify the method manually, select **Open System** or **Shared Key** according to the setting of the access point.

7. Click **OK**.

**Important**

- If the printer cannot communicate with the computer after the encryption type of the printer was switched, make sure that encryption types for the computer and the access point matches that set to the printer.

**Note**

- Changing the network settings with the USB cable temporarily may switch the default printer. In this case, reset **Set as Default Printer**.

# Changing the WPA or WPA2 Detailed Settings

## ▶▶▶ Note

- This screen is not available depending on the printer you are using.

To change the wireless network settings of the printer, connect the printer and the computer with a USB cable temporarily. If you modify the wireless network settings of the computer over wireless connection without USB connection, your computer may not be able to communicate with the machine after modifying the settings.

The example screenshots in this section refer to the WPA detailed settings.

1. [Start up IJ Network Tool.](#)

2. Select the printer in **Printers:**.

When the printer is connected to the computer with a USB cable temporarily, select the printer with "USBnnn" (where "n" is a number) appearing in the **Port Name** column.

3. Select **Configuration...** from the **Settings** menu.

4. Click the **Wireless LAN** tab.

5. Select **Use WPA** or **Use WPA2** in **Encryption Method:** and click **Configuration....**

The **WPA Details** screen is displayed (For WPA2, the **WPA2 Details** screen is displayed).

If encryption is not set to the printer, the **Authentication Type Confirmation** screen is displayed. Go to step 7.

6. Click **Change Settings....**

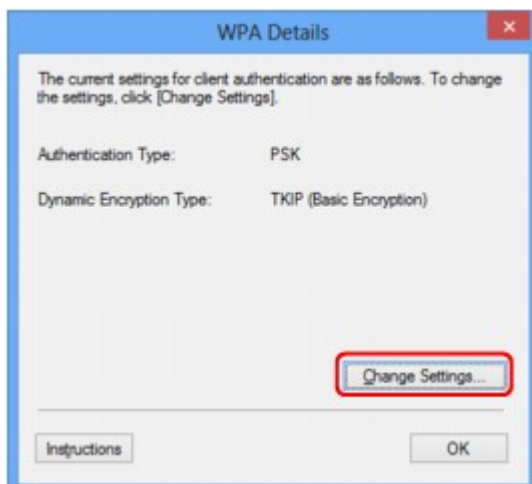

7. Check the client authentication type and click **Next>**.

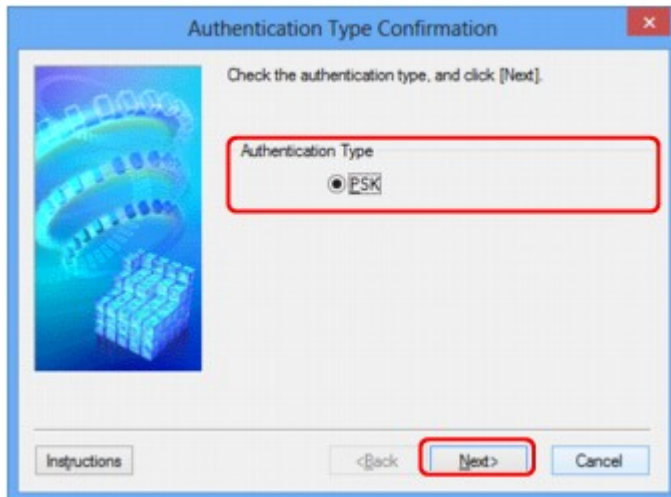

8. Enter the passphrase, confirm the type of dynamic encryption and click **Next>**.

Enter the passphrase set to the access point. The passphrase should be a string of 8 to 63 alphanumeric characters or a 64-digit hexadecimal value.

If you do not know the access point passphrase, refer to the instruction manual provided with the access point or contact its manufacturer.



9. Click **Finish**.

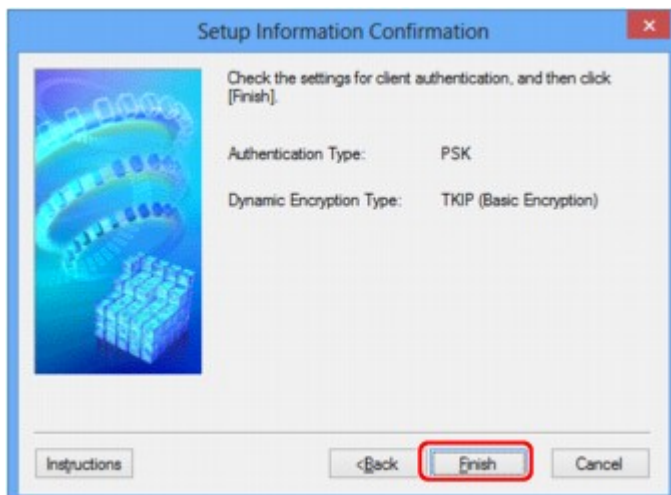

**»» Important**

- If the printer cannot communicate with the computer after the encryption type of the printer was switched, make sure that encryption types for the computer and the access point matches that set to the printer.

**»» Note**

- Changing the network settings with the USB cable temporarily may switch the default printer. In this case, reset **Set as Default Printer**.

# Changing the Settings in the Wired LAN Sheet

## ▶▶▶ Note

- This screen is not available depending on the printer you are using.
- Activate the wired LAN setting of the printer to change the settings in the **Wired LAN** sheet.

1. [Start up IJ Network Tool.](#)
2. Select the printer in **Printers:**.
3. Select **Configuration...** from the **Settings** menu.
4. Click the **Wired LAN** tab.

The **Wired LAN** sheet is displayed.

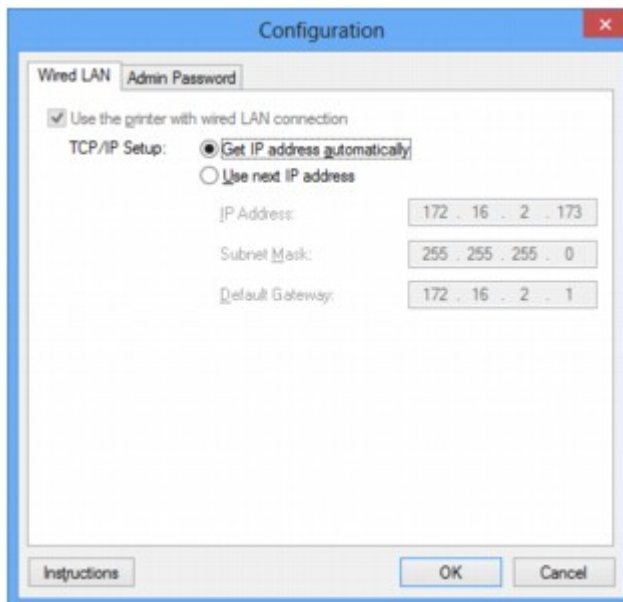

For details on the **Wired LAN** sheet, see [Wired LAN Sheet](#).

5. Change the settings or confirm.

Sets the IP address of the printer to be used over the LAN. Set a value appropriate for your network environment.

6. Click **OK**.

After changing configuration, a screen is displayed asking you for confirmation before the settings are sent to the printer. If you click **Yes**, the settings are sent to the printer and the **Transmitted Settings** screen is displayed.

## Changing the Settings in the Admin Password Sheet

1. [Start up IJ Network Tool.](#)
2. Select the printer in **Printers:**.
3. Select **Configuration...** from the **Settings** menu.
4. Click the **Admin Password** tab.

The **Admin Password** sheet is displayed.

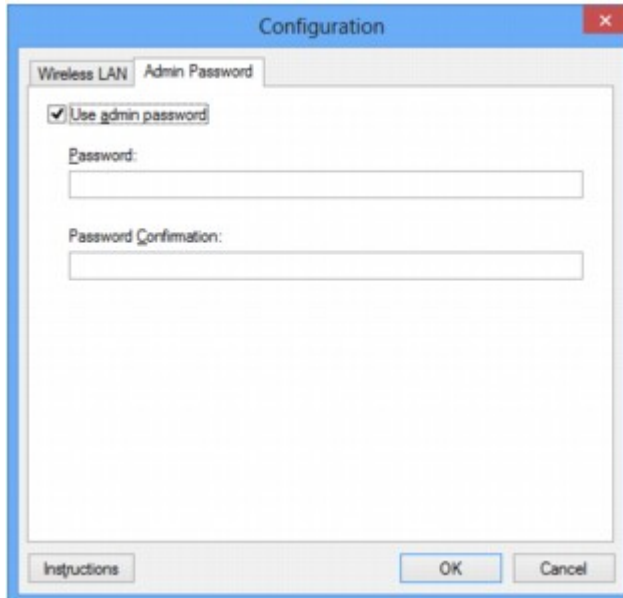

For details on the **Admin Password** sheet, see [Admin Password Sheet](#).

5. Change the settings or confirm.

To use admin password, select the **Use admin password** check box and enter a password.

### »» Important

- The password should consist of alphanumeric characters and be no longer than 32 characters. The password is case-sensitive. Do not forget the password you set.

6. Click **OK**.

A screen is displayed asking you for confirmation before the settings are sent to the printer. If you click **Yes**, the settings are sent to the printer and the **Transmitted Settings** screen is displayed.

# Monitoring Wireless Network Status

## ►► Note

- This screen is not available depending on the printer you are using.
- When using the machine over the wired LAN, you cannot monitor network status.

1. [Start up IJ Network Tool.](#)
2. Select the printer in **Printers:**.
3. Select **Status** from the **View** menu.

The **Status** screen is displayed and you can check the printer status and connection performance.

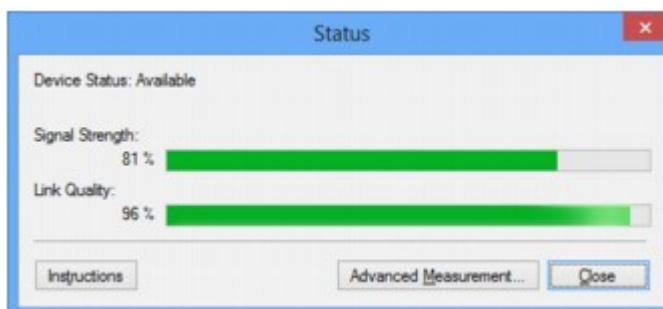

## ►► Important

- If the indicated value is low, move your printer closer to the wireless network device.

4. If you measure the connection performance in detail, click **Advanced Measurement....**

The **Connection Performance Measurement** screen is displayed.

5. Click **Next>**.

The measurement starts and the status displays. Measurement takes a few minutes.

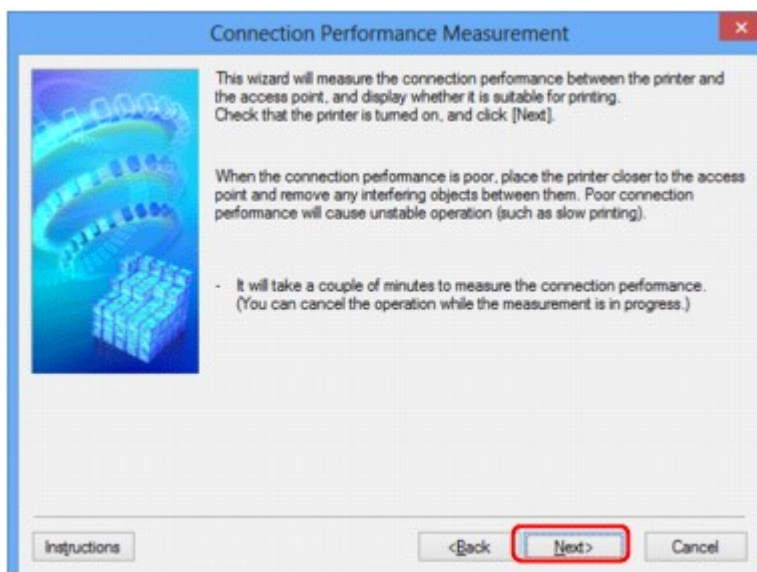

## 6. Check the status.

When the measurement is complete, the status is displayed.

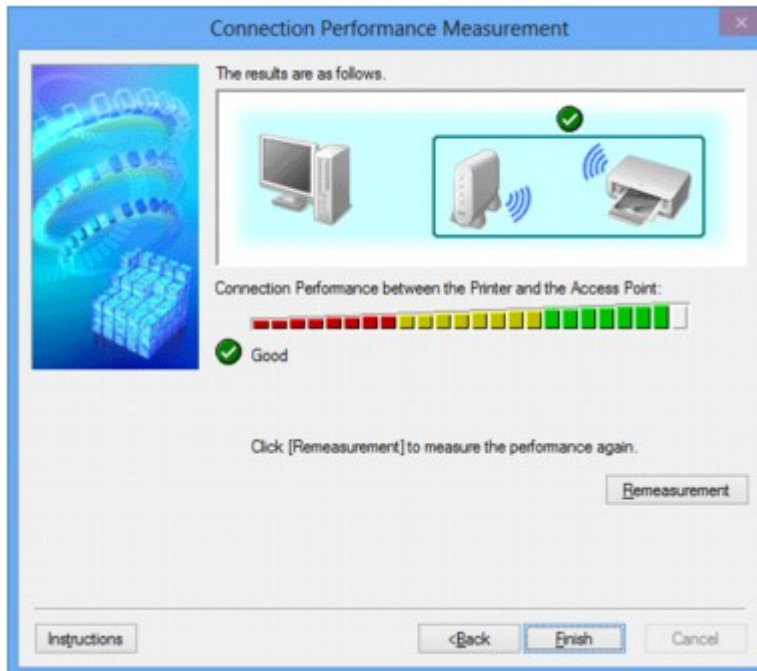

When  is displayed in **Connection Performance between the Printer and the Access Point:**, the printer can communicate with the access point. Otherwise, refer to displayed comments and the following to improve the status of communication link, and click **Remeasurement**.

- Check that the printer and the access point are located within the wireless connectivity range with no obstacles between them.
- Check if the distance between the printer and the access point is not too far.  
If they are too far, move them closer together (within 164 ft./50 m).
- Check that there is no barrier or obstacle between the printer and the access point.  
In general, connection performance decreases for communications through walls or between different floors. Adjust the locations to avoid such situations.
- Check that there are no sources of radio interference near the printer and the access point.  
The wireless connection may use the same frequency band as microwave ovens and other sources of radio interference. Try to keep the printer and the access point away from such sources.
- Check if the radio channel of the access point is close to that of other access points nearby.  
If the radio channel of the access point is close to that of other access points nearby, the connection performance may become unstable. Be sure to use a radio channel that does not interfere with other access points.
- Check that the printer and the access point face each other.  
Connection performance may depend on the orientations of the wireless devices. Replace the access point and the printer in another direction to achieve the best performance.
- Check whether other computers are not accessing the printer.

If  appears in the result of the measurement, check whether other computers are not accessing the printer.



If  still appears even if you have tried the above, finish the measurement, then restart the IJ Network Tool to start over the measurement.

7. Click **Finish**.

 **Note**

- If any messages appear on **Overall Network Performance:**, move the machine and access point as instructed to improve the performance.

# Initializing the Network Settings of the Machine

## ▶▶▶ Important

- Note that initialization erases all network settings on the machine, printing or scanning operation from a computer over network may become impossible. To use the machine over network, perform setup with the Setup CD-ROM or perform setup according to the instructions on our website.

1. [Start up IJ Network Tool.](#)
2. Select the printer in **Printers:**.
3. Select **Maintenance...** from the **Settings** menu.  
The **Maintenance** screen is displayed.
4. Click **Initialize.**

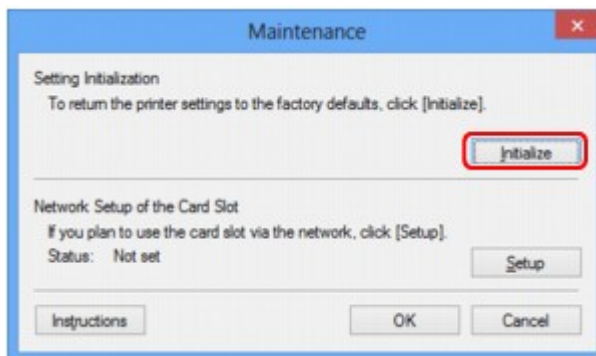

5. When the confirmation screen is displayed, click **Yes.**

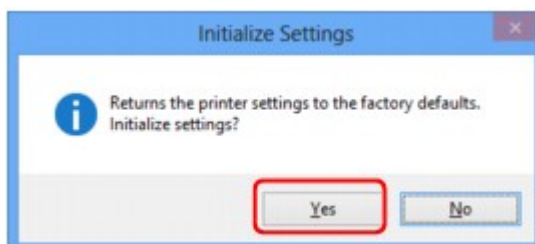

The network settings of the printer is initialized.

Do not turn off the printer during initialization.

Click **OK** when initialization is complete.

Performing initialization when connected over wireless LAN will break the connection, so perform setup with the Setup CD-ROM or perform setup according to the instructions on our website.

## ▶▶▶ Note

- You can change the network settings of the printer using IJ Network Tool with USB connection after initializing the LAN settings. To change the network settings using Canon IJ Network Tool, activate wireless LAN in advance.

## Viewing the Modified Settings

The **Confirmation** screen is displayed when you modified the printer settings on the **Configuration** screen. When you click **Yes** on the **Confirmation** screen, the following screen is displayed for confirming the modified settings.

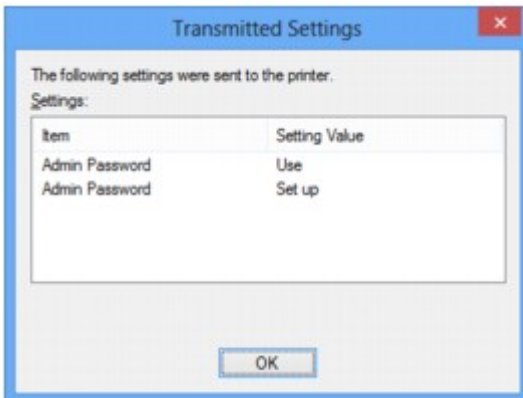

## Screens for Network Connection of IJ Network Tool

- ➔ [Canon IJ Network Tool Screen](#)
- ➔ [Configuration Screen](#)
- ➔ [Wireless LAN Sheet](#)
- ➔ [Search Screen](#)
- ➔ [WEP Details Screen](#)
- ➔ [WPA Details Screen](#)
- ➔ [WPA2 Details Screen](#)
- ➔ [Authentication Type Confirmation Screen](#)
- ➔ [PSK: Passphrase and Dynamic Encryption Setup Screen](#)
- ➔ [Setup Information Confirmation Screen](#)
- ➔ [Wired LAN Sheet](#)
- ➔ [Admin Password Sheet](#)
- ➔ [Network Information Screen](#)
- ➔ [Access Control Sheet](#)
- ➔ [Edit Accessible MAC Address Screen/Add Accessible MAC Address Screen](#)
- ➔ [Edit Accessible IP Address Screen/Add Accessible IP Address Screen](#)

# Canon IJ Network Tool Screen

This section describes the items and menus displayed on the **Canon IJ Network Tool** screen.

➔ [Items on the Canon IJ Network Tool Screen](#)

➔ [Canon IJ Network Tool Menus](#)

## Items on the Canon IJ Network Tool Screen

The following item is displayed on the **Canon IJ Network Tool** screen.

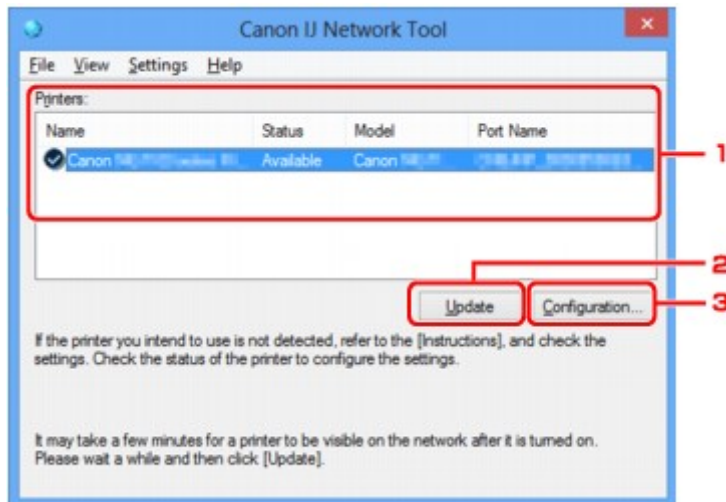

### 1. Printers:

The printer name, status, printer model name, and port name are displayed.

A check mark next to the printer in the **Name** list indicates it is set as the default printer.

Configuration changes are applied to the selected printer.

### 2. Update

Performs printer detection again. Click this button if the target printer is not displayed.

#### ▶▶▶ Important

- To change the printer's network settings using IJ Network Tool, it must be connected via a LAN.
- If **No Driver** is displayed for the name, associate the port with the printer.  
➔ [When the Printer Driver Is Not Associated with a Port](#)
- If **Not Found** is displayed for the status, check the followings:
  - The access point is turned on.
  - When using wired LAN, the LAN cable is connected properly.
- If the printer on a network is not detected, make sure that the printer is turned on, then click **Update**. It may take several minutes to detect printers. If the printer is not yet detected, connect the machine and the computer with a USB cable, then click **Update**.
- If the printer is being used from another computer, a screen is displayed informing you of this condition.

## ▶▶▶ Note

- This item has the same function as **Refresh** in the **View** menu.

### 3. Configuration...

Click to configure settings of the selected printer.

➔ [Configuration Screen](#)

## ▶▶▶ Note

- You cannot configure a printer that has the status **Not Found**.
- This item has the same function as **Configuration...** in the **Settings** menu.

## Canon IJ Network Tool Menus

The following menu is displayed from the **Canon IJ Network Tool** screen.

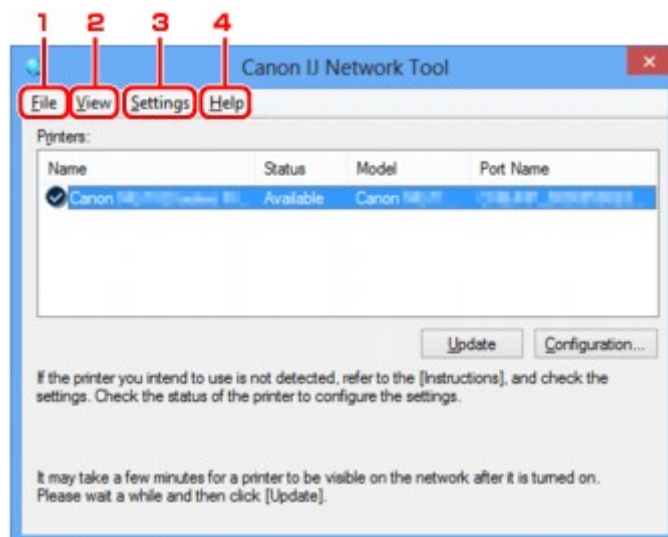

### 1. File menu

#### Exit

Exits IJ Network Tool.

### 2. View menu

#### Status

Displays the **Status** screen to confirm the printer connection status and wireless communication status.

➔ [Status Screen](#)

#### Refresh

Updates and displays the contents of **Printers:** on the **Canon IJ Network Tool** screen to the latest information.

## ▶▶▶ Important

- To change the printer's network settings using IJ Network Tool, it must be connected via a LAN.
- If **No Driver** is displayed for the name, associate the port with the printer.

➔ [When the Printer Driver Is Not Associated with a Port](#)

- If **Not Found** is displayed for the status, check the followings:
  - The access point is turned on.
  - When using wired LAN, the LAN cable is connected properly.
- If the printer on a network is not detected, make sure that the printer is turned on, then select **Refresh**. It may take several minutes to detect printers. If the printer is not yet detected, connect the machine and the computer with a USB cable, then select **Refresh**.
- If the printer is being used from another computer, a screen is displayed informing you of this condition.

### ▶▶▶ Note

- This item has the same function as **Update** in the **Canon IJ Network Tool** screen.

#### Network Information

Displays the **Network Information** screen to confirm the network settings of the printer and the computer.

➔ [Network Information Screen](#)

#### Display Warning Automatically

Enables or disables automatic display of the instruction screen.

When this menu is selected, the instruction screen is displayed if one or more ports are unavailable for printing.

### 3. Settings menu

#### Configuration...

Displays the **Configuration** screen to configure settings of the selected printer.

➔ [Configuration Screen](#)

### ▶▶▶ Note

- This item has the same function as **Configuration...** in the **Canon IJ Network Tool** screen.

#### Associate Port...

Displays the **Associate Port** screen and you can associate a port with the printer.

➔ [Associate Port Screen](#)

This menu is available when **No Driver** is displayed for the selected printer. Associating a port with the printer enables you to use it.

#### Maintenance...

Displays the **Maintenance** screen to revert the network settings of the printer to factory default and to mount the card slot as the network drive.

➔ [Maintenance Screen](#)

### 4. Help menu

#### Instructions

Displays this guide.

#### About

Displays the version of IJ Network Tool.

## Configuration Screen

You can change the configuration of the printer selected on the **Canon IJ Network Tool** screen.

Click the tab to select the sheet to change the settings.

The following screen is the example to change the setting on the **Wireless LAN** sheet.

### ▶▶▶ Note

- This screen is not available depending on the printer you are using.

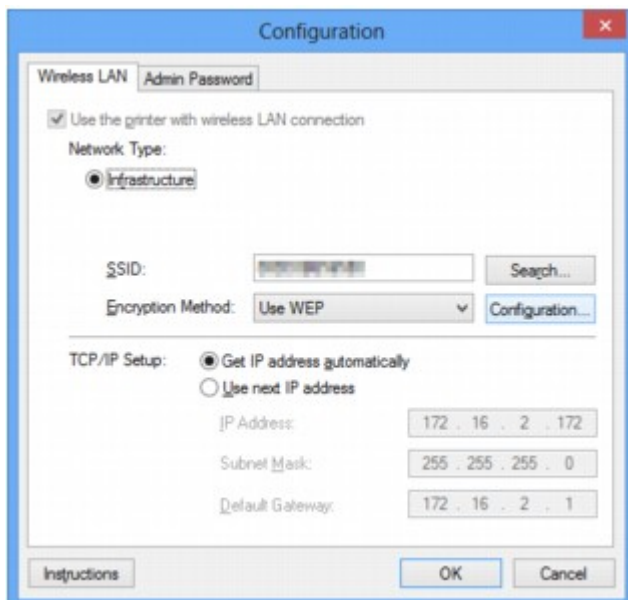

For details on each sheet, see the following.

➡ [Wireless LAN Sheet](#)

➡ [Wired LAN Sheet](#)

➡ [Admin Password Sheet](#)



# Wireless LAN Sheet

## ▶▶▶ Note

- This screen is not available depending on the printer you are using.

Allows you to set the printer with wireless LAN connection.

To display the **Wireless LAN** sheet, click the **Wireless LAN** tab on the **Configuration** screen.

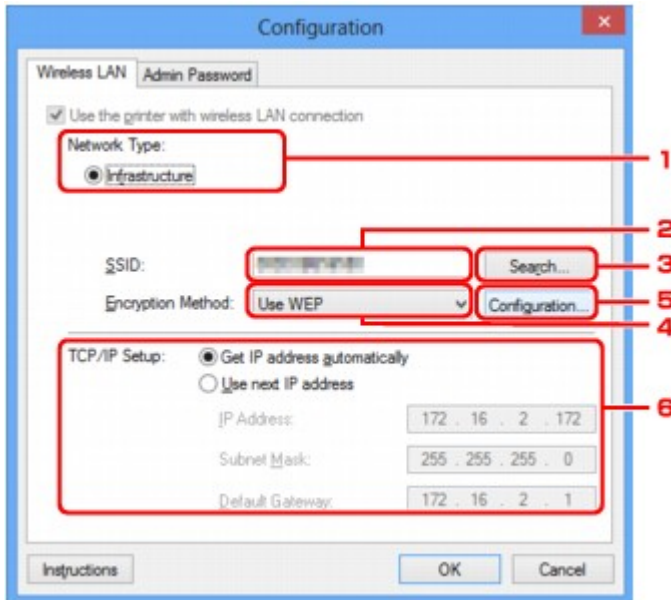

### 1. Network Type:

#### Infrastructure

Connects the printer to the wireless LAN with an access point.

### 2. SSID:

The SSID of the wireless LAN is displayed.

As the initial settings, the unique value is displayed.

## ▶▶▶ Note

- Enter the same SSID that the access point is configured to use. The SSID is case-sensitive.

### 3. Search...

The **Search** screen is displayed to select an access point to connect to.

➔ [Search Screen](#)

## ▶▶▶ Note

- When IJ Network Tool runs over a LAN, the button is grayed out and cannot be selected. Connect the printer and the computer with a USB cable temporarily to change the settings.

### 4. Encryption Method:

Select the encryption method used over the wireless LAN.

**Do not use**

Select to disable encryption.

**Use WEP**

Transmission is encrypted using a WEP key you specified.

If a WEP key has not been set, the **WEP Details** screen is displayed automatically. To change WEP settings set before, click **Configuration...** to display the screen.

➡ [Changing the WEP Detailed Settings](#)

**Use WPA/Use WPA2**

Transmission is encrypted using a WPA or WPA2 key you specified.

The security has been strengthened more than WEP.

If a WPA or WPA2 key has not been set, the **Authentication Type Confirmation** screen is displayed automatically. To change WPA or WPA2 settings set before, click **Configuration...** to display the **WPA Details** screen or **WPA2 Details** screen.

➡ [Changing the WPA or WPA2 Detailed Settings](#)

**5. Configuration...**

The detailed settings screen is displayed. The WEP, the WPA, or the WPA2 key selected in **Encryption Method:** can be confirmed and changed.

**For details on WEP setting:**

➡ [Changing the WEP Detailed Settings](#)

**For details on WPA or WPA2 setting:**

➡ [Changing the WPA or WPA2 Detailed Settings](#)

**6. TCP/IP Setup:**

Sets the IP address of the printer to be used over the LAN. Set a value appropriate for your network environment.

**Get IP address automatically**

Select this option to use an IP address automatically assigned by a DHCP server. DHCP server functionality must be enabled on your wireless LAN router or access point.

**Use next IP address**

If no DHCP server functionality is available in your setup where you use the printer or you want to use a particular IP address, select this option to use a fixed IP address.

# Search Screen

## ▶▶▶ Note

- This screen is not available depending on the printer you are using.

The access points detected are listed.

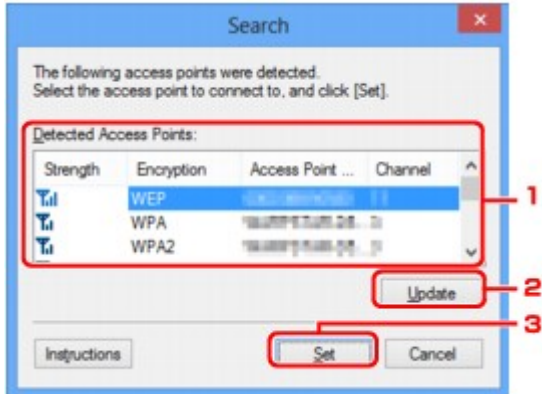

### 1. Detected Access Points:

The signal strength from the access point, encryption type, name of access point, and the radio channel can be confirmed.

## ▶▶▶ Important

- If you connect to a network that is not protected with security measures, there is a risk of disclosing data such as your personal information to a third party.

## ▶▶▶ Note

- Signal strength is displayed as follows.

Full : Good

Fair : Fair

Poor : Poor

- Type of encryption is displayed as follows.

Blank: No encryption

**WEP:** WEP is set

**WPA:** WPA is set

**WPA2:** WPA2 is set

### 2. Update

Click to update the list of access points when your target access point is not detected.

If the target access point is set to the stealth mode, click **Cancel** to return to the previous screen and enter the access point's SSID in **SSID:** on the **Wireless LAN** sheet.

➔ [Wireless LAN Sheet](#)

▶▶▶ **Note**

- When detecting your target access point, make sure that the access point is turned on.

### 3. **Set**

Click to set the access point's SSID in **SSID:** on the **Wireless LAN** sheet.

▶▶▶ **Note**

- The **WEP Details** screen, the **WPA Details** screen, or the **WPA2 Details** screen appears if the selected access point is encrypted. In this case, configure the details to use the same encryption settings set to the access point.
- Access points that cannot be used by this machine (including those configured to use different encryption methods) are displayed grayed out and cannot be configured.

# WEP Details Screen

## ►►► Note

- This screen is not available depending on the printer you are using.

Specify the printer WEP settings.

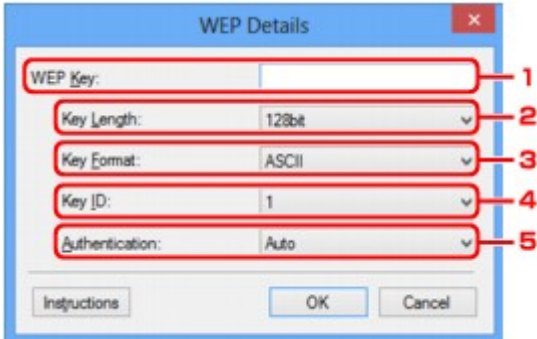

## ►►► Note

- When changing the password (WEP key) of the printer, the same change must be made to the password (WEP key) of the access point.

### 1. WEP Key:

Enter the same key as the one set to the access point.

The number of characters and character type that can be entered differ depending on the key length and key format.

		Key Length	
		64bit	128bit
Key Format	ASCII	5 characters	13 characters
	Hexadecimal (Hex)	10 digits	26 digits

### 2. Key Length:

Select either **64bit** or **128bit**.

### 3. Key Format:

Select either **ASCII** or **Hex**.

### 4. Key ID:

Select the Key ID (index) set to the access point.

### 5. Authentication:

Select the authentication method to authenticate the printer's access to the access point.

Select **Auto** or **Open System** or **Shared Key**.

# WPA Details Screen

## ▶▶▶ Note

- This screen is not available depending on the printer you are using.

Specify the printer WPA settings.

The value displayed on the screen differs depending on the present settings.

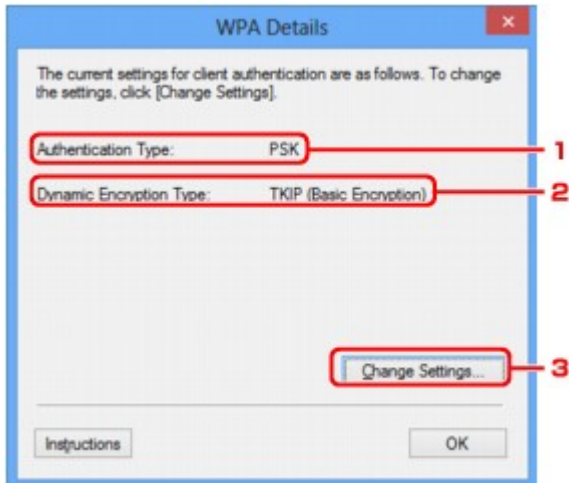

### 1. Authentication Type:

Displays the type of authentication used for client authentication. This machine supports the PSK authentication method.

### 2. Dynamic Encryption Type:

Displays the dynamic encryption method.

### 3. Change Settings...

Displays the **Authentication Type Confirmation** screen.

➡ [Authentication Type Confirmation Screen](#)

# WPA2 Details Screen

## ▶▶▶ Note

- This screen is not available depending on the printer you are using.

Specify the printer WPA2 settings.

The value displayed on the screen differs depending on the present settings.

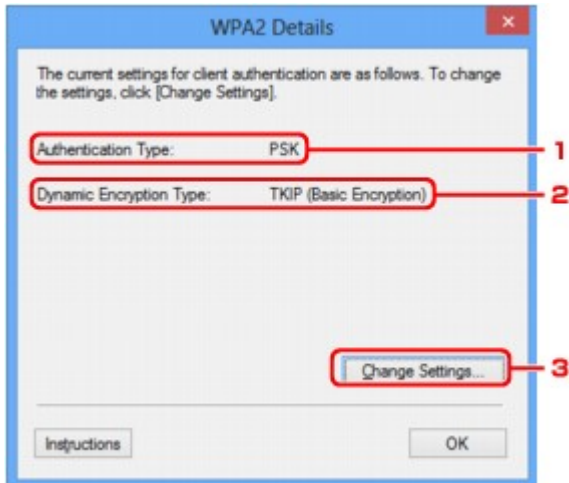

### 1. Authentication Type:

Displays the type of authentication used for client authentication. This machine supports the PSK authentication method.

### 2. Dynamic Encryption Type:

Displays the dynamic encryption method.

### 3. Change Settings...

Displays the **Authentication Type Confirmation** screen.

➡ [Authentication Type Confirmation Screen](#)

# Authentication Type Confirmation Screen

## ►►► Note

- This screen is not available depending on the printer you are using.

Type of authentication used for client authentication is displayed.

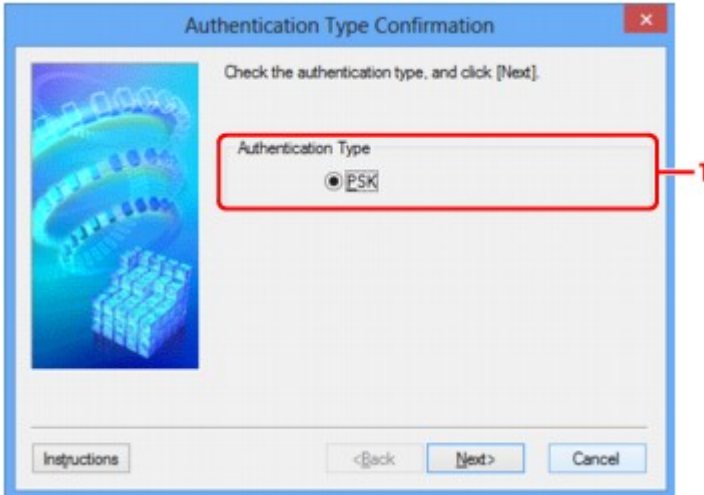

### 1. Authentication Type

Type of authentication used for client authentication is displayed.

#### PSK

This machine supports the **PSK** authentication method.

This authentication type **PSK** uses a passphrase.



# PSK: Passphrase and Dynamic Encryption Setup Screen

## ▶▶▶ Note

- This screen is not available depending on the printer you are using.

Enter the passphrase and select the dynamic encryption method.

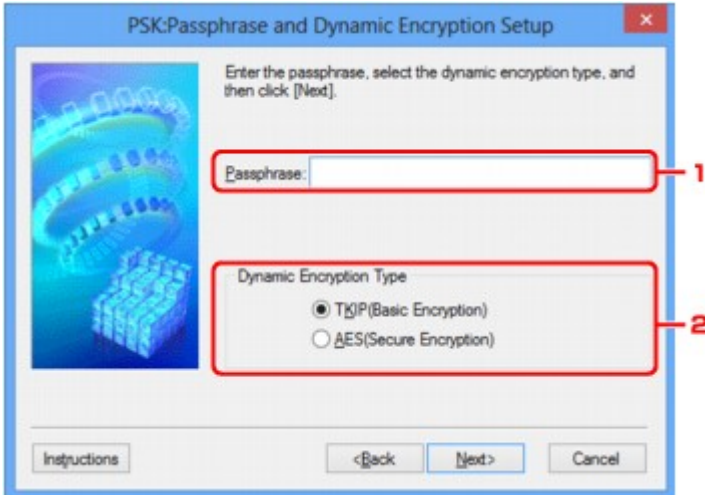

### 1. Passphrase:

Enter the passphrase set to the access point. The passphrase should be a string of 8 to 63 alphanumeric characters or a 64-digit hexadecimal value.

If you do not know the access point passphrase, refer to the instruction manual provided with the access point or contact its manufacturer.

### 2. Dynamic Encryption Type

Select the dynamic encryption method from either **TKIP (Basic Encryption)**, or **AES (Secure Encryption)** according to the setting of the access point.

## Setup Information Confirmation Screen

### ▶▶▶ Note

- This screen is not available depending on the printer you are using.

Displays the settings used for client authentication.

Confirm the settings and click **Finish**.

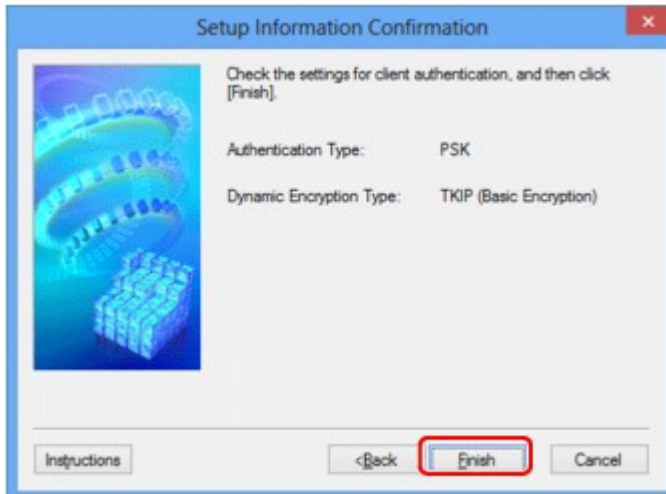

# Wired LAN Sheet

## ▶▶▶ Note

- This screen is not available depending on the printer you are using.

Allows you to set the printer with wired LAN connection.

To display the **Wired LAN** sheet, click the **Wired LAN** tab on the **Configuration** screen.

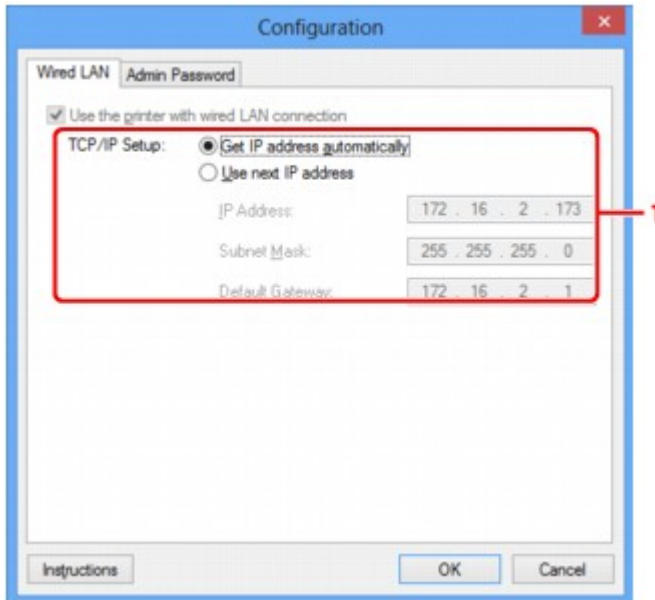

### 1. TCP/IP Setup:

Sets the IP address of the printer to be used over the LAN. Set a value appropriate for your network environment.

#### **Get IP address automatically**

Select this option to use an IP address automatically assigned by a DHCP server. DHCP server functionality must be enabled on your router.

#### **Use next IP address**

If no DHCP server functionality is available in your setup where you use the printer or you want to use a particular IP address, select this option to use a fixed IP address.

# Admin Password Sheet

Set a password for the printer to allow specific people to perform setup and configurations operation.

To display the **Admin Password** sheet, click the **Admin Password** tab on the **Configuration** screen.

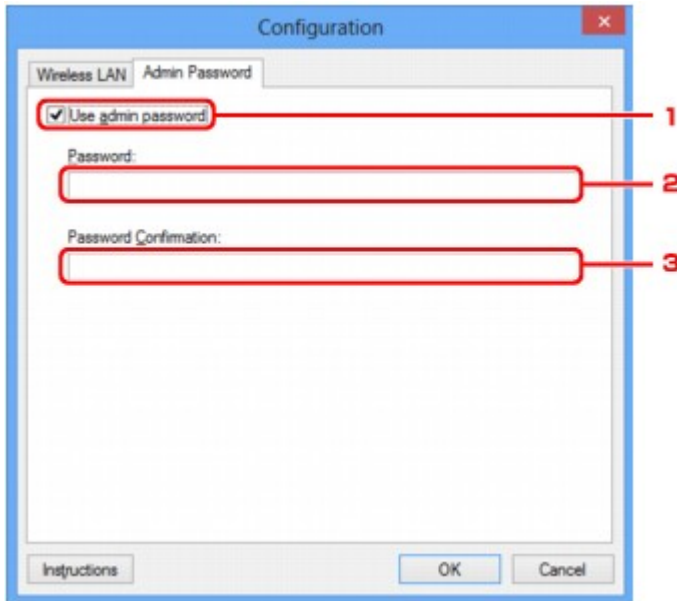

## 1. Use admin password

Set a password for the administrator with privileges to set up and change detailed options. To use this feature, select this check box and enter a password.

## 2. Password:

Enter the password to set.

## 3. Password Confirmation:

Enter the password again for confirmation.

# Network Information Screen

Display the network information that is set for the printers and the computers.

To display the **Network Information** screen, select **Network Information** from the **View** menu.

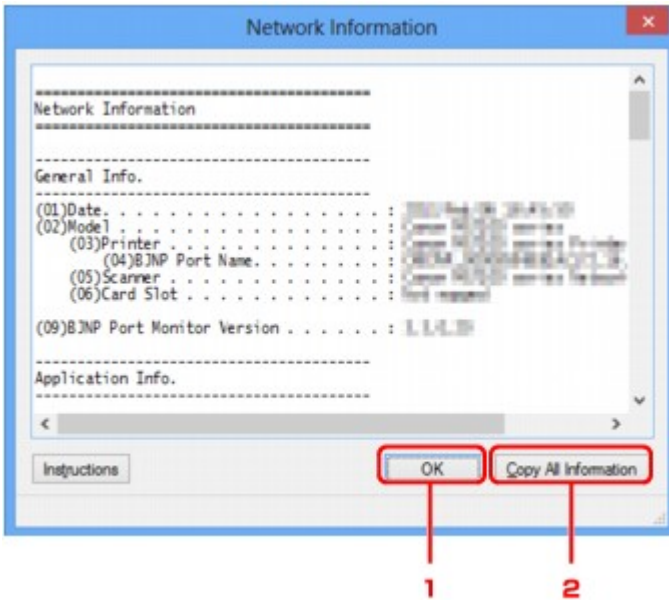

## 1. OK

Returns to the **Canon IJ Network Tool** screen.

## 2. Copy All Information

All network information displayed is copy to the clipboard.

# Access Control Sheet

## ▶▶▶ Note

- This screen is not available depending on the printer you are using.

You can register the MAC addresses or the IP addresses of computers or network devices to allow access. To display the **Access Control** sheet, click the **Access Control** tab on the **Configuration** screen.

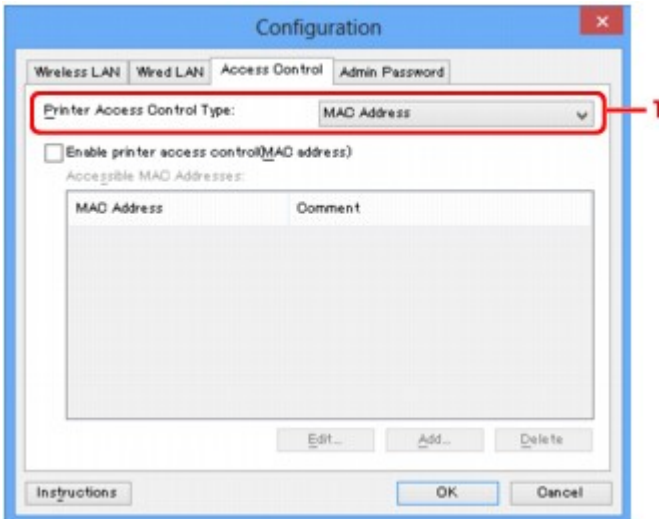

### 1. Printer Access Control Type:

Select the type of access control with which to limit access of computers or network devices to the printer over a network.

The setting items may differ depending on the choice of access control methods.

➔ [When Selecting MAC address](#)

➔ [When Selecting IP address](#)

### When Selecting MAC address

The accessible computers or network devices are specified by their MAC addresses. Computers or network devices whose MAC addresses appear on the list are allowed access.

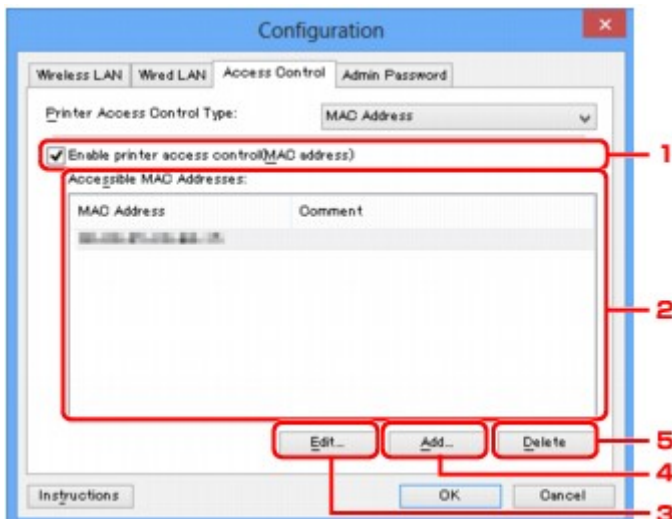

## 1. Enable printer access control(MAC address)

Select to enable access control to the printer by MAC address.

### »» Note

- The two types of access control (i.e., by MAC address and by IP address) can be enabled at the same time.

An access control type is enabled as long as the **Enable printer access control** check box is selected, regardless of the type currently displayed by selecting in **Printer Access Control Type**:

- When both access control types are enabled at the same time, a computer or a network device whose address is registered to either list will be allowed access to the printer.

## 2. Accessible MAC Addresses:

Shows the registered MAC addresses and any comments.

## 3. Edit...

The **Edit Accessible MAC Address** screen is displayed to edit the settings selected in **Accessible MAC Addresses**:

➔ [Edit Accessible MAC Address Screen/Add Accessible MAC Address Screen](#)

## 4. Add...

The **Add Accessible MAC Address** screen is displayed to register the MAC address of a computer or a network device from which to access the printer over the network.

### »» Important

- Add the MAC address of all computers or network devices within the network from which to access the printer. The printer cannot be accessed from a computer or a network device that is not on the list.

## 5. Delete

Deletes the selected MAC address from the list.

## When Selecting IP address

The accessible computers or network devices are specified by their IP addresses. Computers or network devices whose IP addresses appear on the list are allowed access.

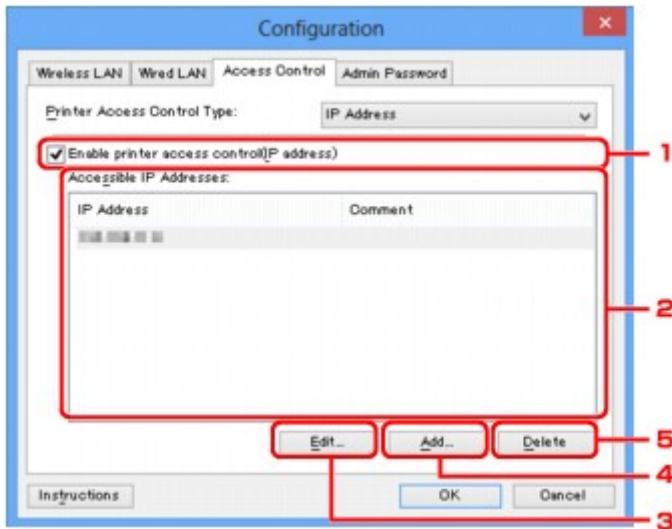

### 1. Enable printer access control(IP address)

Select to enable access control to the printer by IP address.

#### »»» Note

- The two types of access control (i.e., by MAC address and by IP address) can be enabled at the same time.
- An access control type is enabled as long as the **Enable printer access control** check box is selected, regardless of the type currently displayed by selecting in **Printer Access Control Type**.
- When both access control types are enabled at the same time, a computer or a network device whose address is registered to either list will be allowed access to the printer.

### 2. Accessible IP Addresses:

Shows the registered IP addresses and any comments.

### 3. Edit...

The **Edit Accessible IP Address** screen is displayed to edit the settings selected in **Accessible IP Addresses**.

➔ [Edit Accessible IP Address Screen/Add Accessible IP Address Screen](#)

### 4. Add...

The **Add Accessible IP Address** screen is displayed to register the IP address of a computer or a network device from which to access the printer over the network.

#### »»» Important

- Add the IP address of all computers or network devices within the network from which to access the printer. The printer cannot be accessed from a computer or a network device that is not on the list.
- Up to 16 IP addresses can be registered. IP addresses specified by Range Specification are counted as one address. Use Range Specification when you intend to register 17 or more IP addresses.



## 5. Delete

Deletes the selected IP address from the list.

# Edit Accessible MAC Address Screen/Add Accessible MAC Address Screen

## ▶▶▶ Note

- This screen is not available depending on the printer you are using.

The example screenshots in this section refer to the **Add Accessible MAC Address** Screen.



### 1. **MAC Address:**

Enter the MAC address of a computer or a network device to allow access.

### 2. **Comment:**

Optionally enter any information to identify the device, such as the name of the computer.

## ▶▶▶ Important

- Comments will be displayed only on the computer used to enter them.

# Edit Accessible IP Address Screen/Add Accessible IP Address Screen

## »» Note

- This screen is not available depending on the printer you are using.

The example screenshots in this section refer to the **Add Accessible IP Address** Screen.



### 1. Specification Method:

Select either **Single Address Specification** or **Range Specification** to add the IP address(es).

#### Single Address Specification

Specify each IP address separately.

#### Range Specification

Specify a range of successive IP addresses.

### 2. IP Address:

Enter the IP address of a computer or a network device to allow access when you selected **Single Address Specification** in **Specification Method**:

An IP address is expressed as four values ranging from 0 to 255.

#### Start IP Address:

Enter the first IP address in the range of addresses of the computers or network devices to allow access when you selected **Range Specification** in **Specification Method**:

An IP address is expressed as four values ranging from 0 to 255.

#### End IP Address:

Enter the last IP address in the range of addresses of the computers or network devices to allow access when you selected **Range Specification** in **Specification Method**:

An IP address is expressed as four values ranging from 0 to 255.

## »» Note

- The **Start IP Address**: must be a smaller value than the **End IP Address**:

### 3. Comment:

Optionally enter any information to identify the device, such as the name of the computer.

## »» Important

- Comments will be displayed only on the computer used to enter them.

## Other Screens of IJ Network Tool

- ➔ [Canon IJ Network Tool Screen](#)
- ➔ [Status Screen](#)
- ➔ [Connection Performance Measurement Screen](#)
- ➔ [Maintenance Screen](#)
- ➔ [Network Setup of the Card Slot Screen](#)
- ➔ [Associate Port Screen](#)
- ➔ [Network Information Screen](#)

# Canon IJ Network Tool Screen

This section describes the items and menus displayed on the **Canon IJ Network Tool** screen.

➔ [Items on the Canon IJ Network Tool Screen](#)

➔ [Canon IJ Network Tool Menus](#)

## Items on the Canon IJ Network Tool Screen

The following item is displayed on the **Canon IJ Network Tool** screen.

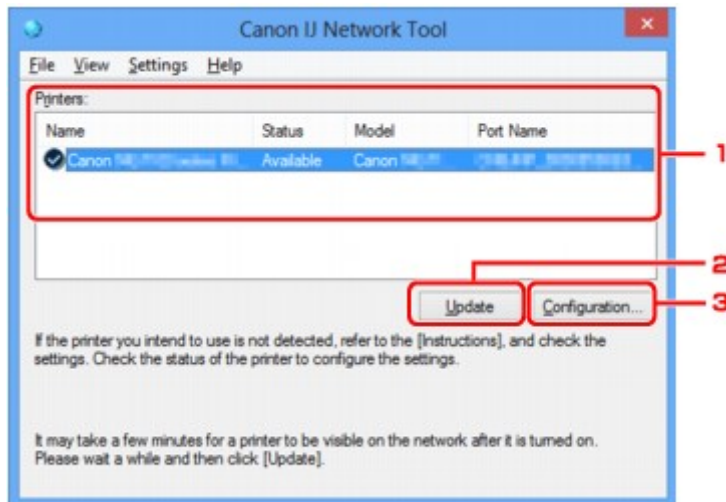

### 1. Printers:

The printer name, status, printer model name, and port name are displayed.

A check mark next to the printer in the **Name** list indicates it is set as the default printer.

Configuration changes are applied to the selected printer.

### 2. Update

Performs printer detection again. Click this button if the target printer is not displayed.

#### ▶▶▶ Important

- To change the printer's network settings using IJ Network Tool, it must be connected via a LAN.
- If **No Driver** is displayed for the name, associate the port with the printer.  
➔ [When the Printer Driver Is Not Associated with a Port](#)
- If **Not Found** is displayed for the status, check the followings:
  - The access point is turned on.
  - When using wired LAN, the LAN cable is connected properly.
- If the printer on a network is not detected, make sure that the printer is turned on, then click **Update**. It may take several minutes to detect printers. If the printer is not yet detected, connect the machine and the computer with a USB cable, then click **Update**.
- If the printer is being used from another computer, a screen is displayed informing you of this condition.

## ▶▶▶ Note

- This item has the same function as **Refresh** in the **View** menu.

### 3. Configuration...

Click to configure settings of the selected printer.

➔ [Configuration Screen](#)

## ▶▶▶ Note

- You cannot configure a printer that has the status **Not Found**.
- This item has the same function as **Configuration...** in the **Settings** menu.

## Canon IJ Network Tool Menus

The following menu is displayed from the **Canon IJ Network Tool** screen.

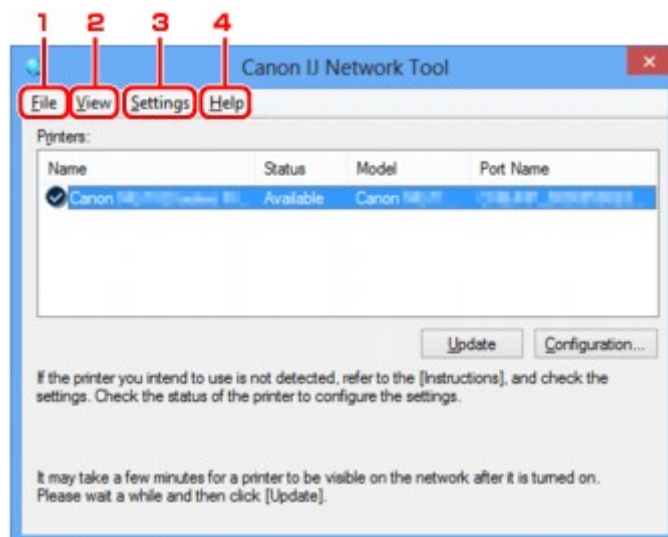

### 1. File menu

#### Exit

Exits IJ Network Tool.

### 2. View menu

#### Status

Displays the **Status** screen to confirm the printer connection status and wireless communication status.

➔ [Status Screen](#)

#### Refresh

Updates and displays the contents of **Printers:** on the **Canon IJ Network Tool** screen to the latest information.

## ▶▶▶ Important

- To change the printer's network settings using IJ Network Tool, it must be connected via a LAN.
- If **No Driver** is displayed for the name, associate the port with the printer.

➔ [When the Printer Driver Is Not Associated with a Port](#)

- If **Not Found** is displayed for the status, check the followings:
  - The access point is turned on.
  - When using wired LAN, the LAN cable is connected properly.
- If the printer on a network is not detected, make sure that the printer is turned on, then select **Refresh**. It may take several minutes to detect printers. If the printer is not yet detected, connect the machine and the computer with a USB cable, then select **Refresh**.
- If the printer is being used from another computer, a screen is displayed informing you of this condition.

### ▶▶▶ Note

- This item has the same function as **Update** in the **Canon IJ Network Tool** screen.

#### Network Information

Displays the **Network Information** screen to confirm the network settings of the printer and the computer.

➔ [Network Information Screen](#)

#### Display Warning Automatically

Enables or disables automatic display of the instruction screen.

When this menu is selected, the instruction screen is displayed if one or more ports are unavailable for printing.

### 3. Settings menu

#### Configuration...

Displays the **Configuration** screen to configure settings of the selected printer.

➔ [Configuration Screen](#)

### ▶▶▶ Note

- This item has the same function as **Configuration...** in the **Canon IJ Network Tool** screen.

#### Associate Port...

Displays the **Associate Port** screen and you can associate a port with the printer.

➔ [Associate Port Screen](#)

This menu is available when **No Driver** is displayed for the selected printer. Associating a port with the printer enables you to use it.

#### Maintenance...

Displays the **Maintenance** screen to revert the network settings of the printer to factory default and to mount the card slot as the network drive.

➔ [Maintenance Screen](#)

### 4. Help menu

#### Instructions

Displays this guide.

#### About

Displays the version of IJ Network Tool.

# Status Screen

You can check the printer status and connection performance.

To display the **Status** screen, select **Status** from the **View** menu.

## »» Note

- This screen is not available depending on the printer you are using.
- When using wired LAN, **Signal Strength:**, **Link Quality:** and **Advanced Measurement...** are not available.

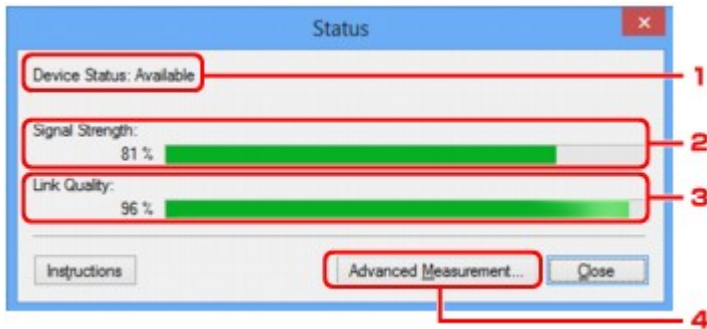

### 1. Device Status:

The device status is displayed as **Available** or **Unavailable**.

### 2. Signal Strength:

Indicates the strength of the signal received by the printer, ranging from 0% to 100%.

### 3. Link Quality:

Indicates the signal quality excluding the noise while communicating, ranging from 0% to 100%.

### 4. Advanced Measurement...

To examine the connection performance between the printer and the access point or between the printer and the computer.

When you click, the **Connection Performance Measurement** is displayed.

➡ [Connection Performance Measurement Screen](#)



# Connection Performance Measurement Screen

## ▶▶▶ Note

- This screen is not available depending on the printer you are using.

Displays to execute the connection performance measurement.

➔ [Connection Performance Measurement Screen \(Initial Screen\)](#)

➔ [Connection Performance Measurement Screen \(Completion Screen\)](#)

## Connection Performance Measurement Screen (Initial Screen)

Click **Next>** to start measurement.

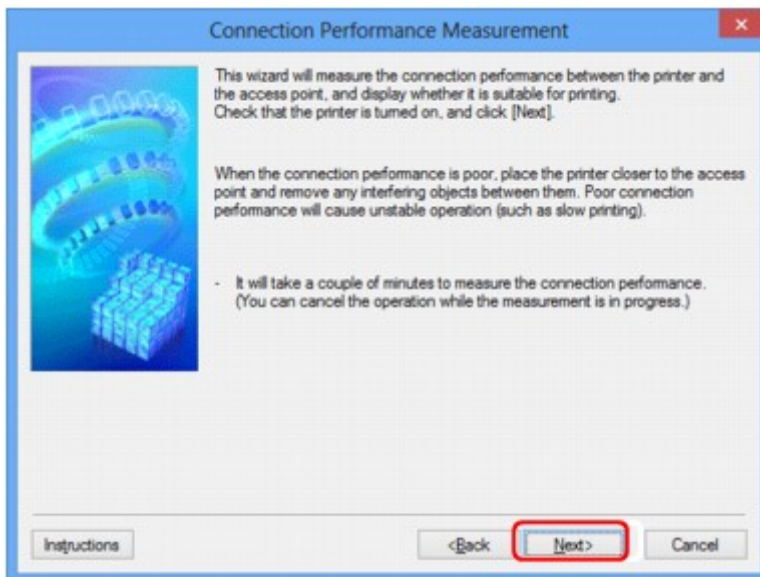

## Connection Performance Measurement Screen (Completion Screen)

Displays when the measurement is finished.

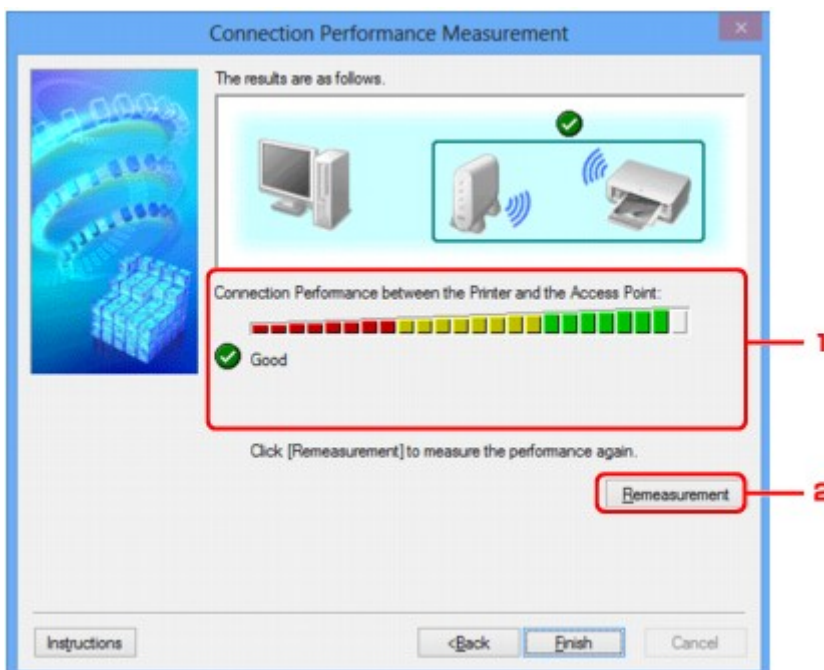

## 1. Connection Performance between the Printer and the Access Point:

A mark indicates the result of the connection performance measurement between the printer and the access point.



: Good connection performance



: Unstable connection performance



: Cannot connect



: Measurement is canceled, or cannot measure

## 2. Remeasurement

Measures the connection performance again.

### ▶▶ Note

- If any messages appear on **Overall Network Performance**:, move the machine and access point as instructed to improve the performance.

# Maintenance Screen

Displays to perform **Setting Initialization** and **Network Setup of the Card Slot**.

To display the **Maintenance** screen, select **Maintenance...** from the **Settings** menu.

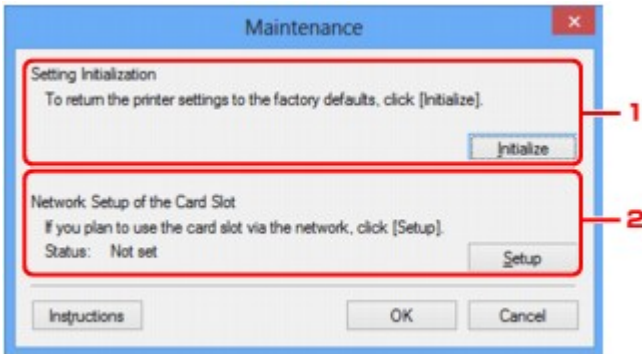

## 1. Setting Initialization

Reverts all the network settings of the printer to factory default. Click **Initialize** to display the **Initialize Settings** screen and click **Yes** to initialize the network settings of the printer. Do not turn off the printer during initialization. Click **OK** when initialization is complete.

Performing initialization when connected over wireless LAN will break the connection, so perform setup with the Setup CD-ROM or perform setup according to the instructions on our website.

## 2. Network Setup of the Card Slot

### ►►► Note

- This item is not available depending on the printer you are using.

**Status** displays whether the card slot is mapped as a network drive.

When you click, the **Network Setup of the Card Slot** is displayed.

➔ [Network Setup of the Card Slot Screen](#)

## Network Setup of the Card Slot Screen

### ▶▶▶ Note

- This screen is not available depending on the printer you are using.

Displays settings of the card slot and allows you to map a card slot on the network as a network drive on the computer.

Displays when you click **Setup** on the **Maintenance** screen.

➔ [Network Setup of the Card Slot Screen \(Setup Screen\)](#)

➔ [Network Setup of the Card Slot Screen \(Setup Failed Screen\)](#)

### ▶▶▶ Note

- You can change the network settings of the printer using IJ Network Tool with USB connection after initializing the LAN settings. To change the network settings using IJ Network Tool, activate the LAN settings in advance.

## Network Setup of the Card Slot Screen (Setup Screen)

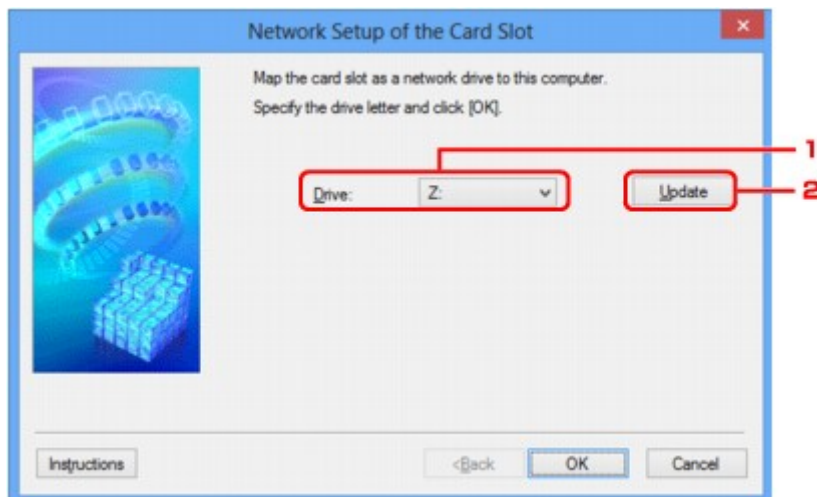

### 1. Drive:

Select the drive letter to assign to the network drive.

### 2. Update

Reloads the drive letters that are unassigned in **Computer (My Computer in Windows XP)** and displays them in the **Drive:** list.

## Network Setup of the Card Slot Screen (Setup Failed Screen)

Display when the network setup of the card slot is failed.

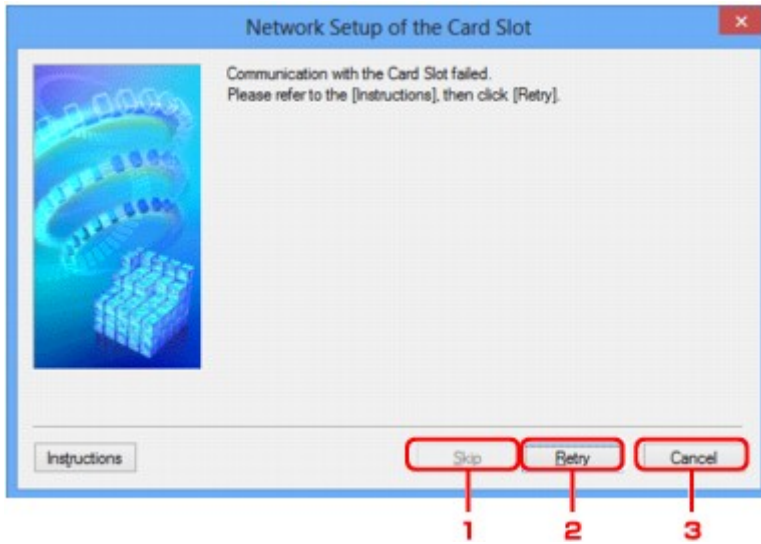

### 1. **Skip**

Completes the setup without mapping a network drive to the card slot.

### 2. **Retry**

Returns to **Network Setup of the Card Slot** screen and re-executes the network drive mapping.

### 3. **Cancel**

Cancels the card slot setup. When IJ Network Tool is running over LAN, the **Cancel** button is displayed grayed out and cannot be clicked.

# Associate Port Screen

Allows you to associate a created port with a printer driver.

Select the printer for which you want to change the association, then click **OK**.

## ▶▶▶ Note

- You cannot print with the printer unless the printer driver is associated with the port.

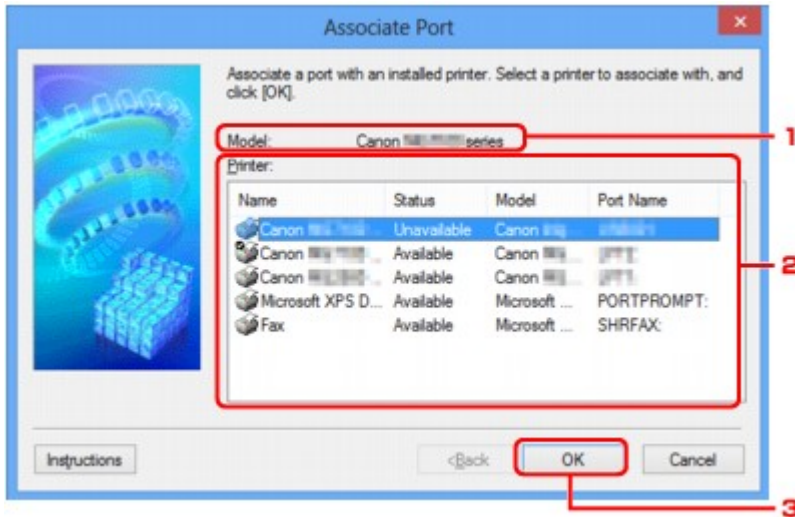

### 1. **Model:**

Displays the name of device specified as a destination port.

It is blank if the name of device is not detected.

### 2. **Printer:**

Displays the printer driver installed in the computer.

Select the printer for which you want to change the association.

### 3. **OK**

Performs association.

# Network Information Screen

Display the network information that is set for the printers and the computers.

To display the **Network Information** screen, select **Network Information** from the **View** menu.

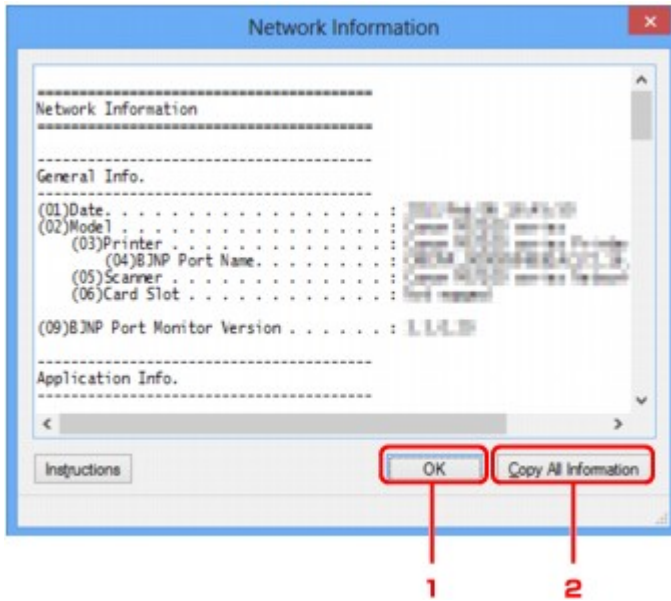

## 1. OK

Returns to the **Canon IJ Network Tool** screen.

## 2. Copy All Information

All network information displayed is copy to the clipboard.

## Appendix for Network Communication

- ➔ [Using the Card Slot over a Network](#)
- ➔ [When the Printer Driver Is Not Associated with a Port](#)
- ➔ [About Technical Terms](#)
- ➔ [Restrictions](#)
- ➔ [About Firewall](#)



# Using the Card Slot over a Network

## ▶▶▶ Note

- This screen is not available depending on the printer you are using.

- ➔ [Mounting the Card Slot as the Network Drive](#)
- ➔ [Restrictions on Card Slot Use over a Network](#)

## Mounting the Card Slot as the Network Drive

The card slot must be mounted to use it over a network.

To mount the card slot as the network drive, follow the procedure below.

1. Insert a memory card into the card slot of the machine.
2. [Start up IJ Network Tool.](#)
3. Select the machine in **Printers:**.
4. Select **Maintenance...** on the **Settings** menu.
5. Click **Setup**.

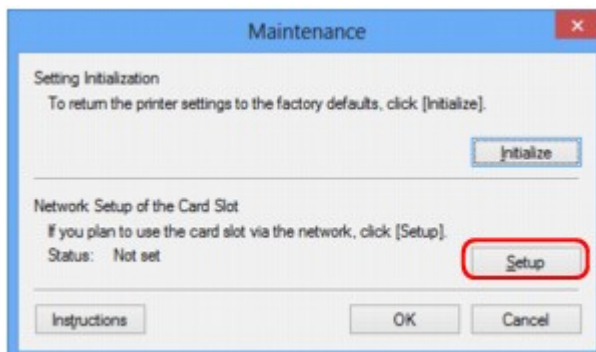

6. Specify the drive letter, then click **OK**.

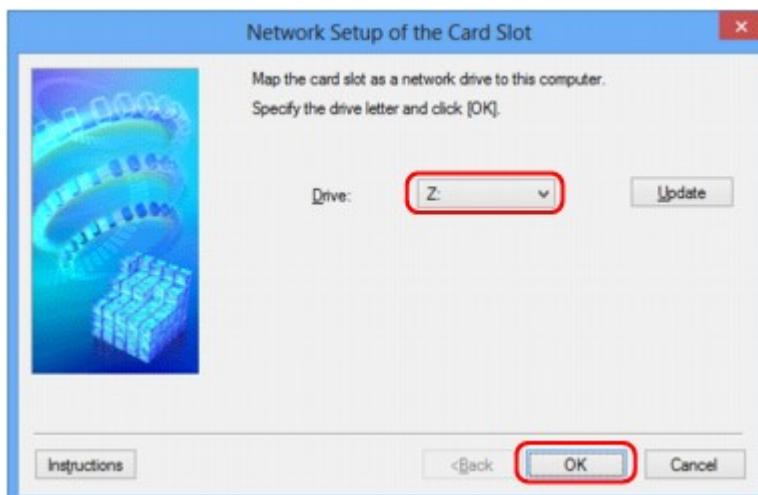

## 7. Make sure that the card slot is mounted.

When the card slot is mounted, the following icon appears on **Computer** (or **My Computer**).

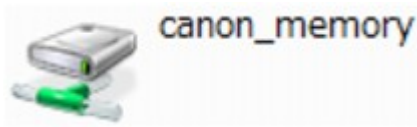

## Restrictions on Card Slot Use over a Network

- The card slot can be shared by multiple computers, if the machine is connected to a network. Multiple computers can read files from a memory card in the card slot at the same time. However, while one computer is writing a file into a memory card, other computers cannot access the same file.
- If your computer joins a domain, the card slot may not be mounted as the network drive.
- If you use the memory card stored the large size files or many files, a large amount of card access may be generated. In this case, the operation in the memory card may be impossible or slow. Operate after the **Access** lamp of the machine is lit.

- When you access the network drive for the card slot over the network, file names consisting of eight or less lowercase letters (not including its extension) may be shown in uppercase.

For example, a file name such as "abcdefg.doc" will be "ABCDEFGG.DOC", while a name such as "AbcdeFG.doc" will appear the same.

The file is not actually renamed, but merely appears to be changed.

- When you enable a memory card in the card slot of the machine to be writable only from a USB-connected computer, you cannot access the network drive of the card slot. On the other hand, when you enable it to be writable only from a LAN-connected computer, the card slot is not detected via USB. Make sure that the card slot setting is selected properly according to your connection method.

To read files from a memory card via USB and over a network, disable the function to write files to a memory card from a computer. You cannot write files to a memory card in either way with this setting.

- When you enable a memory card in the card slot of the machine to be writable only from a LAN-connected computer, you can write files to a memory card from a computer connected to a network. Note that it may increase the risk that the data on the memory card is infected by computer viruses or accessed illegally.

It is recommended to use the access control function of the machine or connect to the Internet via a router. For information on using a router, contact your Internet service provider or a network device manufacturer.

- If you write files to a memory card over a network when IJ Network Scanner Selector EX is not running, the Date Modified of the files may not be proper. Make sure to start up IJ Network Scanner Selector EX before you write files to a memory card over the network. For details, refer to "IJ Network Scanner Selector EX Menu and Setting Screen" from the HOME of your product's *Online Manual*.

## When the Printer Driver Is Not Associated with a Port

If **No Driver** is displayed for the printer's name on the **Canon IJ Network Tool** screen, the printer driver is not associated with a created port.

To associate a port with a printer driver, follow the procedure below.

1. [Start up IJ Network Tool.](#)
2. Select the printer displayed as **No Driver** on **Name**.
3. Select **Associate Port...** on the **Settings** menu.

The **Associate Port** screen is displayed.

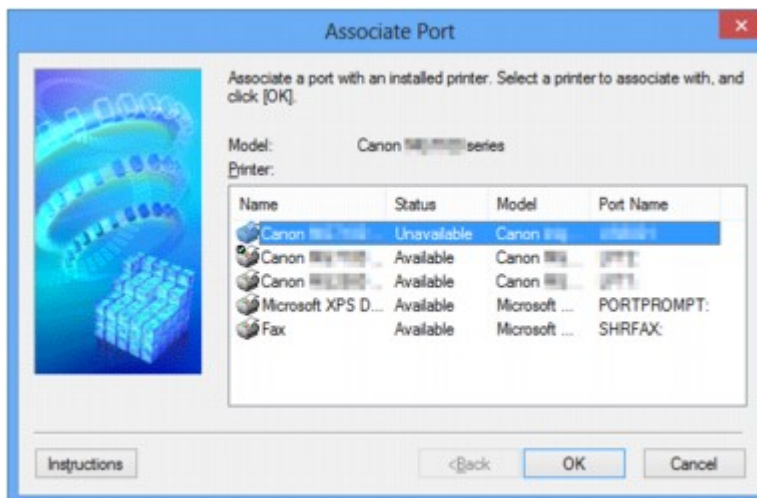

4. Select a printer to associate with a port.

The list of the printers that the printer driver is installed is displayed at **Printer:** on the **Associate Port** screen. Select a printer to associate with a created port.

5. Click **OK**.

# About Technical Terms

In this section, technical terms used in the manual are explained.

➡ [A](#)

➡ [B](#)

➡ [C](#)

➡ [D](#)

➡ [E](#)

➡ [I](#)

➡ [K](#)

➡ [L](#)

➡ [M](#)

➡ [O](#)

➡ [P](#)

➡ [R](#)

➡ [S](#)

➡ [T](#)

➡ [U](#)

➡ [W](#)

## A

- **Access Point**

A wireless transceiver or base station that receives information from wireless clients/the machine and rebroadcasts it. Required in an infrastructure network.

- **Ad-hoc**

Client computer and machine setting where wireless communication occurs on a peer-to-peer basis, i.e., all clients in with the same SSID/network name communicate directly with each other. No access point is required. This machine does not support ad-hoc communication.

- **Admin Password**

Administration password in IJ Network Tool to restrict access to network users. It must be entered to access the printer and change printer settings.

When the printer's network settings are factory default, the admin password does not have to be entered.

- **AES**

An encryption method. It is optional for WPA. Strong cryptographic algorithm adopted within U.S. government organizations for information processing.

- **Authentication Method**

The method that an access point uses to authenticate a printer through a wireless LAN. The methods are agreeable each other.

When using WEP as an encryption method, the authentication method is able to fix to **Open System** or **Shared Key**.

For WPA/WPA2, authentication method is PSK.

- **Auto**

The printer automatically changes its authentication method to match the access point.

- **Open System**

In this authentication method, the communication partner is authenticated without using WEP key even if **Use WEP** is selected.

- **Shared Key**

In this authentication method, the communication partner is authenticated using the WEP key that was set for encryption.

## **B**

- **Bonjour**

A service built into Mac OS X operating system to detect the connectable devices on a network automatically.

## **C**

- **Channel**

Frequency channel for wireless communication. In the infrastructure mode, the channel is automatically adjusted to match that set to the access point. This machine supports channels 1 to 13. Note that the number of channels that can be used for your wireless LAN varies depending on the region or country.

## **D**

- **Default Gateway**

A relay device to connect to another network such as a router or a computer.

- **DHCP server functionality**

The router or the access point assigns an IP address automatically whenever the printer or the personal computer on a network starts up.

- **DNS server**

A server that converts device names into IP addresses. When specifying IP addresses manually, specify the addresses of both a primary and a secondary server.

## **F**

- **Firewall**

It is a system that prevents an unlawful computer access in the network. To prevent, you can use the firewall function of a broadband router, the security software installed in the computer, or operation system for computer.

## I

- **IEEE 802.11b**

International standard for wireless LAN using the 2.4 GHz frequency range with a throughput of up to 11 Mbps.

- **IEEE 802.11g**

International standard for wireless LAN using the 2.4 GHz frequency range with a throughput of up to 54 Mbps. Compatible with 802.11b.

- **IEEE 802.11n**

International standard for wireless LAN using the 2.4 GHz and 5 GHz frequency ranges. Even when using two or more antennas simultaneously or obtaining a bigger transfer rate than before by using multiple communication channels at the same time, the transmission speed may be influenced by the connected apparatus.

At the maximum transfer rate of 600 Mbps, it is possible to communicate with multiple computer terminals within a dozen or so metre radius.

Compatible with 802.11b and 802.11g.

- **Infrastructure**

Client computer and machine setup where all wireless communications pass through an access point.

- **IP Address**

A unique number with four parts separated by dots. Every network device that is connected to the Internet has an IP address. Example: 192.168.0.1

An IP address is usually assigned by an access point or a DHCP server of the router automatically.

- **IPv4/IPv6**

They are internetwork-layer protocol used on the internet. IPv4 uses 32-bit addresses and IPv6 uses 128-bit addresses.

## K

- **Key Format**

Select either **ASCII** or **Hex** as the WEP key format. The character that can be used for the WEP key differs depending on the selected key formats.

- ASCII

Specify with a 5 or 13-character string that can include alphanumeric and underscore "\_" characters. It is case-sensitive.

- Hex

Specify a 10-digit or 26-digit string that can contain hexadecimal (0 to 9, A to F, and a to f).

- **Key Length**

Length of the WEP key. Select either 64 bits or 128 bits. Longer key length allows you to set a more complex WEP key.

## L

- **Link Quality**

The status of connection between the access point and the printer excluding noise (interference) is indicated with a value from 0 to 100%.

- **LPR**

A platform-independent printing protocol used in TCP/IP networks. It is not supported bidirectional communication.

## M

- **MAC Address**

Also known as the physical address. A unique and permanent hardware identifier that is assigned to network devices by its manufacturer. MAC addresses are 48 bits long and are written as a hexadecimal number separated by colons, i.e., 11:22:33:44:55:66.

## O

- **Operation Status**

Indicates the status on whether the printer can be used.

## P

- **Proxy server**

A server that links a LAN-connected computer to the Internet. When using a proxy server, specify the address and the port number of the proxy server.

- **PSK**

An encryption method employed by WPA/WPA2.

## R

- **Router**

A relay device to connect to another network.

## S

- **Signal Strength**

The strength of the signal received by the printer from the access point is indicated with a value from 0 to 100%.

- **SSID**

Unique label for wireless LAN. It is often represented such as a network name or an access point name.

SSID distinguishes one wireless LAN from another to prevent interference.

The printer and all clients on a wireless LAN must use the same SSID in order to communicate with each other. The SSID can be up to 32 characters long, and is made up of alphanumeric characters. The SSID may also be referred to by its network name.

- **Stealth**

In the stealth mode, an access point hides itself by not broadcasting its SSID. The client must specify the SSID set to the access point to detect it.

- **Subnet Mask**

IP address has two components, the network address and the host address. Subnet Mask used to calculate the Subnet Mask address from the IP address. A Subnet Mask is usually assigned by an access point or a DHCP server of the router automatically.

Example:

IP Address: 192.168.127.123

Subnet Mask: 255.255.255.0

Subnet Mask Address: 192.168.127.0

## T

- **TCP/IP**

Suite of communications protocols used to connect hosts on the Internet or the LAN. This protocol allows different terminals to communicate with each other.

- **TKIP**

An encryption protocol employed by WPA/WPA2.

## U

- **USB**

Serial interface designed to enable you to "hot-swap" devices, i.e., by plugging and unplugging them without turning off the power.

## W

- **WCN (Windows Connect Now)**

Users running Windows Vista or later can obtain the setting information directly via wireless network (WCN-NET).

- **WEP/WEP Key**

An encryption method employed by IEEE 802.11. Shared security key used to encrypt and decrypt data sent over wireless networks. This printer supports key length of 64 bits or 128 bits, key format of ASCII code or Hexadecimal, and key number of 1 to 4.

- **Wi-Fi**

International association that certifies interoperability of wireless LAN products based on the IEEE 802.11 specification.



This machine is a Wi-Fi authorized product.

- **Wireless LAN**

A network that, instead of being connected by physical wires, is connected by a wireless technology, such as Wi-Fi.

- **WPA**

Security framework announced by the Wi-Fi Alliance in October 2002. The security has been strengthened more than WEP.

- Authentication

WPA defines the following authentication methods: PSK that can be used without an authentication server, plus WPA-802.1x that do require an authentication server.

This machine supports WPA-PSK.

- Passphrase

This encrypted key is used to perform WPA-PSK authentication.

The passphrase should be a string of 8 to 63 alphanumeric characters or a 64-digit hexadecimal value.

- **WPA2**

Security framework released by the Wi-Fi Alliance in September 2004 as a later version of WPA. Provides a stronger encryption mechanism through Advanced Encryption Standard (AES).

- Authentication

WPA2 defines the following authentication methods: PSK that can be used without an authentication server, plus WPA2-802.1x that do require an authentication server.

This machine supports WPA2-PSK.

- Passphrase

This encrypted key is used to perform WPA2-PSK authentication.

The passphrase should be a string of 8 to 63 alphanumeric characters or a 64-digit hexadecimal value.

- **WPS (Wi-Fi Protected Setup)**

WPS is a standard for easy and secure establishment of a wireless network.

There are 2 primary methods used in the Wi-Fi Protected Setup:

PIN entry: a mandatory method of setup for all WPS certified devices

Push button configuration (PBC): an actual push button on the hardware or through a simulated push button in the software.

## **Restrictions**

If you use a printer over the wireless LAN, the printer may recognize nearby wireless systems, you should set a network key (WEP, WPA, or WPA2) to the access point to encrypt wireless transmission. Wireless communication with a product that does not comply with the Wi-Fi standard cannot be guaranteed.

Connecting with too many computers may affect the printer performance, such as printing speed.

# About Firewall

A firewall is a function of the security software installed in the computer or operation system for computer, and is a system that is designed to prevent unauthorized access to a network.

## Precautions When a Firewall Function is Enabled

- A firewall function may limit communications between a printer and a computer. This may disable printer setup and communications.
- During the printer setup, you may be prompted to enable or disable communications, depending on the firewall function of the security software or operation system. If so, choose to enable communications.
- When using IJ Network Tool, you may be prompted to enable or disable communications, depending on the firewall function of the security software. If so, choose to enable communications.
- If you cannot set up the printer, temporarily disable the firewall function of the security software or operation system.

### ►► Important

- If you disabled the firewall function, disconnect your network from the Internet.

- Some applications (like the network configuration software) override firewall settings. Check the application's settings beforehand.
- If the printer you use is set to **Get IP address automatically**, the IP address changes every time the printer connects to the network. This may disable printer setup and communications, depending on the firewall settings. In this case, either change the firewall settings or assign a fixed IP address to the printer. An IP address can be set using IJ Network Tool.

➡ [Changing the Settings in the Wireless LAN Sheet](#)

➡ [Changing the Settings in the Wired LAN Sheet](#)

When assigning a fixed IP address to the printer, you will need to specify an IP address with which the computer can communicate.

### ►► Note

- For the operation system firewall settings or the security software firewall settings, refer to the instruction manual of the computer or software, or contact its manufacturer.

## Tips for Ensuring Optimal Printing Quality

- Useful Information about Ink
- Key Points to Successful Printing
- Be Sure to Make Paper Settings after Loading Paper
- Canceling a Print Job
- Key to Enjoying Consistent Printing Quality
- Precautions for Safe Transport of the Machine

## Useful Information about Ink

### How is ink used for various purposes other than printing?

Ink may be used for purposes other than printing.

When you use the Canon printer for the first time after you install the bundled ink tanks, the printer consumes a small amount of ink in the amount to enable printing by filling the nozzles of the Print Head with ink. For this reason, the number of sheets that can be printed with the first ink tanks is fewer than the succeeding ink tanks.

The printing costs described in the brochures or websites are based on the consumption data from not the first ink tank /ink cartridge but the succeeding ink tank /ink cartridge.

Ink is sometimes used to maintain the optimal printing quality.

To keep printer's performance, Canon printer performs cleaning automatically according to its condition. When the printer performs cleaning, a small amount of ink is consumed. In this case, all colors of ink may be consumed.

#### [Cleaning function]

The cleaning function helps the printer to suck air bubbles or ink itself from the nozzle and thus prevents print quality degradation or nozzle clogging.

### Does black-and-white printing use color ink?

Black-and-white printing may use ink other than black ink depending on the type of printing paper or the settings of the printer driver. So, color ink is consumed even when printing in black-and-white.

### Why does the machine have two black ink tanks?

There are two kinds of black ink in the machine: dye ink (BK) and pigment ink (PGBK).

The dye ink is used mainly for printing photos, illustration, etc., and the pigment ink is used for text-based documents. Each has different purposes so that even if one runs out, another will not be used instead. If either of them runs out, the ink tank replacement is required.

These two inks are automatically used depending on the type of printing paper or the settings of the printer driver. You cannot change the usage of these inks yourself.

### The ink lamp indicates when ink is running low.

The inside of the ink tank consists of (A) the part where ink is preserved and (B) the sponge with absorbed ink.

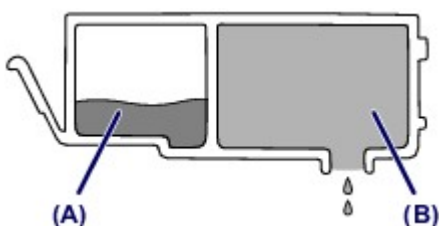

When the ink **(A)** runs out, the ink lamp flashes slowly to indicate that the ink is running low. Then, when the ink **(B)** runs out, the ink lamp flashes fast to indicate that the ink tank needs to be replaced with a new one.

➔ [Checking the Ink Status with the Ink Lamps](#)

# Key Points to Successful Printing

## Check the machine status before printing!

- Is the print head OK?

If a print head nozzle is clogged, print will be faint and papers will be wasted. Print the nozzle check pattern to check the print head.

➔ [Maintenance Procedure](#)

- Is the inside of the machine smeared with ink?

After printing large quantities of paper or performing borderless printing, the area where papers go through may get smeared with ink. Clean the inside of your machine with Bottom Plate Cleaning.

➔ [Cleaning the Inside of the Machine \(Bottom Plate Cleaning\)](#)

## Check how to load the paper correctly!

- Is the paper loaded in the correct orientation?

To load paper in a cassette, load paper WITH THE PRINT SIDE FACING DOWN.

➔ [Loading Paper](#)

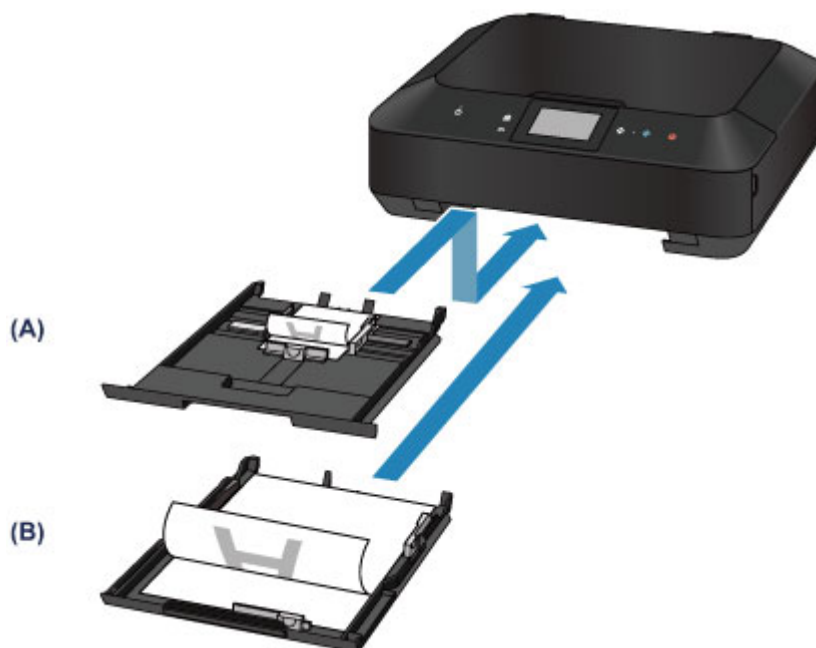

(A) cassette (upper)

(B) cassette (lower)

- Is the paper curled?

The curled paper causes paper jam. Flatten the curled paper, then reload it.

➔ "Load the paper after correcting its curl." in Paper Is Smudged/Printed Surface Is Scratched

## Be Sure to Make Paper Settings after Loading Paper

If the media type setting is not the one for the loaded paper, printing results may not be satisfactory. After loading paper, be sure to select the appropriate media type setting for the loaded paper.

### ➔ Print Results Not Satisfactory

There are various types of paper: paper with special coating on the surface for printing photos with optimal quality and paper suitable for documents.

Each media type has specific preset settings, such as how ink is used and sprayed, distance from nozzles, etc., so that you can print on that type with optimal image quality. This allows you to print with the settings best suited for the loaded media type just by selecting that media type.



## Canceling a Print Job

### Never touch the ON button!

If you touch the **ON** button while printing is in progress, the print data sent from the computer queues in the machine and you may not be able to continue to print.

Touch the **Stop** button to cancel printing.

## Key to Enjoying Consistent Printing Quality

The key to printing with the optimal printing quality is to prevent the print head from drying or clogging. Always observe the following rules for optimal printing quality.

### **Never disconnect the power plug until the power is turned off!**

If you touch the **ON** button to turn off the power, the machine caps the print head (nozzles) automatically to prevent from drying. If you disconnect the power plug from the wall outlet before the **POWER** lamp is turned off, the print head will not be capped properly and this will cause drying or clogging.

When disconnecting the power plug, make sure that the **POWER** lamp is not lit.

→ [Notice for Unplugging the Power Cord](#)

### **Print periodically!**

Just as the tip of a felt pen becomes dry and unusable if it has not been used for a long time, even if it is capped, the print head too, may become dried or clogged if the machine has not been used for a long time.

We recommend you to use the machine at least once a month.

#### **▶▶▶ Note**

- Depending on the type of paper, ink may blur if you trace the printed area with a highlight pen or paint-stick, or bleed if water or sweat comes in contact with the printed area.

# Precautions for Safe Transport of the Machine

When relocating the machine, make sure of the following.

## »» Important

### When sending the machine for repair

- Pack the machine in a sturdy box so that it is placed with its bottom facing down, using sufficient protective material to ensure safe transport.
- With the print head and ink tank left installed in the machine, touch the **ON** button to turn off the power. This allows the machine to automatically cap the print head, thus preventing it from drying.
- After packing, do not tilt the box containing the machine or turn it on its side or upside down. Doing so may cause the ink to leak during transport and cause damage to the machine.
- When a shipping agent is handling transport of the machine, have its box marked "THIS SIDE UP" to keep the machine with its bottom facing down. Mark also with "FRAGILE" or "HANDLE WITH CARE".

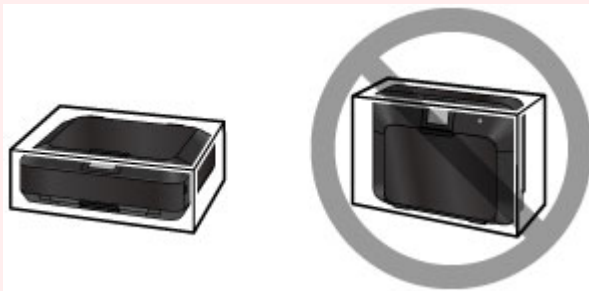

1. Turn the machine off.

2. Confirm that the **POWER** lamp is off and unplug the machine.

➔ [Notice for Unplugging the Power Cord](#)

## »» Important

- Do not unplug the machine while the **POWER** lamp is lit or flashing, as it may cause malfunction or damage to the machine, making the machine unable to print.

3. Retract the paper output support, then close the paper output tray gently.

The output tray extension is retracted automatically when the paper output tray is closed.

4. Disconnect the printer cable from the computer and from the machine, then disconnect the power plug from the machine.

- 5.** Use adhesive tape to secure all the covers on the machine to keep them from opening during transportation. Then pack the machine in the plastic bag.
  
- 6.** Attach the protective material to the machine when packing the machine in the box.

# Legal Limitations on Use of Your Product and Use of Images

It may be unlawful to make copies of, scan, print, or use reproductions of the following documents.

The list provided is non-exhaustive. When in doubt, check with a legal representative in your jurisdiction.

- Paper money
- Money orders
- Certificates of deposit
- Postage stamps (canceled or uncanceled)
- Identifying badges or insignias
- Selective service or draft papers
- Checks or drafts issued by governmental agencies
- Motor vehicle licenses and certificates of title
- Traveler's checks
- Food stamps
- Passports
- Immigration papers
- Internal revenue stamps (canceled or uncanceled)
- Bonds or other certificates of indebtedness
- Stock certificates
- Copyrighted works/works of art without permission of copyright owner

# Specifications

## General Specifications

<b>Printing resolution (dpi)</b>	9600* (horizontal) x 2400 (vertical) * Ink droplets can be placed with a pitch of 1/9600 inch at minimum.
<b>Interface</b>	<b>USB Port:</b> Hi-Speed USB *1 <b>LAN Port:</b> Wired LAN: 100BASE-TX/10BASE-T Wireless LAN: IEEE802.11n/IEEE802.11g/IEEE802.11b *2 *1 A computer that complies with Hi-Speed USB standard is required. Since the Hi-Speed USB interface is fully upwardly compatible with USB 1.1, it can be used at USB 1.1. *2 Setup possible through Standard setup, WPS (Wi-Fi Protected Setup), WCN (Windows Connect Now) or Cableless setup.
<b>Print width</b>	8 inches/203.2 mm (for Borderless Printing: 8.5 inches/216 mm)
<b>Operating environment</b>	<b>Temperature:</b> 41 to 95 °F (5 to 35 °C) <b>Humidity:</b> 10 to 90 % RH (no condensation)
<b>Storage environment</b>	<b>Temperature:</b> 32 to 104 °F (0 to 40 °C) <b>Humidity:</b> 5 to 95 % RH (no condensation)
<b>Power supply</b>	AC 100-240 V, 50/60 Hz
<b>Power consumption</b>	<b>Printing (Copy):</b> Approx. 17 W <b>Standby (minimum):</b> Approx. 1 W *1*2 <b>OFF:</b> Approx. 0.2 W *1 *1 USB connection to PC *2 The wait time for standby cannot be changed.
<b>External dimensions</b>	Approx. 18.4 (W) x 14.6 (D) x 5.9 (H) inches Approx. 466 (W) x 369 (D) x 148 (H) mm * With the Paper Output Tray retracted.
<b>Weight</b>	Approx. 18.1 lb (Approx. 8.2 kg) * With the Print Head and ink tanks installed.
<b>Print Head/Ink</b>	Total 6656 nozzles (P/BK 1024 nozzles, Y/DyeBK each 512 nozzles, C/M/GY each 1536 nozzles)

## Copy Specifications

<b>Multiple copy</b>	max. 99 pages
<b>Intensity adjustment</b>	9 positions, Auto intensity (AE copy)
<b>Reduction/Enlargement</b>	25 % - 400 % (1 % unit)

## Scan Specifications

<b>Scanner driver</b>	<b>Windows:</b> TWAIN 1.9 Specification, WIA <b>Mac OS:</b> ICA
<b>Maximum scanning size</b>	A4/Letter, 8.5" x 11.7"/216 x 297 mm
<b>Scanning resolution</b>	<b>Optical resolution (horizontal x vertical) max:</b> 2400 x 4800 dpi *1 <b>Interpolated resolution max:</b> 19200 x 19200 dpi *2 *1 Optical Resolution represents the maximum sampling rate based on ISO 14473. *2 Increasing the scanning resolution will limit the maximum possible scanning area.
<b>Gradation (Input/Output)</b>	<b>Gray:</b> 16 bit/8 bit <b>Color:</b> 48 bit/24 bit (RGB each 16 bit/8 bit)

## Network Specifications

<b>Communication protocol</b>	TCP/IP
<b>Wired LAN</b>	<b>Supported Standards:</b> IEEE802.3u (10BASE-TX)/IEEE802.3 (10BASE-T) <b>Transfer speed:</b> 10 M/100 Mbps (auto switching)
<b>Wireless LAN</b>	<b>Supported Standards:</b> IEEE802.11n/IEEE802.11g/IEEE802.11b <b>Frequency bandwidth:</b> 2.4 GHz <b>Channel:</b> 1-11 or 1-13 * Frequency bandwidth and available channels differ depending on country or region. <b>Transfer speed (Standard value):</b> IEEE802.11n: max. 150 Mbps IEEE802.11g: max. 54 Mbps IEEE802.11b: max. 11 Mbps * These values are a theoretical maximum transmission speed between the printer and an equivalent network device, and do not indicate the actual transmission speed obtained. <b>Communication distance:</b> Indoors 164 feet/50 m

	<p>* Effective range varies depending on the installation environment and location.</p> <p><b>Security:</b>  WEP (64/128 bits)  WPA-PSK (TKIP/AES)  WPA2-PSK (TKIP/AES)</p> <p><b>Setup:</b>  Standard setup  WPS (Push button configuration/PIN code method)  WCN (WCN-NET)  Cableless setup</p> <p><b>Other Features:</b> Administration password</p>
--	---

## Minimum System Requirements

Conform to the operating system's requirements when higher than those given here.

### Windows

<b>Operating System</b>	Windows 8 Windows 7, Windows 7 SP1 Windows Vista SP1, Windows Vista SP2 Windows XP SP3 32-bit only
<b>Browser</b>	Internet Explorer 8 or later
<b>Hard Disk Space</b>	3 GB Note: For bundled software installation. The necessary amount of hard disk space may be changed without notice.
<b>Display</b>	XGA 1024 x 768

### Mac OS

<b>Operating System</b>	Mac OS X v10.6.8 or later
<b>Browser</b>	Safari 5 or later
<b>Hard Disk Space</b>	1.5 GB Note: For bundled software installation. The necessary amount of hard disk space may be changed without notice.
<b>Display</b>	XGA 1024 x 768



## Other Supported OS

Some functions may not be available with each OS. Refer to the manual or the Canon web site for details on operation with iOS, Android, and Windows RT.

## Mobile Printing Capability

### Apple AirPrint

### Google Cloud Print

### Print from E-mail

- An internet connection is required to view the *Online Manual*.
- Windows: Operation can only be guaranteed on a computer with Windows 8, Windows 7, Windows Vista or Windows XP pre-installed.
- Windows: A CD-ROM Drive or internet connection is required during software installation.
- Windows: Internet Explorer 8, 9 or 10 is required to install Easy-WebPrint EX. Easy-WebPrint EX for Internet Explorer 10 can be downloaded from the Canon web site.
- Windows: Some functions may not be available with Windows Media Center.
- Windows: .NET Framework 4 or 4.5 must be installed to use the Windows software.
- Windows: XPS Essentials Pack is required to print on Windows XP.
- Mac OS: Hard Disk must be formatted as Mac OS Extended (Journaled) or Mac OS Extended.
- Mac OS: For Mac OS, an internet connection is required during software installation.
- Windows: The TWAIN driver (ScanGear) is based on the TWAIN 1.9 Specification and requires the Data Source Manager bundled with the operating system.

Specifications are subject to change without notice.