

ML-1910 Series
ML-2525 Series
ML-2580 Series

Mono Laser Printer User's Guide

imagine the possibilities

Thank you for purchasing a Samsung product.



copyright

© 2009 Samsung Electronics Co., Ltd. All rights reserved.

This user's guide is provided for information purposes only. All information included herein is subject to change without notice. Samsung Electronics is not responsible for any direct or indirect damages, arising from or related to use of this user's guide.

- Samsung and Samsung logo are trademarks of Samsung Electronics Co., Ltd.
- PCL and PCL 6 are trademarks of Hewlett-Packard Company.
- Microsoft, Windows, and Windows Vista are either registered trademarks or trademarks of Microsoft Corporation.
- TrueType, LaserWriter and Macintosh are trademarks of Apple Computer, Inc.
- All other brand or product names are trademarks of their respective companies or organizations.

REV. 1.00

contents

COPYRIGHT

2

CONTENTS

3

- 7 Safety information
- 11 Regulatory information
- 18 About this user's guide
- 20 Features of your new product

INTRODUCTION

22

- 22 Machine overview
 - Front view
 - Rear view
- 24 Control panel overview
- 25 Understanding the control panel
 - LEDs
 - Buttons

GETTING STARTED

27

- 27 Setting up the hardware
- 27 Printing a demo page
- 27 Supplied software
- 28 System requirements
 - Windows
 - Macintosh
 - Linux
- 28 Installing USB connected machine's driver
 - Windows
 - Macintosh
 - Linux
- 31 Sharing your machine locally
 - Windows
 - Macintosh

NETWORK SETUP (ML-2580 SERIES ONLY)

32

- 32 Network environment
- 32 Introducing useful network programs
 - SyncThru™ Web Service
 - SyncThru™ Web Admin Service
 - AnyWeb Print
 - SetIP
- 32 Using a wired network
 - Printing network configuration report
 - Setting IP address
 - Network parameter setting
 - Restoring factory default settings
- 34 Installing network connected machine's driver
 - Windows
 - Macintosh
 - Linux
- 36 IPv6 Configuration
 - Printing network configuration report
 - Setting IPv6 addresses
 - Manual address configuration
 - Installing printer driver

contents

Using SyncThru Web Service

BASIC SETUP	38	Altitude adjustment (ML-2580 Series only)
38	38	Setting the default tray and paper In the computer
	38	Changing font setting (ML-2580 Series only)

MEDIA AND TRAY	40	Selecting print media Guidelines to select the print media Media sizes supported in each mode
40	40	Changing the tray size
41	41	Loading paper in the tray Tray 1 Manual tray
42	42	Printing on special media Envelope Transparency Labels Card stock/ Custom-sized paper Letterhead/ Preprinted paper Photo Glossy
44	44	Using the output support

PRINTING	45	Printer driver features Printer driver
45	45	Basic printing Canceling a print job
46	46	Opening printing preferences Using a favorite setting
46	46	Using help
46	46	Using special print features Printing multiple pages on one sheet of paper Printing posters Printing booklets Printing on both sides of paper (Manual) Change percentage of your document Fitting your document to a selected paper size Using watermarks Using overlay Advanced Options
49	49	Changing the default print settings
50	50	Setting your machine as a default machine
50	50	Printing to a file (PRN)
50	50	Macintosh printing Printing a document Changing printer settings Printing multiple pages on one sheet of paper
51	51	Linux printing Printing from applications Printing files Configuring printer properties

contents

MANAGEMENT TOOLS	53	Introducing useful management tools
	53	Using SyncThru™ Web Service (ML-2580 Series only) To access SyncThru™ Web Service: SyncThru™ Web Service overview E-mail notification setup
	54	Using the Smart Panel program Understanding Smart Panel Changing the Smart Panel Program Settings
	54	Using SetIP program (ML-2580 Series only) Windows Macintosh Linux
	55	Using the Unified Linux Driver Configurator Opening the Unified Driver Configurator Printers configuration Ports configuration
MAINTENANCE	58	Printing a machine report
	58	Monitoring the supplies life
	58	Using toner low alert (ML-2580 Series only)
	58	Cleaning a machine Cleaning the outside Printing a cleaning sheet Cleaning the inside
	59	Storing the Toner cartridge Handling instructions Use of non-Samsung and refilled toner cartridge Estimated cartridge life
	59	Tips for moving & storing your machine
TROUBLESHOOTING	60	Redistributing toner
	60	Tips for avoiding paper curls
	61	Tips for avoiding paper jams
	61	Clearing paper jams In tray In the manual tray Inside the machine In exit area
	63	Solving other problems Paper feeding problems Printing problems Printing quality problems Common Windows problems Common Linux problems Common Macintosh problems
SUPPLIES	69	How to purchase
	69	Available supplies
	69	Available maintenance parts
	69	Replacing the toner cartridge

contents

SPECIFICATIONS 71

- 71 General specifications
- 72 Printer specifications
- 73 Print media specifications

CONTACT SAMSUNG WORLDWIDE 74

GLOSSARY 76









safety information

These warnings and precautions are included in order to prevent injury to you and others, as well as preventing any potential damage to your machine. Be sure to read and understand all of these instructions before using the machine. Use common sense for operating any electrical appliance and whenever using your machine. Also, follow all warnings and instructions marked on the machine and in the accompanying literature. After reading this section, keep it in a safe place for future reference.

IMPORTANT SAFETY SYMBOLS

This section explains the meanings of all icons and signs in the user's guide. These safety symbols are in order, according to the degree of danger.

Explanation of all icons and signs used in the user's guide:

	Warning	Hazards or unsafe practices that may result in severe personal injury or death.
	Caution	Hazards or unsafe practices that may result in minor personal injury or property damage.
	Do not attempt.	
	Do not disassemble.	
	Do not touch.	
	Unplug the power cord from the wall socket.	
	Make sure the machine is grounded to prevent electric shock.	
	Call the service center for help.	
	Follow directions explicitly.	

OPERATING ENVIRONMENT

Warning



Do not use if the power cord is damaged or if the electrical outlet is not grounded.
▶ This could result in electric shock or fire.



Do not bend, or place heavy objects on the power cord.
▶ Stepping on or allowing the power cord to be crushed by a heavy object could result in electric shock or fire.



Do not place anything on top of the machine (water, small metal or heavy objects, candles, lit cigarettes, etc.).
▶ This could result in electric shock or fire.



Do not remove the plug by pulling on the cord; do not handle the plug with wet hands.
▶ This could result in electric shock or fire.

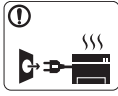

If the machine gets overheated, it releases smoke, makes strange noises, or generates an odd odor, immediately turn off the power switch and unplug the machine.

▶ This could result in electric shock or fire.

Caution



During an electrical storm or for a period of non-operation, remove the power plug from the electrical outlet.

▶ This could result in electric shock or fire.



Be careful, the paper output area is hot.
▶ Burns could occur.



If the machine has been dropped, or if the cabinet appears damaged, unplug the machine from all interface connections and request assistance from qualified service personnel.
▶ Otherwise, this could result in electric shock or fire.



If the machine exhibits a sudden and distinct change in performance, unplug the machine from all interface connections and request assistance from qualified service personnel.

▶ Otherwise, this could result in electric shock or fire.



If the plug does not easily enter the electrical outlet, do not attempt to force it in.

▶ Call an electrician to change the electrical outlet, or this could result in electric shock.



Do not allow pets to chew on the AC power, telephone or PC interface cords.

▶ This could result in electric shock or fire.



If the machine does not operate properly after these instructions have been followed, unplug the machine from all interface connections and request assistance from qualified service personnel.

▶ Otherwise, this could result in electric shock or fire.

OPERATING METHOD

Caution



Do not forcefully pull the paper out during printing.
▶ It can cause damage to the machine.



Be careful not to put your hand between the machine and paper tray.
▶ You may get injured.



Do not block or push objects into the ventilation opening.
▶ This could result in elevated component temperatures which can cause damage or fire.



Use care to avoid paper cuts when replacing paper or removing jammed paper.
▶ You may get hurt.



When printing large quantities, the bottom part of the paper output area may get hot. Do not allow children to touch.

▶ Children may be burned.



When removing jammed paper, do not use tweezers or sharp metal objects.

▶ It can cause damage to the machine.



Do not allow too many papers to stack up in the paper output tray.

▶ It could cause damage to the machine.



This machine's power interception device is the power cord.

▶ To switch off the power supply, remove the power cord from the electrical outlet.

INSTALLATION / MOVING

Warning



Do not place the machine in an area with dust, humidity or water leaks.

- ▶ This could result in electric shock or fire.

Caution



When moving the machine, turn the power off and disconnect all cords; then lift the machine with at least two people.

- ▶ The machine could fall, causing human injury or machine damage.



Do not place the machine on an unstable surface.

- ▶ The machine could fall, causing human injury or machine damage.



The machine should be connected to the power level which is specified on the label.

- ▶ If you are unsure and want to check the power level you are using, contact the electrical utility company.



Use only No.26 AWG^a or larger, telephone line cord, if necessary.

- ▶ Otherwise, it can cause damage to the machine.



Do not put a cover over the machine or place it in an airtight location, such as a closet.

- ▶ If the machine is not well-ventilated, this could result in fire.



Make sure you plug the power cord into a grounded electrical outlet.

- ▶ Otherwise, this could result in electric shock or fire.



Do not overload wall outlets and extension cords.

- ▶ This can diminish performance, and could result in electric shock or fire.



Use the power cord supplied with your machine for safe operation. If you are using a cord which is longer than 2 meters (79") with a 140V machine, then the gauge should be 16 AWG or larger.

- ▶ Otherwise, it can cause damage to the machine, and could result in electric shock or fire.

a. AWG: American Wire Gauge

MAINTENANCE / CHECKING

Caution



Unplug this product from the wall outlet before cleaning the inside of the machine. Do not clean the machine with benzene, paint thinner or alcohol; do not spray water directly into the machine.

- ▶ This could result in electric shock or fire.



Keep cleaning supplies away from children.

- ▶ Children may get hurt.



When you are working inside the machine replacing supplies or cleaning the inside, do not operate the machine.

- ▶ You may get injured.



Do not disassemble, repair or rebuild the machine by yourself.

- ▶ It can cause damage to the machine. Call a certified technician when the machine needs repair.

- ⓘ Keep the power cable and the contact surface of the plug clean from dust or water.
 - ▶ This could result in electric shock or fire.
- ⊗ Do not remove any covers or guards that are fastened with screws.
 - ▶ The machine should only be repaired by Samsung service technician.

- ⓘ To clean and operate the machine, strictly follow the user's guide provided with the machine.
 - ▶ Otherwise, it can cause damage to the machine.

SUPPLY USAGE

Caution



- Do not disassemble the toner cartridge.
 - ▶ Toner dust can be dangerous to humans.



- Do not burn any of the supplies such as toner cartridge or fuser unit.
 - ▶ It can cause an explosion or fire.

- ⓘ When changing the toner cartridge or removing jammed paper, be careful not to let toner dust touch your body or clothes.
 - ▶ Toner dust can be dangerous to humans.



- When storing supplies such as toner cartridges, keep them away from children.
 - ▶ Toner dust can be dangerous to humans.

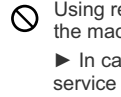

- Using recycled supplies, such as toner, can cause damage to the machine.
 - ▶ In case of damage due to the use of recycled supplies, a service fee will be charged.

regulatory information

This machine is designed for our sound environment and certified with several regulatory statements.

LASER SAFETY STATEMENT

The printer is certified in the U.S. to conform to the requirements of DHHS 21 CFR, chapter 1 Subchapter J for Class I(1) laser products, and elsewhere is certified as a Class I laser product conforming to the requirements of IEC 825.

Class I laser products are not considered to be hazardous. The laser system and printer are designed so there is never any human access to laser radiation above a Class I level during normal operation, user maintenance or prescribed service condition.

WARNING

Never operate or service the printer with the protective cover removed from Laser/Scanner assembly. The reflected beam, although invisible, can damage your eyes.

When using this product, these basic safety precautions should always be followed to reduce risk of fire, electric shock, and injury to persons:

	CAUTION - CLASS 2B LASER RADIATION WHEN OPEN AVOID EXPOSURE TO THE BEAM.
	DANGER - LASER RADIATION AVOID DIRECT EXPOSURE TO BEAM.
	DANGER - RADIATIONS INVISIBLES DU LASER EN CAS D'OUVERTURE. EVITER TOUTE EXPOSITION DIRECTE AU FAISCEAU.
	VORSICHT - UNSICHTBARE LASERSTRAHLUNG. WENN ABDECKUNG GEÖFFNET, NICHT DEM STRAHL AUSSETZEN.
	ATTENZIONE - RADIAZIONE LASER INVISIBILE IN CASO DI APERTURA. EVITARE L'ESPOSIZIONE AL FASCIO.
	PRECAUCIÓN - RADIACIÓN LASER INVISIBLE CUANDO SE ABRE. EVITAR EXPONERSE AL RAYO.
	PERIGO - RADIACÃO LASER INVISÍVEL AO ABRIR. EVITE EXPOSIÇÃO DIRECTA AO FEIXE.
	GEVAAR - ONZICHTBARE LASERSTRALLEN BIJ GEOPENDE KLEP. DEZE KLEP NIET OPENEN.
	ADVARSEL - USYNLIG LASERSTRÅLNING VED ÅBNING. UNNGÅ UDSÆTTELSE FOR STRÅLNING.
	ADVARSEL - USYNLIG LASERSTRÅLNING NÅR DEKSEL ÅPNES. UNNGÅ EKSPONERING FOR STRÅLEN.
	VARNING - OSYNLIG LASERSTRÅLNING NÅR DENNA DEL ÄR ÖPPEN. STRÅLEN ÄR FARLIG.
	VAROITUS - NÄKYMÄTÖNTÄ LASERSÄTEILYÄ AVATTAESSA. VARO SUORAA ALTISTUMISTA SÄTEELLE.
	注 意 - 严禁打开此盖，以免激光泄露灼伤
	주 의 - 이 덮개를 열면 레이저광에 노출될 수 있으므로 주의하십시오.

OZONE SAFETY



During normal operation, this machine produces ozone. The ozone produced does not present a hazard to the operator. However, it is advisable that the machine be operated in a well ventilated area.

If you need additional information about ozone, request your nearest Samsung dealer.

POWER SAVER



This printer contains advanced energy conservation technology that reduces power consumption when it is not in active use.

When the printer does not receive data for an extended period of time, power consumption is automatically lowered.

ENERGY STAR and the ENERGY STAR mark are registered U.S. marks.

For more information on the ENERGY STAR program see <http://www.energystar.gov>

RECYCLING



Recycle or dispose of the packaging material for this product in an environmentally responsible manner.

CHINA ONLY

回收和再循环

为了保护环境，我公司已经为废弃的产品建立了回收和再循环系统。我们会为您无偿提供回收同类废旧产品的服务。当您要废弃您正在使用的产品时，请您及时与工厂取得联系，我们会及时为您提供服务。

CORRECT DISPOSAL OF THIS PRODUCT (WASTE ELECTRICAL & ELECTRONIC EQUIPMENT)



(Applicable in the European Union and other European countries with separate collection systems)

This marking shown on the product, accessories or literature indicates that the product and its electronic accessories (e.g. charger, headset, USB cable) should not be disposed of with other household wastes at the end of its working life. To prevent possible harm to the environment or human health from uncontrolled waste disposal, separate this from other types of wastes and recycle it responsibly to promote the sustainable reuse of material resources.

Household users should contact either the retailer where they purchased this product, or their local government office, for details of where and how they can take this item for environmentally safe recycling.

Business users should contact their supplier and check the terms and conditions of the purchase contract. This product should not be mixed with other commercial wastes for disposal.

RADIO FREQUENCY EMISSIONS

FCC Information to the User

This device complies with Part 15 of the FCC Rules. Operation is subject to the following two conditions:

- This device may not cause harmful interference, and
- This device must accept any interference received, including interference that may cause undesired operation.

This equipment has been tested and found to comply with the limits for a Class B digital device, pursuant to Part 15 of the FCC Rules. These limits are designed to provide reasonable protection against harmful interference in a residential installation. This equipment generates, uses and can radiate radio frequency energy and, if not installed and used in accordance with the instructions, may cause harmful interference to radio communications. However, there is no guarantee that interference will not occur in a particular installation. If this equipment does cause harmful interference to radio or television reception, which can be determined by turning the equipment off and on, the user is encouraged to try to correct the interference by one or more of the following measures:

- Reorient or relocate the receiving antenna.
- Increase the separation between the equipment and receiver.
- Connect the equipment into an outlet on a circuit different from that to which the receiver is connected.
- Consult the dealer or experienced radio TV technician for help.

 Change or modifications not expressly approved by the manufacturer responsible for compliance could void the user's authority to operate the equipment.

Canadian Radio Interference Regulations

This digital apparatus does not exceed the Class B limits for radio noise emissions from digital apparatus as set out in the interference-causing equipment standard entitled "Digital Apparatus", ICES-003 of the Industry and Science Canada.

Cet appareil numérique respecte les limites de bruits radioélectriques applicables aux appareils numériques de Classe B prescrites dans la norme sur le matériel brouilleur: "Appareils Numériques", ICES-003 édictée par l'Industrie et Sciences Canada.

RUSSIA ONLY

AE95



REPLACING THE FITTED PLUG (FOR UK ONLY)

Important

The mains lead for this machine is fitted with a standard (BS 1363) 13 amp plug and has a 13 amp fuse. When you change or examine the fuse, you must re-fit the correct 13 amp fuse. You then need to replace the fuse cover. If you have lost the fuse cover, do not use the plug until you have another fuse cover.

Contact the people from you purchased the machine.

The 13 amp plug is the most widely used type in the UK and should be suitable. However, some buildings (mainly old ones) do not have normal 13 amp plug sockets. You need to buy a suitable plug adaptor. Do not remove the moulded plug.



If you cut off the moulded plug, get rid of it straight away.

You cannot rewire the plug and you may receive an electric shock if you plug it into a socket.

Important warning:



You must earth this machine.

The wires in the mains lead have the following color code:

- **Green and Yellow:** Earth
- **Blue:** Neutral
- **Brown:** Live

If the wires in the mains lead do not match the colors marked in your plug, do the following:

You must connect the green and yellow wire to the pin marked by the letter "E" or by the safety 'Earth symbol' or colored green and yellow or green.

You must connect the blue wire to the pin which is marked with the letter "N" or colored black.

You must connect the brown wire to the pin which is marked with the letter "L" or colored red.

You must have a 13 amp fuse in the plug, adaptor, or at the distribution board.

DECLARATION OF CONFORMITY (EUROPEAN COUNTRIES)

Approvals and Certifications



The CE marking applied to this product symbolizes Samsung Electronics Co., Ltd. Declaration of Conformity with the following applicable 93/68/EEC Directives of the European Union as of the dates indicated:

January 1, 1995: Council Directive 2006/95/EC Approximation of the laws of the member states related to low voltage equipment.

January 1, 1996: Council Directive 2004/108/EC (92/31/EEC), approximation of the laws of the Member States related to electromagnetic compatibility.

March 9, 1999: Council Directive 1999/5/EC on radio equipment and telecommunications terminal equipment and the mutual recognition of their conformity. A full declaration, defining the relevant Directives and referenced standards can be obtained from your Samsung Electronics Co., Ltd. representative.

EC Certification

Certification to 1999/5/EC Radio Equipment & Telecommunications Terminal Equipment Directive (FAX)

This Samsung product has been self-certified by Samsung for pan-European single terminal connection to the analogue public switched telephone network (PSTN) in accordance with Directive 1999/5/EC. The product has been designed to work with the national PSTNs and compatible PBXs of the European countries:

In the event of problems, you should contact the Euro QA Lab of Samsung Electronics Co., Ltd. in the first instance.

The product has been tested against TBR21. To assist in the use and application of terminal equipment which complies with this standard, the European Telecommunication Standards Institute (ETSI) has issued an advisory document (EG 201 121) which contains notes and additional requirements to ensure network compatibility of TBR21 terminals. The product has been designed against, and is fully compliant with, all of the relevant advisory notes contained in this document.

OPENSOURCE LICENSE

Copyright (c) 1998-2001 The OpenSSL Project. All rights reserved.

Redistribution and use in source and binary forms, with or without modification, are permitted provided that the following conditions are met:

1. Redistributions of source code must retain the above copyright notice, this list of conditions and the following disclaimer.
2. Redistributions in binary form must reproduce the above copyright notice, this list of conditions and the following disclaimer in the documentation and/or other materials provided with the distribution.
3. All advertising materials mentioning features or use of this software must display the following acknowledgment: "This product includes software developed by the OpenSSL Project for use in the OpenSSL Toolkit. (<http://www.openssl.org/>)"
4. The names "OpenSSL Toolkit" and "OpenSSL Project" must not be used to endorse or promote products derived from this software without prior written permission. For written permission, please contact openssl-core@openssl.org.
5. Products derived from this software may not be called "OpenSSL" nor may "OpenSSL" appear in their names without prior written permission of the OpenSSL Project.
6. Redistributions of any form whatsoever must retain the following acknowledgment: "This product includes software developed by the OpenSSL Project for use in the OpenSSL Toolkit (<http://www.openssl.org/>)"

THIS SOFTWARE IS PROVIDED BY THE OpenSSL PROJECT "AS IS" AND ANY EXPRESSED OR IMPLIED WARRANTIES, INCLUDING, BUT NOT LIMITED TO, THE IMPLIED WARRANTIES OF MERCHANTABILITY AND FITNESS FOR A PARTICULAR PURPOSE ARE DISCLAIMED. IN NO EVENT SHALL THE OpenSSL PROJECT OR ITS CONTRIBUTORS BE LIABLE FOR ANY DIRECT, INDIRECT, INCIDENTAL, SPECIAL, EXEMPLARY, OR CONSEQUENTIAL DAMAGES (INCLUDING, BUT NOT LIMITED TO, PROCUREMENT OF SUBSTITUTE GOODS OR SERVICES; LOSS OF USE, DATA, OR PROFITS; OR BUSINESS INTERRUPTION) HOWEVER CAUSED AND ON ANY THEORY OF LIABILITY, WHETHER IN CONTRACT, STRICT LIABILITY, OR TORT (INCLUDING NEGLIGENCE OR OTHERWISE) ARISING IN ANY WAY OUT OF THE USE OF THIS SOFTWARE, EVEN IF ADVISED OF THE POSSIBILITY OF SUCH DAMAGE.

This product includes cryptographic software written by Eric Young (eay@cryptsoft.com). This product includes software written by Tim Hudson (tjh@cryptsoft.com).

ORIGINAL SSLEAY LICENSE

Copyright (C) 1995-1998 Eric Young (eay@cryptsoft.com) All rights reserved.

This package is an SSL implementation written by Eric Young (eay@cryptsoft.com). The implementation was written so as to conform with Netscapes SSL.

This library is free for commercial and non-commercial use as long as the following conditions are aheared to. The following conditions apply to all code found in this distribution, be it the RC4, RSA, lhash, DES, etc., code; not just the SSL code. The SSL documentation included with this distribution is covered by the same copyright terms except that the holder is Tim Hudson (tjh@cryptsoft.com). Copyright remains Eric Young's, and as such any Copyright notices in the code are not to be removed. If this package is used in a product, Eric Young should be given attribution as the author of the parts of the library used. This can be in the form of a textual message at program startup or in documentation (online or textual) provided with the package.

Redistribution and use in source and binary forms, with or without modification, are permitted provided that the following conditions are met:

1. Redistributions of source code must retain the copyright notice, this list of conditions and the following disclaimer.
2. Redistributions in binary form must reproduce the above copyright notice, this list of conditions and the following disclaimer in the documentation and/or other materials provided with the distribution.
3. All advertising materials mentioning features or use of this software must display the following acknowledgement: "This product includes cryptographic software written by Eric Young (eay@cryptsoft.com)" The word 'cryptographic' can be left out if the rouines from the library being used are not cryptographic related:-).
4. If you include any Windows specific code (or a derivative thereof) from the apps directory (application code) you must include an acknowledgement: "This product includes software written by Tim Hudson (tjh@cryptsoft.com)"

THIS SOFTWARE IS PROVIDED BY ERIC YOUNG ``AS IS" AND ANY EXPRESS OR IMPLIED WARRANTIES, INCLUDING, BUT NOT LIMITED TO, THE IMPLIED WARRANTIES OF MERCHANTABILITY AND FITNESS FOR A PARTICULAR PURPOSE ARE DISCLAIMED. IN NO EVENT SHALL THE AUTHOR OR CONTRIBUTORS BE LIABLE FOR ANY DIRECT, INDIRECT, INCIDENTAL, SPECIAL, EXEMPLARY, OR CONSEQUENTIAL DAMAGES (INCLUDING, BUT NOT LIMITED TO, PROCUREMENT OF SUBSTITUTE GOODS OR SERVICES; LOSS OF USE, DATA, OR PROFITS; OR BUSINESS INTERRUPTION) HOWEVER CAUSED AND ON ANY THEORY OF LIABILITY, WHETHER IN CONTRACT, STRICT LIABILITY, OR TORT (INCLUDING NEGLIGENCE OR OTHERWISE) ARISING IN ANY WAY OUT OF THE USE OF THIS SOFTWARE, EVEN IF ADVISED OF THE POSSIBILITY OF SUCH DAMAGE.

The licence and distribution terms for any publically available version or derivative of this code cannot be changed. i.e. this code cannot simply be copied and put under another distribution licence [including the GNU Public Licence.

EU DECLARATION OF CONFORMITY



Declaration of Conformity

Manufactured at:

of Samsung Electronics Co., Ltd.
#259, Gongdan-Dong, Gumi-City, Gyeongsangbuk-Do, 730-030 Korea
of Samsung Electronics (Shandong) Digital Printing Co., Ltd.
264209, Samsung Road, Weihai Hi-Tech IDZ, Shandong Province, P. R. China
of Shin Heung Digital Electronics Co., Ltd.
98, Samsung Road, Weihai Hi-Tech IDZ, Shandong Province, P. R. China
(Factory name, address)

We hereby declare, that the product is in compliance with the essential requirements of the Low Voltage Directive (2006/95/EC) and EMC Directive (2004/108/EC) by application of :

- EN 60950-1:2001+A11:2004
- EN 55022:1998 + A1:2000 + A2:2003
- EN 55024:1998 + A1:2001 + A2:2003
- EN 61000-3-2:2006
- EN 61000-3-3:1995 + A1:2001 + A2:2005

The Technical documentation is kept at the below Manufacturer's address.

Manufacturer

Samsung Electronics Co., Ltd.
#259, Gongdan-Dong, Gumi-City
Gyungbuk, Korea 730-030

August 22, 2008

Sung Hwan Baek / S. Manager

Representative in the EU:

Samsung Electronics Euro QA Lab.
Blackbushe Business Park
Saxony Way, Yateley, Hampshire
GU46 6GG, UK

August 22, 2008
(Place and date of issue)

Yong Sang Park / S. Manager

(Name and signature of authorized person)

CHINA ONLY

产品中有毒有害物质或元素的名称及含量

部件名称	有毒有害物质或元素					
	铅 (Pb)	汞 (Hg)	镉 (Cd)	六价铬 (Cr ⁶⁺)	多溴联苯 (PBB)	多溴联苯醚 (PBDE)
塑料	○	○	○	○	○	○
金属 (机箱)	X	○	○	○	○	○
印刷电路部件 (PCA)	X	○	○	○	○	○
电缆 / 连接器	X	○	○	○	○	○
电源设备	X	○	○	○	○	○
电源线	X	○	○	○	○	○
机械部件	X	○	○	○	○	○
卡盒部件	X	○	○	○	○	○
定影部件	X	○	○	○	○	○
扫描仪部件 - CCD (如果有)	X	X	○	○	○	○
扫描仪部件 - 其它 (如果有)	X	○	○	○	○	○
印刷电路板部件 (PBA)	X	○	○	○	○	○
墨粉	○	○	○	○	○	○
滚筒	○	○	○	○	○	○

○：表示该有毒有害物质在该部件所有均质材料中的含量均在 SJ/T 11363-2006 标准规定的限量要求以下。

×：表示该有毒有害物质至少在该部件的某一均质材料中的含量超出 SJ/T 11363-2006 标准规定的限量要求。

以上表为目前本产品含有有毒有害物质的信息。本信息由本公司的配套厂家提供，经本公司审核后而做成，本产品的部分部件含有有毒有害物质，这些部件是在现有科学技术水平下暂时无可替代物质，但三星电子将会一直为满足 SJ/T 11363-2006 标准而做不懈的努力。

about this user's guide

This user's guide provides information about basic understanding of the machine as well as detailed explanation on each step during actual usage. Valuable for both novice and professional users can refer to this as a guide for installing and using the machine.



-  • Read the safety information before using the machine.
- If you have a problem using the machine, refer to the troubleshooting chapter. (See "Troubleshooting" on page 56.)
- Terms used in this user's guide are explained in the glossary chapter. (See "Glossary" on page 72.)
- Use Index to find information.
- All illustrations in this user's guide may differ from your machine depending on its options or models.
- The procedures in this user's guide are mainly based on Windows XP.

CONVENTION

Some terms in this guide are used interchangeably, as below:

- Document is synonymous with original.
- Paper is synonymous with media, or print media.
- Machine refers to printer or MFP.

The following table offers the conventions of this guide:

CONVENTION	DESCRIPTION	EXAMPLE
Bold	For texts on the display or button names on the machine.	Cancel
Note	Provides additional information or detailed specification of the machine function and feature.	 The date format may differ from country to country.
Caution	Gives users information to protect the machine from possible mechanical damage or malfunction.	 Do not touch the green underside of the toner cartridge.
Footnote	Provides additional more detailed information on certain words or a phrase.	a. pages per minute
("Cross-reference")	Guides users to a reference page for the additional detailed information.	(See "Finding more information" on page 15.)

FINDING MORE INFORMATION

You can find information for setting up and using your machine from the following resources, either as a print-out or on screen.

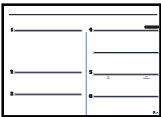
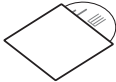
MATERIAL NAME	DESCRIPTION
Quick Install Guide 	This guide provides information on setting up your machine and this requires that you follow the instructions in the guide to prepare the machine.
User's Guide 	This guide provides you with step-by-step instructions for using your machine's full features, and contains information for maintaining your machine, troubleshooting, and installing accessories.
Network Website	If you have network model, you can set the network environment from your computer using network-managing programs, such as SetIP, SyncThru™ Web Admin Service, etc. This Website will be convenient for network administrators who need to manage many machines simultaneously. You can download the SyncThru™ Web Admin Service on http://solution.samsungprinter.com . SetIP program is provided in the software CD.
Machine Driver Help	This help provides you with help information on printer driver and instructions for setting up the options for printing. (See "Using help" on page 42.)
Samsung website	If you have Internet access, you can get help, support, machine drivers, manuals, and order information from the Samsung website, www.samsung.com/printer .

features of your new product

Your new machine is equipped with a number of special features that improve the quality of the documents you print.

SPECIAL FEATURES

Print with excellent quality and speed



- You can print with a resolution of up to 1,200 x 600 dpi (ML-1910 Series, ML-2525 Series) and up to 1,200 x 1,200 dpi (ML-2580 Series) effective output.
- Your machine prints A4-sized paper at up to 18 ppm (ML-1910 Series), 24 ppm (ML-2525 Series, ML-2580 Series) and letter-sized paper at up to 19 ppm (ML-1910 Series), 24 ppm (ML-2525 Series, ML-2580 Series).



IPv6

This machine supports IPv6. (ML-2580 Series only)

Handle many different types of printable material

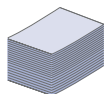

- Manual tray supports plain paper in various sizes, letterhead, envelopes, labels, custom-sized media, postcards, and heavy paper.
- The 250-sheet tray supports plain paper.

Create professional documents

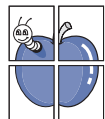

- Print Watermarks. You can customize your documents with words, such as "Confidential". (See "Using watermarks" on page 44.)
- Print Posters. The text and pictures of each page of your document are magnified and printed across the sheet of paper and can then be taped together to form a poster. (See "Printing posters" on page 43.)
- You can use preprinted forms and letterhead with plain paper. (See "Using overlay" on page 44.)

Save time and money



- To save paper, you can print multiple pages on one single sheet of paper. (See "Printing multiple pages on one sheet of paper" on page 42.)
- This machine automatically conserves electricity by substantially reducing power consumption when not in use.
- To save paper, you can print on both sides of the paper (Manual). (See "Printing on both sides of paper (Manual)" on page 43.)

Print in various environments



- You can print with Windows 2000 and Windows XP/2003/2008/Vista as well as Linux and Macintosh systems.
- Your machine is equipped with a USB interface.
- The ML-2580 series comes with a built-in Network interface, 10/100 Base TX.

FEATURES BY MODELS

The machine is designed to support all of your document needs from printing to more advanced networking solutions for your business. Features by models include:

FEATURES	ML-1910 SERIES	ML-2525 SERIES	ML-2580 SERIES
Hi-Speed USB 2.0	● ^a	●	●
Network Interface Ethernet 10/100 Base TX wired LAN			●
Duplex (2-sided) printing (Manual)	●	●	●

a. Compatible with USB 2.0

(●: Included, Blank: Not available)

introduction

This chapter gives you an overview of your machine:

This chapter includes:

- Machine overview
- Control panel overview
- Understanding the control panel

MACHINE OVERVIEW

Front view

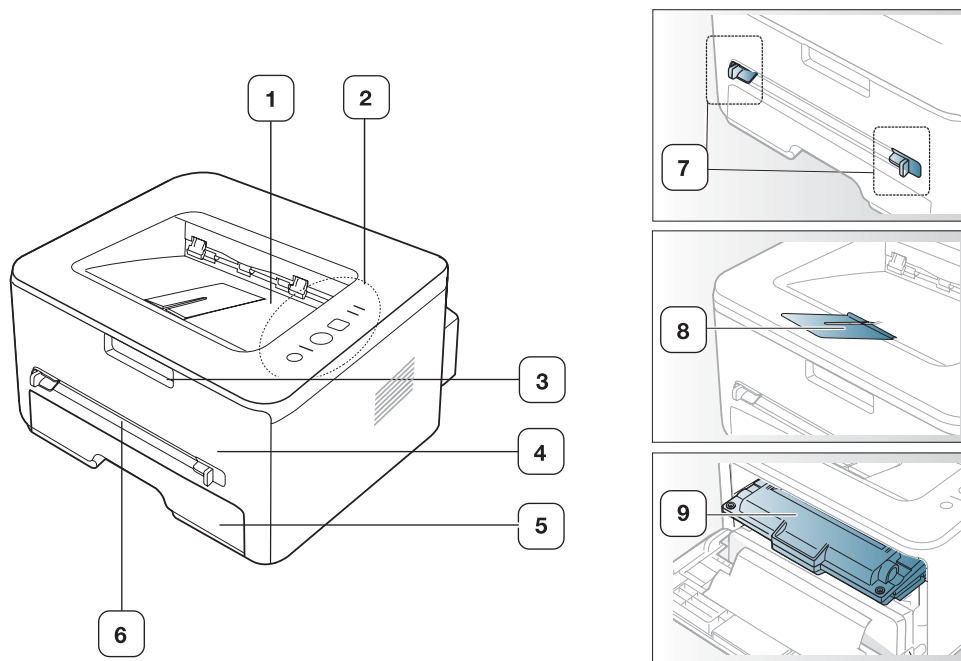

This illustration may differ from your machine depending on its model.

1	Document output tray	6	Manual feeder
2	Control panel	7	Manual feeder guide
3	Front cover handle	8	Output support
4	Front cover	9	Toner cartridge
5	Tray 1		

Rear view

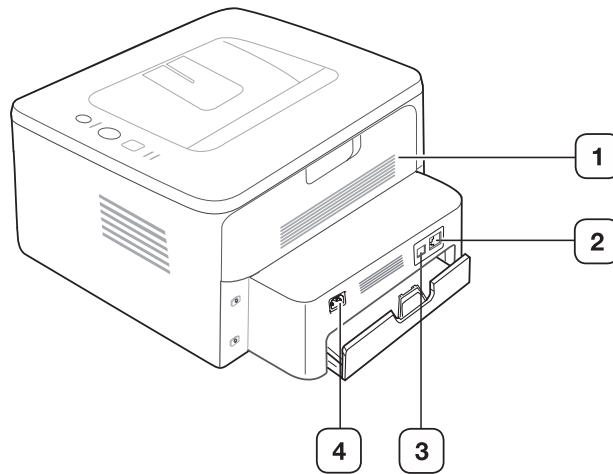

This illustration may differ from your machine depending on its model.

- | | | | |
|---|---------------------------|---|------------------|
| 1 | Rear cover | 4 | USB port |
| 2 | Network Port ^a | 5 | Power receptacle |

a.ML-2580 Series only.

CONTROL PANEL OVERVIEW

This control panel may differ from your machine depending on its model.

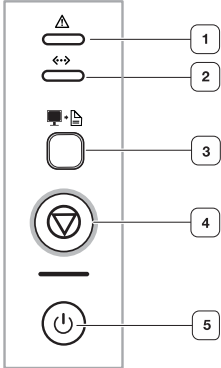



1		Error	Shows the status of your machine. (See "LEDs" on page 21.)
2		Online	Shows the status of your machine. (See "LEDs" on page 21.)
3		Print Screen	Prints the displayed screen in the monitor. (See "Buttons" on page 21.)
4		Cancel	Stops an operation at any time and there are more functions. (See "Understanding the control panel" on page 21.)
5		Power	You can turn the power on and off with this button. (See "Understanding the control panel" on page 21.)

a. ML-1910 Series, ML-2525 Series only.

UNDERSTANDING THE CONTROL PANEL

LEDs

The color of the LEDs indicates the machine's current status.

LED	STATUS		DESCRIPTION
Error 	Red	On	<ul style="list-style-type: none"> The cover is opened. Close the cover. There is no paper in the tray. Load paper in the tray. The machine has stopped due to a major error. Your system has some problems. If this problem occurs, contact your service representative. A toner cartridge has almost reached its estimated cartridge life^a(See "Replacing the toner cartridge" on page 65.)
		Blinking	<ul style="list-style-type: none"> A minor error has occurred and the machine is waiting for the error to be cleared. When the problem is cleared, the machine resumes. Small amount of toner is left in the cartridge. The estimated cartridge life of toner is close. Prepare a new cartridge for replacement. You may temporarily increase the printing quality by redistributing the toner. (See "Redistributing toner" on page 56.)
	Orange	On	A paper jam has occurred. (See "Clearing paper jams" on page 57.)
Online 	Green	On	<ul style="list-style-type: none"> The machine is in power saver mode. The machine is on-line and can receive data from the computer.
		Blinking	<ul style="list-style-type: none"> When the backlight slowly blinks, the machine is receiving data from the computer. When the backlight blinks rapidly, the machine is printing data.

a. Estimated cartridge life means the expected or estimated toner cartridge life, which indicates the average capacity of print-outs and is designed pursuant to ISO/IEC 19752. (See "General specifications" on page 67.) The number of pages may be affected by operating environment, printing interval, media type, and media size. Some amount of toner may remain in the cartridge even when red LED turned on and the printer stops printing.



 Samsung does not recommend using non-genuine Samsung toner cartridge such as refilled or remanufactured. Samsung cannot guarantee non-genuine Samsung toner cartridge's quality. Service or repair required as a result of using non-genuine Samsung toner cartridges will not be covered under the machine warranty.

 All printing errors will be appear in the Smart Panel program window. If the problem persists, call for service.

Buttons

 (Print Screen button)



 ML-1910 Series, ML-2525 Series only.

If you press  (Print Screen button) for more than two seconds, machine prints active screen displayed in the monitor, if you press  (Print Screen button) for less than two seconds, machine prints the whole screen displayed in the monitor. The page will be printed on the default page like A4, Letter.

-  You can only use this function with USB-connect machine.
- Print Screen** can only be used in the Windows and Macintosh.
- You can only use this function if the machine driver is installed.

 (Cancel button)

By pressing the  (cancel button), you can:

FUNCTION	DESCRIPTION
Printing demo page	In Ready mode, press and hold this button for about 2 seconds until the status LED blinks slowly, and release. (See "Printing a demo page" on page 23.)
Printing configuration sheet	In Ready mode, press and hold this button for about 5 seconds until the status LED blinks fast, and release. (See "Printing a machine report" on page 54.)
Printing a cleaning sheet	In Ready mode, press and hold this button for about 8 seconds until the status LED blinks fast, and release. (See "Cleaning the inside" on page 54.)
Printing a supply information report	In Ready mode, press and hold this button for about 10 seconds until the status LED blinks fast, and release. (See "Monitoring the supplies life" on page 54.)
Cancel print job	Press  (cancel button) during printing. The red LED blinks while the print job is cleared from both the machine and the computer and then the machine returns to ready mode. This may take some time depending on the size of the print job.
Manual print	Press  (cancel button) each time you load a sheet of paper in the manual tray when you select Manual Feeder for Source from your software application.

 (Power button)

This button must be used to turn the machine on/off. Also, when the machine is not in use, save electricity by pressing this button.

STATUS	DESCRIPTION
Off	Pressing this button for 2 second will put the machine into an on-line.
On	<ul style="list-style-type: none">• Pressing this button for 2 second will put the machine into an off-line.• Pressing this button for 1.5 second will put the machine into a power save mode.

getting started

This chapter gives you step-by-step instructions for setting up the USB connected machine and software.

This chapter includes:

- Setting up the hardware
- Printing a demo page
- Supplied software

SETTING UP THE HARDWARE

This section shows the steps to set up the hardware, as is explained in the Quick Install Guide. Make sure you read the Quick Install Guide first and follow the steps below:

1. Select a stable location.

Select a level, stable place with adequate space for air circulation. Allow extra space to open covers and trays.

The area should be well ventilated and away from direct sunlight or sources of heat, cold, and humidity. Do not set the machine close to the edge of your desk or table.

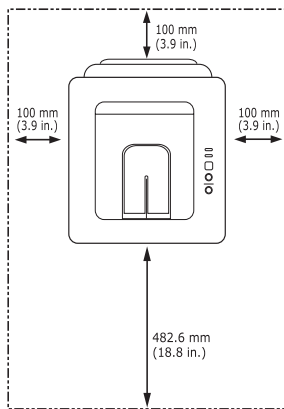

Printing is suitable for altitudes under 1,000 m (3,281 ft). Refer to the altitude setting to optimize your printing. (See "Altitude adjustment (ML-2580 Series only)" on page 34.)

Place the machine on a flat, stable surface so that there is no incline greater than 2 mm (0.08 inch). Otherwise, printing quality may be affected.

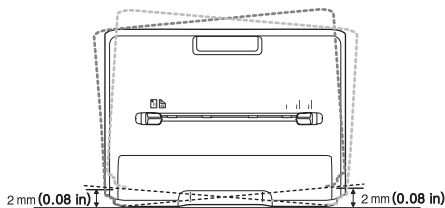

2. Unpack the machine and check all the enclosed items.
3. Remove tape holding the machine securely.
4. Install the toner cartridge.

- System requirements
- Installing USB connected machine's driver
- Sharing your machine locally

5. Load paper. (See "Loading paper in the tray" on page 37.)
6. Make sure that all cables are connected to the machine.
7. Turn the machine on.



This equipment will be inoperable when mains power fails.

PRINTING A DEMO PAGE

Print a demo page to make sure that the machine is operating correctly.

To print a demo page:

In ready mode, press and hold the Ⓞ (cancel button) for about 2 seconds.

SUPPLIED SOFTWARE

After you have set up your machine and connected it to your computer. You must install the printer software using the supplied CD. The software CD provides you with the following software.

OS	CONTENTS
Windows	<ul style="list-style-type: none"> • Printer driver: Use this driver to take full advantage of your machine's features. • Smart Panel: This program allows you to monitor the machine's status and alerts you when an error occurs during printing. • Printer Settings Utility (ML-2580 Series only): This program allows you to set up printer's other options from your computer desktop. • SetIP (ML-2580 Series only): Use this program to set your machine's TCP/IP addresses.
Macintosh	<ul style="list-style-type: none"> • Printer Driver: Use this driver to take full advantage of your machine's features. • Smart Panel: This program allows you to monitor the machine's status and alerts you when an error occurs during printing. • Printer Settings Utility (ML-2580 Series only): This program allows you to set up printer's other options from your computer desktop. • SetIP (ML-2580 Series only): Use this program to set your machine's TCP/IP addresses.
Linux	<ul style="list-style-type: none"> • Unified Linux Driver: Use this driver to take full advantage of your machine's features. • Smart Panel: This program allows you to monitor the machine's status and alerts you when an error occurs during printing. • Printer Settings Utility (ML-2580 Series only): This program allows you to set up printer's other options from your computer desktop. • SetIP (ML-2580 Series only): Use this program to set your machine's TCP/IP addresses.

SYSTEM REQUIREMENTS

Before you begin, ensure that your system meets the following requirements:

Windows

Your machine supports the following Windows operating systems.

OPERATING SYSTEM	REQUIREMENT (RECOMMENDED)		
	CPU	RAM	FREE HDD SPACE
Windows 2000	Pentium II 400 MHz (Pentium III 933 MHz)	64 MB (128 MB)	600 MB
Windows XP	Pentium III 933 MHz (Pentium IV 1 GHz)	128 MB (256 MB)	1.5 GB
Windows Server 2003	Pentium III 933 MHz (Pentium IV 1 GHz)	128 MB (512 MB)	1.25 GB to 2 GB
Windows Server 2008	Pentium IV 1 GHz (Pentium IV 2 GHz)	512 MB (2048 MB)	10 GB
Windows Vista	Pentium IV 3 GHz	512 MB (1024 MB)	15 GB



- Internet Explorer 5.0 or higher is the minimum requirement for all Windows operating systems.
- Users who have an administrator right can install the software.
- **Windows Terminal Services** is compatible with this machine.

Macintosh

OPERATING SYSTEM	REQUIREMENTS (RECOMMENDED)		
	CPU	RAM	FREE HDD SPACE
Mac OS X 10.3 ~ 10.4	<ul style="list-style-type: none"> • Intel Processors • PowerPC G4/ G5 	<ul style="list-style-type: none"> • 128 MB for a PowerPC based Mac (512 MB) • 512 MB for a Intel-based Mac (1 GB) 	1 GB
Mac OS X 10.5 ~ 10.6	<ul style="list-style-type: none"> • Intel Processors • 867 MHz or faster Power PC G4/ G5 	512 MB (1 GB)	1 GB

Linux

ITEM	REQUIREMENTS
Operating system	RedHat 8.0, 9.0 (32bit) RedHat Enterprise Linux WS 4, 5 (32/64bit) Fedora Core 1~7 (32/64bit) Mandrake 9.2 (32bit), 10.0, 10.1 (32/64bit) Mandriva 2005, 2006, 2007 (32/64bit) SuSE Linux 8.2, 9.0, 9.1 (32bit) SuSE Linux 9.2, 9.3, 10.0, 10.1, 10.2 (32/64bit) SuSE Linux Enterprise Desktop 9, 10 (32/64bit) Ubuntu 6.06, 6.10, 7.04 (32/64bit) Debian 3.1, 4.0 (32/64bit)
CPU	Pentium IV 2.4GHz (IntelCore2)
RAM	512 MB (1024 MB)
Free HDD space	1 GB (2GB)

INSTALLING USB CONNECTED MACHINE'S DRIVER

A locally connected machine is a machine directly attached to your computer using the USB cable. If your machine is attached to a network, skip the following steps below and go on to installing network connected machine's driver. (See "Installing network connected machine's driver" on page 30.)



- Only use an USB cable no longer then 3 m (118 in.).

Windows

You can install the machine software using the typical or custom method. The following steps below are recommended for most users who use a machine directly connected to your computer. All components necessary for machine operations will be installed.

1. Make sure that the machine is connected to your computer and powered on.

 If the "New Hardware Wizard" window appears during the installation procedure, click **X** in the upper right corner of the box to close the window, or click **Cancel**.

2. Insert the supplied software CD into your CD-ROM drive.

- The software CD should automatically run and an installation window appear.
- If the installation window does not appear, click **Start** and then **Run**. Type **X:\Setup.exe**, replacing "X" with the letter which represents your drive. Click **OK**.
- If you use Windows Vista, click **Start > All programs > Accessories > Run**. Type **X:\Setup.exe** replacing "X" with the letter which represents your drive and click **OK**.
- If the **AutoPlay** window appears in Windows Vista, click **Run Setup.exe** in **Install or run program** field, and click **Continue** in the **User Account Control** windows.

3. Select **Install now**.

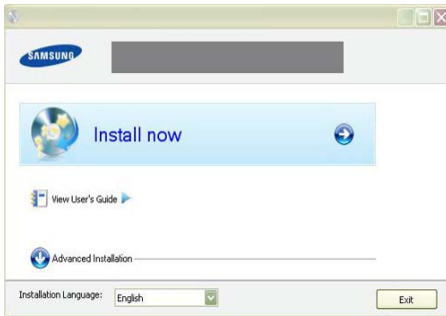

If necessary, select a language from the drop-down list.

4. Read **License Agreement**, and select **I accept the terms of the License Agreement**. Then, click **Next**.

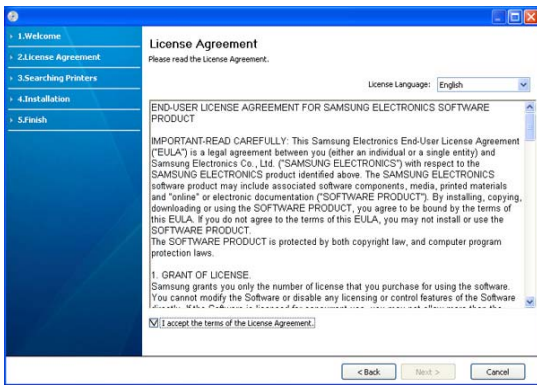

The program searches the machine.

-  • The **Advanced Installation** has two options, **Custom Installation** and **Install Software Only**. The **Custom Installation** allows you to select the machine's connection and choose individual component to install. The **Install Software Only** allows you to install the supplied softwares, such as

Smart Panel. Follow the guide on the window.

- If your machine is not connected to the computer, the following window will appear.

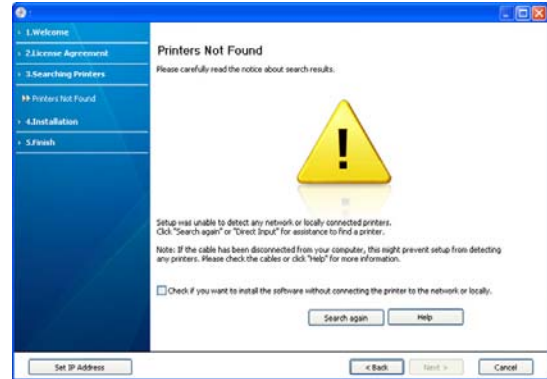

- After connecting the machine, click **Next**.
- If you don't want to connect the machine at this time, click the check box beside of **Check if you want to install the software without connecting the printer to the network or locally**. In this case, the print a test page window will be skipped, and completes the installation.
- The installation window in this User's Guide may differ depending on the machine and interface in use.

5. When the printer connection confirmation window appears, check the printer name and click **Next**.

6. After the installation is finished, a window asking you to print a test page appears. If you want to print a test page, click **Print a test page**.

Otherwise, just click **Next** and skip to step 7.

7. If the test page prints out correctly, click **Yes**. If not, click **No** to reprint it.

8. To register as a user of the machine in order to receive information from Samsung, click **On-line Registration**. You are now registered to the Samsung web site.



9. Click **Finish**.

 If the printer driver does not work properly, follow the steps below to repair or reinstall the driver.

- a) Make sure that the machine is connected to your machine and

powered on.

- b) From the **Start** menu, select **Programs** or **All Programs** > **Samsung Printers** > **your printer driver name** > **Maintenance**.
- c) Select the option as you wish, follow the instruction on the window.

Macintosh

The software CD that came with your machine provides you with the PPD file that allows you to use the CUPS driver or Apple LaserWriter driver (only available when you use a machine which supports the PostScript driver) for printing on a Macintosh computer.

1. Make sure that the machine is connected to your computer and powered on.
2. Insert the supplied software CD into your CD-ROM drive.
3. Double-click the CD-ROM icon that appears on your Macintosh desktop.
4. Double-click the **MAC_Installer** folder.
5. Double-click the **Installer OS X** icon.
6. Enter the password and click **OK**.
7. The Samsung Installer window opens. Click **Continue**.
8. Select **Easy Install** and click **Install**. **Easy Install** is recommended for most users. All components necessary for machine operations will be installed.

If you select **Custom Install**, you can choose individual components to install.

9. When the message which warns that all applications will close on your computer appears, click **Continue**.
10. After the installation is finished, click **Quit**.
11. Open the **Applications** folder > **Utilities** > **Print Setup Utility**.
 - For Mac OS X 10.5~10.6, open the **Applications** folder > **System Preferences** and click **Print & Fax**.
12. Click **Add** on the **Printer List**.
 - For Mac OS X 10.5~10.6, click the "+" icon; a display window will pop up.
13. For Mac OS X 10.3, select the **USB** tab.
 - For Mac OS X 10.4, click **Default Browser** and find the USB connection.
 - For Mac OS X 10.5~10.6, click **Default** and find the USB connection.
14. For Mac OS X 10.3, if Auto Select does not work properly, select **Samsung** in **Printer Model** and your machine name in **Model Name**.
 - For Mac OS X 10.4, if Auto Select does not work properly, select **Samsung** in **Print Using** and your machine name in **Model**.
 - For Mac OS X 10.5~10.6, if Auto Select does not work properly, select **Select a driver to use...** and your machine name in **Print Using**.

Your machine appears on the **Printer List**, and is set as the default machine.

15. Click **Add**.

 If the printer driver does not work properly, uninstall the driver and reinstall it.

Follow steps below to uninstall the driver for Macintosh.

- a) Make sure that the machine is connected to your computer and powered on.
- b) Insert the supplied software CD into your CD-ROM drive.
- c) Double-click CD-ROM icon that appears on your Macintosh desktop.
- d) Double-click the **MAC_Installer** folder.
- e) Double-click the **Installer OS X** icon.
- f) Enter the password and click **OK**.

- g) The Samsung Installer window opens. Click **Continue**.
- h) Select **Uninstall** and click **Uninstall**.
- i) When the message which warns that all applications will close on your computer appears, Click **Continue**.
- j) When the uninstall is done, click **Quit**.

Linux

Follow the steps below to install the driver for Linux. While installing the driver, the Unified Linux Driver package will automatically be installed as well.

 The supplied software CD provides you with the Unified Linux Driver package for using your machine with a Linux computer easily in UI based management tool. (See "Using the Unified Linux Driver Configurator" on page 51.)

1. Make sure that the machine is connected to your computer and powered on.
2. When the **Administrator Login** window appears, type in root in the **Login** field and enter the system password.

 You must log in as a super user (root) to install the machine software. If you are not a super user, ask your system administrator.

3. Insert the supplied software CD into your CD-ROM drive. The software CD will run automatically.

If the software CD does not run automatically, click the  icon at the bottom of the desktop. When the Terminal screen appears, type in the following:

If the software CD is secondary master and the location to mount is /mnt/cdrom,

```
[root@localhost root]#mount -t iso9660 /dev/hdc /mnt/cdrom
[root@localhost root]#cd /mnt/cdrom/Linux
[root@localhost Linux]#./install.sh
```

If you still failed to run the software CD type the followings in sequence:

```
[root@localhost root]#umount /dev/hdc
[root@localhost root]#mount -t iso9660 /dev/hdc /mnt/cdrom
```

 The installation program runs automatically if you have an autorun software package installed and configured.

4. When the welcome screen appears, click **Next**.

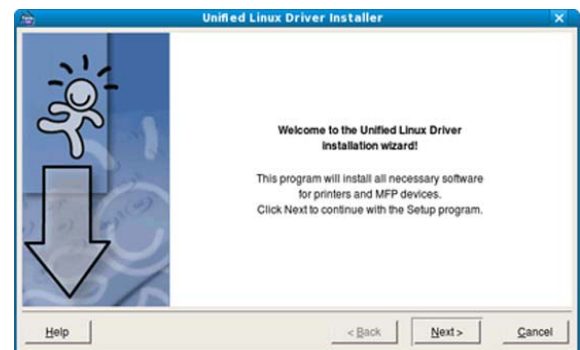

5. When the installation is complete, click **Finish**.

The installation program has added the Unified Driver Configurator desktop icon and the Unified Driver group to the system menu for your convenience. If you have any difficulties, consult the on screen help that is available through your system menu or can otherwise be called from the driver package Windows applications, such as **Unified Driver Configurator** or **Image Manager**.

- ✍ Installing the driver in the text mode:
 - If you do not use the graphical interface or have been unable to install the driver, you have to use the driver in the text mode.
 - Follow the steps 1 to 3, then type `[root@localhost Linux]# ./install.sh`. Follow the instructions on the terminal screen. The installation is completed.
 - When you want to uninstall the driver, follow the installation instructions above, but type `[root@localhost Linux]# ./uninstall.sh` on the terminal screen.

- ✍ If the printer driver does not work properly, uninstall the driver and reinstall it. Follow the steps below steps to uninstall the driver for Linux.
 - a) Make sure that the machine is connected to your computer and powered on.
 - b) When the **Administrator Login** window appears, type in "root" in the **Login** field and enter the system password. You must log in as a super user (root) to uninstall the printer driver. If you are not a super user, ask your system administrator.
 - c) Insert the supplied software CD into your CD-ROM drive. The software CD will run automatically. If the software CD does not run automatically, click the  icon at the bottom of the desktop. When the Terminal screen appears, type in:



```
[root@localhost root]#mount -t iso9660 /dev/hdc /mnt/cdrom
[root@localhost root]#cd /mnt/cdrom/Linux
[root@localhost Linux]#./uninstall.sh
```

 The installation program runs automatically if you have an autorun software package installed and configured.
 - d) Click **Uninstall**.
 - e) Click **Next**.
 - f) Click **Finish**.

SHARING YOUR MACHINE LOCALLY

Follow the steps below to set up the computers to share your machine locally.

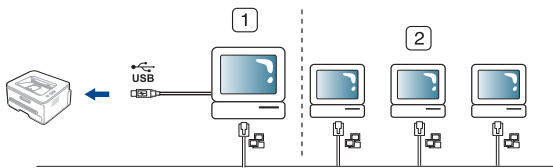
If the Host computer is directly connected to the machine with USB cable and is also connected to the local network environment, the client computer connected to the local network can use the shared machine through the host computer to print.



1	Host computer	A computer which is directly connected to the machine by USB cable.
2	Client computers	Computers which use the machine shared through the host computer.

Windows

Setting up a host computer

1. Install your printer driver. (See "Installing USB connected machine's driver" on page 24, "Installing network connected machine's driver" on page 30.)
2. Click the Windows **Start** menu.
3. For Windows 2000, select **Settings > Printers** .
 - For Windows XP/2003 select **Printer and Faxes**.
 - For Windows 2008/Vista select **Control Panel > Hardware and Sound > Printers**.
4. Double-click your printer driver icon.
5. From the **Printer** menu, select **Sharing...**
6. Check the **Share this printer**.
7. Fill in the **Shared Name** field. Click **OK**.

Setting up a client computer

1. Install your printer driver. (See "Installing USB connected machine's driver" on page 24, "Installing network connected machine's driver" on page 30.)
2. Click the Windows **Start** menu.
3. Select **All programs > Accessories > Window Explorer**.
4. Enter the IP address of the host computer in the address bar and press Enter in your keyboard.



- ✍ In case host computer requires **User name** and **Password**, fill in User ID and password of the host computer account.

5. Right click the printer icon you want to share and select **Connect**.
6. If a set up complete message appears, click **OK**.
7. Open the file you want to print and start printing.

Macintosh

- ✍ The following steps are for Mac OS X 10.5~10.6. Refer to Mac Help for other OS versions.

Setting up a host computer

1. Install your printer driver. (See "Macintosh" on page 26.)
2. Open the **Applications** folder > **System Preferences** and click **Print & Fax**.
3. Select the printer to share in the **Printers list**.
4. Select **Share this printer**.

Setting up a client computer

1. Install your printer driver. (See "Macintosh" on page 26.)
2. Open the **Applications** folder > **System Preferences** and click **Print & Fax**. A display window showing the name of your shared printer appears.
3. Click the "+" icon.
4. Select your machine and click **Add**.

network setup (ml-2580 series only)

This chapter gives you step-by-step instructions for setting up the network connected machine and software.

This chapter includes:

- Network environment
- Introducing useful network programs
- Using a wired network

NETWORK ENVIRONMENT

You need to set up the network protocols on the machine to use it as your network machine. You can set up the basic network settings through the machine's control panel.

The following table shows the network environments supported by the machine:

ITEM	REQUIREMENTS
Network interface	Ethernet 10/100 Base-TX
Network operating system	<ul style="list-style-type: none">• Windows 2000/XP/2003/2008/Vista• Various Linux OS• Mac OS X 10.3 ~ 10.6
Network protocols	<ul style="list-style-type: none">• TCP/IPv4• DHCP, BOOTP• DNS, WINS, Bonjour, SLP, UPnP• Standard TCP/IP Printing (RAW), LPR, IPP• SNMPv 1/2/3, HTTP (S), Telnet, SMTP, LDAP, IPSec• TCP/IPv6 (DHCP, DNS, RAW, LPR, SNMPv 1/2/3, HTTP (S), IPSec) (See "IPv6 Configuration" on page 32.)

INTRODUCING USEFUL NETWORK PROGRAMS

There are several programs available to setup the network settings easily in network environment. For the network administrator especially, managing several machines on the network is possible.

 Before using the programs below, set the IP address first.

SyncThru™ Web Service

Web server embedded on your network machine, which allows you to:

- Configure the network parameters necessary for the machine to connect to various network environments.
- Customize machine settings.

(See "Using SyncThru™ Web Service (ML-2580 Series only)" on page 49.)

- Installing network connected machine's driver
- IPv6 Configuration

SyncThru™ Web Admin Service

Web-based machine management solution for network administrators. SyncThru™ Web Admin Service provides you with an efficient way of managing network devices and lets you remotely monitor and troubleshoot network machines from any site with corporate internet access. Download this program from <http://solution.samsungprinter.com>.

AnyWeb Print

This tool helps you to screen-capture, preview, scrap and print the screen of Windows Internet Explorer more easily, than when you use the ordinary program. Click **Start > All programs > Samsung Printers > your machine name > AnyWeb Print** to link the website where the tool is available for the download. This tool is available only for Windows operating systems.

SetIP

This utility program allows you to select a network interface and manually configure the IP addresses for use with the TCP/IP protocol. (See "IP setting using SetIP Program (Windows)" on page 29, "IP setting using SetIP Program (Macintosh)" on page 29 or "IP setting using SetIP Program (Linux)" on page 30.)

 TCP/IPv6 is not supported by this program.

USING A WIRED NETWORK

You must set up the network protocols on your machine to use it on your network. This chapter will show you how this is easily accomplished.

You can use network after connecting network cable to a corresponding port on your machine.

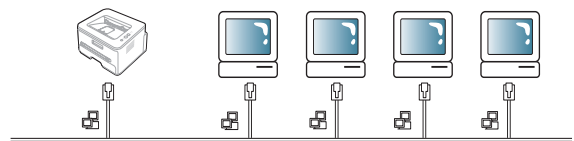

Printing network configuration report

You can print a **Network Configuration Report** from the machine's control panel that will show the current machine's network settings. This will help you to set up a network and troubleshooting problems.

To print the report:

In ready mode, press and hold the  (cancel button) for about 5 seconds. You can find your machine's MAC address and IP address.

For example:

- MAC Address : 00:15:99:41:A2:78

- IP Address : 192.0.0.192

Setting IP address

Firstly, you have to set up an IP address for network printing and managements. In most cases a new IP address will be automatically assigned by a DHCP (Dynamic Host Configuration Protocol) server located on the network.

In a few situations the IP address must be set manually. This is called a static IP and is often required in corporate Intranets for security reasons.

- **DHCP IP assignment:** Connect your machine to the network, and wait a few minutes for the DHCP server to assign an IP address to the machine. Then, print the **Network Configuration Report** as explained above. If the report shows that the IP address has changed, the assignment was successful. You will see the new IP address in the report.
- **Static IP assignment:** Use SetIP program to change the IP address from your computer.

In an office environment, we recommend that you contact a network administrator to set this address for you.

IP setting using SetIP Program (Windows)

This program is for manually setting the network IP address of your machine using its MAC address to communicate with the machine. A MAC address is the hardware serial number of the network interface and can be found in the **Network Configuration Report**.

For using SetIP program, disable the computer firewall before continuing by performing the following:

1. Open **Start > All programs > Control Panel**.
2. Double click **Security Center**.
3. Click **Windows Firewall**.
4. Disable the firewall.

Installing the program

1. Insert the Printer Software CD-ROM provided with your machine. When the driver CD runs automatically, close that window.
2. Start Windows Explorer and open the X drive. (X represents your CD-ROM drive.)
3. Double-click **Application > SetIP**.
4. Double-click **Setup.exe** to install this program.
5. Click **OK**. If necessary, select a language from the drop-down list.
6. Follow the instructions in the window and complete the installation.

Starting the program

1. Connect your machine to the network with a network cable.
2. Turned on the machine.
3. From the Windows **Start** menu, select **All Programs > Samsung Printers > SetIP > SetIP**.
4. Click on the  icon (third from left) in the SetIP window to open the TCP/IP configuration window.

5. Enter the machine's new information into the configuration window as follows. In a corporate intranet, you may need to have this information assigned by a network manager before proceeding.

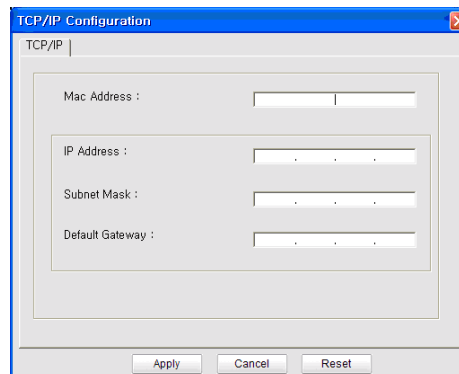

- **MAC Address :** Find the machine's MAC address from the **Network Configuration Report** and enter it without the colons. For example, 00:15:99:29:51:A8 becomes 0015992951A8.
 - **IP Address:** Enter a new IP address for your printer. For example, if your computer's IP address is 192.168.1.150, enter 192.168.1.X. (X is number between 1 and 254 other than the computer's address.)
 - **Subnet Mask:** Enter a Subnet Mask.
 - **Default Gateway:** Enter a Default Gateway.
6. Click **Apply**, and then click **OK**. The machine will automatically print the **Network Configuration Report**. Confirm that all the settings are correct.
 7. Click **Exit** to close the SetIP program.
 8. If necessary, restart the computer's firewall.

IP setting using SetIP Program (Macintosh)

For using SetIP program, disable the computer firewall before continuing by performing the following:

1. Open **System Preferences**.
2. Click **Security**.
3. Click the **Firewall** menu.
4. Turn firewall off.

 The following instructions may vary for your model.

1. Connect your machine to the network with a network cable.
2. Insert the Installation CD-ROM, and open the disk window, select **MAC_Installer > MAC_Printer > SetIP > SetIP.ppplet.html**.
3. Double click the file and **Safari** will automatically open, then select **Trust**. The browser will open the **SetIP.ppplet.html** page that shows the printer's name and IP address information.
4. Highlight the printer information row and select the **Setup icon**, which is the second icon from the left in the application menu bar. A TCP/IP Configuration window will open.

 If the printer was not shown in the information row, select the **Manual Setting icon** (third from left) to open the TCP/IP Configuration window.

5. Enter the machine's new information into the configuration window as follows. In a corporate intranet, you may need to have this information assigned by a network manager before proceeding.

- **MAC Address** : Find the machine's MAC address from the **Network Configuration Report** and enter it without the colons. For example, 00:15:99:29:51:A8 becomes 0015992951A8.
 - **IP Address**: Enter a new IP address for your printer. For example, if your computer's IP address is 192.168.1.150, enter 192.168.1.X. (X is number between 1 and 254 other than the computer's address.)
 - **Subnet Mask**: Enter a Subnet Mask.
 - **Default Gateway**: Enter a Default Gateway.
6. Select **Apply**, then **OK**, and **OK** again. The printer will automatically print the configuration report. Confirm that all the settings are correct. **Quit Safari**. You may close and eject the installation CD-ROM. If necessary, restart the computer's firewall. You have successfully changed the IP address, subnet mask, and gateway.

IP setting using SetIP Program (Linux)

SetIP program should be automatically installed during the printer driver installation.

1. Print the machine's network configuration report to find your machine's MAC address.
2. Open the `/opt/Samsung/mfp/share/utills/`.
3. Double click the **SetIPApplet.html** file.
4. Click to open the TCP/IP configuration window.
5. Enter the network card's MAC address, IP address, subnet mask, default gateway, and then click **Apply**.
 -  When you enter the MAC address, enter it without a colon(:).
6. The machine prints the network information. Confirm all the settings are correct.
7. Close the SetIP program.

Network parameter setting

You can also set up the various network settings through the network administration programs such as **SyncThru™ Web Admin Service** and **SyncThru™ Web Service**.

Restoring factory default settings

You may need to reset the machine to the factory default settings when machine that you are using is connected to new network environment.

Restoring factory default settings using SyncThru™ Web Service

1. Start a web browser such as Internet Explorer, Safari or Firefox and enter your machine's new IP address in the browser window. For example,

```
http://192,168,1,133/
```
2. When the **SyncThru™ Web Service** window opens, click **Network Settings**.

3. Click **Reset**. Then, click **Clear** for network.

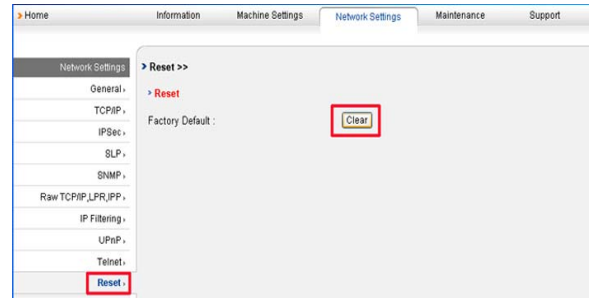

4. Turn off and restart machine to apply settings.

INSTALLING NETWORK CONNECTED MACHINE'S DRIVER

Windows

You can set up the machine driver, follow the steps below.

This is recommended for most users. All components necessary for machine operations will be installed.

1. Make sure that the machine is connected to the network or USB and powered on.
2. Insert the supplied software CD into your CD-ROM drive.
 - The software CD should automatically run and an installation window appear.
 - If the installation window does not appear, click **Start** and then **Run**. Type `X:\Setup.exe`, replacing "X" with the letter which represents your drive. Click **OK**.
 - If you use Windows Vista, click **Start > All programs > Accessories > Run**. Type `X:\Setup.exe` replacing "X" with the letter which represents your drive and click **OK**.
 - If the **AutoPlay** window appears in Windows Vista, click **Run Setup.exe** in **Install or run program** field, and click **Continue** in the **User Account Control** windows.
3. Select **Install now**.

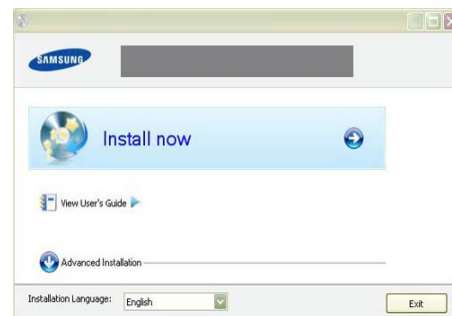

If necessary, select a language from the drop-down list.

-  The **Advanced Installation** has two options, **Custom Installation** and **Install Software Only**. The **Custom Installation** allows you to select the machine's connection and choose individual component to install. The **Install Software Only** allows you to

install the supplied softwares, such as Smart Panel. Follow the guide on the window.

4. Read **License Agreement**, and select **I accept the terms of the License Agreement**. Then, click **Next**.

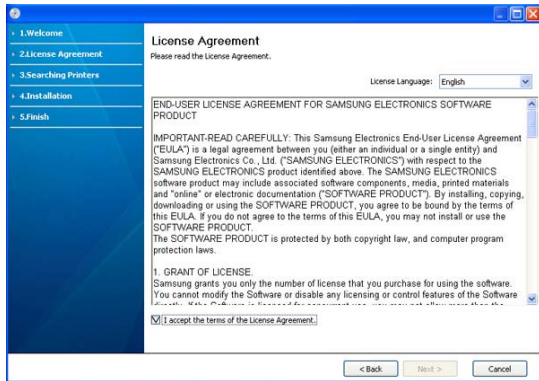

The program searches the machine.

 If your machine is not found in the network or locally, the following window will appear.

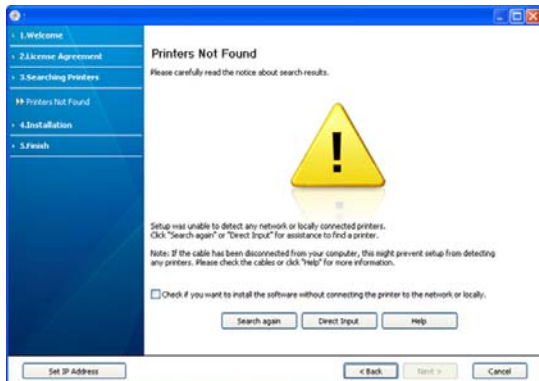

- **Check if you want to install the software without connecting the printer to the network or locally.**
 - Check this option to install this program without a machine connected. In this case, the print a test page window will be skipped, and completes the installation.

• **Search again**

When you press this button, the firewall notice window appears;

- Turn off the firewall and **Search again**. For Window operating system, click **Start > Control Panel > Windows Firewall**, and inactivate this option. For other operating system, refer to its on-line guide.
- Turn off the firewall from the third party's program beside the operating system. Refer to the manual provided by individual programs.

• **Direct Input**

The **Direct Input** allows you to search a specific machine on the network.

- **Search by IP address:** Enter the IP address or the host name. Then click **Next**.

To verify your machine's IP address, print a network configuration report. (See "Printing network configuration report" on page 28.)

- **Search by network path:** To find a shared machine (UNC Path), enter the shared name manually or find a shared printer by clicking the **Browse** button. Then click **Next**.

• **Help**

If your machine is not connected to the computer or network, This help button gives detailed information about the how to connect the machine.

• **Set IP Address**

If you want to set a specific IP address on a specific network machine, click the **Set IP Address** button. The **Set IP Address** window appears. Do as follows:

- Select a machine to be set with a specific IP address from the list.
- Configure an IP address, subnet mask, and gateway for the machine manually and click **Apply** to set the specific IP address for the network machine.
- Click **Next**.

- The searched machine will be shown on the screen. Select one you wish to use.

 If the driver searched only one printer, the confirmation window appears.

The program starts installation.

- After the installation is finished, a window asking you to print a test page appears. If you want to print a test page, click **Print a test page**. Otherwise, just click **Next** and skip to step 7.
- If the test page prints out correctly, click **Yes**. If not, click **No** to reprint it.
- To register as a user of the machine in order to receive information from Samsung, click **On-line Registration**. You are now registered to the Samsung web site.





- Click **Finish**.

 • After the driver setup, you may enable firewalls.

• If your printer driver doesn't work properly after setup has been completed, repair or reinstall the printer driver. (See "Installing USB connected machine's driver" on page 24.)

Macintosh

1. Make sure that the machine is connected to your network and powered on. Also, your machine's IP address should have been set.
2. Insert the supplied software CD into your CD-ROM drive.
3. Double-click the CD-ROM icon that appears on your Macintosh desktop.
4. Double-click the **MAC_Installer** folder.
5. Double-click the **Installer OS X** icon.
6. Enter the password and click **OK**.
7. The Samsung Installer window opens. Click **Continue**.
8. Select **Easy Install** and click **Install**. **Easy Install** is recommended for most users. All components necessary for machine operations will be installed.
 - If you select **Custom Install**, you can choose individual components to install.
9. The message which warns that all applications will close on your computer appears. Click **Continue**.
10. After the installation is finished, click **Quit**.
11. Open the **Applications** folder > **Utilities** > **Print Setup Utility**.
 - For Mac OS X 10.5~10.6, open the **Applications** folder > **System Preferences** and click **Print & Fax**.
12. Click **Add** on the **Printer List**.
 - For Mac OS X 10.5~10.6, click the "+" icon; a display window will pop up.
13. For Mac OS X 10.3, select the **IP Printing** tab.
 - For Mac OS X 10.4, click **IP Printer**.
 - For Mac OS X 10.5~10.6, click **IP**.
14. Select **Socket/HP Jet Direct** in **Printer Type**.
 -  When printing a document containing many pages, printing performance may be enhanced by choosing **Socket** for **Printer Type** option.
15. Enter the machine's IP address in the **Printer Address** field.
16. Enter the queue name in the **Queue Name** field. If you cannot determine the queue name for your machine server, try using the default queue first.
17. For Mac OS X 10.3, if Auto Select does not work properly, select **Samsung** in **Printer Model** and your machine name in **Model Name**.
 - For Mac OS X 10.4, if Auto Select does not work properly, select **Samsung** in **Print Using** and your machine name in **Model**.
 - For Mac OS X 10.5~10.6, if Auto Select does not work properly, select **Select a driver to use...** and your machine name in **Print Using**.Your machine appears on the **Printer List**, and is set as the default machine.
18. Click **Add**.
 -  If the printer driver does not work properly, uninstall the driver and reinstall it.
Follow steps below to uninstall the driver for Macintosh.
 - a) Make sure that the machine is connected to your computer and powered on.
 - b) Insert the supplied software CD into your CD-ROM drive.
 - c) Double-click CD-ROM icon that appears on your Macintosh desktop.
 - d) Double-click the **MAC_Installer** folder.
 - e) Double-click the **Installer OS X** icon.
 - f) Enter the password and click **OK**.

- g) The Samsung Installer window opens. Click **Continue**.
- h) Select **Uninstall** and click **Uninstall**.
- i) When the message which warns that all applications will close on your computer appears, Click **Continue**.
- j) When the uninstall is done, click **Quit**.

Linux

1. Make sure that the machine is connected to your network and powered on. Also, your machine's IP address should have been set.
2. Insert the supplied software CD into your CD-ROM drive.
3. Double-click CD-ROM icon that appears on your Linux desktop.
4. Double-click the **Linux** folder.
5. Double-click the **install.sh** icon.
6. The Samsung Installer window opens. Click **Continue**.
7. The Add printer wizard window opens. Click **Next**.
8. Select Network printer and click **Search** button.
9. The Printer's IP address and model name appears on list field.
10. Select your machine and click **Next**.

IPv6 CONFIGURATION



TCP/IPv6 is supported properly only in Windows Vista or higher.



If the IPv6 network seems not working, set all the network setting to the factory defaults and try again. (See "Restoring factory default settings" on page 30.)

To use the IPv6 network environment, follow the next procedure to use the IPv6 address:

The machine is provided with IPv6 feature on.

1. Connect your machine to the network with a network cable.
 2. Turned on the machine.
 3. Print a **Network Configuration Report** from the machine's control panel that will check IPv6 addresses.
 4. Select **Start > Control Panel > Hardware and Sound > Printers > Add Printer**.
 5. Click **Add a local printer** on the **Add Printer** windows.
 6. Follow the instruction on the window.
-  If the machine does not work in the network environment, activate IPv6. Refer to the next section followed by.

Printing network configuration report

You can print a **Network Configuration Report** from the machine's control panel that will show the current machine's network settings. This will help you to set up a network and troubleshooting problems.

To print the report:

In ready mode, press and hold the Ⓞ (cancel button) for about 5 seconds. You can find your machine's MAC address and IP address.

For example:

- MAC Address : 00:15:99:41:A2:78
- IP Address : 192.0.0.192

Setting IPv6 addresses

Machine supports following IPv6 addresses for network printing and managements.

- **Link-local Address:** Self-configured local IPv6 address. (Address starts

with FE80.)

- **Stateless Address:** Automatically configured IPv6 address by a network router.
- **Stateful Address:** IPv6 address configured by a DHCPv6 server.
- **Manual Address:** Manually configured IPv6 address by a user.

Manual address configuration

1. Start a web browser such as Internet Explorer that supports IPv6 addressing as a URL. (See "Using SyncThru™ Web Service (ML-2580 Series only)" on page 49.)



For IPv4, enter the IPv4 address (http://xxx.xxx.xxx.xxx) in the address field and press the Enter key or click **Go**.

2. When the **SyncThru™ Web Service** window opens, click **Network Settings**.
3. Click **TCP/IP**.

The screenshot shows the 'Network Settings' page with the 'TCP/IPv6' section expanded. The 'Manual Address' section is highlighted with a red box. It includes a 'Manual Address' checkbox (checked), a 'Router Prefix' dropdown menu (set to '3FFE:10:88:194::/64'), an 'Add' button, and a text input field containing '3FFE:10:88:194::' followed by a slash and '64'. Other settings like 'Link-Local Address', 'Global Address', and 'DHCPv6 Address' are also visible.

4. Enable the **Manual Address** in the **TCP/IPv6** section.
5. Select the **Router Prefix** and click the **Add** button, then the router prefix will automatically be entered into the address field.
Enter the rest of address. (ex:3FFE:10:88:194::**AAAA**. "A" is the hexadecimal 0 through 9, A through F.)
6. Click the **Apply** button.

Installing printer driver

Driver installation for network printer in IPv6 network environment is same as TCP/IPv4. (See "Installing network connected machine's driver" on page 30.)

Select TCP/IP Port and when the list of machines are displayed, simply select your machine's IPv6 address.

Using SyncThru Web Service

1. Start a web browser such as Internet Explorer that supports IPv6 addressing as a URL .
2. Select one of the IPv6 addresses (**Link-local Address, Stateless Address, Stateful Address, Manual Address**) from **Network Configuration Report**.
3. Enter the IPv6 addresses. (ex: http://[FE80::215:99FF:FE66:7701])



Address must be enclosed in '[''] brackets.

basic setup

After installation is complete, you may want to set the machine's default settings. Refer to the next section if you would like to set or change values. This chapter gives you step-by-step instructions for setting up the machine.

This chapter includes:

- Altitude adjustment (ML-2580 Series only)
- Setting the default tray and paper
- Changing font setting (ML-2580 Series only)

ALTITUDE ADJUSTMENT (ML-2580 SERIES ONLY)

The print quality is affected by atmospheric pressure, which is determined by the height of the machine above sea level. The following information will guide you on how to set your machine to the best print quality or best quality of print.

Before you set the altitude value, find the altitude where you are using the machine.

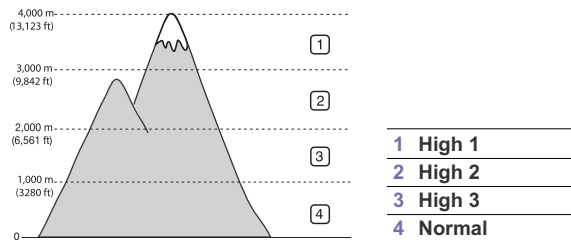

1. Ensure that you have installed the printer driver with the provided Printer Software CD.
2. Double-click the **Smart Panel** icon on the Windows task bar (or Notification Area in Linux). You can also click **Smart Panel** on the status bar in Mac OS X.
Or, if you are a Windows user, you can launch it from the **Start** menu, select **Programs** or **All Programs** > **Samsung Printers** > **your printer driver name** > **Smart Panel**.
3. Click **Printer Setting**.
4. Click **Setting** > **Altitude Adjustment**. Select the appropriate value from the dropdown list, and then click **Apply**.

If your machine is connected to a network, SyncThru™ Web Service screen appears automatically. Click **Machine Settings** > **Setup** > **Altitude Adj.** Select the appropriate altitude value, and then click **Apply**.

SETTING THE DEFAULT TRAY AND PAPER

You can select the tray and paper you would like to keep using for printing job.

In the computer

Windows

1. Click the Windows **Start** menu.
2. For Windows 2000, select **Settings** > **Printers** .
 - For Windows XP/2003 select **Printer and Faxes**.
 - For Windows 2008/Vista select **Control Panel** > **Hardware and Sound** > **Printers**.
3. Right-click your machine and press **Printing Preferences**.
4. Click **Paper** tab.
5. Select tray and its options, such as paper size and type.
6. Press **OK**.

If you want to use special-sized paper-such as a billing paper, select **Edit...** in the **Paper** tab in the **Printing Preferences**. (See "Opening printing preferences" on page 42.)

Macintosh

Macintosh does not support this function. Macintosh users need to change the default setting manually each time they want to print using other settings.

1. Open a Macintosh application and select the file you want to print.
2. Open the **File** menu and click **Print**.
3. Go to **Paper Feed** pane.
4. Open the **File** menu and click **Print**.
5. Go to **Paper Feed**.
6. Set appropriate tray from which you want to print.
7. Go to **Paper** pane.
8. Set paper type to correspond to the paper loaded in the tray from which you want to print.
9. Click **Print** to print.

CHANGING FONT SETTING (ML-2580 SERIES ONLY)

Your machine has preset font setting depending on your region or country.

If you want to change the font or set the font for special condition, such as the DOS environment, you can change the font setting as follows:

1. Ensure that you have installed the printer driver with the provided Printer Software CD.
2. Double-click the **Smart Panel** icon on the Windows task bar (or Notification Area in Linux). You can also click **Smart Panel** on the status bar in Mac OS X.

Or, if you are a Windows user, you can launch it from the **Start** menu,

select **Programs** or **All Programs** > **Samsung Printers** > **your printer driver name** > **Smart Panel**.

3. Click **Printer Setting**.
4. Click **Emulation**.
5. Confirm if **PCL** is selected in **Emulation Setting**.
6. Click **Setting**.
7. Select your preferred font in the **Symbol** set list.
8. Click **Apply**.



Following information shows the proper font list for corresponding languages.

- **Russian:** CP866, ISO 8859/5 Latin Cyrillic
- **Hebrew:** Hebrew 15Q, Hebrew-8, Hebrew-7 (Israel only)
- **Greek:** ISO 8859/7 Latin Greek, PC-8 Latin/Greek
- **Arabic & Farsi:** HP Arabic-8, Windows Arabic, Code Page 864, Farsi, ISO 8859/6 Latin Arabic
- **OCR:** OCR-A, OCR-B

media and tray

This chapter provides information on how to load print media into your machine.

This chapter includes:

- Selecting print media
- Changing the tray size
- Loading paper in the tray
- Printing on special media
- Using the output support

SELECTING PRINT MEDIA

You can print on a variety of print media, such as plain paper, envelopes, labels, and transparencies. Always use print media that meet the guidelines for use with your machine.

Guidelines to select the print media

Print media that does not meet the guidelines outlined in this user's guide may cause the following problems:

- Poor print quality
- Increased paper jams
- Premature wear on the machine.

Properties, such as weight, composition, grain, and moisture content, are important factors that affect the machine's performance and the output quality. When you choose print materials, consider the following:

- The type, size and weight of the print media for your machine are described in print media specifications. (See "Print media specifications" on page 69.)
- Desired outcome: The print media you choose should be appropriate for your project.
- Brightness: Some print media are whiter than others and produce sharper, more vibrant images.
- Surface smoothness: The smoothness of the print media affects how crisp the printing looks on the paper.

- Some print media may meet all of the guidelines in this section and still not produce satisfactory results. This may be the result of improper handling, unacceptable temperature and humidity levels, or other variables over which cannot be controlled.
- Before purchasing large quantities of print media, ensure that it meets the requirements specified in this user's guide.

Using print media that does not meet these specifications may cause problems, requiring repairs. Such repairs are not covered by the warranty or service agreements.

The amount of paper put into the tray may differ according to media type used. (See "Print media specifications" on page 69.)

Media sizes supported in each mode

MODE	SIZE	TYPE	SOURCE
Simplex printing	For details about paper size, see "Print media specifications" on page 69.	For details about paper type, see "Print media specifications" on page 69.	<ul style="list-style-type: none">• tray 1• manual tray
Duplex printing (Manual)^a	Letter, A4, Legal, US Folio, Oficio	Plain, Color, Preprinted, Recycled, Bond, Archive	<ul style="list-style-type: none">• tray 1• manual tray

a. 75 to 90 g/m² (20~24 lb bond) only

CHANGING THE TRAY SIZE

The tray is preset to Letter or A4 size, depending on your country. To change the size, you need to adjust the paper guides.

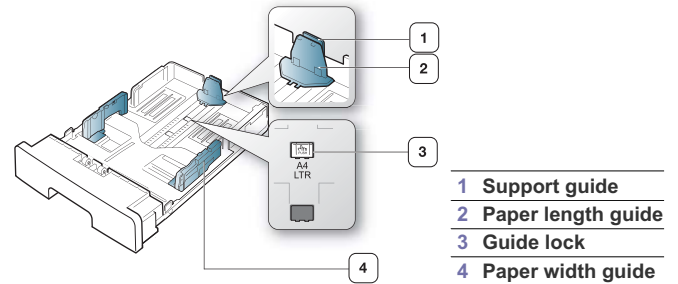

1. With one hand press and hold the guide lock, and with the other hand, hold the paper length guide and support guide together. Slide the paper length guide and support guide to locate them in the correct paper size slot.

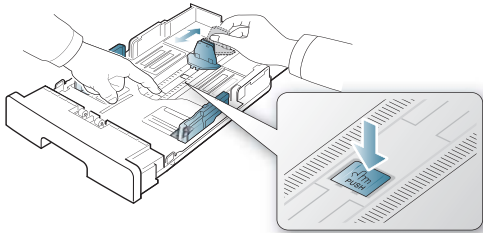

2. Flex or fan the edge of the paper stack to separate the pages before loading papers. Insert the paper into the tray.

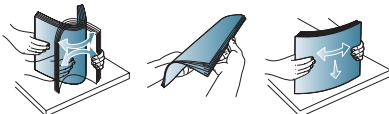

3. After inserting paper into the tray, adjust the support guide so that it lightly touches the paper stack.

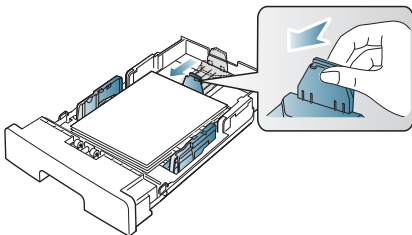

4. Squeeze the paper width guides and slide them to the desired paper size marked at the bottom of the tray.

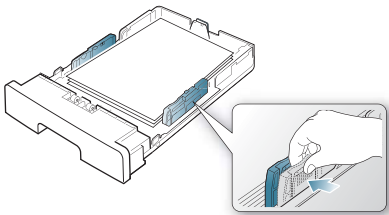

- Do not push the paper width guide too far causing the media to warp.
- If you do not adjust the paper width guide, it may cause paper jams.

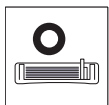

LOADING PAPER IN THE TRAY

Tray 1

1. Pull out the paper tray . And adjust the tray size to the media size you are loading. (See "Changing the tray size" on page 36.)
2. Flex or fan the edge of the paper stack to separate the pages before loading papers.

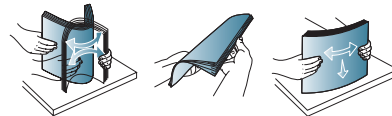

3. And place paper with the side you want to print facing down.

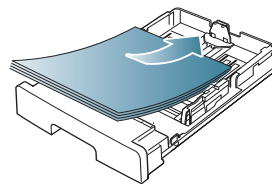

4. Set the paper type and size for the tray 1. (See "Setting the default tray and paper" on page 34.)

- If you experience problems with paper feeding, check whether the paper meets the media specification. Then try placing one sheet at a time in the manual tray. (See "Print media specifications" on page 69.)

Manual tray

The manual tray can hold special sizes and types of print material, such as postcards, note cards, and envelopes. It is useful for single page printing on letterhead or colored paper.

Tips on using the manual tray

- If you select **Manual Feeder** for **Source** from your software application, you need to press  (cancel button) each time you print a page and load only one type, size and weight of print media at a time in the manual tray.
- To prevent paper jams, do not add paper while printing when there is still paper in the manual tray. This also applies to other types of print media.
- Print media should be loaded face up with the top edge going into the manual tray first and be placed in the center of the tray.
- Always load the specified print media only to avoid paper jams and print quality problems. (See "Print media specifications" on page 69.)
- Flatten any curl on postcards, envelopes, and labels before loading them into the manual tray.

1. Load the paper in the manual tray.

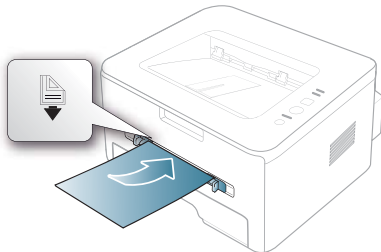

- Do not force the paper beyond the surface with the mark when loading.
 - When printing the special media, you must follow the loading guideline. (See "Printing on special media" on page 38.)
 - When papers overlap when printing using manual tray, open tray 1 and remove overlapping papers then try printing again.
 - When paper does not feed well while printing, push the paper in manually until it starts feeding automatically.
2. Squeeze the manual tray paper guides and adjust them to the width of the paper. Do not force them too much, or the paper will bent resulting in a paper jam or skew.
 3. To print in application, open an application and start the print menu.
 4. Open **Printing Preferences**. (See "Opening printing preferences" on page 42.)
 5. Press the **Paper** tab in **Printing Preferences**, and select an appropriate paper type.
 - For example, if you want to use a label, set the paper type to **Label**.
 6. Select **Manual Feeder** in paper source, then press **OK**.
 7. Start printing in application.
 - If you are printing multiple pages, load the next sheet after the first page prints out, and press the **⊘** (cancel button). Repeat this step for every page to be printed.

PRINTING ON SPECIAL MEDIA

The table below shows the available special media for each tray.

- When using special media, we recommend you feed one paper at a time. Check the maximum input number of media for each tray. (See "Print media specifications" on page 69.)

TYPES	TRAY 1	MANUAL TRAY
Plain	○	○
Thick	○	○
Thin	○	○
Bond	X	○
Color	X	○
CardStock	X	○

TYPES	TRAY 1	MANUAL TRAY
Labels	X	○
Transparency	X	○
Envelope	X	○
Preprinted	X	○
Cotton	X	○
Recycled	○	○
Archive	○	○

The media types are shown in the **Printing Preferences**. This paper type option allows you to set the type of paper to be loaded in the tray. This setting appears in the list, so that you can select it. This will let you get the best quality printout. If not, the desired print quality may not be achieved.

- **Plain:** Normal plain paper. Select this type if your machine is monochrome and printing on the 60 g/m² (16 lb) cotton paper.
- **Thick:** 90 to 105 g/m² (24 to 28 lb) thick paper.
- **Thin:** 60 to 70 g/m² (16 to 19 lb) thin paper.
- **Bond:** 105 to 120 g/m² (28 to 32 lb) bond.
- **Color:** 75 to 90 g/m² (20 to 24 lb) color-backgrounded paper.
- **CardStock:** 90 to 163 g/m² (24 to 43 lb) cardstock.
- **Labels:** 120 to 150 g/m² (32 to 40 lb) labels.
- **Transparency:** 138 to 146 g/m² (37 to 39 lb) transparency paper.
- **Envelope:** 75 to 90 g/m² (20 to 24 lb) envelope.
- **Preprinted:** 75 to 90 g/m² (20 to 24 lb) preprinted/letterhead paper.
- **Cotton:** 75 to 90 g/m² (20 to 24 lb) preprinted paper.
- **Recycled:** 75 to 90 g/m² (20 to 24 lb) recycled paper.
- **Archive:** 70 to 90 g/m² (19 to 24 lb) If you need to keep the print-out for a long period time, such as archives, select this option.

Envelope

Successful printing on envelopes depends upon the quality of the envelopes.

To print an envelope, place it flap side down with the stamp area on the bottom right side.

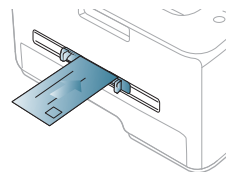

If envelopes are printed out with wrinkles, crease or black bold lines, open the rear cover and pull down the pressure lever and try printing again. Keep the rear cover opened during printing.

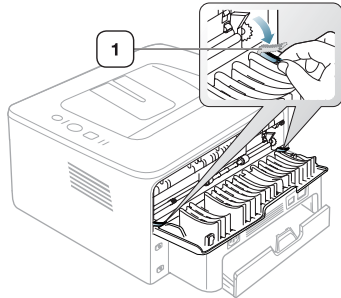

1 Pressure lever

- When selecting envelopes, consider the following factors:
 - Weight:** The weight of the envelope paper should not exceed 90 g/m² otherwise, jam may occur.
 - Construction:** Prior to printing, envelopes should lie flat with less than 6 mm curl, and should not contain air.
 - Condition:** Envelopes should not be wrinkled, nicked, nor damaged.
 - Temperature:** Use envelopes that are compatible with the heat and pressure of the machine during operation.
- Use only well-constructed envelopes with sharp-and well-creased folds.
- Do not use stamped envelopes.
- Do not use envelopes with clasps, snaps, windows, coated lining, self-adhesive seals, or other synthetic materials.
- Do not use damaged or poorly made envelopes.
- Be sure the seam at both ends of the envelope extends all the way to the corner of the envelope.

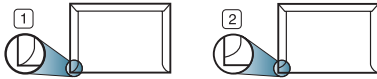

- 1 Acceptable
- 2 Unacceptable

- Envelopes with a peel-off adhesive strip or with more than one flap that folds over to seal must use adhesives compatible with the machine's fusing temperature for 0.1 second. To view the fusing temperature, check your machine's specification. (See "General specifications" on page 67.) The extra flaps and strips might cause wrinkling, creasing, or jams, and may even damage the fuser.
- For the best print quality, position margins no closer than 15 mm from the edges of the envelope.
- Avoid printing over the area where the envelope's seams meet.

Transparency

To avoid damaging the machine, use only transparencies designed for use in laser printers.

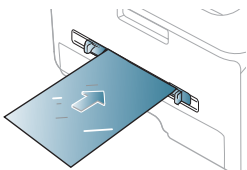

- Transparencies used in the machine must be able to withstand machine's fusing temperature.
- Place them on a flat surface after removing them from the machine.
- Do not leave unused transparencies in the paper tray for long periods of time. Dust and dirt may accumulate on them, resulting in spotty printing.
- To avoid smudging caused by fingerprints, handle them carefully.
- To avoid fading, do not expose printed transparencies to prolonged sunlight.
- Ensure that transparencies are not wrinkled, curled, or have any torn edges.
- Do not use transparencies that separates from the backing sheet.
- To prevent transparencies from sticking to each other, do not let the printed sheets stack up as they are begin printed out.
- Recommended media: Transparency for a color laser printer by Xerox, such as 3R 91331 (A4), 3R 2780 (Letter)

Labels

To avoid damaging the machine, use only labels designed for use in laser machines.

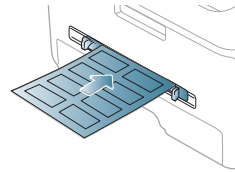

- When selecting labels, consider the following factors:
 - Adhesives:** The adhesive material should be stable at your machine's fusing temperature. Check your machine's specification to view the fusing temperature. (See "General specifications" on page 67.)
 - Arrangement:** Only use labels with no exposed backing between them. Labels can peel off sheets that have spaces between the labels, causing serious jams.
 - Curl:** Prior to printing, labels must lie flat with no more than 13 mm of curl in any direction.
 - Condition:** Do not use labels with wrinkles, bubbles, or other indications of separation.
- Make sure that there is no exposed adhesive material between labels. Exposed areas can cause labels to peel off during printing, which can cause paper jams. Exposed adhesive can also cause damage to machine components.
- Do not run a sheet of labels through the machine more than once. The adhesive backing is designed for only a single pass through the machine.
- Do not use labels that are separating from the backing sheet or are wrinkled, bubbled, or otherwise damaged.

Card stock/ Custom-sized paper

Postcards, cards and other custom-sized materials can be printed with this machine.

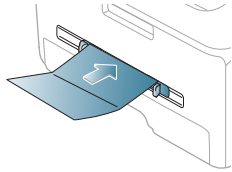

- Do not print on media smaller than 76 mm (3.00 inches) wide or 127 mm (5.00 inches) long.
- In the software application, set margins at least 6.4 mm (0.25 inches) away from the edges of the material.

Letterhead/ Preprinted paper

	SINGLE-SIDED	DOUBLE-SIDED
Tray1	<p>Face down</p>	<p>Face up</p>
Manual tray	<p>Face up</p>	<p>Face down</p>

- Letterhead/ Preprinted paper must be printed with heat-resistant ink that will not melt, vaporize, or release hazardous emissions when subjected to the machine's fusing temperature for 0.1 second. Check your machine's specification to view the fusing temperature. (See "General specifications" on page 67.)
- Letterhead/ Preprinted paper ink must be non-flammable and should not adversely affect machine rollers.
- Forms and letterhead should be sealed in a moisture-proof wrapping to prevent changes during storage.
- Before you load letterhead/preprinted paper, verify that the ink on the paper is dry. During the fusing process, wet ink can come off preprinted paper, reducing print quality.

Photo

- Make sure not to use the inkjet photo paper with this machine. It could cause damage to the machine.

Glossy

 Load one paper to the manual tray at a time, glossy side facing up.

- Recommended media: Glossy paper (Letter) for this machine by **HP Brochure Paper** (Product: Q6611A) only.
- Recommended media: Glossy paper (A4) for this machine by **HP Superior Paper 160 glossy** (Product: Q6616A).

USING THE OUTPUT SUPPORT

 The surface of the output tray may become hot if you print a large number of pages at once. Make sure that you do not touch the surface, and do not allow children near it.

The printed pages stack on the output support, and the output support will help the printed pages to align. The printer sends output to the output tray by default. To use the output tray, make sure that the rear cover is closed.

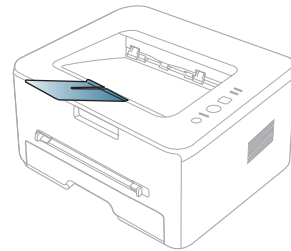

printing

This chapter explains common printing tasks.

This chapter includes:

- Printer driver features
- Basic printing
- Opening printing preferences
- Using help
- Using special print features

 The procedures in this chapter are mainly based on Windows XP.

PRINTER DRIVER FEATURES

Your printer drivers support the following standard features:

- Paper orientation, size, source, and media type selection
- Number of copies

In addition, you can use various special printing features. The following table shows a general overview of features supported by your printer drivers:

 Some models or operating system may not support the certain feature(s) in the following table.

Printer driver





FEATURE	WINDOWS
Machine quality option	<input type="radio"/>
Poster printing	<input type="radio"/>
Multiple pages per sheet	<input type="radio"/>
Booklet printing (manual)	<input type="radio"/>
Fit to page printing	<input type="radio"/>
Reduce and enlarge printing	<input type="radio"/>
Different source for first page	<input type="radio"/>
Watermark	<input type="radio"/>
Overlay	<input type="radio"/>
Double-sided printing (manual)	<input type="radio"/>

BASIC PRINTING

Your machine allows you to print from various Windows, Macintosh, or Linux applications. The exact steps for printing a document may vary depending on the application you use.

 • Your **Printing Preferences** window that appears in this user's guide may differ depending on the machine in use. However, the composition of the **Printing Preferences** window is similar. Check the operating system(s) that are compatible with your machine. Refer to the OS compatibility section of Printer Specifications. (See "Printer specifications" on page 68.)

- Changing the default print settings
- Setting your machine as a default machine
- Printing to a file (PRN)
- Macintosh printing
- Linux printing

- When you select an option in **Printing Preferences**, you may see a warning mark, , or . An exclamation mark () means you can select that certain option but it is not recommended, and () mark means you cannot select that option due to the machine's setting or environment.

The following procedure describes the general steps required for printing from various Windows applications.

-  Macintosh basic printing. (See "Macintosh printing" on page 46.)
- Linux basic printing. (See "Linux printing" on page 47.)

The following **Printing Preferences** window is for Notepad in Windows XP. Your **Printing Preferences** window may differ, depending on your operating system or the application you are using.

1. Open the document you want to print.
2. Select **Print** from the **File** menu. The **Print** window appears.
3. Select your machine from the **Select Printer** list.

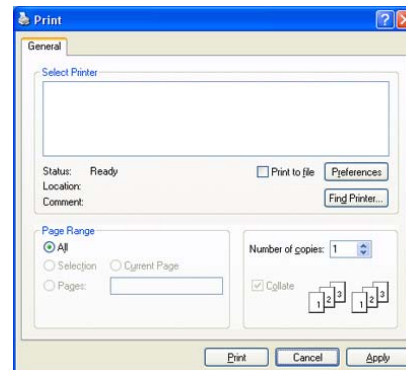

The basic print settings including the number of copies and print range are selected within the **Print** window.

 To take advantage of the printer features provided by your printer driver, click **Properties** or **Preferences** in the application's **Print** window to change the print setting. (See "Opening printing preferences" on page 42.)



4. To start the print job, click **OK** or **Print** in the **Print** window.

 If you are using Windows Internet Explorer, the **AnyWeb Print** tool will save your time for screen-captured images or printing the image. Click **Start > All programs > Samsung Printers > your machine name > AnyWeb Print** to link the website where the tool is available for the download.

Canceling a print job

If the print job is waiting in a print queue or print spooler, cancel the job as follows:

1. Click the Windows **Start** menu.
 - For Windows 2000, select **Settings > Printers**.
 - For Windows XP/2003, select **Printers and Faxes**.
 - For Windows 2008/Vista, select **Control Panel > Hardware and Sound > Printers**.
2. Double-click your machine.
3. From the **Document** menu, select **Cancel**.

 You can also access this window by simply double-clicking the machine icon () in the Windows task bar.

You can also cancel the current job by pressing  on the control panel.

OPENING PRINTING PREFERENCES

You can preview the settings you selected on the upper right of the **Printing Preferences**.

1. Open the document you want to print.
2. Select **Print** from the file menu. The **Print** window appears.
3. Select your machine from the **Select Printer**.
4. Click **Properties** or **Preferences**.

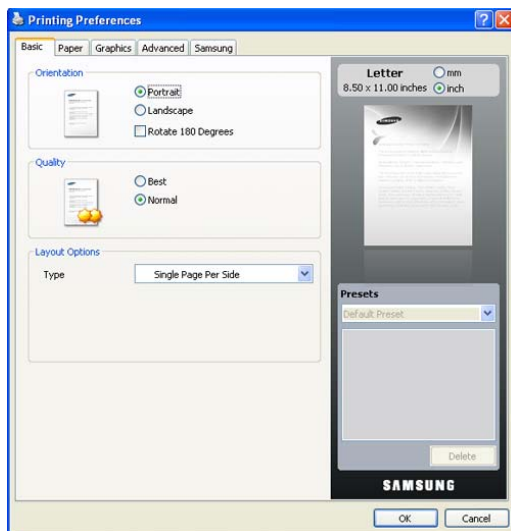

Using a favorite setting

The **Presets** option, which is visible on each preferences tab except for **Samsung** tab, allows you to save the current preferences settings for future use.

To save a **Presets** item:

1. Change the settings as needed on each tab.
2. Enter a name for the item in the **Presets** input box. Click **Save**.

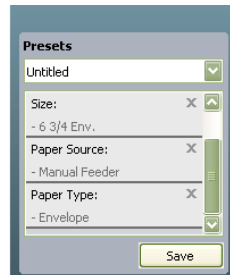

3. When you save **Presets**, all current driver settings are saved.

To use a saved setting, select it from the **Presets** drop down list. The machine is now set to print according to the setting you selected.

To delete saved setting, select it from the **Presets** drop down list and click **Delete**.

You can also restore the printer driver's default settings by selecting **Default Preset** from the **Presets** drop down list.

USING HELP

Click the question mark from the upper-right corner of the window and click on any option you want to know about. Then a pop up window appears with information about that option's feature which is provided from the driver.



If you want to search information via a keyword, click the **Samsung** tab in the **Printing Preferences** window, and enter a keyword in the input line of the **Help** option. To get information about supplies, driver update or registration and so on, click appropriate buttons.

USING SPECIAL PRINT FEATURES

Special print features include:

- "Printing multiple pages on one sheet of paper" on page 42.
- "Printing posters" on page 43.
- "Printing booklets (Manual)" on page 43.
- "Printing on both sides of paper (Manual)" on page 43.
- "Change percentage of your document" on page 44.
- "Fitting your document to a selected paper size" on page 44.
- "Using watermarks" on page 44.
- "Using overlay" on page 44.
- "Advanced Options" on page 45.

Printing multiple pages on one sheet of paper

You can select the number of pages to print on a single sheet of paper. To print more than one page per sheet, the pages will be reduced in size and arranged in the order you specify. You can print up to 16 pages on one sheet.

1. To change the print settings from your software application, access **Printing Preferences**. (See "Opening printing preferences" on page 42.)
2. Click the **Basic** tab, select **Multiple Pages Per Side** in the **Type** drop-down list.
3. Select the number of pages you want to print per sheet (2, 4, 6, 9, or 16) in the **Pages per Side** drop-down list.
4. Select the page order from the **Page Order** drop-down list, if necessary.
5. Check **Print Page Border** to print a border around each page on the sheet.
6. Click the **Paper** tab, select the **Size**, **Source**, and **Type**.
7. Click **OK** or **Print** until you exit the **Print** window.

Printing posters

This feature allows you to print a single-page document onto 4, 9, or 16 sheets of paper, for the purpose of pasting the sheets together to form one poster-size document.

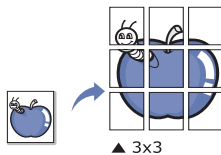

1. To change the print settings from your software application, access **Printing Preferences**. (See "Opening printing preferences" on page 42.)
2. Click the **Basic** tab, select **Poster Printing** in the **Type** drop-down list.
3. Select the page layout you want.
Specification of the page layout:
 - **Poster 2x2**: Document will be enlarged and be divided into 4 pages.
 - **Poster 3x3**: Document will be enlarged and be divided into 9 pages.
 - **Poster 4x4**: Document will be enlarged and be divided into 16 pages.
4. Select the **Poster Overlap** value. Specify **Poster Overlap** in millimeters or inches by selecting the radio button on the upper right of **Basic** tab to make it easier to paste the sheets together.

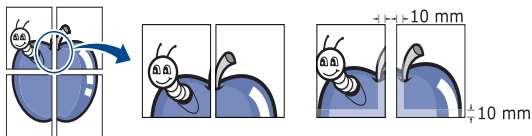

5. Click the **Paper** tab, select the **Size**, **Source**, and **Type**.
6. Click **OK** or **Print** until you exit the **Print** window.
7. You can complete the poster by pasting the sheets together.



Printing booklets (Manual)

This feature prints your document on both sides of a paper and arranges the pages so that the paper can be folded in half after printing to produce a booklet.

-  If you want to make a booklet, you need to print on Letter, Legal, A4,

US Folio, or Oficio sized print media.



1. To change the print settings from your software application, access the **Printing Preferences**. (See "Opening printing preferences" on page 42.)
2. Click the **Basic** tab, select **Booklet Printing** from the **Type** drop-down list.
3. Click the **Paper** tab, select the **Size**, **Source**, and **Type**.
 The **Booklet Printing** option is not available for all paper sizes. In order to find out the available paper size for this feature, select the available paper size in the **Size** option on the **Paper** tab.
If you select an unavailable paper size, this option can be automatically canceled. Select only available paper. (paper without  or  mark).
4. Click **OK** or **Print** until you exit the **Print** window.
5. After printing, fold and staple the pages.

Printing on both sides of paper (Manual)

You can print on both sides of a paper; duplex. Before printing, decide how you want your document oriented. You can use this feature with Letter, Legal, A4, US Folio, or Oficio sized paper. (See "Print media specifications" on page 69.)

-  We recommend not to print on both sides of the special media, such as labels, envelopes, or thick paper to print on both sides of paper. It may cause a paper jam or damage the machine.

1. To change the print settings from your software application, access **Printing Preferences**. (See "Opening printing preferences" on page 42.)
2. Click the **Advance** tab.
3. From the **Double-Sided Printing (Manual)** section, select the binding option you want.
 - **None**
 - **Long Edge**: This option is the conventional layout used in bookbinding.



- **Short Edge**: This option is the conventional layout used in calendars.



4. Click the **Paper** tab, select the **Size**, **Source**, and **Type**.
5. Click **OK** or **Print** until you exit the **Print** window.

-  If your machine does not have a duplex unit, you should complete the printing job manually. The machine prints every other page of the document first. After that, a message appears on your computer. Follow the on-screen instructions to complete the printing job.

Change percentage of your document

You can change the size of a document to appear larger or smaller on the printed page by typing in a percentage you want.



1. To change the print settings from your software application, access **Printing Preferences**. (See "Opening printing preferences" on page 42.)
2. Click the **Paper** tab.
3. Enter the scaling rate in the **Percentage** input box.
You can also click the up/down arrows to select the scaling rate.
4. Select the **Size**, **Source**, and **Type** in **Paper Options**.
5. Click **OK** or **Print** until you exit the **Print** window.

Fitting your document to a selected paper size

This printer feature allows you to scale your print job to any selected paper size regardless of the document size. This can be useful when you want to check fine details on a small document.

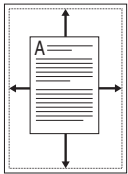

1. To change the print settings from your software application, access **Printing Preferences**. (See "Opening printing preferences" on page 42.)
2. Click the **Paper** tab.
3. Select the paper size you want from the **Fit to Page**.
4. Select the **Size**, **Source**, and **Type** in **Paper Options**.
5. Click **OK** or **Print** until you exit the **Print** window.

Using watermarks

The watermark option allows you to print text over an existing document. For example, you use it when you want to have large gray letters reading "DRAFT" or "CONFIDENTIAL" printed diagonally across the first page or all pages of a document.



There are several predefined watermarks that come with the machine. They can be modified, or you can add new ones to the list.

Using an existing watermark

1. To change the print settings from your software application, access **Printing Preferences**. (See "Opening printing preferences" on page 42.)
2. Click the **Advanced** tab, and select the desired watermark from the **Watermark** drop-down list. You will see the selected watermark in the preview image.
3. Click **OK** or **Print** until you exit the print window.

Creating a watermark

1. To change the print settings from your software application, access **Printing Preferences**. (See "Opening printing preferences" on page 42.)
2. From the **Advanced** tab, select **Edit** from the **Watermark** drop-down list. The **Edit Watermarks** window appears.
3. Enter a text message in the **Watermark Message** box. You can enter up to 256 characters. The message displays in the preview window.
When the **First Page Only** box is checked, the watermark prints on the first page only.
4. Select watermark options.
You can select the font name, style, size, and shade from the **Font Attributes** section, as well as set the angle of the watermark from the **Message Angle** section.
5. Click **Add** to add a new watermark to the **Current Watermarks** list.
6. When you have finished editing, click **OK** or **Print** until you exit the **Print** window.

To stop printing the watermark, select **None** from the **Watermark** drop-down list.

Editing a watermark

1. To change the print settings from your software application, access **Printing Preferences**. (See "Opening printing preferences" on page 42.)
2. Click the **Advanced** tab, select **Edit** from the **Watermark** drop-down list. The **Edit Watermarks** window appears.
3. Select the watermark you want to edit from the **Current Watermarks** list and change the watermark message and options.
4. Click **Update** to save the changes.
5. Click **OK** or **Print** until you exit the **Print** window.

Deleting a watermark

1. To change the print settings from your software application, access **Printing Preferences**. (See "Opening printing preferences" on page 42.)
2. Click the **Advanced** tab, select **Edit** from the **Watermark** drop-down list. The **Edit Watermarks** window appears.
3. Select the watermark you want to delete from the **Current Watermarks** list and click **Delete**.
4. Click **OK** or **Print** until you exit the **Print** window.

Using overlay

An overlay is text and/or images stored in the computer hard disk drive (HDD) as a special file format that can be printed on any document. Overlays are often used to take the place of letterhead paper. Rather than using preprinted letterhead, you can create an overlay containing exactly the same information that is currently on your letterhead. To print a letter

with your company's letterhead, you do not need to load preprinted letterhead paper in the machine just print the letterhead overlay on your document.

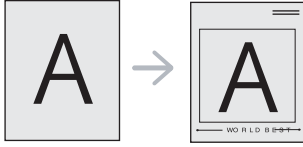

Creating a new page overlay

To use a page overlay, you must create a new page overlay containing your logo or image.

1. Create or open a document containing text or an image for use in a new page overlay. Position the items exactly as you wish them to appear when printed as an overlay.
2. To save the document as an overlay, access **Printing Preferences**. (See "Opening printing preferences" on page 42.)
3. Click the **Advanced** tab, and select **Edit** from the **Text** drop-down list. **Edit Overlay** window appears.
4. In the **Edit Overlay** window, click **Create**.
5. In the **Save As** window, type a name of up to eight characters in the **File name** box. Select the destination path, if necessary. (The default is C:\Formover.)
6. Click **Save**. The name appears on the **Overlay List**.
7. Click **OK** or **Print** until you exit the **Print** window.
8. The file is not printed. Instead, it is stored on your computer hard disk drive.

 The overlay document size must be the same as the document you print with the overlay. Do not create an overlay with a watermark.

Using a page overlay

After an overlay has been created, it is ready to be printed with your document. To print an overlay with a document:

1. Create or open the document you want to print.
2. To change the print settings from your software application, access **Printing Preferences**. (See "Opening printing preferences" on page 42.)
3. Click the **Advanced** tab.
4. Select the desired overlay from the **Text** drop-down list.
5. If the overlay file you want does not appear in the **Text** drop-down list, select **Edit** from the list and click **Load**. Select the overlay file you want to use.

If you have stored the overlay file you want to use in an external source, you can also load the file when you access the **Open** window.

After you select the file, click **Open**. The file appears in the **Overlay List** box and is available for printing. Select the overlay from the **Overlay List** box.

6. If necessary, check **Confirm Page Overlay When Printing** box. If this box is checked, a message window appears each time you submit a document for printing, asking you to confirm your wish to print an overlay on your document.
If this box is not checked and an overlay has been selected, the overlay automatically prints with your document.
7. Click **OK** or **Print** until you exit the **Print** window.
The selected overlay prints on your document.

 The resolution of the overlay document must be the same as that of the document you will print with the overlay.

Deleting a page overlay

You can delete page overlays that you no longer use.

1. In the **Printing Preferences** window, click the **Advanced** tab.
2. Select **Edit** in the **Overlay** drop down list.
3. Select the overlay you want to delete from the **Overlay List** box.
4. Click **Delete**.
5. When a confirming message window appears, click **Yes**.
6. Click **OK** or **Print** until you exit the **Print** window.

Advanced Options

Use the following **Graphics** options to adjust the print quality for your specific printing needs.

 If the option is grayed out or not shown, that option is not applicable with the printer language you are using.

1. To change the print settings from your software application, access **Printing Preferences**. (See "Opening printing preferences" on page 42.)
2. Click the **Graphics** tab.
 -  Refer to the online help for each option's information provided from the **Printing Preferences**.
 - **Font/Text**: Select **Darken Text** to print texts darker than on a normal document. Use **All Text Black** to prints solid black, regardless of the color it appears on the screen.
 - **Graphic Controller**: It allows user to emphasize edges of texts and fine lines for improving readability and align each color channel registration in color printing mode.
 - **Toner Save Mode** : Selecting this option extends the life of your toner cartridge and reduces your cost per page without a significant reduction in print quality.
 - **Printer Setting**: If you select this option, this feature is determined by the setting you've made on the control panel of the printer.
 - **On**: Select this option to allow the printer to use less toner on each page.
 - **Off**: If you do not need to save toner when printing a document, select this option.
3. Click **OK** or **Print** until you exit the **Print** window.

CHANGING THE DEFAULT PRINT SETTINGS

1. Click the Windows **Start** menu.
 - For Windows 2000, select **Settings** and then **Printers**.
 - For Windows XP/2003, select **Printers and Faxes**.
 - For Windows 2008/Vista, select **Control Panel > Hardware and Sound > Printers**.
2. Select your machine.
3. Right-click on the printer driver icon and select **Printing Preferences**.
4. Change the settings on each tab.
5. Click **OK**.

 Most Windows applications will override settings you specify in the printer driver. Change all print settings available in the software application first, and change any remaining settings using the printer driver.

SETTING YOUR MACHINE AS A DEFAULT MACHINE

1. Click the Windows **Start** menu.
 - For Windows 2000, select **Settings > Printers**.
 - For Windows XP/2003, select **Printers and Faxes**.
 - For Windows 2008/Vista, select **Control Panel > Hardware and Sound > Printers**.
2. Select your machine.
3. Right-click your machine and select **Set as Default Printer**.

PRINTING TO A FILE (PRN)

You will sometimes need to save the print data as a file.

To create a file:

1. Check the **Print to file** box at the **Print** window.

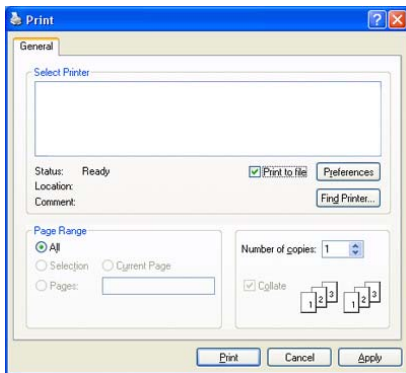

2. Click **Print**.
3. Type in the destination path and the file name, and then click **OK**.
For example c:\Temp\file name.
 If you type in only the file name, the file is automatically saved in My Documents.

MACINTOSH PRINTING

This chapter explains how to print using Macintosh. You need to set the print environment before printing.

- USB connected (See "Macintosh" on page 26.)
- Network connected (See "Macintosh" on page 32.)

Printing a document

When you print with a Macintosh, you need to check the printer driver setting in each application you use. Follow the steps below to print from a Macintosh:

1. Open an application and select the file you want to print.
2. Open the **File** menu and click **Page Setup (Document Setup** in some applications).

3. Choose your paper size, orientation, scaling, other options, and make sure that your machine is selected. Click **OK**.

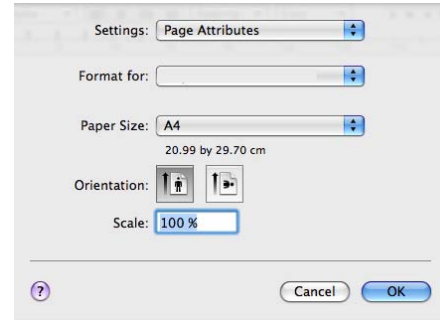

4. Open the **File** menu and click **Print**.
5. Choose the number of copies you want and indicate which pages you want to print.
6. Click **Print**.

Changing printer settings

You can use advanced printing features when using your machine.

Open an application and select **Print** from the **File** menu. The machine name, which appears in the printer properties window may differ depending on the machine in use. Except for the name, the composition of the printer properties window is similar to the following.

-  The setting options may differ depending on printers and Macintosh OS version.

Layout

The **Layout** tab provides options to adjust how the document appears on the printed page. You can print multiple pages on one sheet of paper. Select **Layout** from the drop-down list under **Orientation** to access the following features.

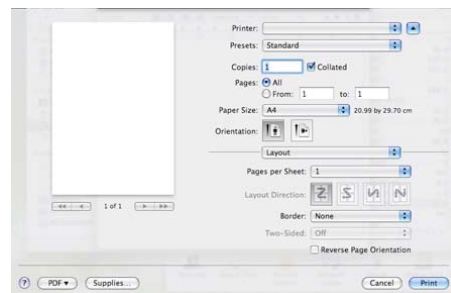

- **Pages per Sheet:** This option determines how many pages to be printed on one page. (See "Printing multiple pages on one sheet of paper" on page 47.)
- **Layout Direction:** This option allows you to select the printing direction on a page similar to the examples on UI.
- **Border:** This option allows you to print a border around each page on the sheet.
- **Reverse Page Orientation:** This option allows you to rotate paper 180 degrees.

Graphics

The **Graphics** tab provides options for selecting **Resolution**. Select **Graphics** from the drop-down list under **Orientation** to access the graphic features.

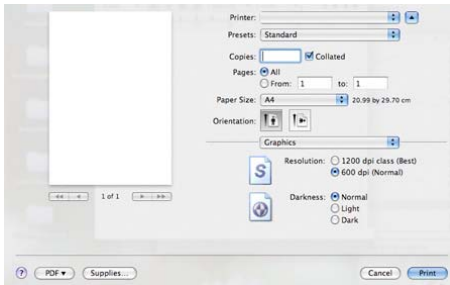

- **Resolution (Quality):** This option allows you to select the printing resolution. The higher the setting, the sharper the clarity of printed characters and graphics. The higher setting also may increase the time it takes to print a document.
- **Darkness:** This option allows you to enhance printouts. The available options are **Normal**, **Light**, and **Dark**.

Paper

Set **Paper Type** to correspond to the paper loaded in the tray from which you want to print. This will let you get the best quality printout. If you load a different type of print material, select the corresponding paper type.

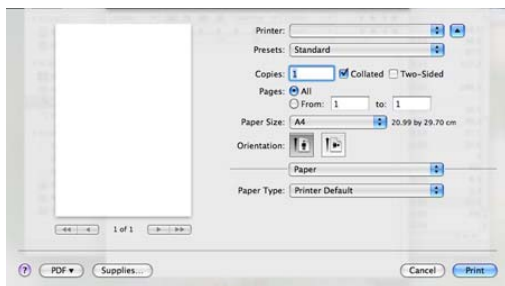

Printer Settings

Printer Settings tab provides **Toner Save Mode**, **Reprint When Jammed**, and **Power Save** options. Select **Printer Settings** from the drop-down list under **Orientation** to access the following features:

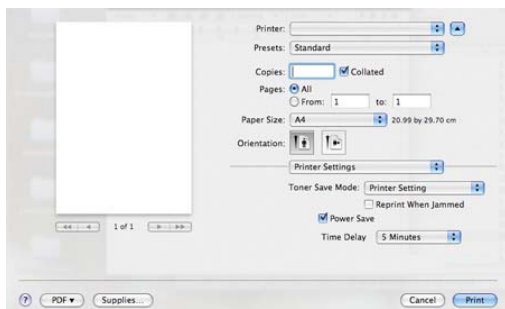

- **Toner Save Mode :** Selecting this option extends the life of your

toner cartridge and reduces your cost per page without a significant reduction in print quality.

- **Printer Setting:** If you select this option, this feature is determined by the setting you've made on the control panel of the printer.
- **On:** Select this option to allow the printer to use less toner on each page.
- **Off:** If you do not need to save toner when printing a document, select this option.
- **Reprint When Jammed:** When this option is checked, the machine retains the image of a printed page until the machine signals that the page has successfully exited the machine. If a paper jam occurs, the printer will reprint the last page sent from the computer after you have cleared the jam.
- **Power Save:** When this option is checked, the machine turns to the power save mode after the selected time.

Printing multiple pages on one sheet of paper

You can print more than one page on a single sheet of paper. This feature provides a cost-effective way to print draft pages.

1. Open an application, and select **Print** from the **File** menu.
2. Select **Layout** from the drop-down list under **Orientation**. In the **Pages per Sheet** drop-down list, select the number of pages you want to print on one sheet of paper.

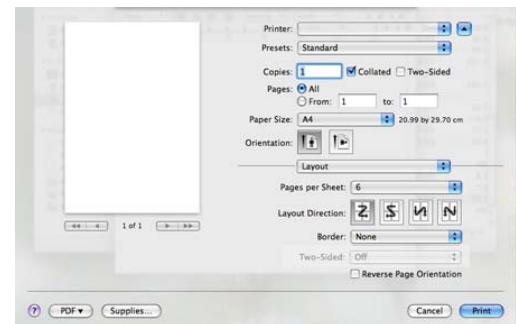

3. Select the other options you want to use.
4. Click **Print**, then the machine prints the selected the number of pages you want to print on one sheet of paper.

LINUX PRINTING

Printing from applications

There are a lot of Linux applications that allow you to print using Common UNIX Printing System (CUPS). You can print on your machine from any such application.

1. Open an application, and select **Print** from the **File** menu.
2. Select **Print** directly using lpr.

- In the LPR GUI window, select the model name of your machine from the printer list and click **Properties**.

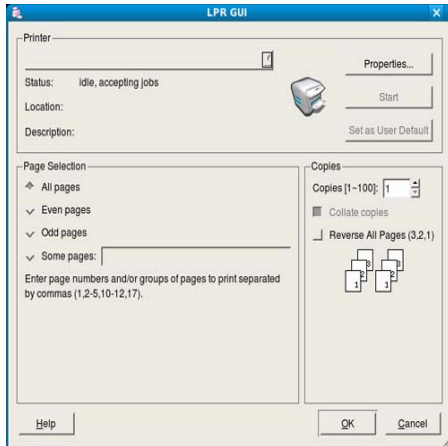

- Change the print job properties using the following four tabs displayed at the top of the window.

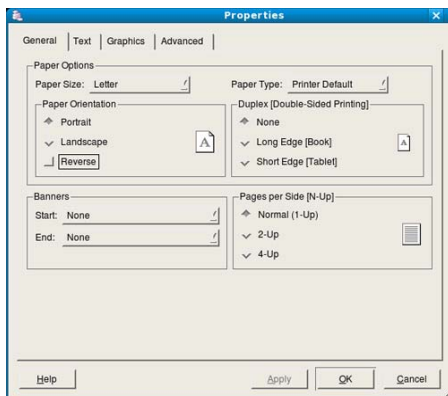

- General:** This option allows you to change the paper size, the paper type, and the orientation of the documents. It enables the duplex feature, adds start and end banners, and changes the number of pages per sheet.
- Text:** This option allows you to specify the page margins and set the text options, such as spacing or columns.
- Graphics:** This option allows you to set image options that are used when printing images/files, such as color options, image size, or image position.
- Advanced:** This option allows you to set the print resolution, paper source, and destination.

 If an option is grayed out, it means that the grayed out option is not supported.

- Click **Apply** to apply the changes and close the **Properties** window.
- Click **OK** in the **LPR GUI** window to start printing.
- The Printing window appears, allowing you to monitor the status of your print job.
To abort the current job, click **Cancel**.

Printing files

You can print many different types of files on your machine using the standard CUPS way, directly from the command line interface. The CUPS lpr utility allows you to do that. But the drivers package replaces the standard lpr tool by a much more user-friendly LPR GUI program.

To print any document file:

- Type `lpr <file_name>` from the Linux shell command line and press Enter. The **LPR GUI** window appears.
When you type only `lpr` and press **Enter**, the **Select file(s) to print** window appears first. Just select any files you want to print and click **Open**.
- In the **LPR GUI** window, select your machine from the list, and change the print job properties.
- Click **OK** to start printing.

Configuring printer properties

Using the **Printer Properties** window provided by the **Printers configuration**, you can change the various properties for your machine as a printer.

- Open the **Unified Driver Configurator**.
If necessary, switch to **Printers configuration**.
- Select your machine on the available printers list and click **Properties**.
- The **Printer Properties** window opens.

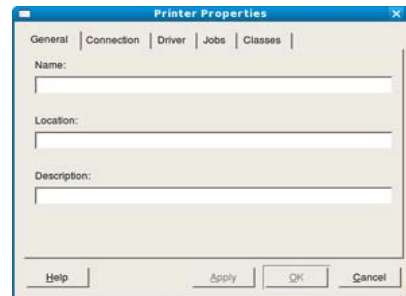

The following five tabs display at the top of the window:

- General:** This option allows you to change the printer location and name. The name entered in this tab displays on the printer list in **Printers configuration**.
- Connection:** This option allows you to view or select another port. If you change the machine port from USB to parallel or vice versa while in use, you must re-configure the machine port in this tab.
- Driver:** Allows you to view or select another printer driver. By clicking **Options**, you can set the default device options.
- Jobs:** This option shows the list of print jobs. Click **Cancel job** to cancel the selected job and select the **Show completed jobs** check box to see previous jobs on the job list.
- Classes:** This option shows the class that your machine is in. Click **Add to Class** to add your machine to a specific class or click **Remove from Class** to remove the machine from the selected class.

- Click **OK** to apply the changes and close the **Printer Properties** window.

management tools

This chapter introduces management tools provided to help you make full use of your machine.

This chapter includes:

- Introducing useful management tools
- Using SyncThru™ Web Service (ML-2580 Series only)
- Using the Smart Panel program

INTRODUCING USEFUL MANAGEMENT TOOLS

The programs below help you to use your machine conveniently.

- "Using SyncThru™ Web Service (ML-2580 Series only)" on page 49.
- "Using the Smart Panel program" on page 50.
- "Using SetIP program (ML-2580 Series only)" on page 50.
- "Using the Unified Linux Driver Configurator" on page 51.

USING SYNCTHRU™ WEB SERVICE (ML-2580 SERIES ONLY)

 Your SyncThru™ Web Service window that appears in this user's guide may differ depending on the machine in use.

If you have connected your machine to a network and set up TCP/IP network parameters correctly, you can manage the machine via SyncThru™ Web Service, an embedded web server. Use SyncThru™ Web Service to:

- View the machine's device information and check its current status.
- Change TCP/IP parameters and set up other network parameters.
- Change printer preference.
- Set the email notifications advising of the machine's status.
- Get support for using the machine.

To access SyncThru™ Web Service:

1. Access a web browser, such as Internet Explorer, from Windows. Enter the machine IP address (<http://xxx.xxx.xxx.xxx>) in the address field and press the Enter key or click **Go**.
2. Your machine's embedded website opens.

SyncThru™ Web Service overview



- **Information tab:** This tab gives you general information about your machine. You can check things, such as the machine's IP address, remaining amount of toner, ethernet information, firmware version, and

- Using SetIP program (ML-2580 Series only)
- Using the Unified Linux Driver Configurator

so on. You can also print reports such as an error report and so on.

- **Machine Settings tab:** This tab allows you to set options provided by your machine.
- **Network Settings tab:** This tab allows you to view and change the network environment. You can set things, such as TCP/IP, enabling Ether Talk and so on.
- **Maintenance tab:** This tab allows you to maintain your machine by upgrading firmware and setting security information.
- **Support tab:** This tab allows you to set contact information for sending email. You can also connect to SEC website or download drivers by selecting Link.

E-mail notification setup

You can receive emails about your machine's status by setting this option.

1. Start a web browser, such as Internet Explorer, from Windows. Enter the machine IP address (<http://xxx.xxx.xxx.xxx>) in the address field and press the Enter key or click **Go**.
2. Your machine's embedded website opens.
3. From the **Machine Settings**, select **E-mail Notification Setup**.
4. Set required settings.

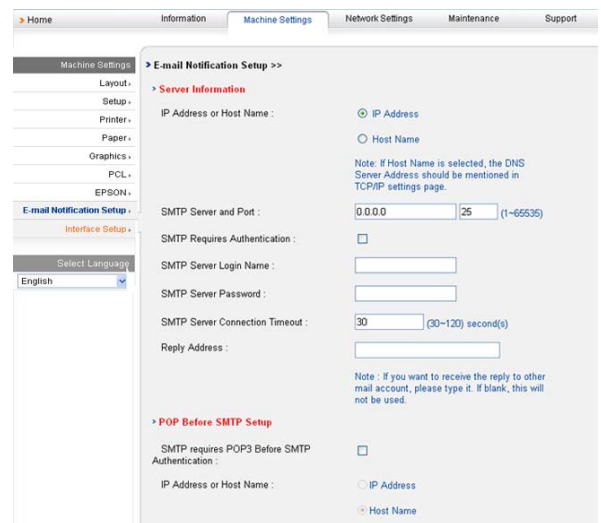

5. Click **Apply**.

USING THE SMART PANEL PROGRAM

Smart Panel is a program that monitors and informs you of the machine status, and allows you to customize the machine's settings. Smart Panel is installed automatically when you install the machine software.



-  To use this program, you need the following system requirements:
- Windows. Check for windows operating system(s) compatible with your machine. (See "System requirements" on page 24.)
 - Mac OS X 10.3 or higher
 - Linux. Check for Linux systems that are compatible with your machine. (See "System requirements" on page 24.)
 - Internet Explorer version 5.0 or higher for flash animation in HTML Help.

If you need to know the exact model name of your machine, you can check the supplied software CD.

Understanding Smart Panel

If an error occurs while printing, you can check the error from the Smart Panel.

You can also launch Smart Panel manually. Double-click the Smart Panel icon on the Windows task bar (in Windows), or Notification Area (in Linux). You can also click it on the status bar (in Mac OS X).

Windows		Double-click this icon in Windows.
Macintosh		Click this icon in Mac OS X.
Linux		Click this icon in Linux.



Or, if you are a Windows user, you can launch it from the **Start** menu, select **Programs** or **All Programs** > **Samsung Printers** > **your printer driver name** > **Smart Panel**.

-  • If you have already installed more than one Samsung machine, first select the correct machine model you want in order to access the corresponding Smart Panel.
- Right-click (in Windows or Linux) or click (in Mac OS X) the Smart Panel icon and select your machine.
- The Smart Panel window and its contents shown in this user's guide may differ depending on the machine or operating system in use.

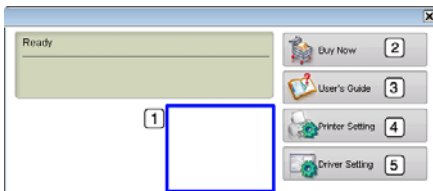
The Smart Panel program displays the current status of the machine, the level of toner remaining in the toner cartridge(s), and various other types of information. You can also change settings.



1	Toner Level	View the level of toner remaining in the toner cartridge(s). The machine and the number of toner cartridge(s) shown in the above window may differ depending on the machine in use. Some machines do not have this feature.
----------	--------------------	---

2	Buy Now	Order replacement toner cartridge(s) online.
3	User's Guide	View User's Guide.  This button changes to Troubleshooting Guide when error occurs. You can directly open troubleshooting section in the user's guide.
4	Printer Setting (ML-2580 Series only)	Configure various machine settings in the Printer Settings Utility window. Some machines do not have this feature.  If you connect your machine to a network, the SyncThru™ Web Service window appears instead of the Printer Settings Utility window.
5	Driver Setting	Set all of the machine options you need in the Printer Preferences window. This feature is available only for Windows. (See "Opening printing preferences" on page 42.)

Opening the Troubleshooting Guide

Find solutions for problems by using the **Troubleshooting Guide**.

Right-click (in Windows or Linux) or click (in Mac OS X) the Smart Panel icon and select **Troubleshooting Guide**.

Changing the Smart Panel Program Settings

Right-click (in Windows or Linux) or click (in Mac OS X) the Smart Panel icon and select **Options**. Select the settings you want from the **Options** window.

USING SETIP PROGRAM (ML-2580 SERIES ONLY)

This program is for the network IP setting using the MAC address which is the hardware serial number of the network printer card or interface.

It is especially for the network administrator to set several network IPs at the same time.

-  You can only use the SetIP program when your machine is connected to a network.

Windows

The following procedure is based on the Windows XP operating system.

Installing the program

1. Insert the software CD provided with your machine. When the software CD runs automatically, close the window.
2. From the **Start** menu select **My Computer** and open the X drive. (X represents your CD-ROM drive.)
3. Double click **Application** > **SetIP**.
4. Double-click **Setup.exe** to install this program.
5. Click **OK**.
If necessary, select a language from the drop-down list.
6. Follow the instructions in the window to complete the installation.

Printing out the machine's MAC address

In ready mode, press and hold the  (cancel button) for about 5 seconds. You can find your machine's MAC address and IP address.

Setting network values

1. Print the machine's network configuration report to find your machine's MAC address.
2. From the Windows **Start** menu, select **All Programs > Samsung Printers > SetIP > SetIP**.
3. Click to open the TCP/IP configuration window.
4. Enter the network card's MAC address, IP address, subnet mask, default gateway, and then click **Apply**.
 When you enter the MAC address, enter it without a colon(:).
5. The machine prints the network information. Confirm all the settings are correct.
6. Close the SetIP program.

Macintosh



SetIP program should be automatically installed during the printer driver installation.

Printing out the machine's MAC address

In ready mode, press and hold the ⌘ (cancel button) for about 5 seconds. You can find your machine's MAC address and IP address.

Setting network values

If you want to change your network printer IP setting, follow the below instruction.

-  If you select **Typical installation for a network printer** during the printer driver installation, the SetIP program automatically runs after the installation. Go to step 4.
1. Print the machine's network configuration report to find your machine's MAC address.
2. Open the **Library** folder > **Printers > Samsung > your printer model name > SetIP**.
3. Double click the **SetIPApplet.html** file.
4. The certificate window appears, click **Trust**.
5. Click to open the TCP/IP configuration window.
6. Enter the network card's MAC address, IP address, subnet mask, default gateway, and then click **Apply**.
 When you enter the MAC address, enter it without a colon(:).
7. The machine prints the network information. Confirm all the settings are correct.
8. Close the SetIP program.

Linux

SetIP program should be automatically installed during the printer driver installation.

Printing out the machine's MAC address

In ready mode, press and hold the ⌘ (cancel button) for about 5 seconds. You can find your machine's MAC address and IP address.

Setting network values

1. Print the machine's network configuration report to find your machine's MAC address.
2. Open the **/opt/Samsung/mfp/share/utills/**.
3. Double click the **SetIPApplet.html** file.
4. Click to open the TCP/IP configuration window.

5. Enter the network card's MAC address, IP address, subnet mask, default gateway, and then click **Apply**.
 When you enter the MAC address, enter it without a colon(:).
6. The machine prints the network information. Confirm all the settings are correct.
7. Close the SetIP program.

USING THE UNIFIED LINUX DRIVER CONFIGURATOR

The supplied software CD provides you with the Unified Linux Driver package for using your machine with a Linux computer. Unified Linux Driver Configurator is a tool primarily intended for configuring machine devices.

After the driver is installed on your Linux system, the Unified Linux Driver Configurator icon will automatically be created on your desktop.

Opening the Unified Driver Configurator

1. Double-click the **Unified Driver Configurator** on the desktop. You can also click the **Startup** Menu icon and select **Samsung Unified Driver > Unified Driver Configurator**.
2. Click each button on the left to switch to the corresponding configuration window.

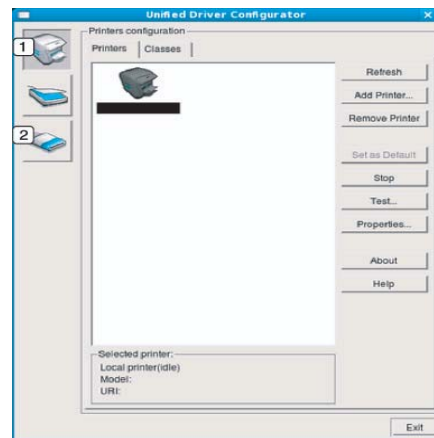

- 1 **Printers Configuration**
- 2 **Ports Configuration**

-  To use the on screen help, click **Help**.

3. After changing the configurations, click **Exit** to close the Unified Driver Configurator.

Printers configuration

Printers configuration has the two tabs: **Printers** and **Classes**.

Printers tab

View the current system's printer configuration by clicking on the machine icon button on the left side of the Unified Driver Configurator window.

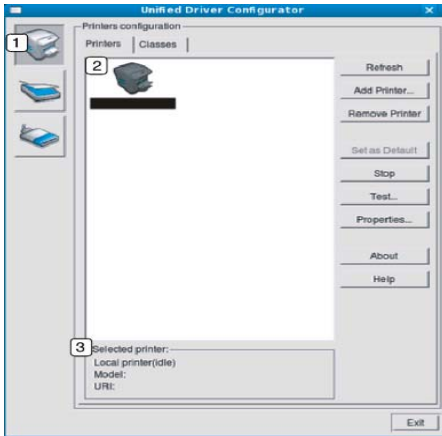

- | | |
|---|---|
| 1 | Switches to Printers configuration . |
| 2 | Shows all of the installed machine. |
| 3 | Shows the status, model name and URI of your machine. |

The printer control buttons are, as follows:

- **Refresh**: Renewes the available machines list.
- **Add Printer**: Allows you to add a new machines.
- **Remove Printer**: Removes the selected machine.
- **Set as Default**: Sets the current selected machine as a default machine.
- **Stop/Start**: Stops/starts the machine.
- **Test**: Allows you to print a test page to ensure the machine is working properly.
- **Properties**: Allows you to view and change the printer properties.

Classes tab

The Classes tab shows a list of available machine classes.

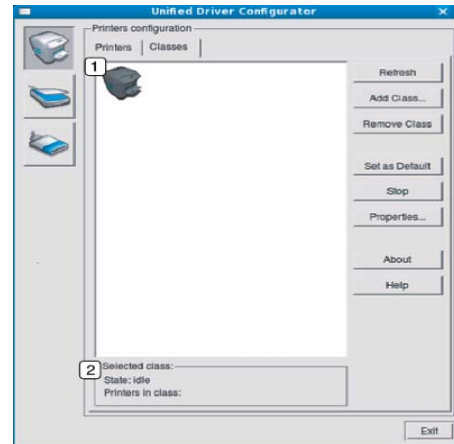

- | | |
|---|--|
| 1 | Shows all of the machine classes. |
| 2 | Shows the status of the class and the number of machines in the class. <ul style="list-style-type: none"> • Refresh: Renewes the classes list. • Add Class: Allows you to add a new machine class. • Remove Class: Removes the selected machine class. |

Ports configuration

In this window, you can view the list of available ports, check the status of each port and release a port that is stalled in a busy state when its owner has terminated the job for any reason.

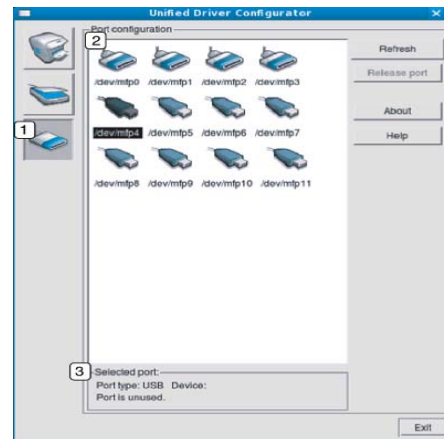

- | | |
|---|---|
| 1 | Switches to Ports configuration . |
| 2 | Shows all of the available ports. |
| 3 | Shows the port type, device connected to the port, and status |

- **Refresh:** Renews the available ports list.
- **Release port:** Releases the selected port.

maintenance

This chapter provides information for maintaining your machine and the toner cartridge.

This chapter includes:

- Printing a machine report
- Monitoring the supplies life
- Using toner low alert (ML-2580 Series only)

PRINTING A MACHINE REPORT

You can print a configuration page to view current printer settings, or to help troubleshoot printer problems.

In ready mode, press and hold the Ⓞ (cancel button) for about 5 seconds. A configuration page prints out.

MONITORING THE SUPPLIES LIFE

To view the supply life indicators:

In ready mode, press and hold the Ⓞ (cancel button) for about 10 seconds.

USING TONER LOW ALERT (ML-2580 SERIES ONLY)

If the amount of toner in the cartridge is low, the ⚠ LED blinks red. You can set the option for this ⚠ LED to blink or not.

1. Ensure that you have installed the printer driver with the provided Printer Software CD.
2. Double-click the **Smart Panel** icon on the Windows task bar (or Notification Area in Linux). You can also click **Smart Panel** on the status bar in Mac OS X.
3. Click **Printer Setting**.
4. Click **Setting > Toner Low Alert**. Select the appropriate setting and then click **Apply**.

CLEANING A MACHINE

If printing quality problems occur or if you use your machine in a dusty environment, you need to clean your machine regularly to keep the best printing condition and use your machine longer.



- Cleaning the cabinet of the machine with cleaning materials containing large amounts of alcohol, solvent, or other strong substances can discolor or distort the cabinet.
- If your machine or the surrounding area is contaminated with toner, we recommend you use cloth or tissue dampened with water to clean it. If you use a vacuum cleaner, toner blows in the air and might be harmful to you.

Cleaning the outside

Clean the machine cabinet with a soft, lint-free cloth. Dampen the cloth slightly with water, but be careful not to let any water drip onto or into the machine.

- Cleaning a machine
- Storing the Toner cartridge
- Tips for moving & storing your machine

Printing a cleaning sheet

If you are experiencing blurred or smeared printouts, you can clear the problem by printing a cleaning sheet, provided by your machine.

To print the cleaning sheet:

In ready mode, press and hold the Ⓞ (cancel button) for about 8 seconds.

- **OPC cleaning sheet:** Cleans the OPC drum of the toner cartridge. This process will produce a page with toner debris, which should be discarded.

Your machine automatically picks up a sheet of paper from the tray and prints out a cleaning sheet with dust or toner particles on it.

Cleaning the inside

During the printing process, paper, toner, and dust particles can accumulate inside the machine. This buildup can cause print quality problems, such as toner specks or smearing. Cleaning the inside of the machine clears and reduces these problems.

1. Turn the machine off and unplug the power cord. Wait for the machine to cool down.
2. Open the front cover and pull the toner cartridge out. Set it on a clean flat surface

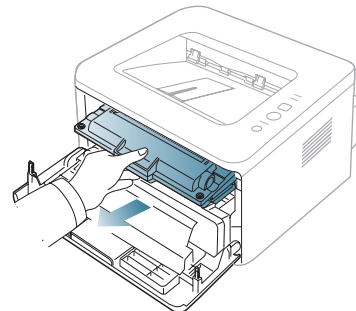

- To prevent damage to the toner cartridge, do not expose it to light for more than a few minutes. Cover it with a piece of paper, if necessary.
- Do not touch the green surface underside of the toner cartridge. Use the handle on the cartridge to avoid touching this area.

- With a dry, lint-free cloth, wipe away any dust and spilled toner from the toner cartridge area.

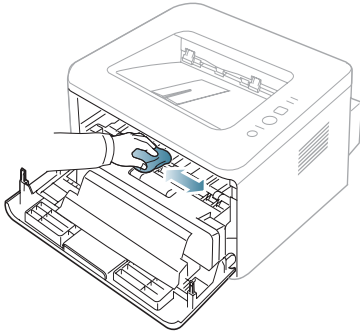

⚠ While cleaning the inside of the machine, be careful not to damage the transfer roller or any other inside parts. Do not use solvents such as benzene or thinner to clean. Printing quality problems can occur and cause damage to the machine.

- Locate the long strip of glass (LSU) inside the top of the cartridge compartment and gently swab the glass to see if dirt turns the white cotton black.

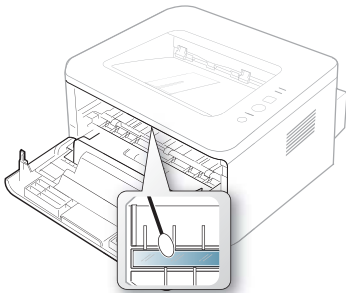

- Reinsert the toner cartridge and close the front cover.
- Plug in the power cord and turn the machine on.

STORING THE TONER CARTRIDGE

Toner cartridges contain components that are sensitive to light, temperature, and humidity. Samsung suggests users follow the recommendations to ensure the optimum performance, highest quality, and longest life from your new Samsung toner cartridge.

Store this cartridge in the same environment as the printer it will be used in; this should be in controlled office temperature and humidity conditions. The toner cartridge should remain in its original, unopened package until installation – If original packaging is not available, cover the top opening of the cartridge with paper and store in a dark cabinet.

Opening the cartridge package prior to use dramatically shortens its useful shelf and operating life. Do not store on the floor. If the toner cartridge is removed from the printer, always store the cartridge:

- Inside the protective bag from the original package.
- Correct side up in a horizontal position (not standing on end).
- Do not store consumables in;
 - Temperature greater than 40°C (104°F).

- Humidity range less than 20% and not greater than 80%.
- An environment with extreme changes in humidity or temperature.
- Direct sunlight or room light.
- Dusty places.
- A car for a long period of time.
- An environment where corrosive gases are present.
- An environment with salty air.

Handling instructions

- Do not touch the surface of the photosensitive drum in the cartridge.
- Do not expose the cartridge to unnecessary vibrations or shock.
- Never manually rotate the drum, especially in the reverse direction; this can cause internal damage and toner spillage.

Use of non-Samsung and refilled toner cartridge

Samsung Electronics does not recommend or approve the use of non-Samsung brand toner cartridges in your printer including generic, store brand, refilled, or remanufactured toner cartridges.

⚠ Samsung's printer warranty does not cover damage to the machine caused by the use of a refilled, remanufactured, or non-Samsung brand toner cartridge.

Estimated cartridge life

Estimated cartridge life (the life of the toner cartridge yield) depends on the amount of toner that print jobs require. The actual print-out number may vary depending on the print density of the pages you print on, operating environment, printing interval, media type, and/or media size. For example, if you print a lot of graphics, the consumption of the toner is high and you may need to change the cartridge more often.

TIPS FOR MOVING & STORING YOUR MACHINE

- When moving the machine, do not tilt or turn it upside down. Otherwise, the inside of the machine may be contaminated by toner, which can cause damage to the machine or bad print quality.
- When moving the machine, make sure at least two people are holding the machine securely.

troubleshooting

This chapter gives helpful information for what to do if you encounter an error.

This chapter includes:

- Redistributing toner
- Tips for avoiding paper jams

REDISTRIBUTING TONER

When the toner cartridge is near the end of its life:

- White streaks or light printing occurs.
- The  LED blinks red.

If this happens, you can temporarily improve print quality by redistributing the remaining toner in the cartridge. In some cases, white streaks or light printing will still occur even after you have redistributed the toner.

1. Open the front cover.
2. Pull the toner cartridge out.

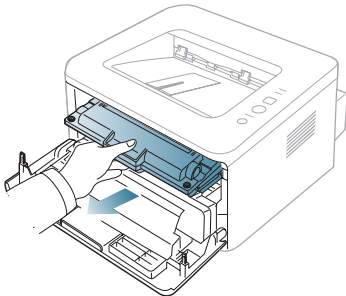

3. Thoroughly roll the cartridge five or six times to distribute the toner evenly inside the cartridge.

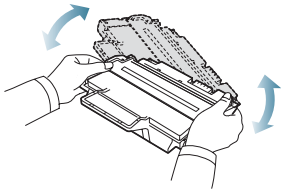

 If toner gets on your clothing, wipe it off with a dry cloth and wash clothing in cold water. Hot water sets toner into fabric.

 Do not touch the green underside of the toner cartridge. Use the handle on the cartridge to avoid touching this area.

4. Hold the toner cartridge by the handle and slowly insert the cartridge into the opening in the machine.

Tabs on the sides of the cartridge and corresponding grooves within the machine will guide the cartridge into the correct position until it locks into

- Clearing paper jams
- Solving other problems

place completely.

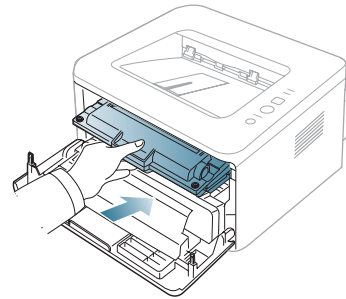

5. Close the front cover. Ensure that the cover is securely closed.

TIPS FOR AVOIDING PAPER CURLS

1. Open the rear cover.
2. Pull down the pressure lever on each side.

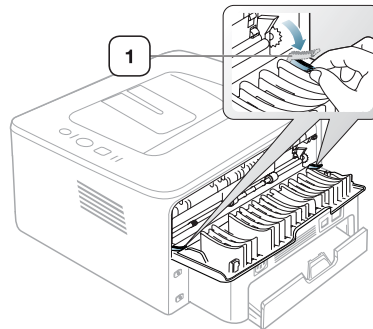

1 Pressure lever

-  Keep the rear cover opened during printing. Only use when the printout has more than 20 mm curl.



TIPS FOR AVOIDING PAPER JAMS

By selecting the correct media types, most paper jams can be avoided. When a paper jam occurs, refer to the next guidelines.

- Ensure that the adjustable guides are positioned correctly. (See "Loading paper in the tray" on page 37.)
- Do not overload the tray. Ensure that the paper level is below the paper capacity mark on the inside of the tray.
- Do not remove paper from the tray while your machine is printing.
- Flex, fan, and straighten paper before loading.
- Do not use creased, damp, or highly curled paper.
- Do not mix paper types in a tray.
- Use only recommended print media.
- Ensure that the recommended side of the print media is facing down in the tray, or facing up in the manual tray.

CLEARING PAPER JAMS

If a paper jam occurs, the  LED on the control panel lights orange. Find and remove the jammed paper.

To resume printing after clearing paper jams, you must open and close the front cover.

-  To avoid tearing the paper, pull the jammed paper out slowly and gently. Follow the instructions in the following sections to clear the jam.

In tray

-  Click this link to open an animation about clearing a jam.

1. Open and close the front cover. The jammed paper is automatically ejected from the machine.
If the paper does not exit, go to the next step.
2. Pull out tray.

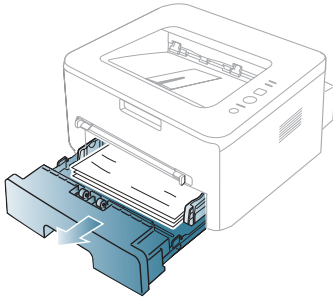

3. Remove the jammed paper by gently pulling it straight out.

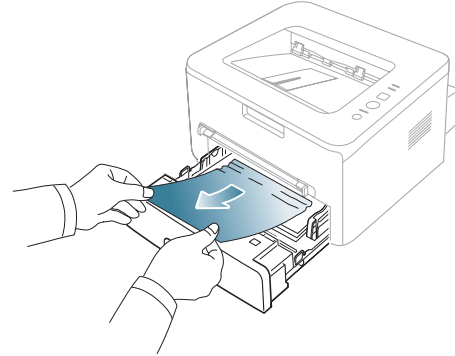

If the paper does not move when you pull, or if you do not see the paper in this area, check the fuser area around the toner cartridge. (See "Inside the machine" on page 57.)

4. Insert tray back into the machine until it snaps into place. Printing automatically resumes.

In the manual tray

-  Click this link to open an animation about clearing a jam.

1. If the paper is not feeding properly, pull the paper out of the machine.

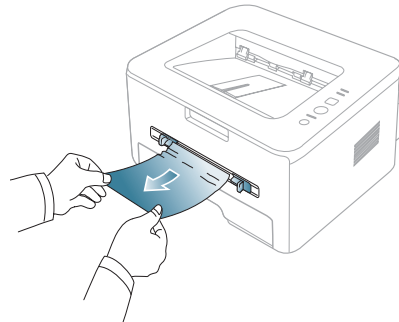

2. Open and close the front cover to resume printing.

Inside the machine

-  Click this link to open an animation about clearing a jam.

-  The fuser area is hot. Take care when removing paper from the machine.

1. Open the front cover and pull the toner cartridge out, lightly pushing it down.

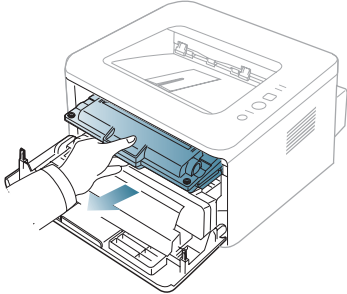

2. Remove the jammed paper by gently pulling it straight out.

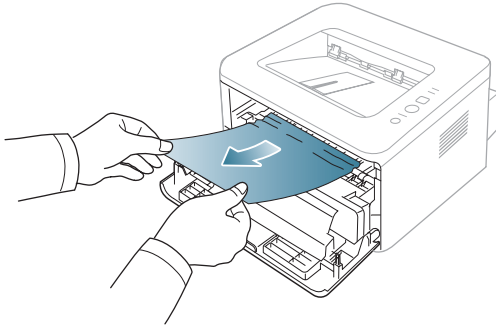

3. Replace the toner cartridge and close the front cover. Printing automatically resumes.

In exit area

 Click this link to open an animation about clearing a jam.

1. Open and close the front cover. The jammed paper is automatically ejected from the machine.
If you do not see the jammed paper, go to next step.
2. Gently pull the paper out of the output tray.

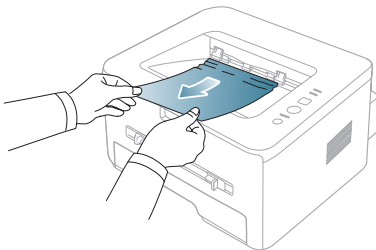

If you do not see the jammed paper or if there is any resistance when you pull, stop and go to the next step.

3. Open the rear cover.
4. Pull the pressure levers down and remove the paper.
Return the pressure levers to their original position.

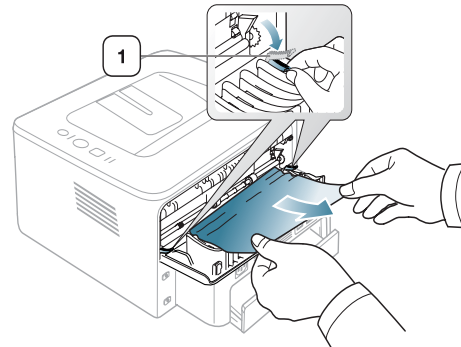

1 Pressure lever

5. Close the rear cover.
6. Open and close front cover, printing automatically resumes.

SOLVING OTHER PROBLEMS

The following chart lists some conditions that may occur and the recommended solutions. Follow the suggested solutions until the problem is corrected. If the problem persists, call for service.

Paper feeding problems

CONDITION	SUGGESTED SOLUTIONS
Paper jams during printing.	Clear the paper jam. (See "Clearing paper jams" on page 57.)
Paper sticks together.	<ul style="list-style-type: none"> Check the maximum paper capacity of the tray. (See "Print media specifications" on page 69.) Make sure that you are using the correct type of paper. (See "Print media specifications" on page 69.) Remove paper from the tray and flex or fan the paper. Humid conditions may cause some paper to stick together.
Multiple sheets of paper do not feed.	Different types of paper may be stacked in the tray. Load paper of only one type, size, and weight.
Paper does not feed into the machine.	<ul style="list-style-type: none"> Remove any obstructions from inside the machine. Paper has not been loaded correctly. Remove paper from the tray and reload it correctly. There is too much paper in the tray. Remove excess paper from the tray. The paper is too thick. Use only paper that meets the specifications required by the machine. (See "Print media specifications" on page 69.)
The paper keeps jamming.	<ul style="list-style-type: none"> There is too much paper in the tray. Remove excess paper from the tray. If you are printing on special materials, use the manual tray. An incorrect type of paper is being used. Use only paper that meets the specifications required by the machine. (See "Print media specifications" on page 69.) There may be debris inside the machine. Open the front cover and remove any debris.
Transparencies stick together in the paper exit.	Use only transparencies specifically designed for laser printers. Remove each transparency as it exits from the machine.
Envelopes skew or fail to feed correctly.	Ensure that the paper guides are against both sides of the envelopes.

Printing problems

CONDITION	POSSIBLE CAUSE	SUGGESTED SOLUTIONS
The machine does not print.	The machine is not receiving power.	Check the power cord connections.
	The machine is not selected as the default machine.	Select your machine as your default machine in your Windows.
	Check the machine for the following: <ul style="list-style-type: none"> The front cover is not closed. Close the front cover. Paper is jammed. Clear the paper jam. (See "Clearing paper jams" on page 57.) No paper is loaded. Load paper. (See "Loading paper in the tray" on page 37.) The toner cartridge is not installed. Install the toner cartridge. If a system error occurs, contact your service representative.	
	The connection cable between the computer and the machine is not connected properly.	Disconnect the machine cable and reconnect it.
	The connection cable between the computer and the machine is defective.	If possible, attach the cable to another computer that is working properly and print a job. You can also try using a different machine cable.
	The port setting is incorrect.	Check the Windows printer setting to make sure that the print job is sent to the correct port. If the computer has more than one port, make sure that the machine is attached to the correct one.
	The machine may be configured incorrectly.	Check the Printing Preferences to ensure that all of the print settings are correct. (See "Opening printing preferences" on page 42.)
	The printer driver may be incorrectly installed.	Repair the machine software. (See "Installing USB connected machine's driver" on page 24, "Installing network connected machine's driver" on page 30.)
	The machine is malfunctioning.	Check the LEDs on the control panel to see if the machine is indicating a system error. Contact a service representative.

CONDITION	POSSIBLE CAUSE	SUGGESTED SOLUTIONS
The machine does not print.	The document size is so big that the hard disk space of the computer is insufficient to access the print job.	Get more hard disk space and print the document again.
	The output tray is full.	It can hold up to 50 sheets (ML-1910 Series) and 100 sheets (ML-2525 Series, ML-2580 Series) of plain paper. Once the paper is removed from the output tray, the machine resumes printing.
The machine selects print materials from the wrong paper source.	The paper option that was selected in the Printing Preferences may be incorrect.	For many software applications, the paper source selection is found under the Paper tab within the Printing Preferences . Select the correct paper source. See the printer driver help screen. (See "Opening printing preferences" on page 42.)
A print job is extremely slow.	The job may be very complex.	Reduce the complexity of the page or try adjusting the print quality settings.
Half the page is blank.	The page orientation setting may be incorrect.	Change the page orientation in your application. See the printer driver help screen.
	The paper size and the paper size settings do not match.	Ensure that the paper size in the printer driver settings matches the paper in the tray. Or, ensure that the paper size in the printer driver settings matches the paper selection in the software application settings you use.

CONDITION	POSSIBLE CAUSE	SUGGESTED SOLUTIONS
The machine prints, but the text is wrong, garbled, or incomplete.	The machine cable is loose or defective.	Disconnect the machine cable and reconnect. Try a print job that you have already printed successfully. If possible, attach the cable and the machine to another computer that you know works and try a print job. Finally, try a new machine cable.
	The wrong printer driver was selected.	Check the application's printer selection menu to ensure that your machine is selected.
	The software application is malfunctioning.	Try printing a job from another application.
	The operating system is malfunctioning.	Exit Windows and reboot the computer. Turn the machine off and back on again.
	If you are in a DOS environment, the font setting for your machine may be set incorrectly.	See "Changing font setting (ML-2580 Series only)" on page 34.
Pages print, but they are blank.	The toner cartridge is defective or out of toner.	Redistribute the toner, if necessary. If necessary, replace the toner cartridge.
	The file may have blank pages.	Check the file to ensure that it does not contain blank pages.
	Some parts, such as the controller or the board, may be defective.	Contact a service representative.
The machine does not print PDF file correctly. Some parts of graphics, text, or illustrations are missing.	Incompatibility between the PDF file and the Acrobat products.	Printing the PDF file as an image may enable the file to print. Turn on Print As Image from the Acrobat printing options.  It will take longer to print when you print a PDF file as an image.

CONDITION	POSSIBLE CAUSE	SUGGESTED SOLUTIONS
The print quality of photos is not good. Images are not clear.	The resolution of the photo is very low.	Reduce the photo size. If you increase the photo size in the software application, the resolution will be reduced.
Before printing, the machine emits vapor near the output tray.	Using damp paper can cause vapor during printing.	This is not a problem. Just keep printing.
The machine does not print special- sized paper, such as billing paper.	Paper size and paper size setting do not match.	Set the correct paper size in the Edit... in the Paper tab in the Printing Preferences . (See "Opening printing preferences" on page 42.)

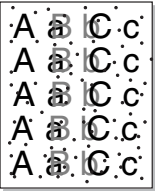
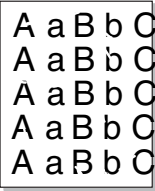

Printing quality problems

If the inside of the machine is dirty or paper has been loaded improperly, there might be a reduction in print quality. See the table below to clear the problem.

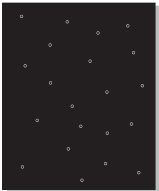
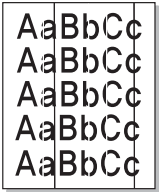
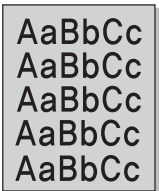
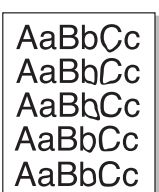
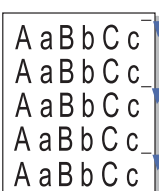
CONDITION	SUGGESTED SOLUTIONS
Light or faded print 	<ul style="list-style-type: none"> If a vertical white streak or faded area appears on the page, the toner supply is low. You may be able to temporarily extend the toner cartridge life. (See "Redistributing toner" on page 56.) If this does not improve the print quality, install a new toner cart The paper may not meet paper specifications; for example, the paper may be too moist or rough. (See "Print media specifications" on page 69.) If the entire page is light, the print resolution setting is too low or the toner save mode is on. Adjust the print resolution and turn the toner save mode off. See the help screen of the printer driver. A combination of faded or smeared defects may indicate that the toner cartridge needs cleaning. (See "Cleaning the inside" on page 54.) The surface of the LSU part inside the machine may be dirty. (See "Cleaning the inside" on page 54.)
Toner specks 	<ul style="list-style-type: none"> The paper may not meet specifications; for example, the paper may be too moist or rough. (See "Print media specifications" on page 69.) The transfer roller may be dirty. Clean the inside of your machine. Contact a service representative. The paper path may need cleaning. Contact a service representative.
Dropouts 	<p>If faded areas, generally rounded, occur randomly on the page:</p> <ul style="list-style-type: none"> A single sheet of paper may be defective. Try reprinting the job. The moisture content of the paper is uneven or the paper has moist spots on its surface. Try a different brand of paper. (See "Print media specifications" on page 69.) The paper lot is bad. The manufacturing processes can cause some areas to reject toner. Try a different kind or brand of paper. Change the printer option and try again. Go to Printing Preferences, click Paper tab, and set type to Thick. (See "Opening printing preferences" on page 42.) If these steps do not correct the problem, contact a service representative.

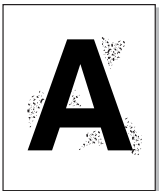
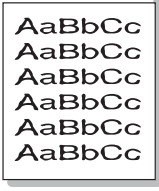
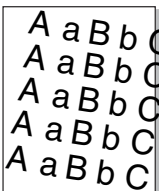
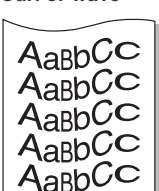
CONDITION	SUGGESTED SOLUTIONS
White Spots 	<p>If white spots appear on the page:</p> <ul style="list-style-type: none"> The paper is too rough and a lot of dirt from a paper falls to the inner devices within the machine, so the transfer roller may be dirty. Clean the inside of your machine. (See "Cleaning the inside" on page 54.) The paper path may need cleaning. (See "Cleaning the inside" on page 54.)
Vertical lines 	<p>If black vertical streaks appear on the page:</p> <ul style="list-style-type: none"> The surface (drum part) of the toner cartridge inside the machine has probably been scratched. Remove the toner cartridge and install a new one. (See "Replacing the toner cartridge" on page 65.) <p>If white vertical streaks appear on the page:</p> <ul style="list-style-type: none"> The surface of the LSU part inside the machine may be dirty. (See "Cleaning the inside" on page 54.)
Black background 	<p>If the amount of background shading becomes unacceptable:</p> <ul style="list-style-type: none"> Change to a lighter weight paper. (See "Print media specifications" on page 69.) Check the environmental conditions: very dry conditions or a high level of humidity (higher than 80% RH) can increase the amount of background shading. Remove the old toner cartridge and, install a new one. (See "Replacing the toner cartridge" on page 65.)
Toner smear 	<p>If toner smears on the page:</p> <ul style="list-style-type: none"> Clean the inside of the machine. (See "Cleaning the inside" on page 54.) Check the paper type and quality. (See "Print media specifications" on page 69.) Remove the toner cartridge and then, install a new one. (See "Replacing the toner cartridge" on page 65.)
Vertical repetitive defects 	<p>If marks repeatedly appear on the printed side of the page at even intervals:</p> <ul style="list-style-type: none"> The toner cartridge may be damaged. If you still have the same problem, remove the toner cartridge and, install a new one. (See "Replacing the toner cartridge" on page 65.) Parts of the machine may have toner on them. If the defects occur on the back of the page, the problem will likely correct itself after a few more pages. The fusing assembly may be damaged. Contact a service representative.

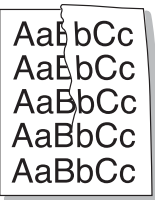
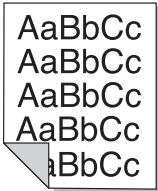
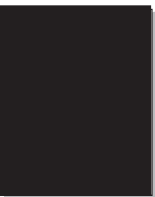
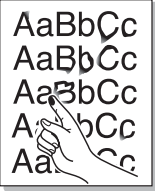
CONDITION	SUGGESTED SOLUTIONS
Background scatter 	<p>Background scatter results from bits of toner randomly distributed on the printed page.</p> <ul style="list-style-type: none"> The paper may be too damp. Try printing with a different batch of paper. Do not open packages of paper until necessary so that the paper does not absorb too much moisture. If background scatter occurs on an envelope, change the printing layout to avoid printing over areas that have overlapping seams on the reverse side. Printing on seams can cause problems. If background scatter covers the entire surface area of a printed page, adjust the print resolution through your software application or in Printing Preferences. (See "Opening printing preferences" on page 42.)
Misformed characters 	<ul style="list-style-type: none"> If characters are improperly formed and producing hollow images, the paper stock may be too slick. Try different paper. (See "Print media specifications" on page 69.)
Page skew 	<ul style="list-style-type: none"> Ensure that the paper is loaded properly. Check the paper type and quality. (See "Print media specifications" on page 69.) Ensure that the guides are not too tight or too loose against the paper stack.
Curl or wave 	<ul style="list-style-type: none"> Ensure that the paper is loaded properly. Check the paper type and quality. Both high temperature and humidity can cause paper curl. (See "Print media specifications" on page 69.) Turn the stack of paper over in the tray. Also try rotating the paper 180° in the tray.

CONDITION	SUGGESTED SOLUTIONS
Wrinkles or creases 	<ul style="list-style-type: none"> Ensure that the paper is loaded properly. Check the paper type and quality. (See "Print media specifications" on page 69.) Turn the stack of paper over in the tray. Also try rotating the paper 180° in the tray.
Back of printouts are dirty 	<p>Check for leaking toner. Clean the inside of the machine. (See "Cleaning the inside" on page 54.)</p>
Solid Color or Black pages 	<ul style="list-style-type: none"> The toner cartridge may not be installed properly. Remove the cartridge and reinsert it. The toner cartridge may be defective. Remove the toner cartridge and install a new one. (See "Replacing the toner cartridge" on page 65.) The machine may require repair. Contact a service representative.
Loose toner 	<ul style="list-style-type: none"> Clean the inside of the machine. (See "Cleaning the inside" on page 54.) Check the paper type and quality. (See "Print media specifications" on page 69.) Remove the toner cartridge and then, install a new one. (See "Replacing the toner cartridge" on page 65.) If the problem persists, the machine may require repair. Contact a service representative.
Character Voids 	<p>Character voids are white areas within parts of characters that should be solid black:</p> <ul style="list-style-type: none"> If you are using transparencies, try another type of transparency. Because of the composition of transparencies, some character voids are normal. You may be printing on the wrong surface of the paper. Remove the paper and turn it around. The paper may not meet paper specifications. (See "Print media specifications" on page 69.)

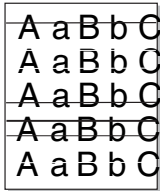
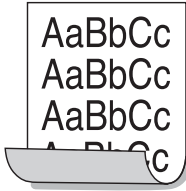
CONDITION	SUGGESTED SOLUTIONS
Horizontal stripes 	<p>If horizontally aligned black streaks or smears appear:</p> <ul style="list-style-type: none"> The toner cartridge may be installed improperly. Remove the cartridge and reinsert it. The toner cartridge may be defective. Remove the toner cartridge and install a new one. (See "Replacing the toner cartridge" on page 65.) If the problem persists, the machine may require repair. Contact a service representative.
Curl 	<p>If the printed paper is curled or paper does not feed into the machine:</p> <ul style="list-style-type: none"> Turn the stack of paper over in the tray. Also try rotating the paper 180° in the tray. Change the printer option and try again. Go to Printing Preferences, click Paper tab, and set type to Thin. (See "Opening printing preferences" on page 42.)
An unknown image repetitively appears on a few sheets or loose toner, light print, or contamination occurs.	<p>Your machine is probably being used at an altitude of 1,000 m (3,281 ft) or above. The high altitude may affect the print quality, such as loose toner or light imaging. Change the correct altitude setting to your machine. (See "Altitude adjustment (ML-2580 Series only)" on page 34.)</p>

Common Windows problems

CONDITION	SUGGESTED SOLUTIONS
"File in Use" message appears during installation.	<p>Exit all software applications. Remove all software from the startup group, then restart Windows. Reinstall the printer driver.</p>
"General Protection Fault", "Exception OE", "Spool 32", or "Illegal Operation" messages appear.	<p>Close all other applications, reboot Windows and try printing again.</p>
"Fail To Print", "A printer timeout error occurred" messages appear.	<p>These messages may appear during printing. Just keep waiting until the machine finishes printing. If the message appears in ready mode or after printing has been completed, check the connection and/or whether an error has occurred.</p>

 Refer to Microsoft Windows 2000/XP/2003/Vista User's Guide that came with your computer for further information on Windows error messages.

Common Linux problems

CONDITION	SUGGESTED SOLUTIONS
The machine does not print.	<ul style="list-style-type: none"> Check if the printer driver is installed in your system. Open Unified Driver Configurator and switch to the Printers tab in Printers configuration window to look at the list of available machines. Make sure that your machine is displayed on the list. If not, open Add new printer wizard to set up your device. Check if the machine is started. Open Printers configuration and select your machine on the printers list. Look at the description in the Selected printer pane. If its status contains Stopped string, press the Start button. After that normal operation of the machine should be restored. The "stopped" status might be activated when some problems in printing occurred. Check if your application has special print option such as "-oraw". If "-oraw" is specified in the command line parameter, then remove it to print properly. For Gimp front-end, select "print" -> "Setup printer" and edit command line parameter in the command item.
The machine does not print whole pages, and output is printed on half the page.	It is a known problem that occurs when a color machine is used on version 8.51 or earlier of Ghostscript, 64-bit Linux OS, and has been reported to bugs.ghostscript.com as Ghostscript Bug 688252. The problem is solved in AFPL Ghostscript v. 8.52 or above. Download the latest version of AFPL Ghostscript from http://sourceforge.net/projects/ghostscript/ and install it to solve this problem.
I encounter error "Cannot open port device file" when printing a document.	Avoid changing print job parameters (via LPR GUI, for example) while a print job is in progress. Known versions of CUPS server break the print job whenever print options are changed and then try to restart the job from the beginning. Since Unified Linux Driver locks the port while printing, the abrupt termination of the driver keeps the port locked and unavailable for subsequent print jobs. If this situation occurs, try to release the port by selecting Release port in Port configuration window.

 Refer to Linux User's Guide that came with your computer for further information on Linux error messages.

Common Macintosh problems

CONDITION	SUGGESTED SOLUTIONS
The machine does not print PDF files correctly. Some parts of graphics, text, or illustrations are missing.	Printing the PDF file as an image may enable the file to print. Turn on Print As Image from the Acrobat printing options.  It will take longer to print when you print a PDF file as an image.
The document has printed, but the print job has not disappeared from the spooler in Mac OS X10.3.2.	Update your MAC OS to OS MAC OS X 10.3.3 or higher.
Some letters are not displayed normally during the Cover page printing.	Mac OS cannot create the font during the Cover page printing. The English alphabet and numbers are displayed normally on the Cover page.
When printing a document in Macintosh with Acrobat Reader 6.0 or higher, colors print incorrectly.	Make sure that the resolution setting in your machine driver matches the one in Acrobat Reader.

 Refer to Macintosh User's Guide that came with your computer for further information on Macintosh error messages.

supplies

This chapter provides information on purchasing supplies and maintenance parts available for your machine.

This chapter includes:

- How to purchase
- Available supplies

 Available accessories may differ from country to country. Contact your sales representatives to obtain the list of available accessories.

HOW TO PURCHASE

To order Samsung-authorized supplies, accessories and, maintenance parts, contact your local Samsung dealer or the retailer where you purchased your machine. You can also visit www.samsung.com/supplies, select your country/region, and obtain information on calling for service.

AVAILABLE SUPPLIES

When supplies reach their lifespan, you can order the following types of supplies for your machine:

TYPE	AVERAGE YIELD ^a	PART NAME
Standard yield toner cartridge	Approx. 1,500 pages	<ul style="list-style-type: none">• MLT-D105S• Region A^b: MLT-D1052S• Region B^c: MLT-D1053S
High yield toner cartridge	Approx. 2,500 pages	<ul style="list-style-type: none">• MLT-D105L• Region A^b: MLT-D1052L• Region B^c: MLT-D1053L

a. Declared yield value in accordance with ISO/IEC 19752.

b. Region A: Albania, Austria, Belgium, Bosnia, Bulgaria, Croatia, Cyprus, Czech Republic, Denmark, Finland, France, Germany, Greece, Hungary, Italy, Macedonia, Netherlands, Norway, Poland, Portugal, Romania, Serbia, Slovakia, Slovenia, Spain, Sweden, Switzerland, UK.

c. Region B: China only.

To replace a toner cartridge: (See "Replacing the toner cartridge" on page 65.)

 Depending on the options and job mode used, the toner cartridge's lifespan may differ.

 You must purchase supplies, including toner cartridges, in the same country where you purchased your machine. Otherwise, supplies will be incompatible with your machine since the system configuration of these vary from country to country.

 Samsung does not recommend using non-genuine Samsung toner

- Available maintenance parts
- Replacing the toner cartridge

cartridge such as refilled or remanufactured. Samsung cannot guarantee non-genuine Samsung toner cartridge's quality. Service or repair required as a result of using non-genuine Samsung toner cartridges will not be covered under the machine warranty.

AVAILABLE MAINTENANCE PARTS

To avoid print quality and paper feed problems resulting from worn parts and to maintain your machine in top working condition, the following parts will need to be replaced after printing the specified number of pages or when the life span of each item has expired.

PARTS	AVERAGE YIELD ^a	PART NAME
Transfer roller	Approx. 50,000 pages	ROLLER-TRANSFER
Fuser unit	Approx. 50,000 pages	FUSER
Pickup roller	Approx. 50,000 pages	ROLLER-PICK UP
Cassette unit	Approx. 50,000 pages	CASSETTE

a. It will be affected by operating system used, computing performance, application software, connecting method, media type, media size and job complexity.

To purchase maintenance parts, contact the source where you bought the machine.

Replacing maintenance parts can be performed only by an authorized service provider, dealer, or the retailer where you bought the machine. The warranty does not cover the replacement of any maintenance parts after their lifespan.

REPLACING THE TONER CARTRIDGE

 Click this link to open an animation about replacing a toner cartridge.

When the toner cartridge reaches its estimated cartridge life.

- The Smart Panel program window appears on the computer telling you the toner cartridge needs to be replaced.
- The machine stops printing.

At this stage, the toner cartridge needs to be replaced. Check the type of the toner cartridge for your machine. (See "Available supplies" on page 65.)

1. Open the front cover.
2. Pull the toner cartridge out.

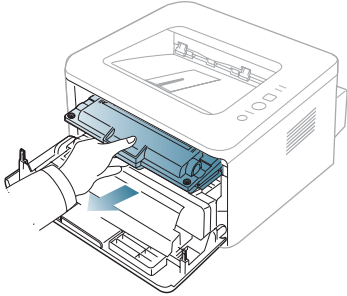

3. Take a new toner cartridge out of its package.
4. Remove the paper protecting the toner cartridge by pulling the packing tape.

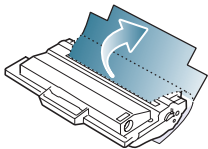

5. Locate the sealing tape at the end of the toner cartridge. Carefully pull the tape completely out of the cartridge and discard it.

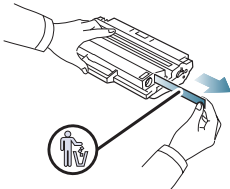

- The sealing tape should be longer than 60 cm when correctly removed.
- Holding the toner cartridge, pull the sealing tape straight to remove it from the cartridge. Be careful not to cut the tape. If this happens, you cannot use the toner cartridge.
- Refer to the helpful pictures on the cartridge wrapping paper.

6. Slowly shake the cartridge five or six times to distribute the toner evenly inside the cartridge. It will assure maximum copies per cartridge.

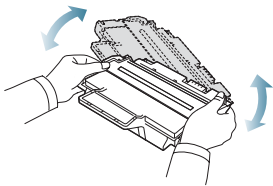

- If toner gets on your clothing, wipe it off with a dry cloth and wash clothing in cold water. Hot water sets toner into fabric.

- Do not touch the green underside of the toner cartridge. Use the handle on the cartridge to avoid touching this area.

7. Hold the toner cartridge by the handle and slowly insert the cartridge into the opening in the machine.

Tabs on the sides of the cartridge and corresponding grooves within the machine will guide the cartridge into the correct position until it locks into place completely.

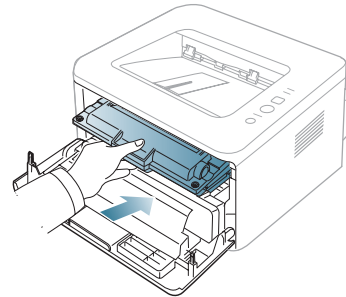

8. Close the front cover. Make sure that the cover is securely closed.

specifications

This chapter guides you about this machine's specifications such as various features.

This chapter include:

- General specifications
- Printer specifications
- Print media specifications

GENERAL SPECIFICATIONS

ITEM	DESCRIPTION
Paper input capacity	<ul style="list-style-type: none"> • Tray: 250-sheet tray for plain paper, 80 g/m² (20 lb bond) • Manual tray: 1 sheet (See "Print media specifications" on page 69.)
Paper output capacity (Face down)	<ul style="list-style-type: none"> • ML-1910 Series: 50 sheets 80 g/m² (20 lb bond) • ML-2525 Series, ML-2580 Series: 100 sheets 80 g/m² (20 lb bond)
Power rating	AC 110 - 127 V or AC 220 - 240 V See the Rating label on the machine for the correct voltage, frequency (hertz) and type of current for your machine.
Power consumption	<ul style="list-style-type: none"> • Average operating mode: Less than 400 W • Ready mode: Less than 60 W • Power save mode: Less than 6.5 W • Power off mode: Less than 0.8 W
Noise Level^a	<ul style="list-style-type: none"> • Ready mode: 26 dB(A) • Printing mode: 50 dB(A)
Boot-up time^b	Less than 30 seconds
Operating environment	<ul style="list-style-type: none"> • Temperature: 10 to 32 °C (50 to 90 °F) • Humidity: 20 to 80% RH
Toner cartridge life^c	<ul style="list-style-type: none"> • ML-1910 Series: Shipped with 700 pages starter toner cartridge^d. • ML-2525 Series, ML-2580 Series: Shipped with 1,000 pages starter toner cartridge^d. (See "Available supplies" on page 65.)
Memory	<ul style="list-style-type: none"> • ML-1910 Series, ML-2525 Series: 8 MB (Non-extendable) • ML-2580 Series: 64 MB (Non-extendable)
External dimension (W x D x H)	360 x 367 x 197 mm (14.17 x 14.45 x 7.76 inches)
Weight (Including consumables)	<ul style="list-style-type: none"> • ML-1910 Series: 6.8 Kg (15.00 lbs) • ML-2525 Series, ML-2580 Series: 6.8 Kg (21.38 lbs)
Package weight	<ul style="list-style-type: none"> • ML-1910 Series: Paper: 1.46 Kg (3.22 lbs), Plastic: 0.36 Kg (0.80 lbs) • ML-2525 Series, ML-2580 Series: Paper: 1.46 Kg (3.22 lbs), Plastic: 0.36 Kg (0.80 lbs)
Fusing temperature	180 °C (356 °F)

a. Sound Pressure Level, ISO 7779. Configuration tested: machine basic installation, A4 paper, simplex printing.

b. Boot-up time is the time that takes from the power on to the ready mode.

c. Declared yield value in accordance with ISO/IEC 19752. The number of pages may be affected by operating environment, printing interval, media type, and media size.

d. It varies depending on the product configuration.

PRINTER SPECIFICATIONS

ITEM	DESCRIPTION
Printing method	Laser beam printing
Printing speed ^a	<ul style="list-style-type: none"> • ML-1910 Series: Up to 18 ppm (A4), 19 ppm (Letter) • ML-2525 Series, ML-2580 Series: Up to 24 ppm (A4), 24 ppm (Letter)
First print out time	9 seconds (from ready)
Print resolution	<ul style="list-style-type: none"> • ML-1910 Series, ML-2525 Series: Up to 1,200 x 600 dpi effective output • ML-2580 Series: Up to 1,200 x 1,200 dpi effective output
Printer language	<ul style="list-style-type: none"> • ML-1910 Series, ML-2525 Series: SPL • ML-2580 Series: PCL5e, PCL6, SPL, IBM ProPrinter, EPSON
OS compatibility ^b	<ul style="list-style-type: none"> • Windows: 2000/XP/2003/2008/Vista • Various Linux OS (See "Linux" on page 24.) • Macintosh: Mac OS X 10.3~10.6
Interface	<ul style="list-style-type: none"> • ML-1910 Series: Compatible with USB 2.0 • ML-2525 Series: High speed USB 2.0 • ML-2580 Series: High speed USB 2.0, Ethernet 10/100 Base TX (embedded type)

a. It will be affected by operating system used, computing performance, application software, connecting method, media type, media size and job complexity.

b. Visit www.samsung.com/printer to download the latest software version.

PRINT MEDIA SPECIFICATIONS

TYPE	SIZE	DIMENSIONS	PRINT MEDIA WEIGHT ^a /CAPACITY ^b	
			TRAY1	MANUAL TRAY
Plain paper	Letter	216 x 279 mm (8.50 x 11.00 inches)	60 to 120 g/m ² (16 to 32 lb bond) • 250 sheets of 80g/m ² (20 lb bond)	60 to 220 g/m ² (16 to 43 lb bond) • 1 sheet stacking
	Legal	216 x 356 mm (8.50 x 14.00 inches)		
	US Folio	216 x 330 mm (8.50 x 13.00 inches)		
	A4	210 x 297 mm (8.27 x 11.69 inches)		
	Oficio	216 x 343 mm (8.50 x 13.50 inches)		
	JIS B5	182 x 257 mm (7.17 x 10.12 inches)	60 to 90 g/m ² (16 to 24 lb bond) • 150 sheets of 80 g/m ² (20 lb bond)	
	ISO B5	176 x 250 mm (6.93 x 9.84 inches)		
	Executive	184 x 267 mm (7.25 x 0 inches)		
	A5	148 x 210 mm (5.83 x 8.27 inches)		
	A6	105 x 148 mm (4.13 x 5.83 inches)		
Envelope	Envelope Monarch	98 x 191 mm (3.87 x 7.50 inches)	Not available in tray1.	75 to 90 g/m ² (20 to 24 lb bond) • 1 sheet stacking
	Envelope No. 10	105 x 241 mm (4.12 x 9.50 inches)		
	Envelope DL	110 x 220 mm (4.33 x 8.66 inches)		
	Envelope C5	162 x 229 mm (6.38 x 9.02 inches)		
	Envelope C6	114 x 162 mm (4.49 x 6.38 inches)		
Thick paper	Refer to the Plain paper section	Refer to the Plain paper section	90 g/m ² (24 lb bond)	90 g/m ² (24 lb bond) • 1 sheet stacking
Thin paper	Refer to the Plain paper section	Refer to the Plain paper section	60 to 70 g/m ² (16 to 19 lb bond)	60 to 70 g/m ² (16 to 19 lb bond) • 1 sheet stacking
Transparency	Refer to the Plain paper section	Refer to the Plain paper section	Not available in tray1.	138 to 146 g/m ² (36.81 to 38.91 lb bond) • 1 sheet stacking
Labels ^c	Letter, Legal, US Folio, A4, JIS B5, ISO B5, Executive, A5, Statement	Refer to the Plain paper section	Not available in tray1.	120 to 150 g/m ² (32 to 40 lb bond) • 1 sheet stacking
Card stock	Letter, Legal, US Folio, A4, JIS B5, ISO B5, Executive, A5, Statement, PostCard 4x6	Refer to the Plain paper section	Not available in tray1.	105 to 163 g/m ² (28 to 43 lb bond) • 1 sheet stacking
Minimum size (custom)		76 x 127 mm (3.00 x 5.00 inches)	60 to 163 g/m ² (16 to 43 lb bond)	
Maximum size (custom)		216 x 356 mm (8.50 x 14.02 inches)		

a. If media weight is over 120 g/m² (32 lb), load a paper into the tray one by one.

b. Maximum capacity may differ depending on media weight, thickness, and environmental conditions.

c. Smoothness: 100 to 250 (sheffield)

contact samsung worldwide

If you have any comments or questions regarding Samsung products, contact the Samsung customer care center.

COUNTRY/REGION	CUSTOMER CARE CENTER	WEB SITE
ARGENTINE	0800-333-3733	www.samsung.com/ar
AUSTRALIA	1300 362 603	www.samsung.com/au
AUSTRIA	0810-SAMSUNG (7267864, € 0.07/min)	www.samsung.com/at
BELGIUM	02 201 2418	www.samsung.com/be (Dutch) www.samsung.com/be_fr (French)
BRAZIL	0800-124-421 4004-0000	www.samsung.com/br
CANADA	1-800-SAMSUNG (726-7864)	www.samsung.com/ca
CHILE	800-SAMSUNG (726-7864)	www.samsung.com/cl
CHINA	800-810-5858 400-810-5858 010-6475 1880	www.samsung.com/cn
COLOMBIA	01-8000112112	www.samsung.com.co
COSTA RICA	0-800-507-7267	www.samsung.com/latin
CZECH REPUBLIC	800-SAMSUNG (800-726786) Samsung Zrt., česká organizační složka, Oasis Florenc, Sokolovská394/17, 180 00, Praha 8	www.samsung.com/cz
DENMARK	8-SAMSUNG (7267864)	www.samsung.com/dk
ECUADOR	1-800-10-7267	www.samsung.com/latin
EL SALVADOR	800-6225	www.samsung.com/latin
ESTONIA	800-7267	www.samsung.com/ee
KAZAKHSTAN	8-10-800-500-55-500	www.samsung.com/kz_ru
KYRGYZSTAN	00-800-500-55-500	
FINLAND	30-6227 515	www.samsung.com/fi
FRANCE	01 4863 0000	www.samsung.com/fr
GERMANY	01805 - SAMSUNG (726-7864 € 0,14/min)	www.samsung.de
GUATEMALA	1-800-299-0013	www.samsung.com/latin
HONDURAS	800-7919267	www.samsung.com/latin
HONG KONG	3698-4698	www.samsung.com/hk
HUNGARY	06-80-SAMSUNG (726-7864)	www.samsung.com/hu

COUNTRY/REGION	CUSTOMER CARE CENTER	WEB SITE
INDIA	3030 8282 1800 110011 1800 3000 8282	www.samsung.com/in
INDONESIA	0800-112-8888	www.samsung.com/id
ITALIA	800-SAMSUNG(726-7864)	www.samsung.com/it
JAMAICA	1-800-234-7267	www.samsung.com/latin
JAPAN	0120-327-527	www.samsung.com/jp
LATVIA	8000-7267	www.samsung.com/lv
LITHUANIA	8-800-77777	www.samsung.com/lt
LUXEMBURG	02 261 03 710	www.samsung.com/lu
MALAYSIA	1800-88-9999	www.samsung.com/my
MEXICO	01-800-SAMSUNG (726-7864)	www.samsung.com/mx
NETHERLANDS	0900-SAMSUNG (0900-7267864) (€ 0,10/min)	www.samsung.com/nl
NEW ZEALAND	0800 SAMSUNG (0800 726 786)	www.samsung.com/nz
NICARAGUA	00-1800-5077267	www.samsung.com/latin
NORWAY	3-SAMSUNG (7267864)	www.samsung.com/no
PANAMA	800-7267	www.samsung.com/latin
PHILIPPINES	1800-10-SAMSUNG (726-7864) 1-800-3-SAMSUNG (726-7864) 02-5805777	www.samsung.com/ph
POLAND	0 801 1SAMSUNG (172678) 022-607-93-33	www.samsung.com/pl
PORTUGAL	80820-SAMSUNG (726-7864)	www.samsung.com/pt
PUERTO RICO	1-800-682-3180	www.samsung.com/latin
REP. DOMINICA	1-800-751-2676	www.samsung.com/latin
EIRE	0818 717 100	www.samsung.com/ie
RUSSIA	8-800-555-55-55	www.samsung.ru
SINGAPORE	1800-SAMSUNG (726-7864)	www.samsung.com/sg
SLOVAKIA	0800-SAMSUNG (726-7864)	www.samsung.com/sk

COUNTRY/REGION	CUSTOMER CARE CENTER	WEB SITE
SOUTH AFRICA	0860 SAMSUNG (726-7864)	www.samsung.com/za
SPAIN	902-1-SAMSUNG(902 172 678)	www.samsung.com/es
SWEDEN	075-SAMSUNG (726 78 64)	www.samsung.com/se
SWITZERLAND	0848-SAMSUNG (7267864, CHF 0.08/min)	www.samsung.com/ch
TADJIKISTAN	8-10-800-500-55-500	
TAIWAN	0800-329-999	www.samsung.com/tw
THAILAND	1800-29-3232 02-689-3232	www.samsung.com/th
TRINIDAD & TOBAGO	1-800-SAMSUNG (726-7864)	www.samsung.com/latin
TURKEY	444 77 11	www.samsung.com/tr
U.A.E	800-SAMSUNG (726-7864) 8000-4726	www.samsung.com/ae
U.K	0845 SAMSUNG (726-7864)	www.samsung.com/uk
U.S.A	1-800-SAMSUNG (7267864)	www.samsung.com/us
UKRAINE	8-800-502-0000	www.samsung.ua
UZBEKISTAN	8-10-800-500-55-500	www.samsung.com/kz_ru
VENEZUELA	0-800-100-5303	www.samsung.com/latin
VIETNAM	1 800 588 889	www.samsung.com/vn

glossary

 The following glossary helps you get familiar with the product by understanding the terminologies commonly used with printing as well as mentioned in this user's guide.

802.11

802.11 is a set of standards for wireless local area network (WLAN) communication, developed by the IEEE LAN/MAN Standards Committee (IEEE 802).

802.11b/g

802.11b/g can share same hardware and use the 2.4 GHz band. 802.11b supports bandwidth up to 11 Mbps; 802.11g up to 54 Mbps. 802.11b/g devices may occasionally suffer interference from microwave ovens, cordless telephones, and Bluetooth devices.

Access point

Access Point or Wireless Access Point (AP or WAP) is a device that connects wireless communication devices together on wireless local area networks (WLAN), and acts as a central transmitter and receiver of WLAN radio signals.

ADF

An Automatic Document Feeder (ADF) is a mechanism that will automatically feed an original sheet of paper so that the machine can scan some amount of the paper at once.

AppleTalk

AppleTalk is a proprietary suite of protocols developed by Apple, Inc for computer networking. It was included in the original Macintosh (1984) and is now deprecated by Apple in favor of TCP/IP networking.

BIT Depth

A computer graphics term describing the number of bits used to represent the color of a single pixel in a bitmapped image. Higher color depth gives a broader range of distinct colors. As the number of bits increases, the number of possible colors becomes impractically large for a color map. 1-bit color is commonly called as monochrome or black and white.

BMP

A bitmapped graphics format used internally by the Microsoft Windows graphics subsystem (GDI), and used commonly as a simple graphics file format on that platform.

BOOTP

Bootstrap Protocol. A network protocol used by a network client to obtain its IP address automatically. This is usually done in the bootstrap process of computers or operating systems running on them. The BOOTP servers assign the IP address from a pool of addresses to each client. BOOTP enables 'diskless workstation' computers to obtain an IP address prior to loading any advanced operating system.

CCD

Charge Coupled Device (CCD) is a hardware which enables the scan job. CCD Locking mechanism is also used to hold the CCD module to prevent any damage when you move the machine.

Collation

Collation is a process of printing a multiple-copy job in sets. When collation is selected, the device prints an entire set before printing additional copies.

Control Panel

A control panel is a flat, typically vertical, area where control or monitoring instruments are displayed. They are typically found in front of the machine.

Coverage

It is the printing term used for a toner usage measurement on printing. For example, 5% coverage means that an A4 sided paper has about 5% image or text on it. So, if the paper or original has complicated images or lots of text on it, the coverage will be higher and at the same time, a toner usage will be as much as the coverage.

CSV

Comma Separated Values (CSV). A type of file format, CSV is used to exchange data between disparate applications. The file format, as it is used in Microsoft Excel, has become a pseudo standard throughout the industry, even among non-Microsoft platforms.

DADF

A Duplex Automatic Document Feeder (DADF) is a mechanism that will automatically feed and flip over an original sheet of paper so that the machine can scan on both sides of the paper.

Default

The value or setting that is in effect when taking a printer out of its box state, reset, or initialized.

DHCP

A Dynamic Host Configuration Protocol (DHCP) is a client-server networking protocol. A DHCP server provides configuration parameters specific to the DHCP client host requesting, generally, information required by the client host to participate on an IP network. DHCP also provides a mechanism for allocation of IP addresses to client hosts.

DIMM

Dual Inline Memory Module (DIMM), a small circuit board that holds memory. DIMM stores all the data within the machine like printing data, received fax data.

DNS

The Domain Name Server (DNS) is a system that stores information associated with domain names in a distributed database on networks, such as the Internet.

Dot Matrix Printer

A dot matrix printer refers to a type of computer printer with a print head that runs back and forth on the page and prints by impact, striking an ink-soaked cloth ribbon against the paper, much like a typewriter.

DPI

Dots Per Inch (DPI) is a measurement of resolution that is used for scanning and printing. Generally, higher DPI results in a higher resolution, more visible detail in the image, and a larger file size.

DRPD

Distinctive Ring Pattern Detection. Distinctive Ring is a telephone company service which enables a user to use a single telephone line to answer several different telephone numbers.

Duplex

A mechanism that will automatically flip over a sheet of paper so that the machine can print (or scan) on both sides of the paper. A printer equipped with a Duplex can print double-sided of paper.

Duty Cycle

Duty cycle is the page quantity which does not affect printer performance for a month. Generally the printer has the lifespan limitation such as pages per year. The lifespan means the average capacity of print-outs, usually within the warranty period. For example, if the duty cycle is 48,000 pages per month assuming 20 working days, a printer limits 2,400 pages a day.

ECM

Error Correction Mode (ECM) is an optional transmission mode built into Class 1 fax machines or fax modems. It automatically detects and corrects errors in the fax transmission process that are sometimes caused by telephone line noise.

Emulation

Emulation is a technique of one machine obtaining the same results as another.

An emulator duplicates the functions of one system with a different system, so that the second system behaves like the first system. Emulation focuses on exact reproduction of external behavior, which is in contrast to simulation, which concerns an abstract model of the system being simulated, often considering its internal state.

Ethernet

Ethernet is a frame-based computer networking technology for local area networks (LANs). It defines wiring and signaling for the physical layer, and frame formats and protocols for the media access control (MAC)/data link layer of the OSI model. Ethernet is mostly standardized as IEEE 802.3. It has become the most widespread LAN technology in use during the 1990s to the present.

EtherTalk

A suite of protocols developed by Apple Computer for computer networking. It was included in the original Macintosh (1984) and is now deprecated by Apple in favor of TCP/IP networking.

FDI

Foreign Device Interface (FDI) is a card installed inside the machine to allow a third party device such as a coin operated device or a card reader. Those devices allow the pay-for-print service on your machine.

FTP

A File Transfer Protocol (FTP) is a commonly used protocol for exchanging files over any network that supports the TCP/IP protocol (such as the Internet or an intranet).

Fuser Unit

The part of a laser printer that melts the toner onto the print media. It consists of a hot roller and a back-up roller. After toner is transferred onto the paper, the fuser unit applies heat and pressure to ensure that the toner stays on the paper permanently, which is why paper is warm when it comes out of a laser printer.

Gateway

A connection between computer networks, or between a computer network and a telephone line. It is very popular, as it is a computer or a network that allows access to another computer or network.

Grayscale

A shades of gray that represent light and dark portions of an image when color images are converted to grayscale; colors are represented by various shades of gray.

Halftone

An image type that simulates grayscale by varying the number of dots. Highly colored areas consist of a large number of dots, while lighter areas consist of a smaller number of dots.

HDD

Hard Disk Drive (HDD), commonly referred to as a hard drive or hard disk, is a non-volatile storage device which stores digitally-encoded data on rapidly rotating platters with magnetic surfaces.

IEEE

The Institute of Electrical and Electronics Engineers (IEEE) is an international non-profit, professional organization for the advancement of technology related to electricity.

IEEE 1284

The 1284 parallel port standard was developed by the Institute of Electrical and Electronics Engineers (IEEE). The term "1284-B" refers to a specific connector type on the end of the parallel cable that attaches to the peripheral (for example, a printer).

Intranet

A private network that uses Internet Protocols, network connectivity, and possibly the public telecommunication system to securely share part of an organization's information or operations with its employees. Sometimes the term refers only to the most visible service, the internal website.

IP address

An Internet Protocol (IP) address is a unique number that devices use in order to identify and communicate with each other on a network utilizing the Internet Protocol standard.

IPM

The Images Per Minute (IPM) is a way of measuring the speed of a printer. An IPM rate indicates the number of single-sided sheets a printer can complete within one minute.

IPP

The Internet Printing Protocol (IPP) defines a standard protocol for printing as well as managing print jobs, media size, resolution, and so forth. IPP can be used locally or over the Internet to hundreds of printers, and also supports access control, authentication, and encryption, making it a much more capable and secure printing solution than older ones.

IPX/SPX

IPX/SPX stands for Internet Packet Exchange/Sequenced Packet Exchange. It is a networking protocol used by the Novell NetWare operating systems. IPX and SPX both provide connection services similar to TCP/IP, with the IPX protocol having similarities to IP, and SPX having similarities to TCP. IPX/SPX was primarily designed for local area networks (LANs), and is a very efficient protocol for this purpose (typically its performance exceeds that of TCP/IP on a LAN).

ISO

The International Organization for Standardization (ISO) is an international standard-setting body composed of representatives from national standards bodies. It produces world-wide industrial and commercial standards.

ITU-T

The International Telecommunication Union is an international organization established to standardize and regulate international radio and telecommunications. Its main tasks include standardization, allocation of the radio spectrum, and organizing interconnection arrangements between different countries to allow international phone calls. A -T out of ITU-T indicates telecommunication.

ITU-T No. 1 chart

Standardized test chart published by ITU-T for document facsimile transmissions.

JBIG

Joint Bi-level Image Experts Group (JBIG) is an image compression standard with no loss of accuracy or quality, which was designed for

compression of binary images, particularly for faxes, but can also be used on other images.

JPEG

Joint Photographic Experts Group (JPEG) is a most commonly used standard method of lossy compression for photographic images. It is the format used for storing and transmitting photographs on the World Wide Web.

LDAP

The Lightweight Directory Access Protocol (LDAP) is a networking protocol for querying and modifying directory services running over TCP/IP.

LED

A Light-Emitting Diode (LED) is a semiconductor device that indicates the status of a machine.

MAC address

Media Access Control (MAC) address is a unique identifier associated with a network adapter. MAC address is a unique 48-bit identifier usually written as 12 hexadecimal characters grouped in pairs (e. g., 00-00-0c-34-11-4e). This address is usually hard-coded into a Network Interface Card (NIC) by its manufacturer, and used as an aid for routers trying to locate machines on large networks.

MFP

Multi Function Peripheral (MFP) is an office machine that includes the following functionality in one physical body, so as to have a printer, a copier, a fax, a scanner and etc.

MH

Modified Huffman (MH) is a compression method for decreasing the amount of data that needs to be transmitted between the fax machines to transfer the image recommended by ITU-T T.4. MH is a codebook-based run-length encoding scheme optimized to efficiently compress white space. As most faxes consist mostly of white space, this minimizes the transmission time of most faxes.

MMR

Modified Modified READ (MMR) is a compression method recommended by ITU-T T.6.

Modem

A device that modulates a carrier signal to encode digital information, and also demodulates such a carrier signal to decode transmitted information.

MR

Modified Read (MR) is a compression method recommended by ITU-T T.4. MR encodes the first scanned line using MH. The next line is compared to the first, the differences determined, and then the differences are encoded and transmitted.

NetWare

A network operating system developed by Novell, Inc. It initially used cooperative multitasking to run various services on a PC, and the network protocols were based on the archetypal Xerox XNS stack. Today NetWare supports TCP/IP as well as IPX/SPX.

OPC

Organic Photo Conductor (OPC) is a mechanism that makes a virtual image for print using a laser beam emitted from a laser printer, and it is usually green or gray colored and a cylinder shaped.

An exposing unit of a drum is slowly worn away by its usage of the printer, and it should be replaced appropriately since it gets scratches from grits of a paper.

Originals

The first example of something, such as a document, photograph or text, etc, which is copied, reproduced or translated to produce others, but which is not itself copied or derived from something else.

OSI

Open Systems Interconnection (OSI) is a model developed by the International Organization for Standardization (ISO) for communications. OSI offers a standard, modular approach to network design that divides the required set of complex functions into manageable, self-contained, functional layers. The layers are, from top to bottom, Application, Presentation, Session, Transport, Network, Data Link and Physical.

PABX

A private automatic branch exchange (PABX) is an automatic telephone switching system within a private enterprise.

PCL

Printer Command Language (PCL) is a Page Description Language (PDL) developed by HP as a printer protocol and has become an industry standard. Originally developed for early inkjet printers, PCL has been released in varying levels for thermal, matrix printer, and page printers.

PDF

Portable Document Format (PDF) is a proprietary file format developed by Adobe Systems for representing two dimensional documents in a device independent and resolution independent format.

PostScript

PostScript (PS) is a page description language and programming language used primarily in the electronic and desktop publishing areas. - that is run in an interpreter to generate an image.

Printer Driver

A program used to send commands and transfer data from the computer to the printer.

Print Media

The media like paper, envelopes, labels, and transparencies which can be used on a printer, a scanner, a fax or, a copier.

PPM

Pages Per Minute (PPM) is a method of measurement for determining how fast a printer works, meaning the number of pages a printer can produce in one minute.

PRN file

An interface for a device driver, this allows software to interact with the device driver using standard input/output system calls, which simplifies many tasks.

Protocol

A convention or standard that controls or enables the connection, communication, and data transfer between two computing endpoints.

PS

See PostScript.

PSTN

The Public-Switched Telephone Network (PSTN) is the network of the world's public circuit-switched telephone networks which, on industrial premises, is usually routed through the switchboard.

RADIUS

Remote Authentication Dial In User Service (RADIUS) is a protocol for remote user authentication and accounting. RADIUS enables centralized management of authentication data such as usernames and passwords using an AAA (authentication, authorization, and accounting) concept to manage network access.

Resolution

The sharpness of an image, measured in Dots Per Inch (DPI). The higher the dpi, the greater the resolution.

SMB

Server Message Block (SMB) is a network protocol mainly applied to share files, printers, serial ports, and miscellaneous communications between nodes on a network. It also provides an authenticated Inter-process communication mechanism.

SMTP

Simple Mail Transfer Protocol (SMTP) is the standard for e-mail transmissions across the Internet. SMTP is a relatively simple, text-based protocol, where one or more recipients of a message are specified, and then the message text is transferred. It is a client-server protocol, where the client transmits an email message to the server.

SSID

Service Set Identifier (SSID) is a name of a wireless local area network (WLAN). All wireless devices in a WLAN use the same SSID in order to communicate with each other. The SSIDs are case-sensitive and have a maximum length of 32 characters.

Subnet Mask

The subnet mask is used in conjunction with the network address to determine which part of the address is the network address and which part is the host address.

TCP/IP

The Transmission Control Protocol (TCP) and the Internet Protocol (IP); the set of communications protocols that implement the protocol stack on which the Internet and most commercial networks run.

TCR

Transmission Confirmation Report (TCR) provides details of each transmission such as job status, transmission result and number of pages sent. This report can be set to print after each job or only after failed transmissions.

TIFF

Tagged Image File Format (TIFF) is a variable-resolution bitmapped image format. TIFF describes image data that typically come from scanners. TIFF images make use of tags, keywords defining the characteristics of the image that is included in the file. This flexible and platform-independent format can be used for pictures that have been made by various image processing applications.

Toner Cartridge

A kind of bottle within a machine like printer which contains toner. Toner is a powder used in laser printers and photocopiers, which forms the text and images on the printed paper. Toner can be melted by the heat of the fuser, causing it to bind to the fibers in the paper.

TWAIN

An industry standard for scanners and software. By using a TWAIN-compliant scanner with a TWAIN-compliant program, a scan can be initiated from within the program.; an image capture API for Microsoft Windows and Apple Macintosh operating systems.

UNC Path

Uniform Naming Convention (UNC) is a standard way to access network shares in Window NT and other Microsoft products. The format of a UNC path is: \\<servername>\<sharename>\<Additional directory>

URL

Uniform Resource Locator (URL) is the global address of documents and resources on the Internet. The first part of the address indicates what protocol to use, the second part specifies the IP address or the domain name where the resource is located.

USB

Universal Serial Bus (USB) is a standard that was developed by the USB Implementers Forum, Inc., to connect computers and peripherals. Unlike the parallel port, USB is designed to concurrently connect a single computer USB port to multiple peripherals.

Watermark

A watermark is a recognizable image or pattern in paper that appears lighter when viewed by transmitted light. Watermarks were first introduced in Bologna, Italy in 1282; they have been used by papermakers to identify their product, and also on postage stamps, currency, and other government documents to discourage counterfeiting.

WEP

Wired Equivalent Privacy (WEP) is a security protocol specified in IEEE 802.11 to provide the same level of security as that of a wired LAN. WEP provides security by encrypting data over radio so that it is protected as it is transmitted from one end point to another.

WIA

Windows Imaging Architecture (WIA) is an imaging architecture that is originally introduced in Windows Me and Windows XP. A scan can be initiated from within these operating systems by using a WIA-compliant scanner.

WPA

Wi-Fi Protected Access (WPA) is a class of systems to secure wireless (Wi-Fi) computer networks, which was created to improve upon the security features of WEP.

WPA-PSK

WPA-PSK (WPA Pre-Shared Key) is special mode of WPA for small business or home users. A shared key, or password, is configured in the wireless access point (WAP) and any wireless laptop or desktop devices. WPA-PSK generates a unique key for each session between a wireless client and the associated WAP for more advanced security.

index

A

adjusting
tray size 38

B

booklet printing 47
booklets 47

C

change percentage of your document 48
cleaning
inside 58
outside 58

cleaning a machine 58

control panel 24

convention 18

D

duplex printing (manual)
printer driver 47

F

favorites settings, for printing 46

features 20

machine features 71
print media feature 73, 45
supplied software 27

font setting 38

front view 22

G

glossary 76

I

information 7

J

jam

clearing paper 61
tips for avoiding paper jams 61

L

Linux

common Linux problems 68
driver installation for network connected
36, 30
printer properties 52, 51
supplied softwares 28
unified driver configurator 55, 34, 55

loading

paper in manual tray 41
special media 42

M

Macintosh

common Macintosh problems 68
driver installation for network connected
36, 30
printing 50
sharing a machine locally 31, 28
using SetIP 33, 55

maintenance parts 69

manual tray

loading 41
tips on using 41
using special media 42

N

network

driver installation
Linux 36
Macintosh 36
Windows 34
installing environment 32
IPv6 configuration 36
SetIP program 33, 34, 54
using a wired network 32

N-up printing

Macintosh 51
Windows 46

O

output support 44

overlay printing

create 49
delete 49
print 49

P

placing a machine 27
adjusting the altitude 38
spacing 27

poster, print 47

print media

card stock 44
envelope 42
glossy paper 44, 40
labels 43, 44
output support 73
photo paper 44
setting the default tray and paper
in the computer 38
transparency 43

print resolution, set

Linux 52
Macintosh 51

printer driver

features 45

printer properties

Linux 52

printing

changing the default print settings 49
fitting your document to a selected paper
size 48
Linux 51
Macintosh 50
multiple pages on one sheet of paper
Macintosh 51
Windows 46
poster 47
Windows 45, 47
50

printing a document

Linux 51
Macintosh 50

problems

paper feeding problems 63, 65

R

rear view 23

regulatory information 11

reports

network MAC address 54, 55

S

safety

information 7
symbols 7

service contact numbers 74

SetIP program 33, 34, 54

Smart Panel

font setting 38
general information 54

specifications

general 71
print media 73, 72

supplies

available supplies 69
estimated toner cartridge life 59
monitoring the supplies life 58
ordering 69
replacing toner cartridge 69

SyncThru Web Service

general information 53

T

toner cartridge

estimated life 59, 71
handling instructions 59
non-Samsung and refilled 59
redistributing toner 60, 69
storing 59

tray

adjusting the width and length 40
changing the tray size 40
loading paper in manual tray 41

U

understanding the control panel 25

cancel button 25

USB cable

driver installation 28

using help 46

using overlay in windows 48

using setip program

Linux 55
Macintosh 55
Windows 54

using watermarks in windows 48

W

watermark

create 48
delete 48
edit 48
print 48

Windows

common Windows problems 67
driver installation for network connected
34, 28
printing 45
sharing a machine locally 31, 28
using SetIP 33, 54